



SANITAIR FILLER

REPARATIESET ACRYL

SANITAIR FILLER

REPARATIESET ACRYL

Geleverd door Beltraco Benelux B.V.



Biestkampweg 21
5249 JV Rosmalen (NL)
T +31 (0)73 - 645 03 43
W www.beltraco.nl
E info@beltraco.nl

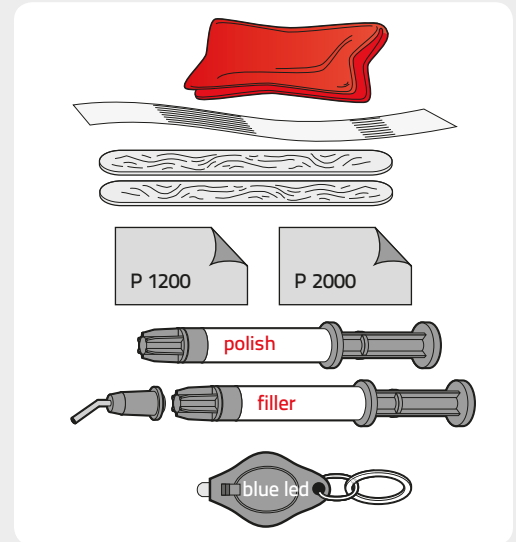

Inhoud pakket:

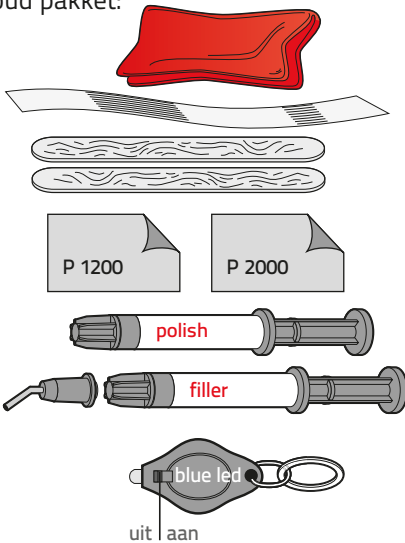

Eigen benodigdheden: alcohol en water

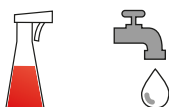

1

Reinigen met alcohol of spiritus

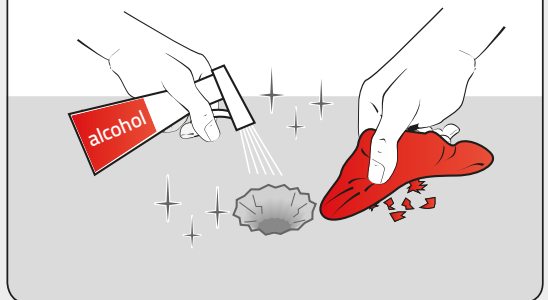

2

Microtip aanbrengen

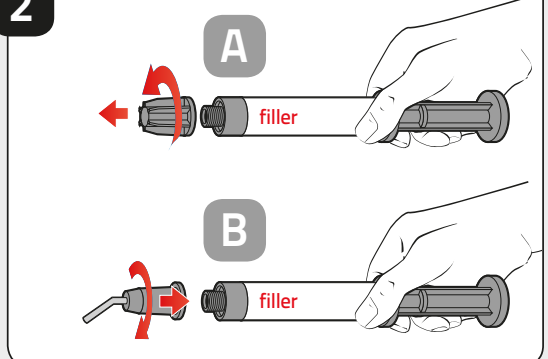

3

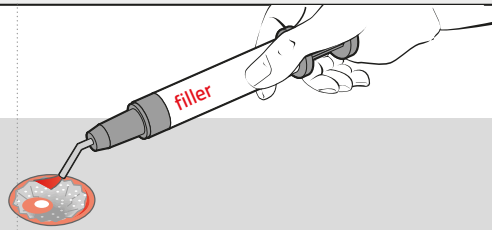

3.1 < 2mm filler

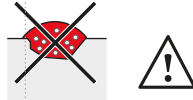
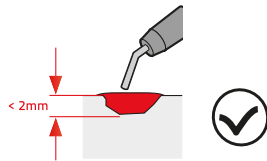

3.2 > 2mm filler

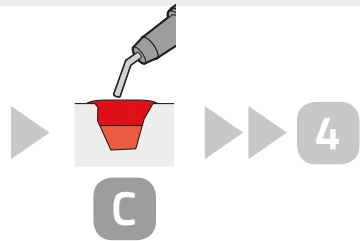
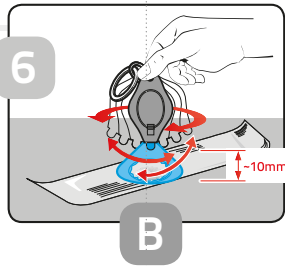
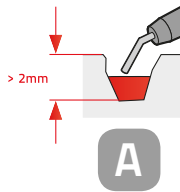

4

Transparante folie

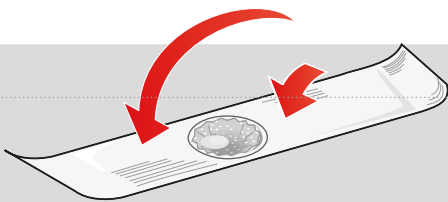

5

Eventuele luchtbelletjes verwijderen

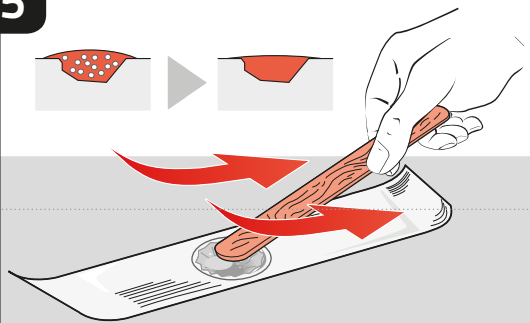

6

Uitharden

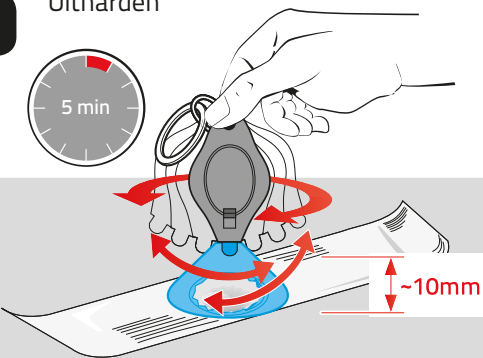

7

Folie verwijderen

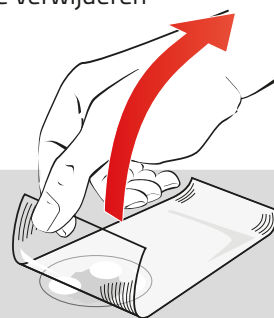

8

Voorzichtig schuren

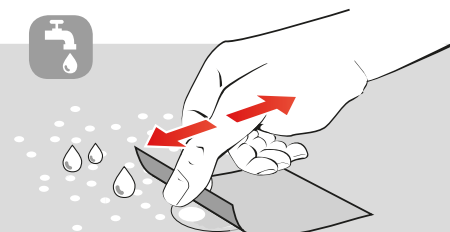

9

Op glans polijsten

