

WARNING:
CHOKING HAZARD—Small parts.
Not for children under 3 years.

SKU: 576044
ADULT ASSEMBLY REQUIRED
ADULT SUPERVISION REQUIRED



FASHION CLOSET ON-THE-GO!

CONTENTS

- | | | |
|---------------------------|-----------------------------------|--------------|
| A. Travel Closet | D. Travel Closet Stand (2 Pieces) | G. Glasses |
| B. 2 Storage Trays | E. 2 Wheels | H. Purse |
| C. 2 Reversible Backdrops | F. Bottom Foot | I. 6 Hangers |

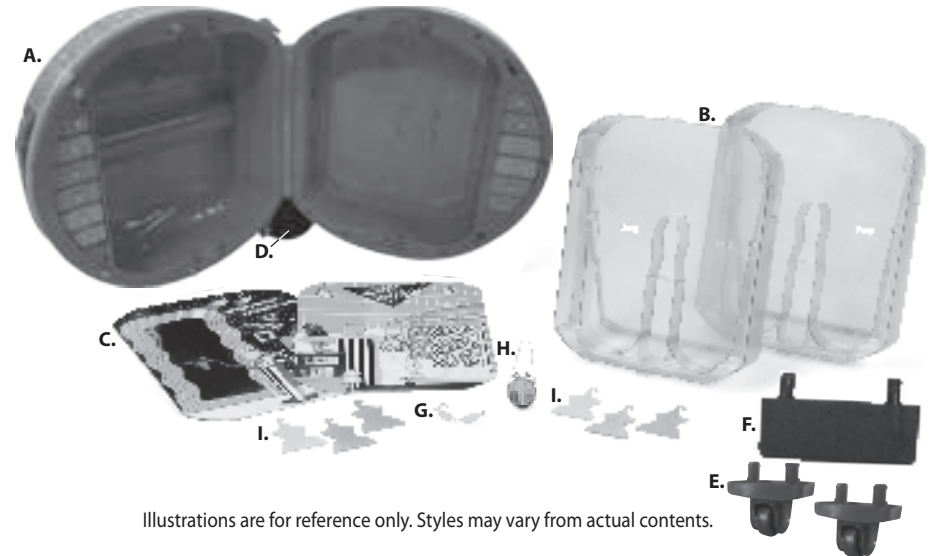

Illustrations are for reference only. Styles may vary from actual contents.

ASSEMBLY



Assembly should be done by an adult.
Wheels, bottom foot and travel closet stand are one-time snap. Once assembled, they can't be removed.
Take note of the orientation before attaching.

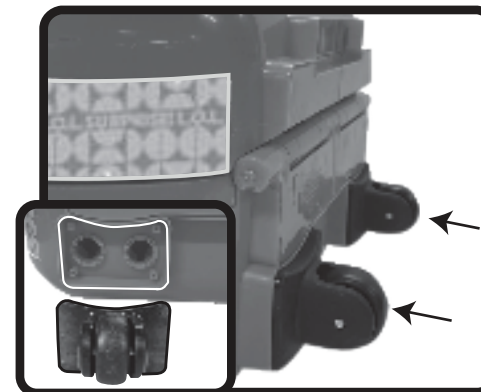

Close the travel closet and lay it on a flat surface. Then, insert the wheels. Align the curve of the wheel with the curve on the travel closet and snap in.

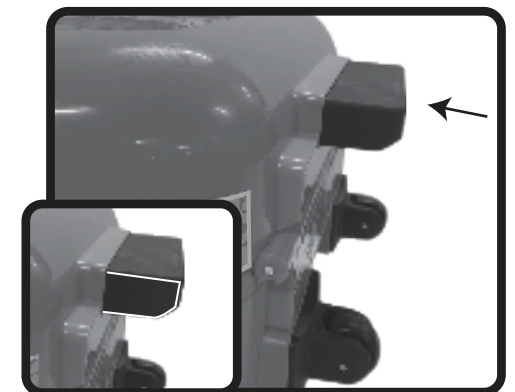

Insert the bottom foot. The flat surface should be facing the front of the travel closet.

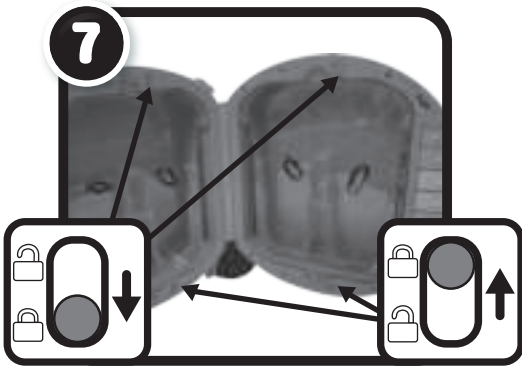

Insert the trays with backdrops into the travel closet and lock in place.

TIP: For correct placement of the trays, the trays have ribs on top that slide into the top of the closet.

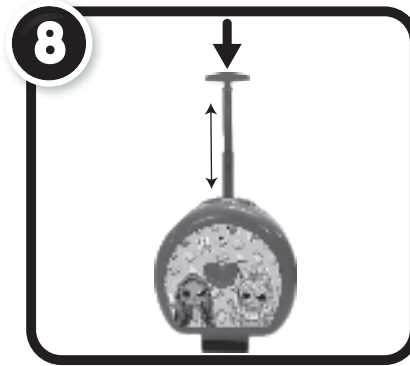

Close the travel closet and slide the zippers up. Press the button on top of the handle and pull up to extend the handle. To collapse the handle, press the button and push it down.



Take it on-the-go.

WARNING!

- The product is not intended to bear the mass/weight of a child. Do not sit or stand on the product.
- Not suitable for children under 3 due to size limitations.
- Avoid placing the product on an uneven surface or anywhere which might offer the possibility of tipping.
- Always check the condition of the product before allowing children to play.
- Store up to four fashion dolls and the accessories shown in this manual. Do not overload the product with objects not illustrated.

IMPORTANT INFORMATION

- Clean travel closet with a damp cloth.
- Fashion doll and accessories are not included. See contents for included items.
- Ensure the trays are locked in and the travel closet is zipped up before transporting.
- Keep hands and fingers clear of moving parts or when closing the travel closet.
- Do not leave contents in the sun or in very hot areas.

Please keep this manual as it contains important information.



0721-0-E/INT
Printed in China

www.LOLsurprise.com
©2021 MGA Entertainment, Inc.
L.O.L. SURPRISE!™ and L.O.L. SURPRISE! O.M.G. OUTRAGEOUS MILLENNIAL GIRLS™ are trademarks of MGA in the U.S. and other countries. All logos, names, characters, likenesses, images, slogans, and packaging appearance are the property of MGA.

MGA Entertainment, Inc.
9220 Winnetka Ave. Chatsworth, CA 91311 U.S.A.
(800) 222-4685

MGA Entertainment UK Ltd.
50 Presley Way, Crownhill, Milton Keynes,
MK8 0ES, Bucks, UK
+ 0800 521 558

MGA Entertainment (Netherlands) B.V.
Baronie 68-70, 2404 XG Alphen a/d Rijn, The Netherlands
Tel: +31 (0) 172 758038

Imported by MGA Entertainment Australia Pty Ltd
Suite 2.02, 32 Delhi Road
Macquarie Park NSW 2113
1300 059 676

The preferred method of contact for Customer Service is through our e-mail contact form at www.mgae.com

CLOSET

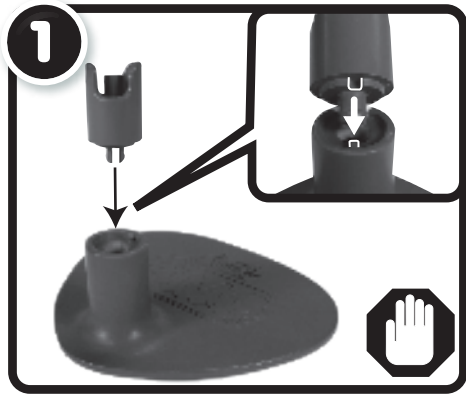

Assemble the travel closet stand by attaching the top piece to the base's stem. The top piece and stem are keyed. Align and snap in place. This is a one-time snap. Once attaching, it can't be removed.

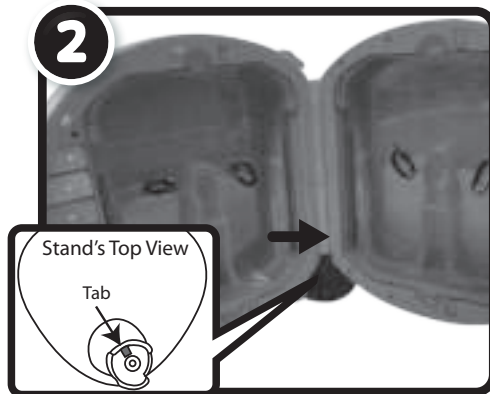

Place the stand on a flat surface. Slide the zippers down to open the travel closet and insert the hinge into the stand. When inserting the closet, make sure the recess on the hinge goes into the tab on the stand.

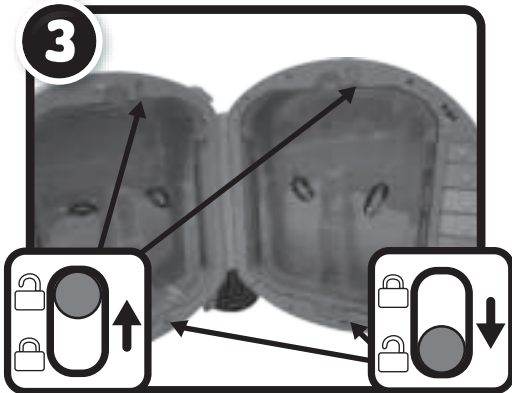

Unlock the trays by moving the switch above and below the trays from the locked position (🔒) to the unlocked position (🔓). Then, remove the trays.



Pull down the closet's rack. It will click in place. Then, add the hangers. Open the drawers to store accessories.



Pull out the stand on the back of the tray to stand it up.

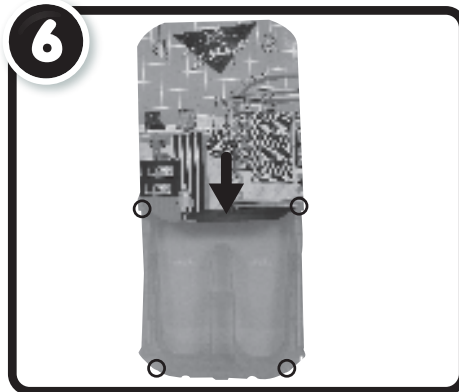

Add the backdrop to the trays by sliding it into the tabs on the tray from the top.

ON-THE-GO

Store up to four fashion dolls and accessories. Fashion doll, accessories and stand are not included.

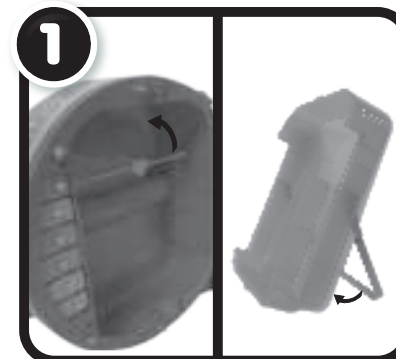

Lift the closet's rack. Then, pull out the backdrop and close the tray's stand.

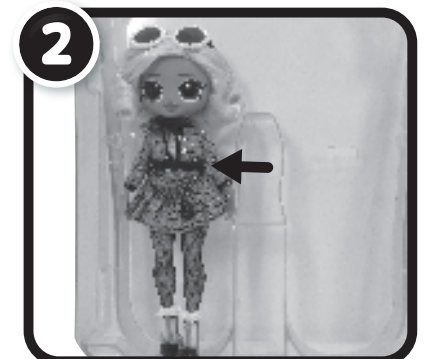

Carefully insert the doll into the elastic band.

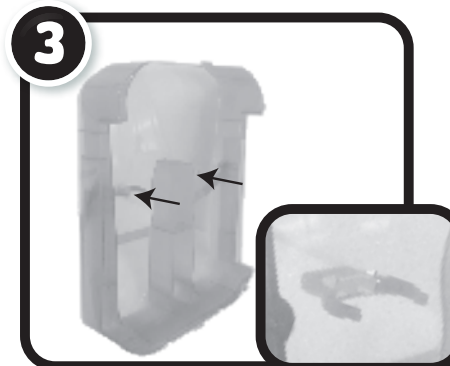

Carefully pull the doll to insert the C-Clip (not included) into the rectangular opening on the tray behind the doll.



Turn the tray over and slide the post into the back of the C-Clip. Clip the doll into the C-Clip. Repeat steps 2-4 to store other fashion dolls (not included).

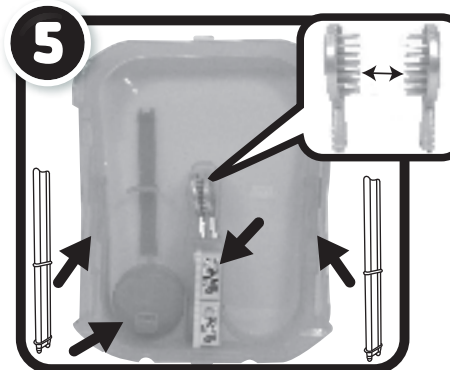

Place the base of the stand under the doll's feet. Store two brushes and two shoe boxes (or one long shoe box) in the compartments in the middle. Before storing the brushes, attach the bristles together. Store additional stand posts in the sides of the tray.

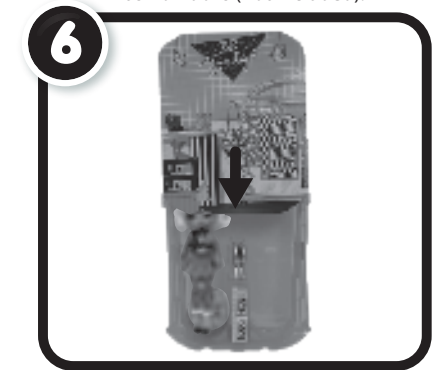

Slide the backdrop into the tabs on the tray.