

INVENIO

SMART DETECTOR & IMAGING SYSTEM

USER MANUAL

INVENIO
INVENIO PRO



Nakta | MAKRO
DETECTION TECHNOLOGIES

Authorized
R&D CENTER



DEVELOPMENT PROJECT
FUNDED BY THE SCIENTIFIC AND
TECHNOLOGICAL RESEARCH
COUNCIL OF TURKEY

READ CAREFULLY BEFORE OPERATION OF THE DEVICE

LEGAL DISCLAIMERS

► Comply with applicable laws and regulations governing use of metal detectors while using this detector. Do not use the detector without authorization in protected or archeological sites. Do not use this detector around unexploded ordnance or in restricted military zones without authorization. Notify appropriate authorities with details of any historical or culturally significant artifacts you find.

WARNINGS

- **INVENIO** is a state-of-the-art electronic device. Do not assemble or operate the device before reading the user manual.
- Do not store the device and search coil under extremely low or high temperatures for extended periods. (Storage Temperature: - 20°C to 60°C / - 4°F to 140°F)
- Do not immerse the device or its accessories (except for the search coil and the IPTU sensor) in water. Do not expose equipment to excessively humid environments.
- Protect the detector against impacts during normal use. For shipping, carefully place detector in original carton and secure with shock resistant packaging.
- **INVENIO** metal detector may only be disassembled and repaired by **Nokta & Makro Detectors** or its Authorized Service Centers. Unauthorized disassembly/intrusion into the metal detector control housing for any reason voids the warranty.

IMPORTANT

- Do not use the device indoors. The device may constantly give target signals indoors where there are many metals present. Use the device outdoors, in open fields.
- Do not let another detector or an electromagnetic device come in close proximity (10m (30ft.)) to the device.
- Do not carry any metal objects while using the device. Keep the device away from your shoes while walking. The device may detect the metals on you or inside your shoes as targets.



For Consumers within the European Union: Do not dispose of this equipment in general household waste. The crossed wheeled bin symbol on this equipment indicates this unit should not be disposed of in general household waste, but recycled in compliance with local government regulations and environmental requirements.



TABLE OF CONTENTS

PACKAGE CONTENTS	1
ASSEMBLY	2-3
INTRODUCTION TO THE DEVICE	4-5
IPTU SENSOR (Integrated Positional Tracking Unit)	6
BATTERY	7
CORRECT USE	8
INFO BAR	9
GROUND BALANCE	10-12
TARGET ID	12
OPTIONS	13-16
SETTINGS	17-21
PINPOINT	21
DETECTION SCREENS	22-23
SEARCH MODES	23-24
TURNING ON THE DEVICE AND DETECTION	25-27
RESULT SCREEN	28-29
ARTIFICIAL INTELLIGENCE AND NEURAL NETWORK	30
TECHNICAL SPECIFICATIONS	31

PACKAGE CONTENTS

INVENIO PACKAGE CONTENTS



- (1) System Box
- (2) Shaft & Handle
- (3) IPTU Sensor
- (4) INV40 Search Coil
- (5) INV28 Search Coil
- (6) System Box Carrying Case
- (7) Carrying Belt
- (8) Headphones
- (9) AC Charger
- (10) Car Charger
- (11) USB Cable
- (12) Protective Covers
- (13) IPTU Sensor Carrying Bag
- (14) Coil Mounting Hardware
- (15) Screen Sunshade
- (16) Waterproof (IP67) Hard Transport Case

INVENIO PRO PACKAGE CONTENTS



- (1) System Box
- (2) Shaft & Handle
- (3) IPTU Sensor
- (4) INV40 Search Coil
- (5) INV56 Search Coil
- (6) INV28 Search Coil
- (7) Headphones
- (8) System Box Carrying Case
- (9) Spare 9500 mAh Lipo Battery
- (10) AC Charger
- (11) Car Charger
- (12) USB Cable
- (13) Harness/Carrying Belt/Bungee Cord
- (14) Coil Mounting Hardware
- (15) IPTU Sensor Carrying Bag
- (16) Protective Covers
- (17) Screen Sunshade
- (18) INV56 Carrying Bag
- (19) Waterproof (IP67) Hard Transport Case

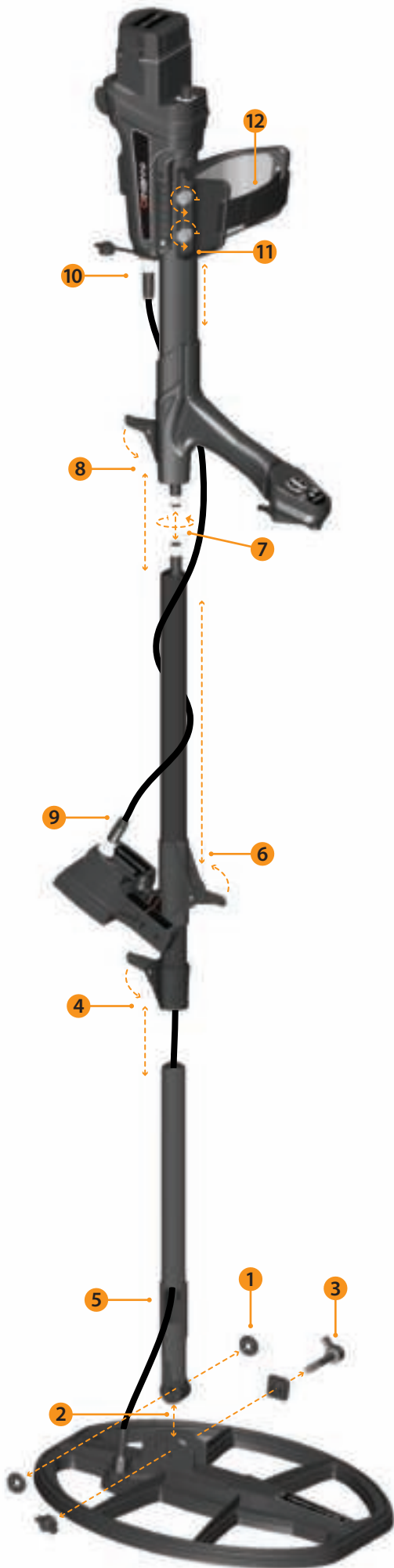

(1) Insert the washers on the lower shaft yoke.

(2) Insert the lower shaft yoke between search coil mount tabs.

(3) Attach the search coil to the lower shaft using the lever, winged nut and the washer without over-tightening.

(4) Fully insert the middle shaft into the lower shaft and push it until it contacts the stopper. Then, secure with the lever latch. If the lower shaft is not inserted fully, the connector at the end of the cable will not come out from the top of the shaft in the next step.

(5) Insert the search coil cable through the shaft as shown in the picture.

(6) Pull the lever latch of the IPTU sensor, attach it to the shaft in the direction shown in the picture and push it until the shaft's latch. Then, push the latch to secure.

(7) Join the two connectors of the system box cable and coil cable paying attention to the pins, then tighten. The system box cable is a retractable spiral and you can pull it in case you cannot join the two connectors easily.

(8) Join the middle and the upper shafts. Pull the excess cable out of the hole and push the lever latch on the upper shaft to secure. To adjust the shaft length, loosen the lever latch on the middle shaft, adjust the length to your height and press the latch to secure.

(9) Insert the connector of the IPTU connection cable into the socket on the sensor and secure by tightening the nut. While tightening, you will hear clicks. This is normal and indicates that the connector is locked in.

(10) Wind the sensor connection cable on the shaft without stretching too much. Then, plug the connector to the socket on the system box and secure by tightening the nut.

(11) To adjust the armrest, loosen the bolts. Slide the armrest up and down to adjust it to your arm and secure by tightening the bolts.

(12) Adjust the armrest strap to your comfort.

The assembly is now completed. You can start using the device after completion of the IPTU sensor assembly explained in the next section.

IPTU SENSOR ASSEMBLY

The angle of the sensor must be adjusted according to the type of coil attached to the device. In order to do this, the blue or the red line on the sticker located on the sensor must be aligned with the blue or red line on the sensor's lever latch. The red line is for INV28 and INV40 search coils and the blue line is for the INV56 search coil. Improper adjustment of the sensor angle will result in inaccurate operation of the sensor.

Details about the usage of the IPTU sensor and the things you must pay attention to are further explained in the manual. Please read those sections carefully!



ASSEMBLY

To wear the system box around your neck, assemble the carrying belt as shown in the pictures below.

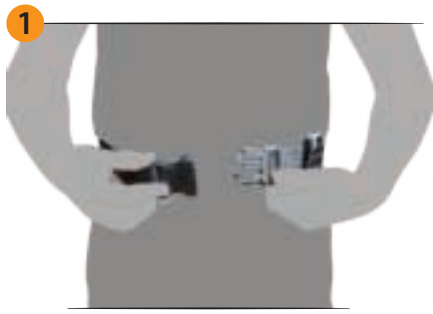

SYSTEM BOX CARRYING CASE ASSEMBLY AND DISASSEMBLY

To take the system box out of its carrying case, please follow the steps below. To put it back inside the case, reverse the process.



SYSTEM BOX

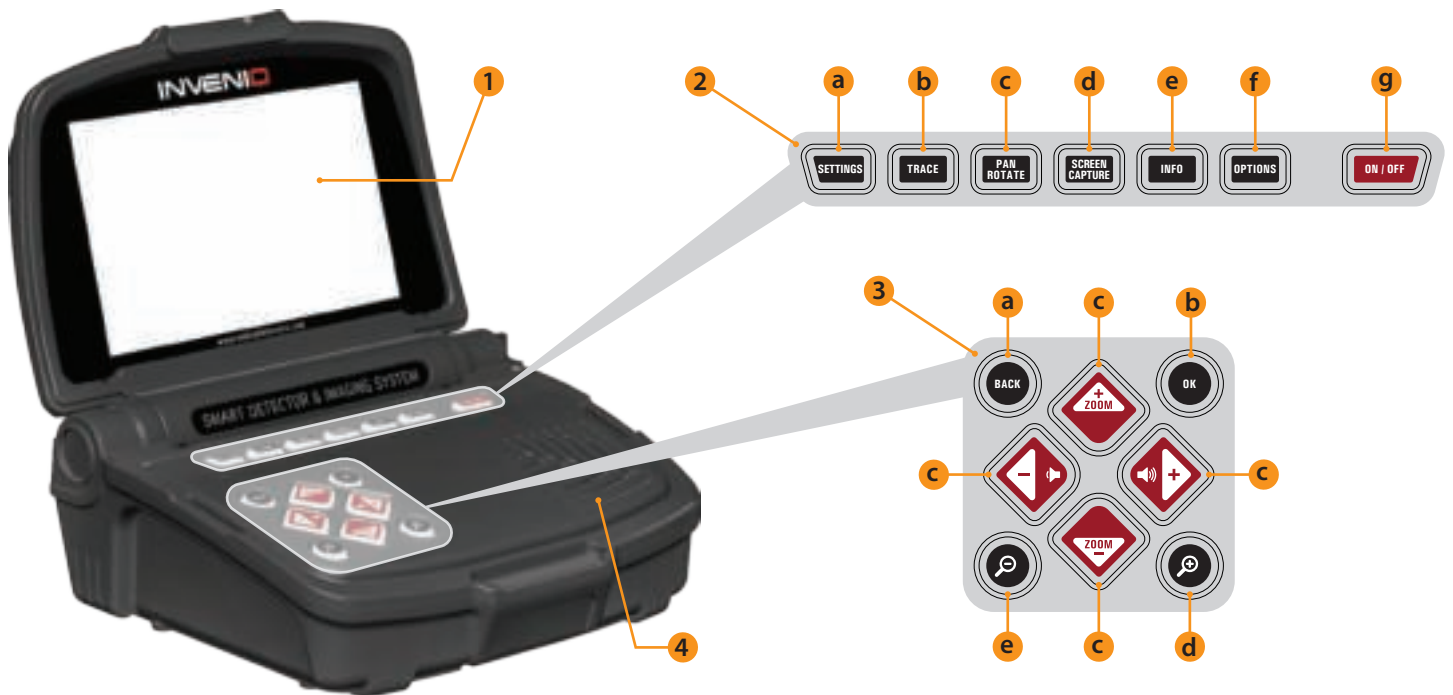

(1) LCD SCREEN

(2) UPPER KEYPAD – The functions of the buttons on this keypad are explained further in the relevant sections of the manual.

a) SETTINGS BUTTON : It is used to access the settings in the Detection, Scan and Result Screens.

b) TRACE BUTTON : It is used to follow the search coil in the detection screen with the IPTU sensor.

c) PAN/ROTATE BUTTON : It allows you to rotate and slide the 3D graph in the result screen.

d) SCREEN CAPTURE BUTTON : It takes a snapshot of the screen. It can be used in all menus and screens. Once you press this button, it takes the screen image, assigns a record number to it and then saves it in SCREENSHOTS under ARCHIVES by recording its date and time as well. When this button is pressed, a window with the following message will appear on screen : "Screenshot is successfully saved as...". To remove this window, press the OK or the BACK button.

e) INFO BUTTON : This button is used to open and close the information bar located at the bottom of the screen.

f) OPTIONS BUTTON : Allows you to access the general settings of the device.

g) ON/OFF BUTTON : It powers the system box on and off.

(3) LOWER KEYPAD – The functions of the buttons on this keypad are explained further in the relevant sections of the manual.

a) BACK BUTTON : It allows you to exit the current screen or to go back to the previous one. In addition, it is used to remove the pop-up message windows from screen.

b) OK BUTTON : This button is used to confirm an action or to go to the result screen after performing a scan.

c) DIRECTION/VOLUME/ZOOM BUTTONS : This set of keys has 3 different functions :

1- To navigate between the menu options and to adjust the settings.

2- To increase and decrease the volume with the plus (+) and minus (-) buttons in the detection screens as well as when the tutorial videos are being played.

3- The up and down zoom buttons are used to magnify or reduce the target signal graphs in detection screens. They are also used to fast forward or rewind the tutorial videos.

d) ZOOM IN BUTTON : Brings the detection and scan grounds closer on the screen. When fully zoomed in, the scale is 50cm.(20"). It is also used to zoom in to the 3D graph on the result screen.

e) ZOOM OUT BUTTON : Takes the detection and scan grounds further away on the screen. When fully zoomed out, the scale is 800 cm. x 800 cm (≈ 26ft. x 26ft.). It is also used to zoom out from the 3D graph on the result screen.



(4) SPEAKER

(5) SCREEN FIXING SCREW

(6) WIRED HEADPHONES SOCKET

(7) EXTERNAL USB MEMORY SOCKET

(8) BATTERY

(9) BATTERY LOCK

SHAFT AND HANDLE



(1) ON/OFF BUTTON : It powers the shaft and handle on and off. It works independently from the system box.

(2) BATTERY COMPARTMENT COVER

(3) IPTU SENSOR INPUT SOCKET

(4) GROUND BALANCE/PINPOINT AND RETUNE TRIGGER

This trigger has 3 functions :

1) It is used for automatic ground balancing. When you push the trigger forward, the ground balance screen is displayed.

2) In non-motion modes, it is used to retune the device. In order to do this, you need to pull the trigger once towards you and release.

3) In motion modes, it is used for pinpointing. You need to pull the trigger towards you and hold it for this function.

(5) LED FLASHLIGHT : It is the headlight used for lighting the area you are scanning while detecting at night or in dark locations. To activate the LED flashlight, double click the CLR button on the handle. It does not operate when the shaft & handle is off. It is recommended to turn it on only when necessary since its operation consumes extra battery power.

(6) SHAFT & HANDLE KEYPAD

a) BACK BUTTON : It has the same function as the BACK button on the system box. It allows you to exit the current screen or to go back to the previous one. In addition, it is used to remove the pop-up message windows from screen.

b) CLR BUTTON : In detection and scan screens, press and hold this button to clean the screen and to center the search coil (bring it to the origin) on the screen. It also turns on the LED flashlight when you double click it.

c) SCAN BUTTON : It is used to switch to the scan screen and to scan over detected targets. Please read the section "scanning" for more details.

d) WiFi LED INDICATOR : Indicates the wireless connection between the system box and the shaft & handle. If the LED is lit red, it means there is no connection. If it is lit green, it means they are connected.

e) OK BUTTON : It is used to confirm an action or to go to the result screen after performing a scan.

IPTU SENSOR (Integrated Positional Tracking Unit)



The IPTU unit, with the help of the integrated sensors, computes the right-left, forward-back movements of the search coil precisely and determines its location and height above the ground.

With the IPTU sensor, you can follow the start and finish points of the scanned area and view the locations of detected targets. In addition, you can determine the width and the length of the scanned area, the target depth and shape as well as the dimensions with the help of the IPTU sensor.

USAGE OF THE IPTU SENSOR

Correct usage of the IPTU sensor is critical in terms of the device's performance. The sensor must be used correctly in order for the device to accurately process the shapes, depth and dimensions of targets and display them on screen.

At initial start up, the IPTU sensor will be on by factory default. Based on the type of coil attached to the device, the location and angle of the sensor must be adjusted. It must also be parallel to the ground.

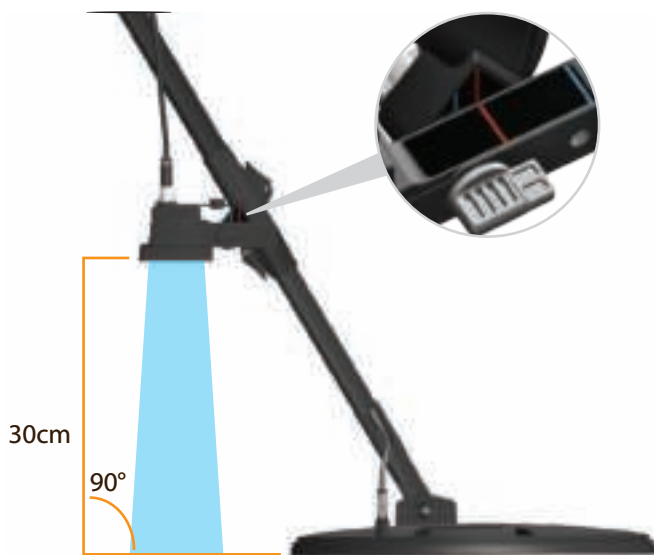

To determine whether the IPTU sensor is working properly or not, you need to observe the coil movements on the screen. As you move the search coil, the coil on the screen should move in the same direction as well. If you cannot see the actual movements of the search coil on screen, there may be 3 reasons for this :

- 1) The sensor may not have been calibrated at all or may have been calibrated inaccurately.
- 2) If the ground consists of a single color and has no texture to it (such as land covered with snow) the sensor may not work properly.
- 3) In cases where the shadow of the sensor falls in front of the search coil, the sensor may not work properly.

THINGS TO PAY ATTENTION TO WHILE USING THE IPTU SENSOR :

1) First, adjust the shaft length and coil angle to searching position. Then place the search coil on a flat surface, adjust the search coil angle so that it is parallel with the ground and lean it against a fixed object such as a tree, rock or a wall. If there is no place to lean it against, hold it stable with your hand.

2) You must calibrate the sensor before each use or if you have changed its angle. The calibration process must be performed on a flat surface. You can find more details on calibration in the further sections of the manual.

3) The location and the angle of the sensor must be adjusted properly according to the coil being used.

NOTE : When the INV56 search coil is attached to the device, the message "Attach the sensor to the 2nd hole!" will appear on screen. When mounting the INV56 coil to the shaft, if you have left the sensor angle at the red line and not aligned it to the blue line, the sensor's field of view will be restricted by the search coil as shown in the picture. In such a case, unscrew the sensor and re-attach it so that the blue lines are aligned as shown in the image. Then you can press the OK button to clear the message. If you remove the INV56 coil and attach the INV28 or INV40 coil, this time the message "Attach the sensor to the 1st hole!" will appear.



4) The sensor's lens must be clean. Any dust, mud etc. on lens will restrain the device from obtaining accurate data.

5) The height of the sensor above the ground must be minimum 25cm. (10") - maximum 80cm. (31.5"). The recommended height is between 30cm.- 50cm. (≈12"-20").

6) Pay attention to keeping your feet away from the sensor's field of view.

7) The sensor may not work accurately on snow.

8) Using the sensor on flat, smooth surfaces (such as tiles or wood floor) in places such a home or an office may yield wrong results.

9) Once the sensor is calibrated, changing the angle of the sensor or the search coil will result in obtaining inaccurate data.

10) During sunny days, if the shadow of the sensor falls in front of the coil, the sensor will not work. In such a case, you may try extending the shaft length. If the sensor is still not working, you need to change your direction to avoid the sunlight.



11) The sensor may not obtain accurate data if the shaft & handle battery is low.

BATTERY

INVENIO works with 2 lithium polymer batteries. One of these is located inside the system box (5500mAh) and the other one is at the back of the shaft (5400mAh).

In addition, the INVENIO Pro includes a spare 9500mAh battery providing a longer battery life for the system box.

Battery Life :

5500 mAh system box battery : Approximately 5 hours

5400 mAh shaft & handle battery : Approximately 9 hours

9500 mAh system box spare battery : Approximately 9 hours

LED flashlight, brightness, usage of speaker or wired/wireless headphones etc. are factors affecting battery life.

In INVENIO Pro, battery life will vary based on operating frequency. Battery life will be less in 5kHz compared to other frequencies.

Charging

Charge both the INVENIO system box and shaft & handle before initial use. Charging will take approximately 2 hours for each battery. The spare battery that comes in the INVENIO Pro will take about 4 hours to charge.

You can charge the batteries while they are installed in the device or take them out and charge them.

NOTE : If you charge the system box battery on the device, the battery icon will always show as charging. Even if the battery is full, the icon will not show full battery. The icon will display battery full status after you remove the charger.

To remove the system box battery, push the battery lock shown in the picture upwards. The battery will pop out a little bit. Then, pull it to remove.



To remove the shaft & handle battery, push the tabs on each side of the battery cover and remove the cover.



After removing the battery, plug the charger into the charging socket on the battery. After charging is completed, insert the battery back in the compartment and close the cover. Be sure that the tabs sit securely in place.



NOTE : When inserting the battery, pay attention to the direction of the sockets.

During charging, the LED on the battery will light up red. When the battery is full, it will turn green.

NOTE : The LED on the charger does not indicate the charging status, it lights up green at all times.

NOTE : If you charge the battery while the device is on, you will see a charging sign inside the battery icons on the INFO bar.

IMPORTANT! Do not use a different charging adapter other than the one supplied with your device!

Low Battery

There are 2 battery icons, numbered as 1 and 2, on the INFO bar at the bottom of the screen. Battery 1 indicates the battery life status of the system box and battery 2 indicates the battery life status of the shaft & handle. When the batteries are full, the icons will be green and when the batteries are low, they will turn red and the low battery warning will appear on screen.

BATTERY WARNINGS :

Do not expose the device to extreme temperatures (for example a car's trunk or glove compartment)

Do not charge the battery in temperatures over 35° C (95° F) or below 0° C (32° F).

CORRECT USE



It is very important to adjust the shaft to your height correctly to be able to search without discomfort and fatigue.



Adjust the height of the shaft so that you are standing in an upright position, your arm is relaxed and the search coil is approximately 5cm (~2") above the ground.

CORRECT WAY OF SWEEPING

Wrong search coil angle



Wrong search coil angle



Correct search coil angle



Incorrect way of sweeping

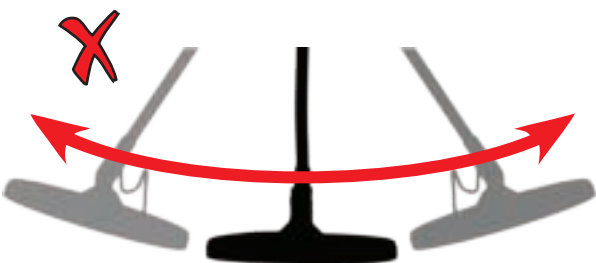

Correct way of sweeping

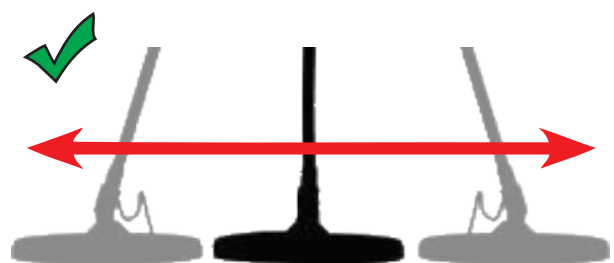

It is important to keep the search coil parallel to the ground in order to get accurate results.

The search coil must be parallel to the ground at all times.



This is the information bar located at the bottom of the screen. To see the info bar, just press the INFO button. It hides automatically or by pressing the INFO button again. If there is a warning in the message section, the INFO bar will reappear after a certain period of time.

We can view the INFO bar in 3 sections as below :

Left Side

It shows which command buttons can be used on each screen or menu (Back/OK/Directional Buttons/CLR/Scan). Active ones will appear green, inactive ones will appear red.

Middle Section

Shows the mode, operating frequency and warning messages.

Messages that may appear are as follows :

Overload

It appears on screen simultaneously with the overload alarm. This happens when the search coil encounters a near surface or a very large object. The device reverts back to normal operation if you lift the coil up. If the alarm and the message continue along a long line, you may be over a long metal such as a pipe.

In case of high mineralization, the device may overload. If the cause of overloading is not a large metal, it may be the ground itself and this situation may be overcome by lowering the sensitivity.

Coil is disconnected!

It indicates an interruption in the search coil transmitter signal. The search coil connector may be unattached, loose or disconnected. If you own another detector with the same coil connector, please be sure that you have not attached the wrong coil by mistake. If none of the above exists, the search coil or its cable may have a defect. If the issue continues when you change the search coil, there may be an issue in the coil control circuit.

WiFi is off

It will come on screen when there is no wireless connection between the system box and shaft & handle. In such a case, first check whether the shaft & handle is on or not. If it is on, try changing the WiFi channel. For this, press the OPTIONS button, select "Wireless Shaft Channel" and search the channels.

Shaft is not connected!

It comes up on screen when the Wireless Shaft Channel is switched to off position.

Refresh GB!

This message will appear under the following situations: When the operating frequency is changed (only in INVENIO Pro), when the sensitivity level is changed or when the mode settings are restored to factory defaults. It indicates that you should re-ground balance the device. Once you ground balance, the message disappears.

Calibrate the sensor!

It comes up on screen at initial start up or when you switch to the detection screen with the IPTU sensor. For the calibration process, press the SETTINGS button and select "Calibrate the sensor". For more details, please read the relevant sections of the manual.

Pump the coil!

This message appears when the trigger is pushed forward for automatic ground balancing. It does not indicate any error or problem. It only indicates what should be done.

Right Side

This section shows the status of some of the hardware features of the device.



Indicates the status of the wireless connection between the system box and shaft & handle. Green means connected, red means disconnected.



If the optional wireless headphones are connected, the headphone icon will appear. Otherwise, the speaker icon will show. If the volume is turned off, the icons will turn from green to red.



Indicates whether the vibration is on or off. If it is green, vibration is on. If it is red, vibration is off.



In the SETTINGS or ARCHIVES screen, it indicates the detection of an external USB drive.



Battery icon number 1 shows the battery life status of the system box and battery icon number 2 shows the battery life status of the shaft & handle (only when the shaft & handle is on).

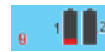

When the system box battery is dead, the countdown numbers before the system shuts down, are shown here.

GROUND BALANCE

Ground balance can be performed in three ways with the INVENIO: Automatic, Manual and Tracking.

The ground balance screen is a separate window in detection screens (except for the Ground Anomaly & Cavity mode). In the detection screen with the IPTU sensor, you can remove the ground balance screen by pressing the INFO button but it is fixed in the detection screen without the IPTU sensor. The ground balance window is divided into 2 parts: The top part shows the instant ground balance value changes while searching and the bottom part shows the adjusted ground balance value.

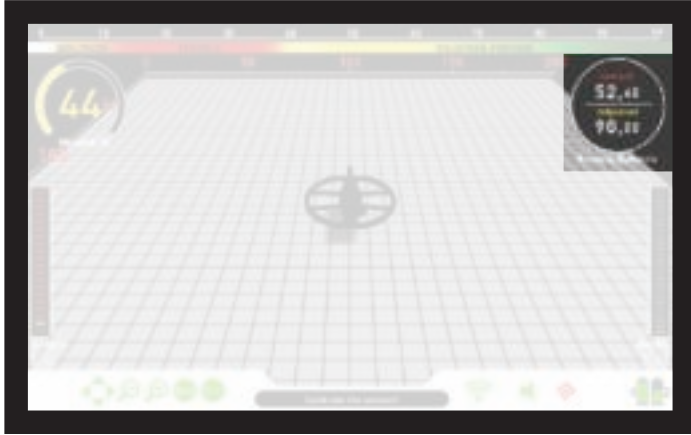

If the trigger is pushed forward while performing an automatic or manual ground balance, the device will switch to All Metal mode automatically on the background without any indication to the user, regardless of the selected search mode.

Upon completion of ground balance, the ground balance value is shown under "Adjusted" in the ground balance window.

Automatic Ground Balance

Automatic ground balance is performed as follows in all search modes:

- 1) First, find a spot of ground where there is no metal present.
- 2) Push the ground balance trigger forward and hold it. The ground balance screen will be displayed automatically and the word "Automatic" will appear bigger on screen.



3) Hold the search coil parallel to the ground. Continue to push and hold the trigger forward and start pumping the search coil up and down from about 20 cms. (~8") above the ground down to 5 cms. (~2") off the ground with smooth movements and keeping it parallel to the ground (this is also shown by animation on the screen).

4) Continue until a beep, indicating the completion of ground balance, is heard. Based on ground conditions, it usually takes about 2-4 pumps for the ground balance to be completed.

5) When the ground balance trigger is released, the device continues to operate in the All Metal mode for a short period of time and the ground balance window stays on screen. The word "Manual" will appear bigger on screen. This makes it possible to manually fine tune the automatic ground balance value. Refer to the following "Manual Ground Balance" section for further information regarding this feature. If no button is pressed for a while, the device will revert back to the detection screen automatically. If you do not want to wait for the timeout period, you can switch to the detection screen by pulling and releasing the trigger once.

6) Upon completion of the automatic ground balance, ground balance value will be shown under "Adjusted" in the ground balance window and it will be same as the "Instant" value. The device continues to ground balance and produce a beep sound as long as you keep the trigger pushed forward and pump the coil. In order to ensure that the ground balance is proper, ground balance at least 2-3 times and check the ground balance values on screen. In general, the difference between the values shall not be higher than 1-2 numbers.

7) If you cannot ground balance, in other words, if no beep sound is produced, it means that either the ground is too conductive or not mineralized or there is a target right below the search coil. In such a case, retry ground balancing at a different spot. If you still cannot ground balance, read the section titled "Important Details Concerning Ground Balance".

NOTE : If the Stabilizer value is set high, the device may not auto ground balance. In such a case, go to the SETTINGS of the All Metal mode and select Stabilizer. Lower the Stabilizer value first. After ground balancing, set the Stabilizer value back to its original level.

Manual Ground Balance

Allows you to manually modify the ground balance value. It is not preferred mostly because it takes time. However, it is the preferred option in cases where a successful ground balance cannot be performed using other methods or minor corrections are required for the automatic ground balance.

INVENIO is designed to allow for automatic ground balancing conveniently on any type of ground. Therefore, it is recommended to perform automatic ground balance upon start up. However, the ground may not be suitable for automatic ground balancing in some cases and the device cannot ground balance on such grounds. For instance, wet beach sand, soils containing alkali or salty water, trashy sites, ploughed fields, highly mineralized grounds and grounds with very low mineralization are not suitable for automatic ground balance. In such terrains, you can perform manual ground balancing. However, manual ground balance requires a skill which develops over time through practice.

To perform manual ground balance :

- 1) First, find a spot of ground where there is no metal present and switch the device to All Metal mode.
- 2) You need to listen to the sounds coming from the ground in order to perform manual ground balance. Pump the search coil up and down from about 20 cms. (~ 8") above the ground down to 5 cms. (~2") off the ground with smooth movements and keeping it parallel to the ground.

If the sound gets higher when lifting off the search coil above the ground, the ground balance value is too low, in other words, the effect from the ground is negative and the ground balance value needs to be increased by using the plus (+) button. On the other hand, if the sound gets higher when lowering the search coil to the ground, the ground balance value is too high, in other words, the effect from the ground is positive and the ground balance value needs to be decreased by using the minus (-) button.

GROUND BALANCE

3) Push the ground balance trigger forward once and release it. The ground balance screen will open up and stay on screen for a while. You can return to the ground balance screen by pushing the ground balance trigger forward if the screen switches.

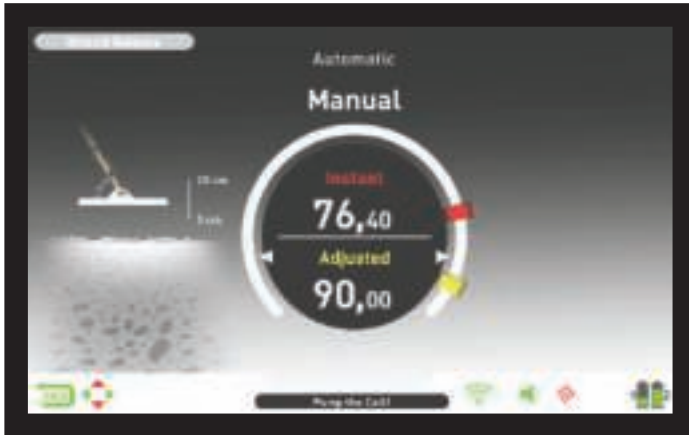

Manual ground balance functions within the range of 0,00 -99,80. However, each value covers 5 steps used for fine tuning within itself and these steps are indicated as multiples of 20.

Press plus (+) or minus (-) button to increase or decrease the ground balance value, respectively. If the button is pressed once at a time, the values count one by one and if it is held down, the values will change quickly.

4) Repeat the above procedure until the sound heard from the ground is eliminated.

The sound may not be eliminated completely in some areas. In these cases, listen to the sounds produced when moving the search coil towards and away from the ground to check if the ground balance is correct. If there is no difference between the two sounds then the ground balance is set properly.

The device will return to the detection screen automatically after a short period of time upon completion of ground balance. If you do not wish to wait for the timeout period, just pull and release the trigger once to go to the detection screen instantly.

IMPORTANT! Experienced detectorists adjust the ground balance setting to a slightly positive response (weak but audible sound is produced when moving the search coil closer to ground). This method may produce favorable results for experienced users in certain fields where small targets are searched for.

Tracking

This feature is present in the Motion modes only and not available in the Non-motion modes.



In this option, the user does not need to make any adjustments. Tracking feature is activated by selecting it from the settings of the motion modes and by switching it to on position. The word "Tracking" will be displayed in green at the bottom of the ground balance window. The device updates the ground balance automatically as long as the search coil is swung over the ground and shows the ground balance value in the ground balance window. It does not provide any feedback to the user (like the beep sound in automatic ground balance).

While tracking is active, the device can initially produce a loud signal when it detects a different ground structure (for instance a mineral rock) or a target. In this case, swing the search coil over the spot where the device produces the signal. If the sound remains the same and the device shows an ID, it is possibly a target. If the sound attenuates too much or is lost after a few swings, it means that the device has produced a signal for the different ground structure or a stone.

NOTE : It is recommended that you use tracking in the All Metal mode and not in the discrimination modes.

NOTE : Tracking is not a mode specific setting, when it is turned on it will be active in other motion modes as well. If you switch to one of the non-motion modes while tracking is on, it will be turned off and once you switch back to a motion mode, it will be active again automatically.

Tracking is suitable for use in areas where different soil structures are present within the same land or in fields where mineralized rocks are scattered widely apart. If you use ground tracking in areas where hot rocks are intensely present, the device may not be able to eliminate these highly mineralized rocks or you may miss the smaller or deeper metals.

IMPORTANT! Ensure that tracking is off during air tests. Otherwise, the device will attempt to perform ground balance on the target and the depth will be reduced.

Ground Balance Value

Ground balance value provides information about the ground you are searching on. Some typical ground types are as follows :

0-25	Wet salt water or wet alkali soils
25-50	Wet salt water and wet alkali soils covered with dry layers
50-70	Regular, low-quality soils
70-90	Highly magnetic soils, magnetite or maghemite and similar highly mineralized soils, black sand.

Important Details Concerning Ground Balance

1) Upon start up, the ground balance value is set to 90. The device can perform ground balance automatically within the following ranges for each type of search coil :

INV28 search coil	: 40,00 - 99,00
INV40 search coil	: 20,00 - 99,00
INV56 search coil	: 0,00 - 99,00

2) If the ground mineralization is too low, automatic ground balance may fail. In such a case, you can try manual ground balancing.

3) You can test the accuracy of the ground balance with pinpointing in motion modes. After ground balancing, if you receive no sound or a weak one when you move the search coil closer to the ground in the pinpoint mode, then the ground balance is successful. If the sound gets louder when you move the search coil closer to the ground, then the ground balance is not successful. In this case, simply change your location. If ground balance is not possible despite these efforts, you should continue your search without performing ground balance.

GROUND BALANCE

You cannot search in the All Metal and Non-Motion modes (except for the Ground Anomaly & Cavity) without ground balancing. You need to use one of the discrimination modes and increase the Discrimination value until the noise is eliminated.

4) Once the ground balance is set, it will remain satisfactory for a long time in most areas. However, if you encounter an excavated, backfilled or geologically composite soil structure, ground balancing should be performed again to adapt to the varying soil structure. In addition, re-ground balancing is recommended if you change the operating frequency of the INVENIO Pro (5kHz / 14kHz / 20kHz) in certain ground conditions.

5) When using the optional large coil, pump the coil more slowly and do not keep it very close to the ground.

6) In some cases where the Stabilizer value is set high, the device may not be able to ground balance automatically. In such a case, first lower the Stabilizer value and after ground balancing switch it back to its previous level.

7) If the vibration feature is enabled, even if you are using one of the non-motion modes where this feature is not active, the device would vibrate during ground balancing because it switches to All Metal mode to perform the ground balance.

TARGET ID

TARGET ID is the number produced by the metal detector based on the conductivity of the metals and gives an idea to the user about what the target may be. Target ID is shown with two digits on the display and ranges between 00-99.

In some cases, the device may produce multiple IDs for the same target. In other words, the IDs may be jumpy. This may result from several factors. Target orientation, depth, purity of the metal, corrosion, mineralization level of the soil etc. Even the direction of the search coil swing may cause the device to generate multiple IDs.

In some cases, the device may fail to provide any ID. The device needs to receive a strong and a clear signal from the target in order to provide an ID. Therefore, it may not be able to provide an ID for targets at fringe depths or smaller targets even if the device detects them.

Keep in mind that target IDs are "probable", in other words, estimated values and it would not be possible to know the properties of a buried object exactly until it is dug out.

IDs of non-ferrous metals such as copper, silver, aluminum and lead are high. Target ID range of gold is wide and may fall within the same range of metal wastes such as iron, foil, screw caps, and pull tabs. Therefore, if you are looking for gold targets, digging out some trash metals is expected.

NOTE : Keep in mind, large targets will ID higher than expected, even though they may be of lower conductance.

IMPORTANT! INVENIO Pro uses a normalized ID scale. In other words, the IDs will not change upon frequency change and the device will generate the 14kHz IDs in each frequency. However, based on ground conditions IDs may vary for certain metals.



You can navigate between the OPTIONS with the up and down buttons. You can change the value using the plus (+) and minus (-) buttons. If the up/down and +/- buttons are held down, the options and values will change rapidly. Options are shown in white. When selected, they will turn orange. The corresponding values of an option are shown in white, the selected one will turn red and once adjusted, it will be shown in yellow.

NOTE : Regardless of the screen you are in, when the OPTIONS button is pressed, the device will display the OPTIONS screen. You can go back to the previous screen by pressing the BACK button.

FREQUENCY

It is used to change the operating frequency of the device. INVENIO works at 14kHz only. Therefore, this option is not selectable in INVENIO and it is active in INVENIO Pro only.

After selecting the FREQUENCY option, change the frequency using the plus (+) and minus (-) buttons. You will hear the sound of the relay circuit in the shaft; this is normal.

INVENIO offers 3 operating frequencies – 5kHz, 14kHz and 20kHz– to suit different target and soil types. Based on the frequency selected, the detector's detection performance for different types of targets will vary. The list below includes, but are not limited to, different types of targets that correspond to each frequency :

5kHz : Large ferrous and non-ferrous objects – High conductives (silver, copper etc.) – Medium or relatively small targets in non-mineralized ground without iron trash – Ferrous masses and militaria.

14kHz : General use – Different size targets in medium-highly mineralized ground.

20kHz : Small coins and large objects with different conductivities as well as thin large coins – Gold coins, rings, small jewelry, sheet iron, foil – Small targets in iron trash.

IMPORTANT! Please remember to re-ground balance upon changing the frequency.

FREQUENCY SHIFT

It allows you to shift the frequency in small steps. It is used to eliminate the electromagnetic interference that the device receives from another detector which operates in the same frequency range nearby or from the surroundings. If too much noise is received when the search coil is lifted in the air, this may be caused by the local electromagnetic signals or excessive sensitivity settings.

To eliminate the noise caused by electromagnetic interference, try shifting the frequency first before lowering the sensitivity to obtain maximum depth performance. Frequency shift consists of 5 steps (-2 / -1 / 0 / +1 / +2). Default setting is 0 which is the central frequency.

IMPORTANT! Frequency shift may impair performance. Therefore, it is suggested that you do not shift the frequency unless it is necessary. In cases where the interference cannot be eliminated with the frequency shift, in the INVENIO Pro, the operating frequency of the device (5kHz / 14kHz / 20kHz) may also be changed.

IPTU SENSOR

Allows you to turn on and off the IPTU sensor and switch between 2 detection screens – one with and one without the sensor. The device will start in detection screen with the IPTU sensor at initial start up. If you wish, you can turn the IPTU sensor off by using this option and switch to the detection screen without the IPTU sensor.

WIRELESS HEADPHONE CHANNEL

It is used to change the channel of the optional wireless headphones. It consists of 5 channels and an off position. When it is at off, there will be no wireless connection available for the headphones.

You scan the channels manually or automatically. To scan manually, use the plus (+) and minus (-) buttons when the option is selected. Each time you press the + or the - button, you need to wait approximately 1 second. If you want to scan the channels automatically, press the OK button when the option is selected. Channels will be scanned one by one and an automatic connection will be attempted. If you wish, you can cancel the auto scan by pressing the OK button. If no connection is made after each channel is auto scanned, the scanning will be terminated.

WIRELESS SHAFT CHANNEL

It is used to change the wireless connection channel of the shaft & handle. It consists of 32 channels and an off position. When it is at off, there will be no wireless connection available between the system box and the shaft & handle. To scan the channels manually, you can use the plus (+) and minus (-) buttons. Each time you press the + or the - button, you need to wait approximately 1 second. If you want to scan the channels automatically, press the OK button when the option is selected. Channels will be scanned one by one and an automatic connection will be attempted. If you wish, you can cancel the auto scan by pressing the OK button. If no connection is made after each channel is auto scanned, the scanning will be terminated.

VOLUME

This control allows you to increase or decrease the device's volume based on your preference and environmental conditions. Volume level can be adjusted from 0 to 10 using the plus (+) and minus (-) buttons. When the volume is turned off completely, the volume icon on the INFO bar will turn red. When you turn the volume up, it will turn green. In addition, while the device is in detection screen, volume can be adjusted with the plus (+) and minus (-) buttons directly, without going into OPTIONS. When you turn off and on the device, it will start with the last volume level you chose. Because the volume level affects power consumption, we recommend you not to increase it more than necessary.

VIBRATION

This option is used to adjust the vibration level.

This feature provides feedback to the user by producing a vibration effect when a target is detected. It can be used independently or together with the audio response. When audio response is disabled, all feedbacks are provided to the user as vibration only during target detection.

Vibration has 5 levels and it is adjusted with the plus (+) and minus (-) buttons. When it is set to 0, vibration feature is completely disabled. If the vibration is set to the 1st level, the device provides long vibration signals and at 5 it provides short vibration signals. The magnitude of the vibration effect can vary according to the depth of the target and the swinging speed. Vibration works in motion modes only. It works

in the static modes only in case of overload. When vibration is active, the vibration icon on the INFO bar will turn green, when vibration is disabled, it will turn red.

Vibration may not be felt in the All Metal mode with weak signals; it will be felt as the signal gets stronger. In other words, vibration does not start at the depth where the audio tones are heard but at a lesser depth. Therefore, if you are detecting with vibration only and audio tones are off, you can miss weaker and deeper signals.

Vibration speed is constant in the pinpoint mode and cannot be adjusted. Vibration is off at 0 position. 1-5 values provide the same level of vibration in the pinpoint mode. When vibration is used in the pinpoint mode, vibration speed increases as the target is approached and it reaches the maximum level over the center of the target. When you turn off and on the device, it will start with the last vibration level you chose.

KEYPRESS VOLUME

It is used to adjust the volume of the keypress sounds according to your personal preference by using the plus (+) and minus (-) buttons. It has 5 levels. As the level goes up, the volume goes up and vice versa. At 0 level, the volume will be off and no sound will be heard when the keys are pressed.

BRIGHTNESS

It enables you to adjust the screen backlight level according to your personal preference. It ranges between 0-10 and it is adjusted by the plus (+) and minus (-) buttons. At 0 level, the backlight is off. At 10, brightness will be maximum. The maximum levels of the of the backlight will affect power consumption, so we recommend to set it to lower levels.

KEYPAD BACKLIGHT

It enables you to adjust the backlight of the system box and handle keypads. It has 7 levels and it is adjusted by the plus (+) and minus (-) buttons. At 0 level, the keypad backlight is off. At 7, keypad brightness will be maximum. The maximum levels of the of the keypad backlight will affect power consumption, so we recommend to set it to lower levels.

LANGUAGE

It is used to change the operating language of the device. INVENIO can be used in 17 different languages. The device will start up in the default language set by the factory. You can change the language by selecting this option and using the plus (+) and minus (-) buttons. Once you select the language, just press OK and the device will switch to that language automatically. When you turn off and on the device, it will start with the last language you chose.

TIME/DATE

It is used to adjust the time and date. By using the plus (+) and minus (-) buttons, select the option (hour, minute, day etc.) you want to adjust. The selection will be marked in red. Adjust it using the up and down buttons. Once the adjustment is done, press the OK button to save. Once the time and date are set, you can only change them manually again. In other words, even if you set the device to factory defaults, the time and date will stay the same.

NOTE : If the time and date change each time you turn off and on the device, the clock battery may be dying. Please get in touch with your dealer or technical service.

CM/INCH

It is used to change all the units of lengths (depth, height, width etc.) from centimeters to inches. It is adjusted with the plus (+) and minus (-) buttons. The selected unit will be marked in red.

OTHERS

SOFTWARE UPDATE

This option shows the software version installed on your device and it also enables you to update your device. All software updates for the INVENIO will be published on the product page at www.noktadetectors.com. You can follow all updates and instructions from this page.

FACTORY SETTINGS

It is used to set all the options and settings of the device back to its factory defaults.

When the factory defaults are restored, all settings except for the time, date and language will be changed.

To restore the factory settings, press the OK button when the option is selected. "The system will be restored to factory defaults. Are you sure you want to continue?" message will appear on screen. If you press OK, you will see the second message "Do you also want to delete all your saved files in the archives?". Once you respond with yes or no to this, the message "Do you want to reset the neural network to factory defaults?" will come on screen. After you respond with yes or no, you will see the message "Please wait..." and a progress bar. Once the progress bar is full, the device will be restored to factory defaults and will start in the Basic mode.

NOTE : If you answer yes to "Do you also want to delete all your saved files in the archives?" all 3D graphs and screenshots saved in archives will be deleted.

NOTE : If you answer yes to "Do you want to reset the neural network to factory defaults?" the device will delete all the changes made in the neural network.

ARCHIVES

This section of the device enables you to access all the 3D graphs meaning result screens, the screenshots and the tutorial videos. You can transfer all the files you saved in archives to an external USB drive as well.

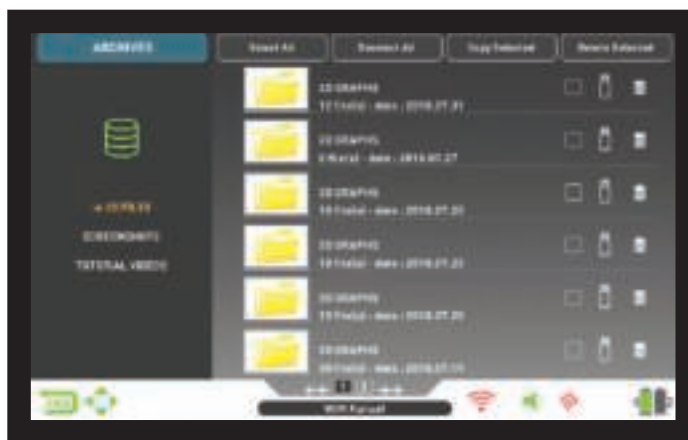

Select All

Selects all the folders or files.

Deselect All

Deselects all folders or files.

Copy Selected

Copies the selected folders or files to USB drive.

Delete Selected

Deletes the selected folders or files.

3D FILES

All the saved 3D graphs, in other words the result screens, are collected

OPTIONS

under this folder. Result screens are filed in chronological order. Graphs saved on the same date are numbered and filed in the same folder. Graphs saved on different dates are filed and listed according to the date they were saved on. In the folder view, next to the folder, you can see the date and number of records in the folder.

When 3D files are selected, to select a folder, press the plus (+) button. The selection box will move to the adjacent section. The selected folder will be displayed in orange. If multiple folders are saved, you can use the up and down buttons to navigate through them and access them by pressing the OK button. Once you are in the folder, you can select the record using the directional buttons and open it by pressing the OK button. When you want to exit, just press the BACK button.

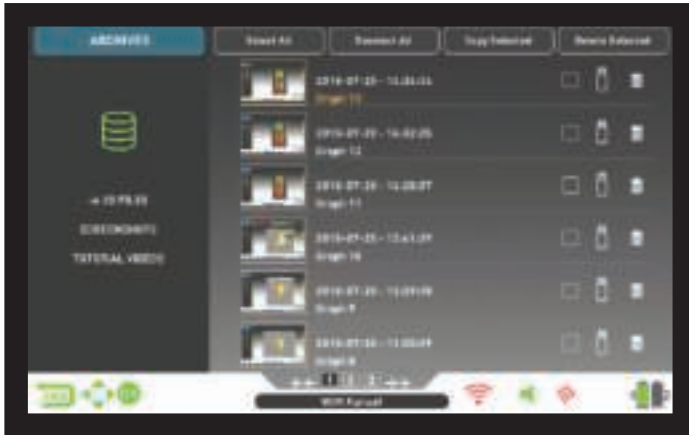

A total of 6 folders and 6 3D graphs in each folder will be displayed on one page. As the number of result screens and folders increase, the device will automatically add more pages. The page numbers will be displayed at the bottom of the screen. By pressing the down button, you can go to page selection and select the page you want by using the plus (+) and minus (-) buttons. Folders are displayed in chronological order from latest to oldest.

SCREENSHOTS

All screenshots taken are stored in this section.

When screenshots are selected, to select a folder, press the plus (+) button. The selection box will move to the adjacent section. The selected folder will be displayed in orange. If multiple folders are saved, you can use the up and down buttons to navigate through them and access them by pressing the OK button. Once you are in the folder, you can select the record using the directional buttons and open it by pressing the OK button. When you want to exit, just press the BACK button.

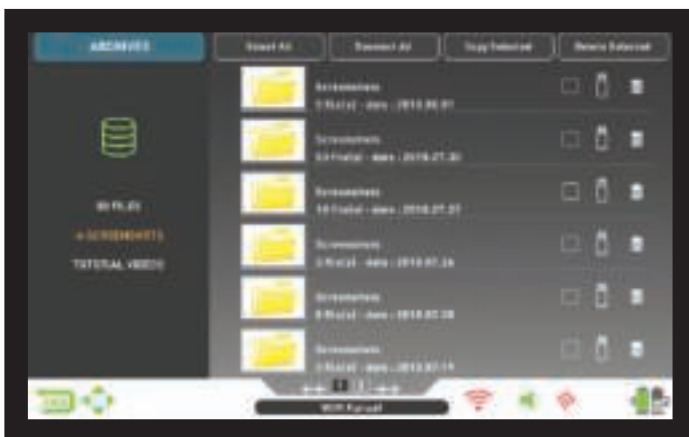

While an image is displayed on screen, if you press the SETTINGS button, DELETE message will appear at the top. If you press the OK button, you will see the message "Are you sure you want to delete the selected items?". Press OK to delete and go to the next record.

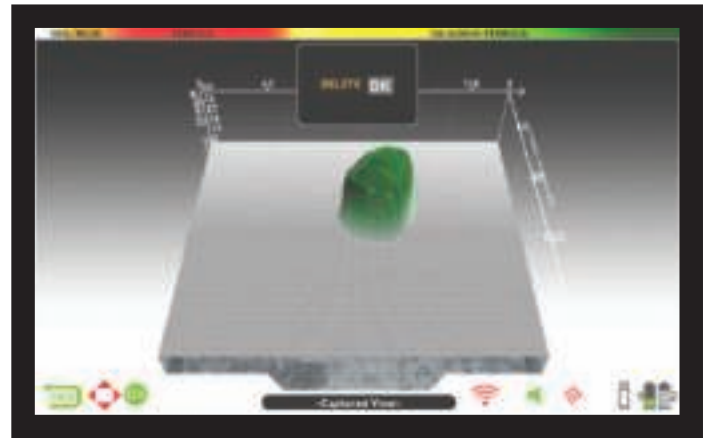

A total of 6 folders and 6 screenshots in each folder will be displayed on one page. As the number of screenshots and folders increase, the device will automatically add more pages. The page numbers will be displayed at the bottom of the screen. By pressing the down button, you can go to page selection and select the page you want by using the plus (+) and minus (-) buttons. Folders are displayed in chronological order from latest to oldest.

TUTORIAL VIDEOS

In this section, you can find tutorial videos grouped under different titles. Select the folder you want and press the OK button. All videos inside the folder will be listed. Using the directional buttons, select the video you want to watch and press OK.

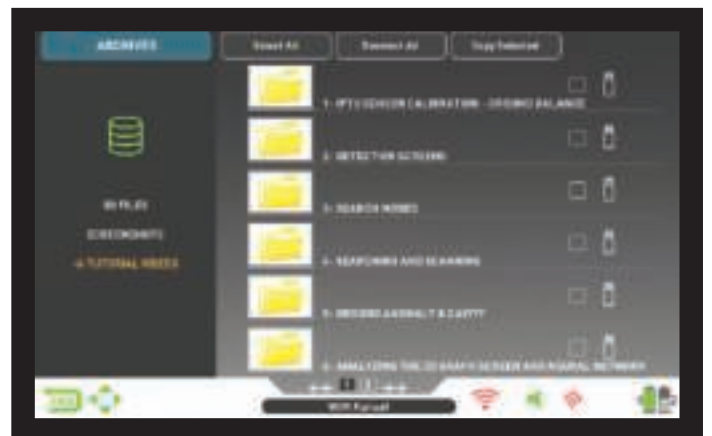

Once the video is opened, the buttons will function as below :

Plus (+) and minus (-) buttons : Controls the volume.

Up and down buttons : Allows you to navigate between the videos and fast forward and rewind them while they are playing.

OK button : Starts and pauses the video.

BACK button : Use to exit the video.

DELETING THE ARCHIVES FILES AND SAVING

You can delete multiple or individual files in the archives or save them to a USB drive.

To delete individual files :

Using the plus button (+), select the small box next to the file or folder. The box will turn orange. When you press the OK button, a check mark will appear in the box and the line will appear blurred. Click the trashcan icon next to the box and press OK. The warning message "Are you sure you want to delete the selected items?" will appear on screen. Press OK to confirm.

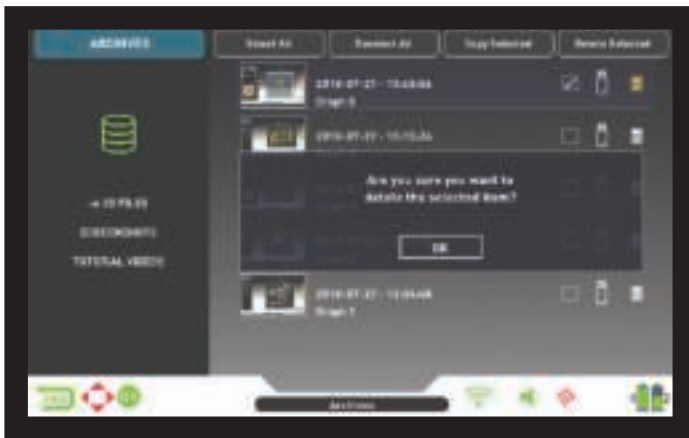
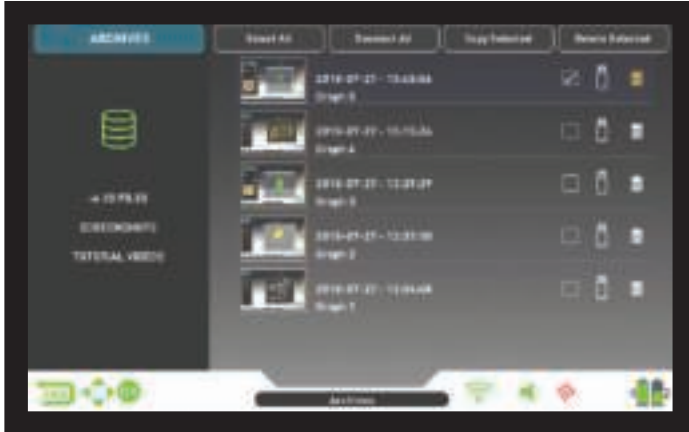

NOTE : When you want to delete multiple files, you can check the boxes next to the files and use "Delete Selected" function at the top.

To delete multiple files :

To delete multiple files or folders in the archives, when the file or the folder is selected, go to "Select All" using the up button (it will turn orange). Then press OK. All small boxes will be checked and all the lines will appear blurred. Then select "Delete Selected" at the top and press OK. The warning message "Are you sure you want to delete the selected items?" will appear on screen. Press OK to confirm.

EXTERNAL USB MEMORY USAGE

You can copy the 3D graphs, screenshots and tutorial videos to a USB drive and view them from the USB drive as well. When you insert the USB drive to the device, the USB icon in the archives screen will appear in white. Select the USB icon using the plus (+) button. The icon will turn orange and the folders inside will be listed.

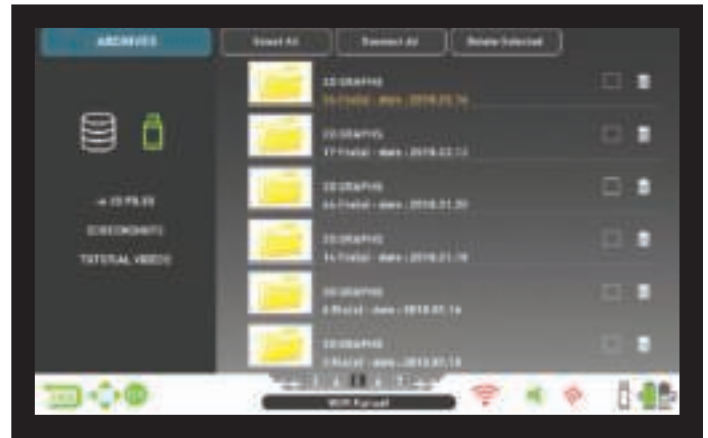

When a USB drive is inserted in the device, the USB icon will show in the archives screen and on the INFO bar. Once you exit the archives, the USB icon will no longer show on the INFO bar even if the USB drive is still attached. If you open the archives screen again, the USB icon will come back after a short period of time.

IMPORTANT! Do not remove the USB drive while in the archives screen! Be sure to exit the archives screen before you remove the USB memory.

Saving to External USB Memory

Using the plus button (+), select the small box next to the file or folder. The box will turn orange. When you press the OK button, a check mark will appear in the box and the line will appear blurred. Click the USB icon next to the box and press OK. The warning message "Are you sure you want to save the selected items to an external memory device?" will appear on screen. Press OK to confirm.

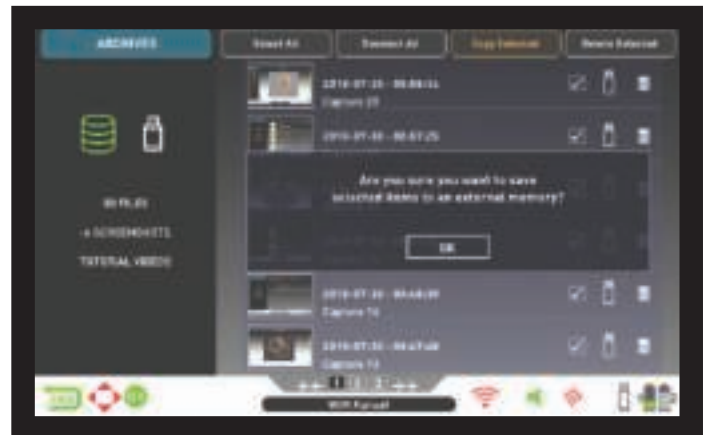

NOTE : When you want to save multiple files, you can check the boxes next to the files and use "Save Selected" function at the top.

To save multiple files or folders in the archives, while the file or the folder is selected, go to "Select All" using the up button (it will turn orange). Then press OK. All small boxes will be checked and all the lines will appear blurred. Then select "Copy Selected" at the top and press OK. The warning message "Are you sure you want to save the selected items to an external memory device?" will appear on screen. Press OK to confirm.

NOTE : If you want to cancel any of the operations while the warning messages are displayed on screen, press the BACK button.

NOTE : If there is no USB drive inserted during the save process, the message "No external memory device is available!" will appear.

NOTE : You can view the result screens and the screenshots saved on the USB drive on a computer in picture format.



Allows you to access the settings while in detection, scanning and result screens.

You can navigate between the options with the up and down buttons. Settings appear in white when unselected. They turn orange when selected.

Mode

When you press the SETTINGS button, mode is the first option selected. Allows you to select the search mode which you have determined based on targets and your search field. Select the mode using the directional buttons. The selected mode will be framed in orange and it will be active instantly! To exit the screen, press OK, BACK or SETTINGS.

Sensitivity

It is the depth setting of the device. It is also used to eliminate the ambient electromagnetic signals from the surrounding environment and noise signals transmitted from ground.

NOTE : To obtain maximum depth performance, to eliminate the noise caused by electromagnetic interference, try shifting the frequency first. In the INVENIO Pro, when the frequency shifting is not sufficient for eliminating noise, you can also change the operating frequency (5kHz / 14kHz / 20kHz) of the device.

Sensitivity setting range is 1-99 and pre-defined for each mode. All modes start at default settings. They can be manually modified when necessary. Sensitivity adjustment applies to the selected mode; the modified setting does not affect the sensitivity setting of the other modes.

When sensitivity is selected, the colored adjustment bar is displayed on screen. You can adjust the sensitivity between 1-99 using the plus (+) and minus (-) buttons. The adjusted level will be indicated by orange color on the bar and it will also be shown numerically inside the cursor.

NOTE : If the ground is highly mineralized causing the device to overload, decrease the sensitivity level until the "Overload" message disappears from the screen.

NOTE : There is no sensitivity setting in the Ground Anomaly & Cavity mode.

Sensitivity in Non-Motion Modes

Sensitivity in Basic Mode :

The factory default for the sensitivity setting is optimized in this mode. If environmental and ground conditions allow, you can get more detection depth by increasing the sensitivity setting.

During searching, if sudden changes in weather conditions, different ground structures or environmental noise is causing negative or positive drifts, re-ground balance before you change the sensitivity level. If the drifts continue, pull the trigger towards you once and

release it to manually retune the device. If the drifts still continue frequently, drop the sensitivity gradually and re-ground balance.

Sensitivity in Expert Mode :

In cases where you want to change the sensitivity setting (sudden changes in weather conditions, different ground structures or environmental noise) first re-ground balance. If there are many negative or positive drifts after re-ground balancing, pull the trigger towards you once and release it to manually retune the device. If the drifts are still present, select "Stabilizer" from the settings and increase the "AutoReset" level.

Despite all of the above-mentioned, if the drifts still exist, set the AutoReset to 1, drop the sensitivity gradually and re-ground balance. For detailed information on other settings, please read the relevant sections of the manual.

If environmental and ground conditions allow, you can get more detection depth by increasing the sensitivity setting.

Sensitivity in Motion Modes

Sensitivity in All Metal Mode :

In the All Metal mode, sensitivity setting causes an increase or decrease in the popping sounds and false signals. Sensitivity setting is a personal preference. However, It is important to set the sensitivity setting to the highest level possible where no major popping sounds are heard to avoid missing smaller and deeper targets. For example; if the noise level is suitable for searching and is the same at sensitivity levels 40 and 70, then 70 should be preferred. Using the factory default levels will be a good starting point until you get familiar and experienced with the device.

Sensitivity in fast and Deep Modes :

Since the threshold setting is not available in the discrimination modes, you can increase the depth of the device or ensure noise-free operation on different grounds only by using the sensitivity setting.

In order to adjust the sensitivity in Fast and Deep modes, first ground balance while the sensitivity is at its default setting. After ground balance is completed, hold the search coil stationary or swing over the ground at search height. Reduce the sensitivity if the device receives noise. If not (ensure that the Discrimination is also at its default settings when checking this), increase the sensitivity gradually until there is no popping sound. If the device starts to receive noise during searching, reduce the sensitivity gradually.

NOTE : Because the Deep mode offers maximum depth, it is a bit noisier than the other modes. However, due to the design characteristics of this mode, the noise will be more in the air versus in the ground. Take this fact into consideration when adjusting the sensitivity level.

Subthreshold

This setting is intended for use by more experienced users; hence it is present in the Expert mode only.

This setting enables you to see the signals on screen which fall below the threshold (falses, ground changes and metal) ; hence normally not audible.

The device sets the threshold and subthreshold levels automatically according to the sensitivity level. As the sensitivity increases, threshold level decreases. In other words, the subthreshold area gets narrower. Similarly, as the sensitivity decreases, the threshold level increases and the subthreshold area gets wider. In summary, the Subthreshold setting enables you to see the signals which fall in this area and which are normally not audible or visible.

Subthreshold setting consists of 10 levels adjustable with the plus (+) and minus (-) buttons. 0 is the factory default. As the subthreshold level is increased, the inaudible signals will be shown in gray color.

The device will not discriminate signals that fall under the threshold level.

TIP : If the signal detected with the subthreshold setting is large and you can increase the sensitivity level, you can take the signal over the threshold level and make it audible by increasing the sensitivity for an instant. This way you can check the signal and see what kind of a target it is.

Audio Boost

Boosts the sound of weak signals received from small or deep targets making it easier for you to detect those uncertain targets. It is active in the All Metal and Expert modes. It is recommended that audio boost should be used on a temporary or as-needed basis because it will not only boost the target signal audio but it will also boost the volume of ground noise and false signals along with the threshold hum.

Audio Boost consists of 5 levels. As factory defaults, the Audio Boost level is set to 3 in the All Metal mode and 5 in the Expert mode. To increase the Audio Boost level, use the plus (+) and minus (-) buttons.

Discrimination

Discrimination is the ability of the device to ignore all metals below a certain Target ID. In the discrimination process, the filtered ID range is shown on the color ID scale at the top of the screen with black color. For example, if you set the Discrimination to 30, 0-30 on the ID scale will be shown in black and the device will not produce an audio response for any metals with IDs between 0-30.

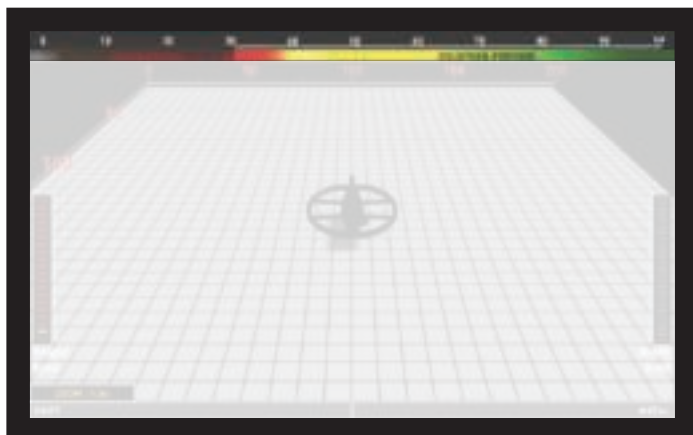

Discrimination cannot be used in Basic and Ground Anomaly & Cavity modes. The factory default for discrimination is 0 for Expert and All Metal and 10 for others.

When discrimination is selected, the colored adjustment bar with a cursor showing the discrimination level, is displayed on screen. You can adjust the discrimination level using the plus (+) and minus (-) buttons. The adjusted level will be indicated by black color on the bar and it will also be shown numerically inside the cursor.

In order to change the discrimination value, press the SETTING button and choose Discrimination. Decrease or increase the value using the plus (+) or minus (-) buttons. Please remember that certain targets,

other than the ones you want to ignore, may also be missed or their signals may become weaker when using the discrimination setting.

In the case of receiving multiple IDs for the same target – let's say 35 and 55 – due to the orientation of the target or the composition of the metal itself, if you set the discrimination to 40, because 35 will fall in the filtered range, the signal strength as well as the depth may diminish.

NOTE : Discrimination setting works inversely proportional to depth up to level 49 in Fast and Deep modes. In other words, as the discrimination is increased, stability will increase but depth will be reduced and vice versa. Above 49 though, both depth and noise will increase.

Stabilizer

This setting is present in the Expert mode and All Metal mode but it has different functions in these modes :

Stabilizer setting in Expert mode :

This feature has 2 sub-settings: AutoReset and Stabilizer. These 2 settings are shown on the right and left in the same window. Stabilizer consists of 5 levels shown in beige, AutoReset consists of 3 colors shown in gray. The adjusted level of both settings are shown in orange. If no orange bar is present, it means that both settings are off.

AutoReset and Stabilizer cannot be used simultaneously. In other words, when one is active, the other one will be off and cannot be used.

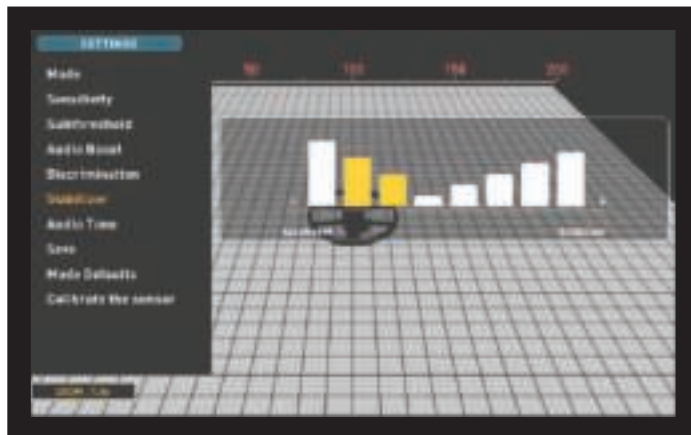

AutoReset is active in the detection screen with the IPTU sensor only. Stabilizer, on the other hand, can be used in both detection screens.

These settings are used to eliminate the drifts caused by ground and temperature changes. Drifts may happen in the positive or negative direction. During negative drifts, the Drift-Metal bar at the bottom of the screen will up to the left, in the drift direction. Because positive drifts have the same effect as metal, these will make the bar fill up to the right, in the metal direction.

To eliminate these drifts, first pull the trigger once towards you and release it to manually retune the device. If the drifts are substantial and retuning does not improve the situation, please follow the steps below :

If you are detecting with the IPTU sensor, increase the AutoReset setting gradually until the drifts are eliminated. At level 3, the device may miss weak signals. Therefore, if you suspect the presence of metal in a spot, decrease the AutoReset level to scan over the spot again.

If the drifts continue, you can increase the Stabilizer setting to 5 to eliminate the drifts. As the Stabilizer is increased, the device may detect weaker signals but will not be able to detect the targets anymore if you hold the coil stationary or sweep back and forth over the target.

If you are detecting without the IPTU sensor, you can eliminate the drifts by increasing the Stabilizer setting only as the AutoReset is

not available in this screen. Therefore, you can set the Stabilizer to maximum levels to get rid of the drifts but keep in mind that as the Stabilizer is increased, the device may detect weaker signals but will not be able to detect the targets anymore if you hold the coil stationary or sweep back and forth over the target.

IMPORTANT! You can increase the Stabilizer setting only in the detection screen. Once you go to scan screen, the device will set the Stabilizer setting to 1. AutoReset, on the other hand, will stay at the last adjusted level.

IMPORTANT! When switching from detection screen with the IPTU sensor to detection screen without the IPTU sensor, do not forget to readjust the Stabilizer setting!

NOTE : If environmental and ground changes do not cause any drifts, we recommend that you turn the AutoReset and Stabilizer settings off in detection screens with and without the sensor respectively.

Stabilizer in All Metal Mode :

For the All Metal mode to perform accurately, a stable threshold sound is necessary. You cannot search in the All Metal mode without ground balancing. Changes that occur in the soil structure and mineralization levels after ground balancing, may cause a rise or fall in the background hum and disrupt the threshold's stability which will result in false signals and thus missing signals of small metals. Stabilizer adjusts the speed that the device recovers its threshold hum and eliminates the negative effects of mineralized soils. Increasing the Stabilizer level in high mineralization will enable a more stable operation by avoiding false signals. This, however, may cause some loss in depth and it is normal.

NOTE : In high mineralization, if you receive too many false signals without disruption in the threshold hum, lower the sensitivity first before increasing the Stabilizer. If the false signals continue, set the sensitivity back to its original value and increase the Stabilizer.

If the mineralization is low, you can decrease the Stabilizer level and sweep the coil more slowly for a deeper detection.

Stabilizer consists of 10 levels. The device will start at level 6. It is recommended that Stabilizer should be increased in high-mineralization and decreased in low mineralization.

Audio Tone

Allows you to change the target audio response tones and the threshold sound according to your preference. For each metal group (Ferrous, Gold/Non-Ferrous, Non-Ferrous) the frequency can be adjusted between 150 Hz (15) and 700 Hz (70).

In the Audio Tone feature, metal groups mentioned above will be indicated by different colors: Ferrous metals by red, gold/non-ferrous metals by yellow and non-ferrous metals by green. The cursor on each metal group will display the frequency of the audio tone.



To adjust the Audio Tone, select the metal group of which you want to change the tone of, by using the plus (+) and minus (-) buttons. The

cursor will turn orange. Then, press the OK button and using the plus (+) and minus (-) buttons again, adjust the frequency.

Audio Tone feature is not present in the Basic and Ground Anomaly & Cavity modes.

If the tone break points of metal groups are changed with the Tone Break setting, the tone frequencies selected by the Audio Tone setting will apply to the new ID ranges. Details about the Tone Break setting are given on the next page.

Threshold

In the All Metal Mode, search is performed with a continuous humming sound in the background, also referred to as the threshold sound. The loudness of this hum directly impacts the detection depth of smaller and deeper targets and it is adjusted by the Threshold setting. If the threshold is set too high, a weak target signal may not be heard. On the contrary, if the threshold is too low, you give up the depth advantage this setting offers. In other words, weak signals of smaller or deeper targets may be missed. It is recommended for average users to leave this setting at its default value and for experienced users to adjust to the highest level where they can still hear the weak target signals.

When threshold is selected, the colored adjustment bar is displayed on screen. Threshold ranges between 1-99. The factory default is set to 26. You can adjust the threshold level using the plus (+) and minus (-) buttons. The adjusted level will also be shown numerically inside the cursor.

Threshold level is directly related to the Sensitivity and Stabilizer settings. Please be sure to read the related sections of the manual carefully.

Threshold setting works in the All Metal mode only.

Tracking

When tracking is on, the device continuously tracks the changing ground structures and automatically reconfigures the ground balance setting. The invisible changes in ground affect the detection depth as well as the discrimination ability of the device so it is possible to operate the device at higher performance using this feature under suitable ground conditions.

When tracking is activated, the word "Tracking" will be displayed at the top of the ground balance window and the ground balance value changes will also be show in the same window.

NOTE : Tracking does not work in non-motion modes. When tracking is active, if you switch to a non-motion mode, tracking will be deactivated and it will automatically be active again if you switch back to a motion mode.

For more information on tracking, please refer to the relevant sections of the manual.

iMask

It is used to eliminate false signals caused by ground noise or hot rocks when searching in Fast or Deep modes. It consists of 3 levels. Its factory default value is set to 1. You can change the value using the plus (+) and minus (-) buttons. The adjusted value is shown in orange. If there are no orange bars, it means that iMask is off.

If the device receives a lot of false signals due to highly mineralized soil or hot rocks in Fast or Deep modes, first re-ground balance. If the false signals continue, lower the Sensitivity and check again. In case the false signals still exist, try increasing the Discrimination value. Regardless of all these, if the false signals still exist, first change the Sensitivity and Discrimination values back to their previous levels. Then, increase the iMask level until the false signals are eliminated.

SETTINGS

At the maximum level of iMask false signals will disappear or will be minimized. However, in some cases, increasing the iMask will result in loss of depth for certain metals such as copper.

NOTE : When detecting in 20kHz with the INVENIO Pro on wet or highly mineralized ground, in order not to miss smaller high conductive metals (silver, copper etc.) it is recommended not to increase the iMask level too high.

NOTE : If the ground is not highly mineralized or does not contain many hot rocks, setting the iMask to "0" is recommended.

Notch Filter

Notch Filter is the ability of the device to discriminate single or multiple Target IDs by not emitting an audio response for them.

Although Notch Filter may seem similar to Discrimination at first glance, these two settings have different functions. While the Discrimination filters out all IDs between 0 and the set value, the Notch Filter discriminates IDs out individually.

With the Notch Filter, you can reject a single ID or multiple IDs at the same time. This process does not affect any IDs below or above the selected IDs. For example, you can filter out IDs between 31-35 as well as 50 simultaneously.

Notch Filter setting is available in Fast and Deep modes only.

How To Use The Notch Filter Setting

Notch Filter cannot be used within the Discrimination range. In other words, if the Discrimination is set to 15, Notch Filter can only be applied to IDs 16 or higher. If you want to notch out IDs 15 or below, first you need to change the Discrimination value.

To use the Notch Filter, press the SETTINGS button and using the up and down buttons, select it from the options. On the colored ID bar on screen, the first ID that you can filter out will be displayed inside the cursor. For example, if the Discrimination is set to 15, when you select Notch Filter, number 16 will be displayed inside the cursor.

Let's say you want to reject IDs between 20-25 and 40. Using the plus (+) and minus (-) buttons, select number 20 and press OK. The cursor will turn orange and number 20 will be marked with a black line on the ID bar. Then, using the plus (+) button, go to number 25 and press OK. Now, the 20-25 interval will be marked in black on the ID bar. At the same time, the first number of the notched out range (20) will be displayed under the bar and the last number of the range (25) will be displayed above the ID bar. Now, using the plus (+) button again, go to number 40 and press OK. Similarly, number 40 will be marked with a black line.



To accept back the filtered IDs, select Notch Filter from SETTINGS. The cursor will appear where you last left it and it will be white. Using the plus (+) or the minus (-) button, move the cursor onto the ID you want to accept and press OK. Along with the cursor, the black line will

turn orange and the notched out number on screen will disappear.

Iron Audio

It adjusts or turns off the volume of the low iron tone. It consists of 5 levels adjustable with the plus (+) and minus (-) buttons. Factory default is the maximum level. The adjusted level is indicated with orange color.

5 is the maximum level. As you lower it, the audio response volume the device produces for ferrous metals will decrease. When it is off, the iron audio will be silenced. In other words, the device will detect ferrous targets, the Target ID will be displayed on the screen but the device will not produce any audio response.

Iron Audio is active in Fast and Deep modes only.

Tone Break

In Fast and Deep modes, this setting is used to adjust the break points of the target response tones on the Target ID range. Tone Break points are different in these 2 modes. By using the Tone Break feature, for each metal group (Ferrous, Gold/Non-Ferrous, Non-Ferrous) you can change the point where the low tone changes into the higher tone.

When the Tone Break setting is selected, the tone break points of the metal groups will be shown inside the cursor on the colored ID bar. There are 2 tone break points in the Fast mode and 1 in the Deep mode.

To change the tone break points, go to the break point you want to change by using the right and left buttons and press OK. Then, adjust it using the plus (+) and minus (-) buttons. While adjusting, the number in the cursor will change and the cursor will move on the ID bar.

To give an example for the above explanation: let's say you are in the Fast mode and you want to change the Tone Break points. First, select Tone Break from SETTINGS. The ID bar and the tone break points of the metal groups will be displayed on the screen. Using the directional buttons, let's say you increased the ferrous metal tone break point from 40 to 45. Then, you decreased the tone break point of the gold/non-ferrous metal group from 66 to 55. In this case, the device will produce a low iron tone for all metals with IDs less than 45, a medium tone for metals with IDs 45-55 and a high tone for metals with IDs equal to and greater than 55 (If you have also adjusted the Audio Tones, the selected frequency will apply to the new ID ranges).

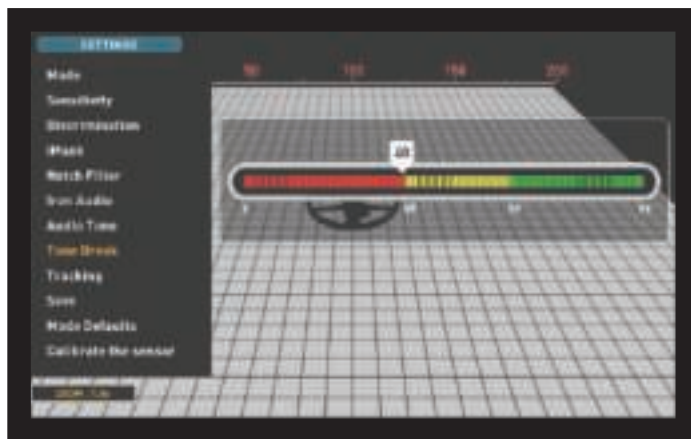

Save

INVENIO allows you to save your settings during searching. Once you saved your settings, the device will start with the saved settings upon next start up.

Save function saves the changes made in other modes as well, regardless of the mode you are in when you perform the save function. The device starts in the last mode where the save function was performed.

Save function saves all settings except for the ground balance, tracking and frequency shift.

SETTINGS

Save function works in all modes except for the Basic and Ground Anomaly & Cavity modes.

Mode Defaults

This is used to set the mode settings back to factory defaults. It restores the factory defaults for the mode currently in use and does not change the settings of other modes or the options of the device.

When you select Mode Defaults, the warning message "Current mode will be restored to factory defaults. Are you sure you want to continue?" will appear. When OK is pressed the message "Please wait..." and the progress bar will appear. When the bar is full, the device will revert back to the detection screen automatically.

Mode Defaults function works in all modes except for the Basic and Ground Anomaly & Cavity modes.

Calibrate the sensor

The IPTU sensor must calculate its height and angle to be able to

provide accurate data. For this reason, you must calibrate the sensor upon start up.

First, adjust the shaft length and coil angle to searching position. To calibrate the sensor, place the search coil on a flat surface, adjust the search coil angle so that it is parallel with the ground and lean it against a fixed object such as a tree, rock or a wall. If there is no place to lean it against, hold it stable with your hand. Press the SETTINGS button and select "Calibrate the sensor". The message "Please place the coil on a flat surface as shown in the figure and press ok will be displayed on screen. Press the OK button. You will see the message "Calibrating the sensor, please wait." Once the progress bar is full, the calibration will be completed and the device will automatically revert to the selected mode's detection screen.

PINPOINT

Pinpoint is to find the center or the exact location of a detected target.

Ground balance should be performed properly in order to ensure precise pinpointing. It is recommended to perform ground balance again before performing pinpoint operation on changing ground structures.

In the pinpoint mode, the signal tone increases in pitch and volume as the search coil approaches the target. In this mode, the device does not discriminate or give target IDs. If the device is in the vibration mode, the speed of vibration will increase as you get closer to the center of target.

Pinpoint works in the motion modes only (All Metal, Fast and Deep).

To perform pinpoint :

- 1) After a target is detected, move the search coil aside where there is no target response and pull the trigger towards you and hold it.
- 2) A red bar will appear on screen.
- 3) Keeping the trigger pulled, bring the search coil closer to the target slowly and parallel to the ground.
- 4) Signal sound becomes stronger and changes in pitch while getting closer to the target center and also the bar start filling up in gray.

5) The loudest sound indicates the center of the target. As the coil is exiting the target, the sound starts decreasing and the gray coloring turns to yellow.

6) Mark the position which provides the loudest sound using a tool or your foot.

7) Repeat the above procedure by changing your direction 90°. Actions to be performed from a couple of different directions will narrow the target area and provide you with the most exact details of the target location.

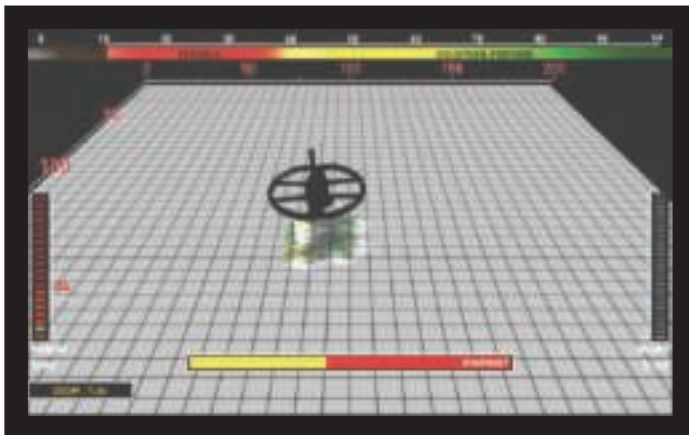

DETECTION SCREENS

INVENIO has 2 detection screens: One with, and one without the IPTU sensor. The screen with the sensor, will only function fully, when the IPTU sensor is attached to the device, and it is turned on. If the detection screen with the sensor is used while the sensor is not turned on, the device will detect targets and provide their IDs, however the advanced features (explained further in the manual) will not work. The detection screen without the IPTU sensor on the other hand, can always be used, regardless of whether the sensor is attached or not.

All modes, except for the Ground Anomaly & Cavity, will work in both screens. The Ground Anomaly & Cavity mode will work in the detection screen with the sensor only. Detection screen selection does not have direct effect on the operation of the modes. The main difference between the 2 screens is as follows: When searching in the detection screen without the IPTU sensor, the device detects targets and displays their IDs only. On the other hand, while searching in the detection screen with the IPTU sensor, apart from the IDs, the device also provides the instant depth, shape and 3D graphs of detected targets.

DETECTION SCREEN WITH IPTU SENSOR

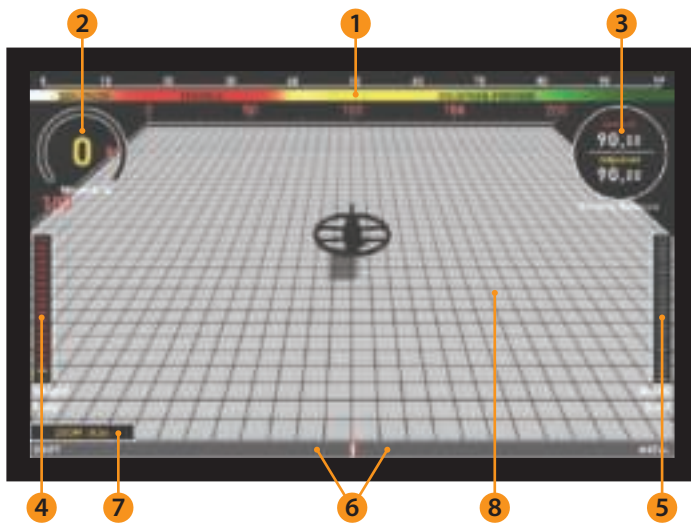

(1) Target ID Scale

Ranging from 0 to 99, this scale indicates which metal group the ID of the detected target falls in. Each metal group is indicated by a different color. For example, negative hot rocks and soil are shown by white and brown colors, ferrous metals, such as iron, by red, and gold and non-ferrous metals are indicated by yellow and green colors. When a target is detected, the cursor will point to the target ID on the scale.

The IDs filtered by Discrimination and Notch Filter settings are shown in black color on this scale. For more information please read the sections about Target ID and Notch Filter.

(2) Magnetic Mineralization Indicator

Magnetic Mineralization Indicator ranges from 0 to 99. Upon start up, the indicator will be empty and 0 will be displayed inside. Based on the level of magnetic mineralization, this chart will fill up yellow and the mineralization level will also be indicated numerically inside the chart.

This measurement can be summarized as the level of magnetic property and intensity of the ground. Simply, if you are working in an area which contains intense and magnetized minerals, the level will be high. If you are working on a less intense ground, the level will be low.

This measurement is important from two aspects. First, on grounds with high magnetic mineralization, search depth is low and users should be aware of this fact. Second, magnetic mineralization is a property which is particularly seen with mineralized rocks and this

measurement plays an important role for the device to eliminate the false signals produced by these rocks.

Magnetic Mineralization Indicator will be displayed on screen in all modes except for the Ground Anomaly & Cavity mode. You can remove it by pressing the INFO button. It will come back on screen when you press the INFO button again.

(3) Ground Balance Window

The ground balance window is divided into 2 parts: The top part shows the instant ground balance value changes while searching and the bottom part shows the adjusted ground balance value.

Ground Balance window will be displayed on screen in all modes except for the Ground Anomaly & Cavity mode. You can remove it by pressing the INFO button. It will come back on screen when you press the INFO button again.

To learn how to ground balance the INVENIO, please read the section titled "Ground Balance".

(4) Height Indicator

Shows the height of the search coil on the bar, in centimeters or inches. The ideal search height for the type of search coil attached, is indicated with green color. If you hold the search coil at a different height than the recommended one, this will be indicated by red color on the bar.

(5) Depth Indicator

Shows the depth of the detected target, in centimeters or inches. It ranges between 0 to 150+ (0-60+ in inches). In other words, for depths greater than 150cms (60"), it will show 150+ (60+ in inches). Upon target detection, the bar will rise and the target depth will be indicated numerically. Depth reading may vary based on target size and orientation, metal type and ground conditions.

IMPORTANT! To see the target depth instantly in non-motion modes, you need to swing the search coil more slowly.

(6) Drift - Metal bar

This bar is present only in the Basic and Expert modes.

All signals obtained by the device, as well as drifts, while searching, are shown on this bar.

Changes in the ground and temperature, as well as environmental noise, may lead to negative and positive drifts. During negative drifts, the bar will fill up in the DRIFT direction, in proportion to the strength of the drift.

When the device detects a metal or a positive hot rock or if a positive drift occurs, the bar this time will fill up in the METAL direction, again in proportion to the strength of the signal or the drift.

(7) Zoom

It is used to magnify or reduce target signal graphs. By using this feature, you can magnify smaller signal graphs and reduce the larger ones to better examine them.

If you wish, you can change the zoom scale with the up and down buttons.

(8) 3D Detection Ground

During searching you can observe the following on the 3D detection ground :

- * All movements of the search coil - left, right, up and down.
- * The total scanned area.

DETECTION SCREENS

* The length and width of the scanned area by zooming in and out on ground image.

* The 3D graphs of all target signals with target separation according to metal groups.

In addition, this advanced detection ground allows you to track back your scan within a certain period of time and see the detected targets.

DETECTION SCREEN WITHOUT IPTU SENSOR



The functions of the target ID scale, the magnetic mineralization indicator, the ground balance window, and the Drift-Metal bar are the same as those in the detection screen with the IPTU sensor. For this reason, these are not explained again in this section. If you wish, please read the section above titled "Detection Screen with IPTU Sensor".

(1) Target ID Indicator

Upon target detection, the ID will be displayed here. It ranges from 00 to 99 and gives an idea to the user about what the target may be.

For more details on target ID, please read the relevant section of the manual.

(2) Target Detection Screen

While searching, the signals, as well as the signal strengths of metals, positive rocks, and positive drifts can be observed in this section.

The target signals are defined by different colors just like in the color ID scale. Ferrous metals are shown in red, and non-ferrous metals are with yellow and green colors. The signals of target IDs discriminated out by Discrimination and Notch Filter settings are indicated with gray color.

SEARCH MODES

INVENIO has 6 search modes, designed for different terrains and targets. 3 of these modes are static (Basic, Expert and Ground Anomaly & Cavity) and 3 are dynamic (All Metal, Fast and Deep) modes.



Static modes are non-motion modes. In other words, the device will generate an audio response when you hold the coil stationary without swinging over the target. The audio response increases in volume as the coil approaches the target. These modes are recommended for larger and deeper metals.

Dynamic modes, on the other hand, are motion modes. You must sweep the search coil from side-to-side to detect metal. If the search coil does not move, the device will not provide any audio responses even if the coil is over a metal target. These modes are used to detect smaller targets such as coins.

The device will start in Basic mode upon initial start up. To change the search mode, press the SETTINGS button and select MODE. You can navigate between the modes using the right and left buttons and select the one you wish.

All modes, except for the Ground Anomaly & Cavity, will work in both screens. The Ground Anomaly & Cavity mode will work in the detection

screen with the sensor only. Detection screen selection does not have direct effect on the operation of the modes. The main difference between the 2 screens is as follows: When searching in the detection screen without the IPTU sensor, the device detects targets and displays their IDs only. On the other hand, while searching in the detection screen with the IPTU sensor, apart from the IDs, the device also provides the instant depth, shape and 3D graphs of detected targets.

Non-Motion Modes

IMPORTANT! For a more stable operation, try keeping the coil consistently at the same height above the ground where you retuned the detector.

IMPORTANT! If you retune the detector over metal, the drift will be in the negative side (in the DRIFT direction on the Drift-Metal bar at the bottom of the screen) and the device will no longer detect the target until the detector is retuned. In addition, the depth of the detector will also decrease.

IMPORTANT! In non-motion modes, ground balancing is very important for a deeper and more stable detection. It is recommended that you should follow the ground balance window and re-ground balance your device based on instant ground balance changes.

Basic

This mode is designed for beginners. It does not require much adjustment and can be used by adjusting the sensitivity setting only. In Basic mode, the target ID range is 00-99. 00-40 are ferrous metals and 41-99 are non-ferrous metals. In this mode, ferrous metals with ID numbers between 0 and 40 are discriminated out by factory default. Upon target detection in Basic mode, the bar at the bottom of the screen will fill up to the right, in the METAL direction in proportion to the strength of the signal.

In Basic mode, the device will generate the same audio tone for all targets but it will display the target ID on screen. At the same time, the target ID will be shown on the color ID scale at the top with the cursor.

The threshold in this mode is internal and cannot be adjusted by the user. Changes in the ground and temperature may lead to drifts in the threshold. Threshold drifts will be reflected in the bar at the bottom either in the negative way (in the DRIFT direction) or the positive way (in the METAL direction). The device emits an audible response in the positive drifts and shows the target signal. To differentiate between a positive drift and a metal signal, pay attention to the tone as well as the signal graph. If the audio response as well as the signal graph are stretching out uninterruptedly, the chances that the signal is a positive drift, are high.

During negative drifts, on the other hand, the bar will fill up in the DRIFT direction but the device will not emit any sounds. To eliminate drifts, pull the trigger towards you once and release it to manually retune the device. Retuning periodically while searching in this mode is recommended.

In the Basic mode, if the drifts are substantial and retuning does not improve the situation, drop the sensitivity gradually and re-ground balance. If the drifts continue, switch to Expert or one of the other modes to continue your search.

Expert

This mode is designed for more experienced users. Although it works the same as the Basic mode in principle, its advanced settings allow for a deeper and more stable search on all kinds of terrains.

In Expert mode, too, the device will generate the same audio tone for all targets and it will display the target ID on screen. At the same time, the target ID will be shown on the color ID scale at the top with the cursor.

In Expert mode, the target ID range is 00-99. 00-40 are ferrous metals and 41-99 are gold/non-ferrous metals. In this mode, you can use the Discrimination setting and discriminate out all IDs between 0 and the set Discrimination value and search while ignoring these targets.

The threshold in this mode is internal and cannot be adjusted by the user. Changes in the ground and temperature may lead to drifts in the threshold. Threshold drifts will be reflected in the bar at the bottom either in the negative way (in the DRIFT direction) or the positive way (in the METAL direction). The device emits an audible response in the positive drifts and shows the target signal. To differentiate between a positive drift and a metal signal, pay attention to the tone as well as the signal graph. If the audio response as well as the signal graph are stretching out uninterruptedly, the chances that the signal is a positive drift, are high.

During negative drifts, on the other hand, the bar will fill up in the DRIFT direction but the device will not emit any sounds. To eliminate drifts, pull the trigger towards you once and release it to manually retune the device. Retuning periodically while searching in this mode is recommended.

In the Expert mode, if the drifts are substantial and retuning does not improve the situation, please read the section about the Stabilizer setting in the manual.

Ground Anomaly & Cavity

This mode is designed to detect the changes and anomalies in the ground, as well as underground cavities, such as rooms, tunnels, and cellars. The results obtained in this mode are directly associated with the operator's experience level with metal detectors. Evaluating and interpreting the signals in this mode requires relatively more practice to other modes. The device can also detect metals in this mode. However, it is recommended that this mode should not be used for general metal detection but only in places where you suspect the presence of a cavity.

This mode works with the detection screen with IPTU sensor only, and it is a silent mode. In other words, the device does not generate an audio response upon detection of an anomaly or a cavity.

For more details, please read "Searching in Ground Anomaly & Cavity Mode".

Motion Modes

All Metal

Different than the Fast and Deep modes, this mode features a threshold tone which is continuously heard in the background.

All Metal mode is used in 2 different ways in the INVENIO: 1) with the Discrimination setting disabled at 0 2) with Discrimination enabled (non-zero). When the device is first turned on, Discrimination setting will be off. When the Discrimination is set at 0, the device does not discriminate targets and detects all targets (metals, mineralized rocks etc.). ID of the detected target is shown on the display (except for negative hot rocks) and the same audio tone is provided for all targets. The audio tone increases in pitch as the coil approaches the target.

When using the Discrimination setting in this mode, the device will emit a low ferrous tone for all targets below the adjusted Discrimination setting level, and a higher tone for all targets above the Discrimination setting which changes in pitch as the coil approaches the target. Let's say you set the Discrimination to 20. The device will generate a low iron tone for all metals with 0-20 ID and a higher tone for all targets with 21-99 ID. Upon target detection, the threshold will momentarily go silent and only the target audio response will be heard. The duration of the threshold's silence is directly related to the level of the Stabilizer.

Sensitivity, Threshold and Stabilizer settings in this mode are optimized to provide the best performance on different terrains. You can modify these settings based on ground conditions.

We recommend using the All Metal mode when discrimination is not important and not using it in heavy trash areas.

Fast Mode

This is the 3-tone discrimination mode designed for coin hunting especially in trashy sites such as parks. In this mode, the device produces a low tone for ferrous targets with 0-40 IDs, a medium tone for gold and non-ferrous metals with IDs 41-66 and a high tone for non-ferrous metals with IDs 67-99 such as silver, brass and copper. By using the Tone Break feature, you can adjust the break points of the target response tones on the Target ID range.

In this mode, you can use the Discrimination setting to ignore unwanted targets. The Discrimination default value is set to 10. We recommend you to change this value according to the type of targets you are searching for.

Deep Mode

Recommended especially for relic hunting. Due to its depth, this mode is a bit noisier than the other modes. However, due to the design characteristics of this mode, the noise will be more in the air versus in the ground. Take this fact into consideration when adjusting the sensitivity level.

In this mode, the device produces a low tone for ferrous targets with IDs between 0-40. For targets with IDs 41-99, it produces a higher tone which increases in pitch as the coil approaches the target. By using the Tone Break feature, you can adjust the break points of the target response tones on the Target ID range.

In this mode, too, you can use the Discrimination setting to ignore unwanted targets. The Discrimination default value is set to 10. We recommend you to change this value according to the type of targets you are searching for.

IMPORTANT! You cannot get result screens, meaning 3D graphs, in motion modes.

TURNING ON THE DEVICE AND SEARCHING

Please read the following section very carefully before operating the device. This is important in terms of getting the best performance out of your detector!

WIRELESS CONNECTION AND PAIRING

The INVENIO system box and shaft & handle communicate wirelessly. Normally, the system box and the shaft & handle are paired before they are shipped from the factory. Therefore, they will connect directly upon initial start up.

Please follow the pairing steps below if there is no connection established :

1. Be sure that the system box and shaft & handle are turned off.
2. While pressing the SCAN button on the handle, turn the ON/OFF switch on the shaft to ON position. The LED on the handle will start blinking red.
3. While pressing the Zoom In button on the system box, turn the system box on - do not let go of the button! When the pairing is successful, the LED will blink green twice and turn off. You can now let go of the button.
4. Once the pairing is done, the system box and shaft & handle will connect automatically upon start up.

NOTE : You may hear the sound of the relay circuit in the shaft during pairing; this is normal.

You can follow the status of the wireless connection from the WiFi icon the INFO bar located at the bottom of the screen. If the icon is green, it means there is connection. If the icon is red, it means there is no connection.

If the Wireless Shaft Channel is turned off in the OPTIONS, the connection will be lost, the LED on the handle will start blinking red and the WiFi icon on the INFO bar will turn red as well.

Similarly, if the connection is lost due to any reason, the LED on the handle will start blinking red. When the connection is reestablished, the LED will blink green twice.

SEARCHING

All modes of the INVENIO, except for the Ground Anomaly & Cavity, work in 2 different detection screens - one with and one without the IPTU sensor. The Ground Anomaly & Cavity mode will work in the detection screen with the sensor only. Detection screen selection does not have direct effect on the operation of the modes. The main difference between the 2 screens is as follows: When searching in the detection screen without the IPTU sensor, the device detects targets and displays their IDs only. On the other hand, while searching in the detection screen with the IPTU sensor, apart from the IDs, the device also provides the instant depth, shape and 3D graphs of detected targets.

SEARCHING IN DETECTION SCREEN WITH IPTU SENSOR

A. SENSOR CALIBRATION

1. First, adjust the shaft length and coil angle to searching position. Then place the search coil on a flat surface, adjust the search coil angle so that it is parallel with the ground and lean it against a fixed object such as a tree, rock or a wall. If there is no place to lean it against, hold it stable with your hand.
2. Turn both the system box and shaft & handle on.
3. Press the SETTINGS button and select "Calibrate the sensor".
4. Press the OK button and wait for the calibration process to be

completed. Once the progress bar is full, the calibration will be completed and the device will automatically revert to the selected mode's detection screen.

NOTE : If you will search using the detection screen without the IPTU sensor, you do not need to do the calibration process.

B. GROUND BALANCE

Especially if you will use one of the non-motion modes, you must ground balance the detector before starting to search. Ground balancing plays a big role in minimizing the false signals and obtaining target shapes. All details regarding ground balance are explained in the relevant sections of the manual.

C. SEARCHING

To obtain accurate data in the detection screen with the IPTU sensor, first be sure that the IPTU sensor is properly calibrated.

While searching in this screen, the height of the coil above the ground is critical for the sensor to obtain accurate data. For this reason, pay attention to the height indicator on the screen. The ideal search height is shown with green on the indicator. To obtain the best results while searching and scanning, pay attention to keeping the search coil within the green area.

While searching in this screen, you can see the movements of the coil in real time on the 3D detection ground. As the search coil moves forward or back, the 3D detection ground will slide. The areas scanned over by the search coil will be painted in gray on the screen. You can see how much area you have scanned by zooming in and out on the ground. When you zoom in or out on the ground, the target signals and the search coil will also be zoomed in or out. Zoom does not affect the scaling of the ground. For example, if the search coil scans an area of 1 meter while you zoom in or out on the ground at maximum, the total scanned area will still be shown as 1 meter on the result screen.

TRACE function : When you press the TRACE button and activate this function, the screen will follow the coil and rotate in the same direction. When you press the TRACE button, the word TRACE will be displayed on the INFO bar.

When you detect a target in the detection screen with the IPTU sensor, the target ID will be displayed on the cursor on the color ID bar at the top of the screen. At the same time, the signal obtained from the target will be displayed with a 3D graph and colored according to the type of target. Ferrous metals are indicated with red, gold/non-ferrous metals with yellow, and non-ferrous metals are indicated with green. In addition, the depth of the detected target will be shown on the depth indicator instantly.

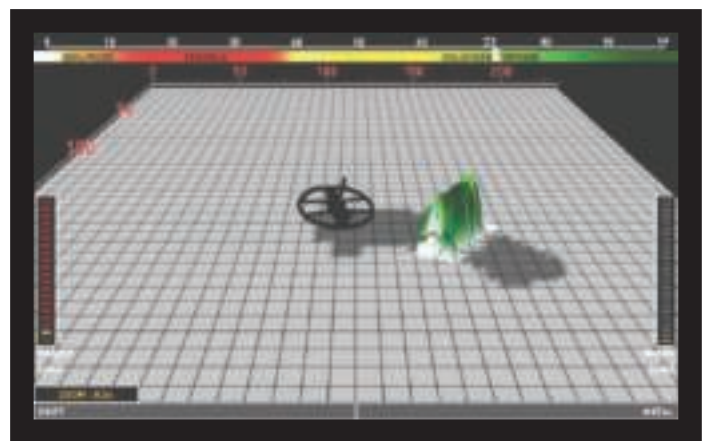

While searching in this screen, drifts may happen in both directions on the Drift-Metal bar at the bottom. When the bar fills up in the Drift direction, nothing will be displayed on the 3D detection ground, and the device will not produce any audio. When the drift happens in the metal

TURNING ON THE DEVICE AND SEARCHING

direction on the other hand, a flat, continuous graph will appear on the detection ground, and the device will produce an audio response.

In such a case, pull the trigger towards you once and release it to manually retune the device. If the drifts are still present, you can use the AutoReset and Stabilizer settings to eliminate the drifts. Please read the relevant sections of the manual for more details.

The 3D signal graph will stay on screen as long as you do not move the search coil. Once you move the coil, it will stay on screen for about 3 minutes and then disappear. As the 3D detection ground slides, the signals may fall outside the screen. If you go back to the spots where you obtained the signals within 3 minutes, you can see the 3D graphs again.

In detection screen with the IPTU sensor, you can use the CLR button to clean the screen. Each time you press the CLR button, all data on screen will be erased and the search coil will go to the origin and will be centered on screen.

You can magnify and reduce the target signals with the up and down buttons.

The usage details mentioned above are common for all modes except for the Ground Anomaly & Cavity mode. For Ground Anomaly & Cavity mode, please read the next section.

Searching in Ground Anomaly & Cavity Mode

The most important thing you need to know before using this mode is that this mode, different than the other modes, is not a "detection" mode but rather a "survey" mode. In this mode, the device will detect all ground anomalies and cavities. Anomalies include, but are not limited to the below: Different soil types within the same area, mineralized rocks, disturbed ground etc. etc. Similarly the cavities can be listed as: Rooms, tunnels, caves, cellars and graves underground. It is recommended that this mode should not be used in random fields but only in places with limited size where you suspect the presence of a cavity.

Before starting to use this mode, first be sure that the IPTU sensor is properly calibrated.

Retune height will be shown on the height indicator. By lifting the coil up to the retune height, pull the trigger back once and release. The sweep height will be marked on the height indicator. Lower the coil to the sweep height and start searching. While searching, the coil must stay within the green area on the indicator. This is very important for the device to perform correct computations.

In the Ground Anomaly & Cavity mode, all signals obtained from ground with the movement of the coil (ground effect, ground anomaly, cavity or metal), are indicated by painting on the screen. When you first start searching, the 3D graph of the signal obtained from ground appears bigger and stronger for a short period of time. Then it goes back to normal. For the device to perform accurate computation in this mode, it has to collect data for a certain period of time. Therefore, it is recommended that you scan an area of minimum 5-10m² (54-108ft²) around the suspected area.

In this mode, ground effect is indicated by yellow, metals and positive hot rocks by red, and ground anomaly and cavity are indicated by gray or blue color, based on the strength of the signal. In high mineralization, the device may paint in red color just like in positive hot rocks.

In addition, the signals of targets painted in red are shown with a peak facing upwards and the signals of targets painted in gray and blue are shown with a pit facing downwards.

In this mode, the device does not provide any audio response. All targets and signals are only shown visually on screen. For this reason, you must follow the screen carefully while searching in this more. If

needed, you can zoom in and out on the screen.

If a metal or a positive hot rock is detected, the target ID will be displayed on the ID bar at the top. The target ID bar in this mode is white and not colored like the other modes.

NOTE : In this mode, targets with IDs between 0-10 or above 97 indicate positive hot rocks. Sometimes mineralized and volcanic rocks may generate such IDs and the presence of ground anomalies is very common around them. Therefore, cavity signals obtained in such areas may not always belong to real cavities.

The 3D signal graph will stay on screen as long as you do not move the search coil just like in the other modes. Once you move the coil, it will stay on screen for about 6 minutes and then disappear. As the 3D detection ground slides, the signals may fall outside the screen. If you go back to the spots where you obtained the signals within 6 minutes, you can see the 3D graphs again.

SCANNING WITH IPTU SENSOR

Scan function works in non-motion modes only. The device will not switch to scan screen in motion modes!

To be able to obtain the 3D graphs and the shapes of the detected targets in the search screen with the IPTU sensor, you must perform a scan. In order to do this, please follow the steps below :

- a. First, step away from the area where you get the target signal.
- b. Then, press the scan button once and release. The device will switch to the scan screen. Different than the detection screen, the scan screen is a white, chequered ground.

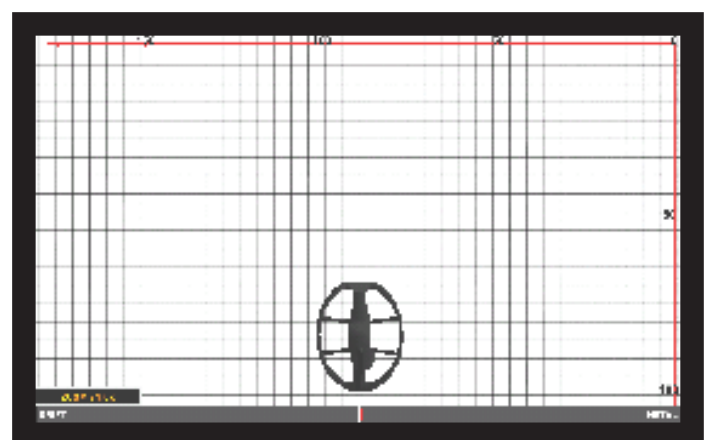

- c. Press and hold the clear button. When you see the coil centered on the screen, release the button.

d. By pressing and holding the scan button, swing the coil left to right slowly and scan over the target, starting from a bit away from where the signal is starting and until the coil is completely off the target signal. The most important things you should pay attention to while scanning are holding the search coil stable and parallel to the ground, and slightly overlapping each sweep with no gaps in between. You can see the gaps clearly on screen. If you are in the Ground Anomaly & Cavity mode, keeping the search coil height within the green area on the indicator is also very important.

NOTE : Do not let go of the SCAN button as long as you hear the target signal. If the SCAN button is released and pressed again, the shapes will not be correct and there will be gaps between the start and finish points of the scan.

Except for the Ground Anomaly & Cavity mode, the areas where the device receives a signal will be painted in red. In the Ground Anomaly & Cavity mode, on the other hand, when you first start scanning, the

TURNING ON THE DEVICE AND SEARCHING

painting will be in red or blue for a short period of time independent from the target. Then the painting will be done according to the metal type just like in the search screen.

TIP : Once the scanning is completed, if you swing the search coil over the edges of the scanned area with short sweeps and clean out the spots with no target signals, the device will obtain a much better raw data.

e. Once the scanning is completed, release the scan button.

If you want, you can scan multiple targets at the same time by holding the SCAN button pressed or scan them one by one by pressing and releasing the SCAN button each time. In each case, the 3D graphs and shapes of all targets will appear in a single result screen.

NOTE : Targets with a signal strength of more than 40 on the Drift-Metal bar located on the bottom of the screen (not present in the Ground Anomaly & Cavity) will yield better shapes. For weak signals with a signal strength of less than 40, you can increase the sensitivity to boost the signal strength.

NOTE : In the scan screen, if you scan over the targets without pressing the SCAN button, the device will produce an audio response but will not paint on screen. If you press the OK button in such a case, the device will go to the result screen but the screen will be blank.

The timing for refreshing the scan screen (data to be erased from screen) is around 8 minutes for non-motion and motion modes and around 16 minutes for the Ground Anomaly & Cavity mode. In the scan screen, different than the detection screens, the visible parts of the screen will be cleared.

IMPORTANT! If strong drifts occur once you go to the scan screen, first pull the trigger toward you once and release to manually retune the device. If the drifts are still present, press the BACK button to go to the detection screen. Then press the SETTINGS button, select the AutoReset option and adjust it to a level to eliminate the drifts. In case the drifts are still present, go to the scan screen, press the SETTINGS button and lower the sensitivity level.

IMPORTANT! If overload occurs in the scan screen, you need to press the SETTINGS button and lower the sensitivity.

To measure the field by scan process :

You can use the scan process just to measure the field you are in. In order to do this, press and hold the SCAN button, start walking in a straight direction and scan without swinging the coil. You can apply this process in all fields with different shapes, circular or square. Once the scanning is completed, release the SCAN button and press OK. An empty result screen will appear on screen. Press the OK button again and the scanned area will be shown linearly. By using the scale on the screen, you can see the dimensions of the scanned area with 94% - 97% accuracy.

The sample image below belongs to a result screen of a 200x250cm. (6.7'x8.3') scanned area.



SEARCHING IN DETECTION SCREEN WITHOUT IPTU SENSOR

While searching in the detection screen without the IPTU sensor, all target signals including false signals are shown on a running oscilloscope window with 2D graphs. Based on metal type, the target signal is shown in the same color as the ID bar at the top. The IDs filtered out by the Discrimination setting are indicated by gray color but the device does not provide an audio response for these targets.

Upon target detection, the 2D graph of the target signal will peak according to the signal strength. You can magnify or reduce the signal graph with the zoom function. Upon target detection, the Drift-Metal bar will fill up in the METAL direction and the ID of the target is shown both in the target ID window at the bottom and with a cursor on the color target ID bar at the top.



While searching in this screen, drifts may happen in both directions on the Drift-Metal bar. When the bar fills up in the DRIFT direction, nothing will be displayed on the oscilloscope and the device will not produce any audio. When the drift happens in the METAL direction on the other hand, a flat, continuous graph will appear on the oscilloscope, and the device will produce an audio response.

In such a case, first pull the trigger towards you once and release it to manually retune the device. If the drifts are still present, you can use the Stabilizer setting to eliminate the drifts. However, please remember that as the Stabilizer setting is increased, the device may detect weaker signals but will not be able to detect the targets anymore if you hold the coil stationary or sweep back and forth over the target.

RESULT SCREEN

The INVENIO allows the user to view the 3D graphs of the detected targets and analyze them.

Once you detected a metal or ground anomaly or cavity in the detection screen with the IPTU sensor, and scanned over them in the scan screen, you can now go to the result screen by pressing the OK button and analyze the obtained 3D graphs of these targets.

NOTE : The 3D graphs provided in the result screen show the general form of the target; it does not provide any details. For example, you can see the approximate shape of a statue or a gun but cannot see the details of these objects. The graphs of targets with square, rectangle, circle or stick shapes will be more clear.

NOTE : In some cases, one side of a square target may appear longer on the screen depending on the direction of your scan. Similarly, circular shapes may appear elliptical.

NOTE : If you are using the INV56 large coil, the shapes of small shallow targets may appear in a stick form.

When you go to the result screen, the top view of the target will be displayed. When the 3D GRAPH OPTIONS are displayed on the screen, to rotate the graph, you need to remove the 3D GRAPH OPTIONS from the screen by pressing the SETTINGS or the BACK button. Using the directional buttons, you can rotate the graph 360° and analyze it from all angles (this is the ROTATE function). In addition, by pressing the PAN ROTATE button you can switch to the pan function and by using the directional buttons again, you can slide the screen right and left or up and down as well as zoom in and zoom out the image.



ROTATE



PAN

You can see the following data on the result screen :

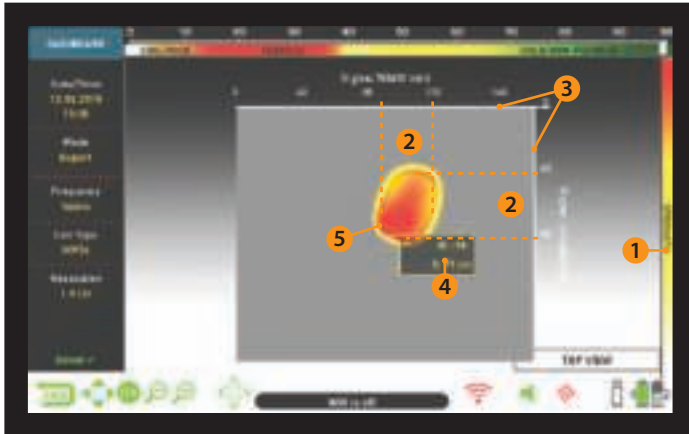

- (1) The signal strength
- (2) The length and width of the signal (the estimated target dimensions)
- (3) The scanned area and its dimensions
- (4) The estimated target depth and target ID
- (5) The estimated target shape

NOTE : If there are multiple targets in the scanned area, you can see them all in the result screen.

The targets in the result screen are indicated by colors according to the metal group they fall under just like in the detection screen. When you press the OK button in the result screen, the color target ID bar at the top of the screen and a pop-up window on the target will appear. You can see the where the target ID falls on the ID bar as well as the target ID and target depth in cms. or in inches in the pop-up window.

If multiple targets were scanned, each target will be displayed separately on the result screen. To go from one target to the other and display the target IDs and depths of each target, press the OK button.

When you are on the last target, if you press the OK button again, you can see the start and finish points of the scan as well as all the movements of the coil drawn linearly.

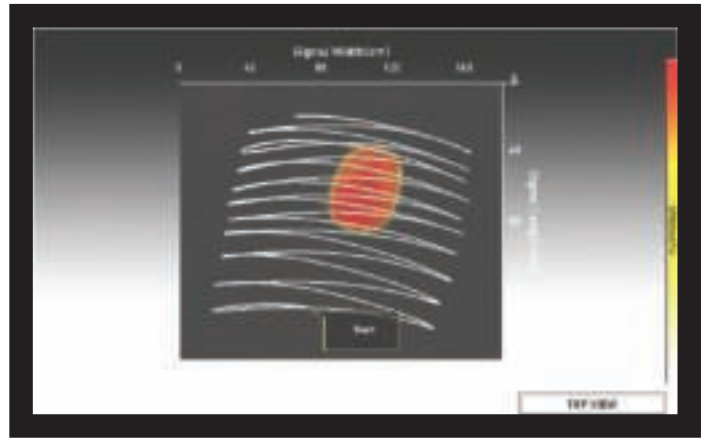

3D GRAPH OPTIONS

It is displayed on the left side of the result screen. If you wish, you can remove it from the screen by pressing the SETTINGS button and the DASHBOARD will appear on the left side of the screen instead (please read the next section).



(1) SIGNAL PROCESS LEVEL

For some targets, the device processes the obtained raw data sometimes in 4 levels and for some targets, sometimes in 5 levels and provides the data obtained either in the 4th or the 5th level. Level 0 indicates the raw data. The user can view the data in each level using the plus (+) and minus (-) buttons. In some cases, the data picked by the device may not be the most similar one to the real target. Moreover, in some cases, the raw data may be the best corresponding with the real target.

IMPORTANT! The 3rd level of the signal process always shows the data trained by artificial intelligence. For this reason, the artificial intelligence options are not displayed at this level. For details, please read the Artificial Intelligence and Neural Network section.

(2) RESOLUTION

It is used to increase the image quality of the 3D graph. The device adjusts resolution automatically based on the size of the scanned area. If you want to see the graph in more details, you need to lower the resolution.

(3) SAVE

It is used to save the 3D graph to the archives. When you select Save, the warning message "Are you sure you want to save the data?" will appear on screen. If you press the OK button, a progress bar will appear in a window. Once the progress bar is full, you will see the message "Data is successfully saved!" and the record number. When you press the OK button, the 3D Graph Options will disappear and the result screen will be displayed. Once the result screen is saved, "Delete" will be displayed instead of "Save" function under the graph

RESULT SCREEN

options and the word "Saved" will be displayed in green at the bottom of the dashboard.

NOTE : You can open the 3D graphs you saved in the ARCHIVES and perform all the functions above, later as well.

(4) DELETE

Once the result screen is saved, "Delete" will be displayed instead of "Save" under 3D GRAPH OPTIONS. When delete is selected, the warning message "Are you sure you want to delete the data?" as well as the record number will appear on screen. If you press the OK button, a progress bar will appear in a window. Once the progress bar is full, you will see the message "Data is successfully deleted!" Upon deletion, "Save" will be displayed again instead of "Delete" function.

DASHBOARD

This will show up when you remove the 3D GRAPH OPTIONS by pressing the SETTINGS button on the result screen. The DASHBOARD will display the date and time, the search mode, the frequency, and the type of search coil used when the data was obtained as well as the resolution of the graph.

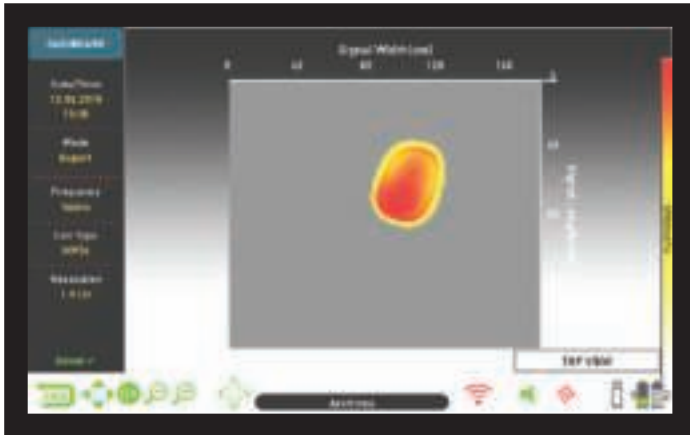

If you press the SETTINGS button while the dashboard is displayed, the 3D GRAPH OPTION will come back on screen.

If you wish, you can remove the DASHBOARD from the screen by pressing the INFO button and view the graph in a larger screen.

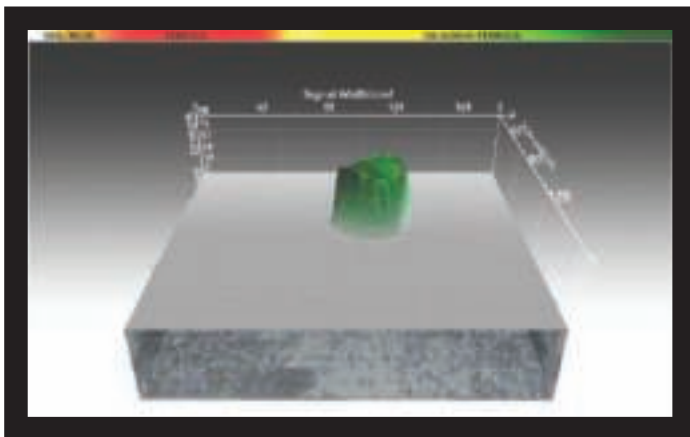

On the right is a sample result screen obtained in the Ground Anomaly & Cavity mode :

This is the initial top view:

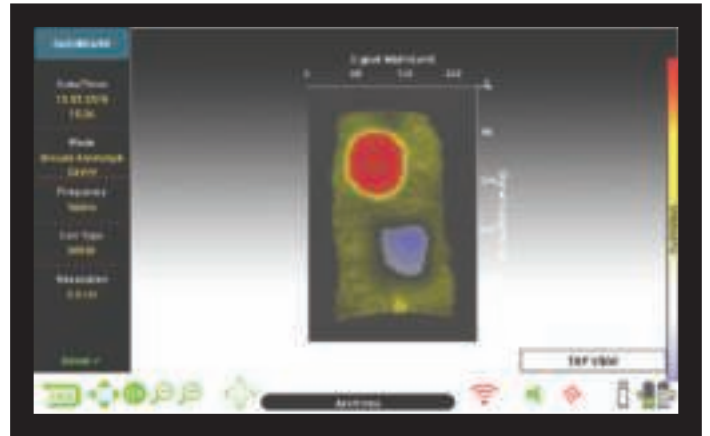

This is the 3D graph that can be viewed 360° using the directional buttons :

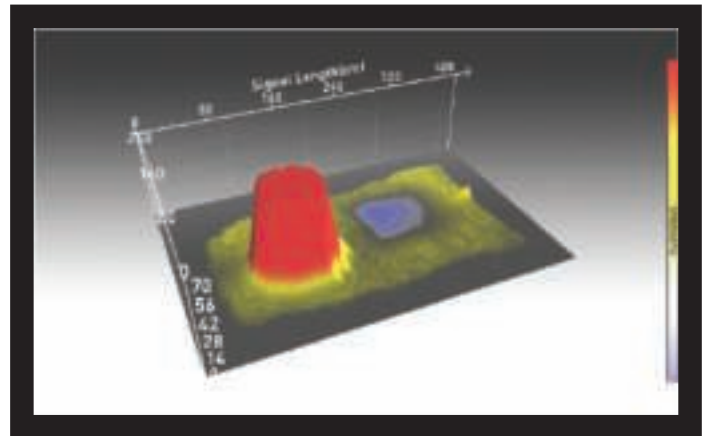

On the graph above, when you press the OK button, the below graph appears showing the target ID :

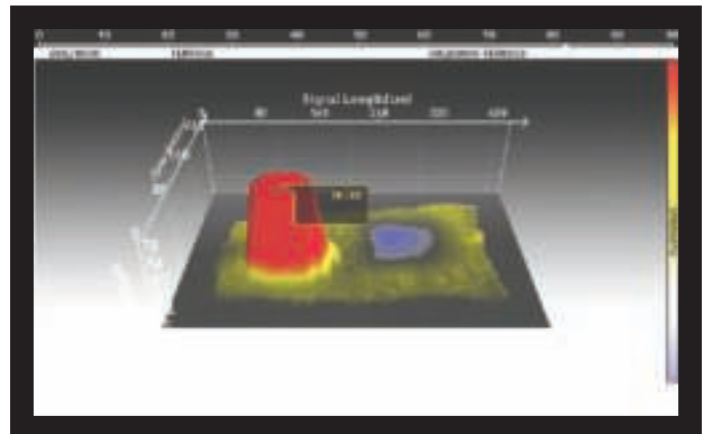

This is the graph showing the scanned area from start to finish and all the sweeps :

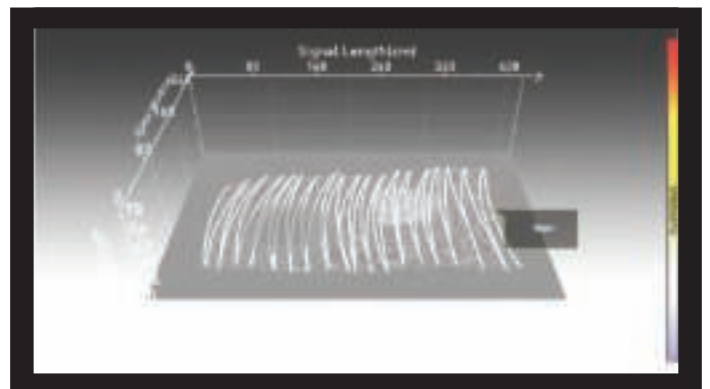

INVENIO is the world's first metal detector using artificial intelligence and artificial neural network. Let's look at what artificial intelligence and artificial neural network mean first :

Artificial neural networks are computer programs which can form and generate new information and undertake decision making processes by utilizing adaptive learning algorithms with the help of neural receivers mimicking the biological neural structure of the human brain. The technical task of the neural network is to produce an output in return for the input data. In order for the network to do this, the network is trained with certain samples. Afterwards, the network reaches the level of making sweeping generalizations and decisions. Then, the network determines the output with the ability gained.

The Artificial Neural Network enables the device to provide superior shape extractions, as well as depth indications, by utilizing adaptive learning algorithms. In other words, your device is a learning detector, and the more you train it, the better target shapes it will provide within time.

IMPORTANT! The neural network is present in the Basic and Expert modes only.

The main steps in training the detector with neural network are as follows :

During the training process, the 3D graph, ideally, should be in the top view.

1. Once you have detected a target and dug it out, you need to compare the target to the shape and signal process level provided by the device.
2. Upon performing a scan over the detected target, the device automatically displays the target shape obtained in signal process level, 4 or 5. These 2 levels are the trainable levels by the neural network.
3. First, compare the target to the shapes in 4th and 5th levels. Then, check the shape in the 3rd signal process level. The 3rd level is the level that utilizes artificial intelligence by factory default.

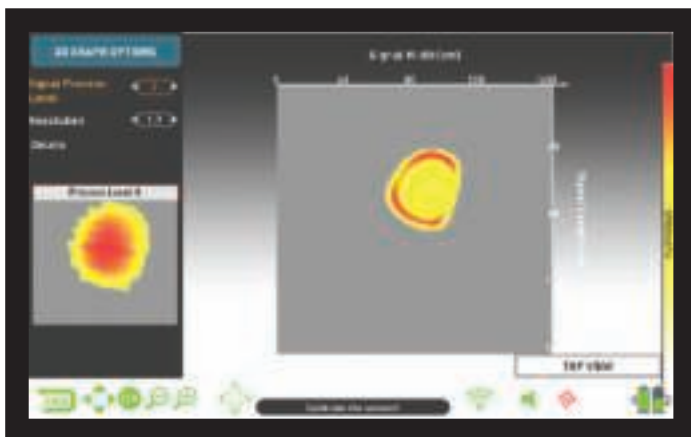

4. If the shape in the 3rd level resembles the actual target the most, you do not need to train the detector.

5. On the other hand, if one of the shapes in the 4th and 5th levels resembles the target more, you need to train the detector. In order to do this, first choose level 4 or 5 from the signal process levels.

6. Then, press the down button and select the target. The target will be marked in green.

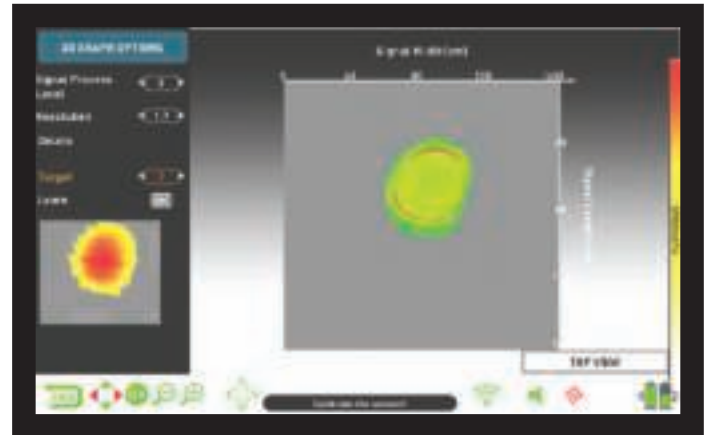

7. Upon target selection, select Learn and press the OK button. When the process is completed, a check mark will appear in the small box next to it. Pressing the OK button in the presence of a check mark means re-training the data and this is not recommended.

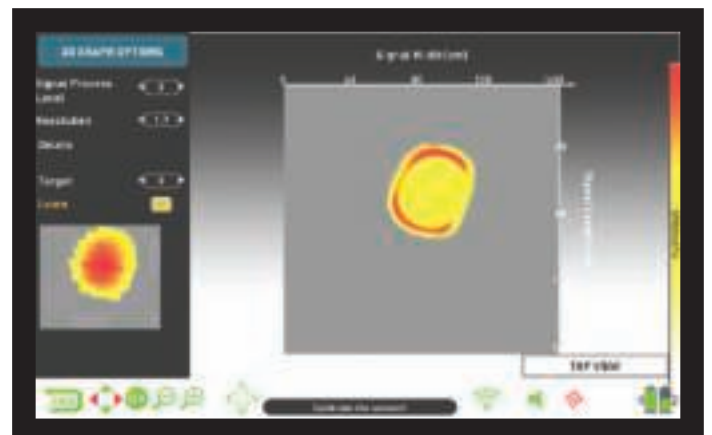
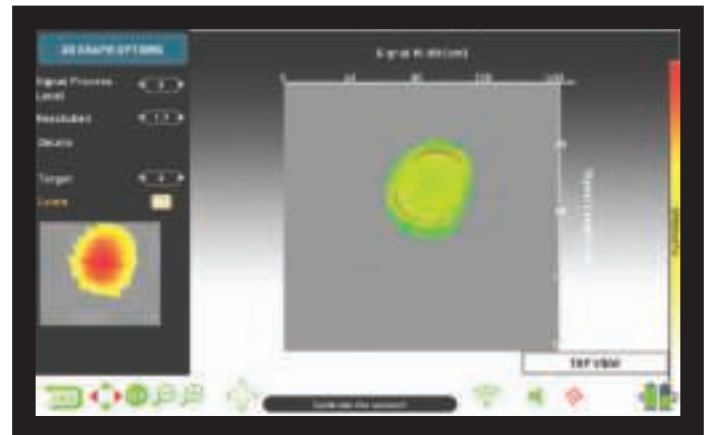

IMPORTANT! In case of multiple targets, select "Target" from the options and select the target you want using the right and left buttons. Please remember that different targets may have different signal process levels.

NOTE: You can also train the device later by opening the saved result screens in the Archives.

TECHNICAL SPECIFICATIONS

Operating System	: Embedded Linux System
Graphic Process	: OPEN GL
Sensor	: IPTU (Integrated Positional Tracking Unit)
Operating Principle	: VLF
Operating Frequency	: INVENIO : 14kHz INVENIO Pro : 5kHz / 14kHz / 20kHz
Audio Frequencies	: 150 Hz – 700Hz adjustable
Search Modes	: 3 Non-Motion (Basic / Expert / Ground Anomaly & Cavity) and 3 Motion (All Metal / Fast / Deep)
Iron Audio	: Yes
Tone Break	: Yes
Notch Filter	: Yes
Languages	: English / German / Greek / Turkish / French / Italian / Russian / Arabic / Spanish / Chinese / Persian / Bulgarian / Serbian / Romanian / Dutch / Portuguese / Polish
Ground Balance	: Automatic / Manual / Tracking
Pinpoint	: Yes
Frequency Shift	: Yes
Vibration	: Yes
Sensitivity Setting	: 01-99
Target ID	: 00-99
Search Coils	: INVENIO : INV28 Waterproof DD 28x18cm (11" x 7") INV40 Waterproof DD 40x35cm (15.5" x 14") INVENIO Pro : INV28 Waterproof DD 28x18cm (11" x 7") INV40 Waterproof DD 40x35cm (15.5" x 14") INV56 Waterproof DD 56x49cm (22" x 19")
Display	: 7" 800x480 18 Bit RGB TFT Screen
Backlight	: Yes
LED Flashlight	: Yes
Weight	: System Box : 1.7kg (with 5500 mAh battery) Shaft and Handle : 2.4kg
Length	: 121cm -152cm adjustable
Shaft Battery	: 7.4 V 5400 mAh LiPo
System Box Battery	: 7.4 V 5500 mAh LiPo
System Box Spare Battery	: 7.4 V 9500 mAh LiPo
Shaft Battery Life	: Approximately 9 hours
System Box Battery Life	: Approximately 5 hours
System Box Spare Battery Life	: Approximately 9 hours
Warranty	: 2 years
Patents	: Displaying the shape & dimensions of metals, displaying the depth of metals, displaying ground anomalies / cavities.

Nokta & Makro Detectors reserves the right to change the design, specifications or accessories without notice and without any obligation or liability whatsoever.



Nokta | MAKRO
DETECTION TECHNOLOGIES

www.noktadetectors.com



FC CE EAC

