

homeplug<sup>®</sup>  
&  
homeplug<sup>®</sup>  
PRO

**AXAL**  
POWER ⚡

# USER MANUAL.



## TABLE OF CONTENTS

<b>1. IMPORTANT SAFETY INSTRUCTIONS</b>	<b>1</b>
<b>2. PRODUCT INTRODUCTION</b>	<b>2</b>
2.1 PRODUCT OVERVIEW	2
2.2 TECHNICAL SPECIFICATIONS	3
<b>3. PREPARATION FOR INSTALLATION</b>	<b>4</b>
3.1 VERIFY BOX CONTENTS	4
3.2 INSTALLATION TOOLS	4
3.3 CIRCUIT BREAKER OPTIONS	5
3.4 RESIDUAL CURRENT DEVICE (RCD)	5
<b>4. INSTALLATION INSTRUCTIONS</b>	<b>6</b>
<b>5. OPERATION</b>	<b>12</b>
5.1 CHARGING STATUS INDICATOR	12
5.2 NETWORK STATUS INDICATOR	12
5.3 FAULT MESSAGE	12
5.4 START/STOP CHARGING HOMEPLUG	13
5.4 START/STOP CHARGING HOMEPLUG PRO	13
<b>6. HOMEPLUG APP SET UP</b>	<b>14</b>
6.1 INSTALLING THE APP	14
6.2 SIGN UP	14
6.3 CONNECTING THE HOMEPLUG	15
6.4 CHARGING MODES	17
6.5 CHARGING RECORDS	20
6.6 FAULT CHARGING	22
6.7 OTHER SETTINGS	22
6.8 SOFTWARE UPDATES	25
6.9 DEVICE SHARING	26
<b>7. INFORMATION AND WARRANTY</b>	<b>30</b>

## 1. IMPORTANT SAFETY INSTRUCTIONS

Read and follow all warnings and instructions before installing and operating the product.

- ⚠ **WARNING:** To avoid fire, injury or death, carefully read and follow the instructions during installation, operation and maintenance.
  - DO NOT put fingers into the electric vehicle connector.
  - DO NOT use the product if the flexible power cord or EV cable is frayed, insulation-broken, or any other signs of damage.
  - DO NOT use the product if the enclosure or the EV connector is broken, cracked, open, or shows any other indication of damage.
  - DO NOT remove cover or attempt to open the enclosure because of risk of electric shock
  - DO NOT install the product near flammable, explosive, or combustible materials.
- ⚠ **WARNING:** The product should be supervised when used around children.
- ⚠ **WARNING:** The product must be grounded.
- ⚠ **WARNING:** To avoid a risk of fire or electric shock, do not use this device with an extension cord.
- ⚠ **WARNING:** Disconnect electrical power prior to installing the product.
- ⚠ **WARNING:** Be sure to preview the user manual and ensure local building and electrical codes are reviewed before installing the product.
- ⚠ **WARNING:** Please ensure the product is installed following the guidelines outlined in the user manual and adhering to local safety regulations. If you feel incapable of installing the product, we recommend seeking assistance from a qualified professional.
- ⚠ **WARNING:** Do not under any circumstances make alterations to the product. Any disregard of this instruction represents a safety risk, fundamentally breaches the guarantee provisions and may void the warranty with immediate effect.
- ⚠ **CAUTION:** Use appropriate protection when connecting to the main power distribution cable.
- ⚠ **CAUTION:** Type B or C breaker with the current rating of  $\geq 32$  A should be installed.
- ⚠ **CAUTION:** Do not put heavy objects on the charger to avoid danger.
- ⚠ **CAUTION:** Do not cover the product with stickers or other objects or materials.
- ⚠ **CAUTION:** Use appropriate sun protection, moisture-proof and other equipment to protect the charging station may have a negative impact on the performance from high temperature, high humidity, high dust (such as around the beach), and other environment conditions.
- ⚠ **CAUTION:** The device must not be installed in close vicinity to running water, water jets or areas subject to flooding.
- ⚠ **CAUTION:** DO NOT remove any warranty seal or product stickers. This will void the warranty immediately.
- ⚠ **CAUTION:** DO NOT clean the product with a high pressure water cleaner or direct running water. Instead, use use a damp cloth to remove the dust.

## 2. PRODUCT INTRODUCTION

### 2.1 PRODUCT OVERVIEW

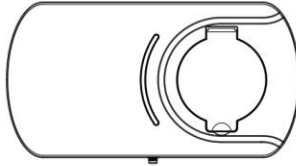

#### FRONT COVER

PROTECTS THE CHARGING MODULE FROM EXTERNAL FACTORS

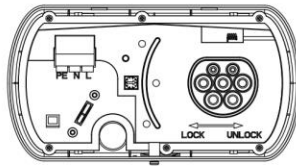

#### CHARGING MODULE

CONTAINS THE ELECTRONICS FOR CHARGING THE VEHICLE

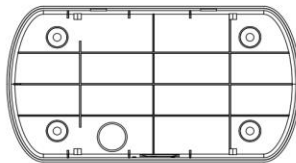

#### BACK PLATE

FOR ATTACHING THE CHARGER TO THE INFRASTRUCTURE

### 2.2 TECHNICAL SPECIFICATIONS

#### General

Dimensions	240 x 130 x 115 mm (H x W x D)
Operating temperature	-30 °C to +50 °C
Weight	1.35 kg

#### Charging

Charging power	Single-phase: 7.4 kW/32 A
Connection point	Type 2 cable (IEC 62196-2)
Voltage	230 V ±15%, single phase
Mains frequency	50/60 Hz

Built-in energy meter (±2 %)

#### Connectivity

Built-in WiFi: 2.4G Bluetooth 5.2 (for homeplug PRO version only)

#### Protection

Integrated protection for open/break fault condition in supply PEN conductor according to BS 7671:2018/A1:2020

Built-in RCD for ground fault protection (30 mA AC/6 mA DC)

UVP, OVP, RCD, SPD, Ground Fault Protection, OCP, OTP, Control Pilot Fault Protection

Degree of protection IP54

Impact resistance IK10

Standards IEC/EN 61851-1, 62196-2

Certifications CE

Warranty 24 months

### 3. PREPARATION FOR INSTALLATION

#### 3.1 VERIFY BOX CONTENTS

Check the box to ensure you have the user manual, and all required parts:

1. Ø 10 Expansion Screws x4
2. M6 Screws x4
3. M4 Anti-Theft Round Head Screws x2
4. M3 Screws x2
5. M4 Phillips flat head screws x1
6. Allen wrench x1
7. train relief x1
8. Charging station x1
9. Mounting template x1
10. User manual x1
11. Step Drill Bit x1

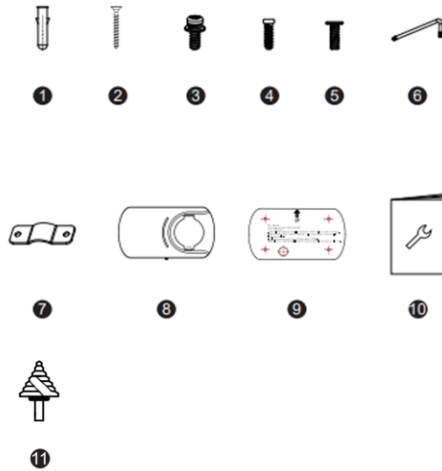

#### 3.2 INSTALLATION TOOLS

In addition, you will need the following tools and accessories:

1. Level
2. Drill
3. Soft hammer
4. Screwdriver
5. Wire stripper
6. Voltmeter or digital multi-meter (for measuring AC voltage at the installation site)

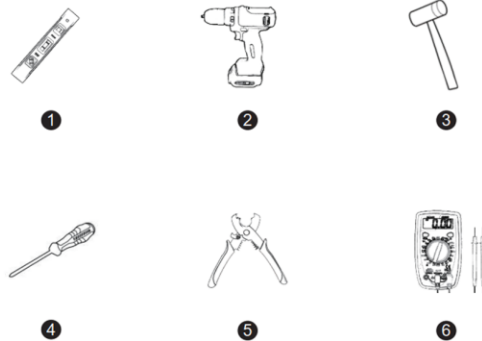

#### 3.3 CIRCUIT BREAKER OPTIONS

For safe use of electricity, please add circuit breaker protection and install a certified RCD and circuit breaker.

Circuit Breaker Option	
Single Phase	
Output Amperage (A)	32A
Circuit Breaker Options (A)	40A

**WARNING:** This device must be grounded. Disconnect all electrical power prior to installing the charging station.

**WARNING:** Improper connection of the equipment-grounding conductor would result in a risk of electric shock.

Check with a qualified electrician or serviceman if you are not sure whether the product is properly grounded. Do not modify the plug provided with the product. If it doesn't fit the outlet, have a proper installed by an electrician.

**CAUTION:** Use appropriate protection when connecting to the main power distribution cable.

#### 3.4 RESIDUAL CURRENT DEVICE (RCD)

1. A Residual Current Device is integrated in the product.

2. The RCD will break the current in case a residual current exceeding 6mA DC or 30mA AC is detected. An external RCD is required when at least one of the below conditions are identified:

- The installation, including cable, junction boxes etc., includes components with only basic insulation (Class I).
- Any other electrical equipment apart from the charging station, including lamps and socket outlets, is connected to the circuit.

#### 4. INSTALLATION INSTRUCTIONS

**WARNING:** Turn off the power before proceeding with the installation.

##### STEP 1 | DRILLING

Make sure the charging station is straight by a level and fixed at the appropriate height (1100-1200mm) from the ground.

Drill 4 Screw Holes with a diameter of 10mm and a depth of 50mm~55mm by using the mounting template.

Please drill screw holes in the direction of the template arrow.

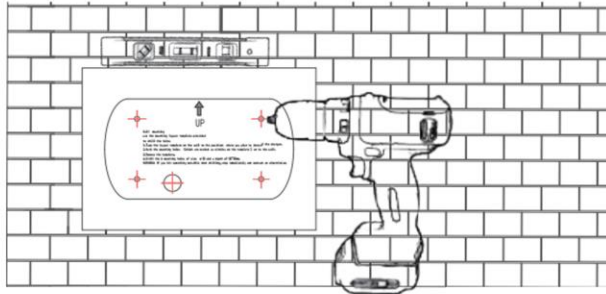

Use soft hammer to fix the expansion screws into the holes.

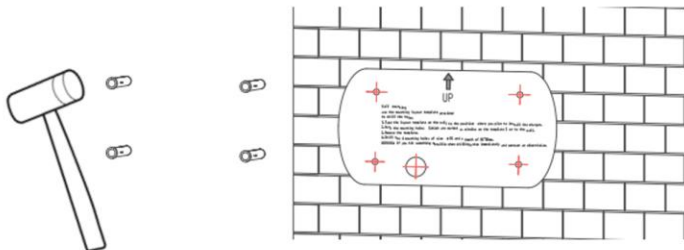

##### STEP 2 | BACKPLATE MOUNTING

Pull the power cord through the backplate; The product is designed for the cable to come out directly from the wall, alternatively from the bottom part of the black plate. Use the step drill to drill out the hole on the bottom part of the backplate in case of wiring through the bottom.

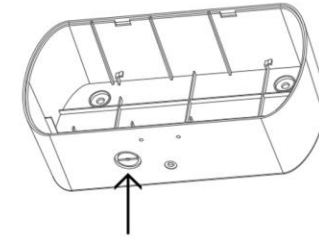

Get 4 M6 Screws from the installation kit and use a Phillips screwdriver to tighten the screws to secure the backplate on the wall.

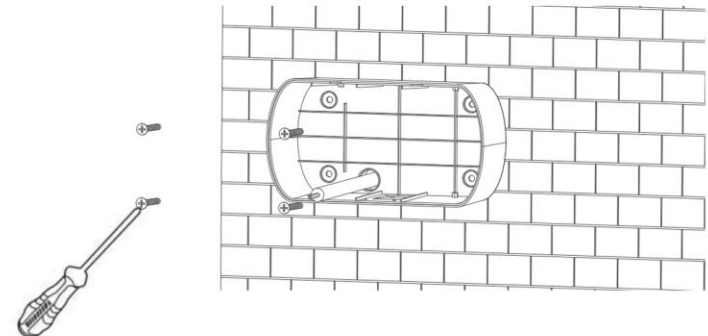

### STEP 3 | ATTACHING THE CHARGING MODULE

Put the charging module into the blackplate, follow the lock mark on the module, and slide to the right to click tight.

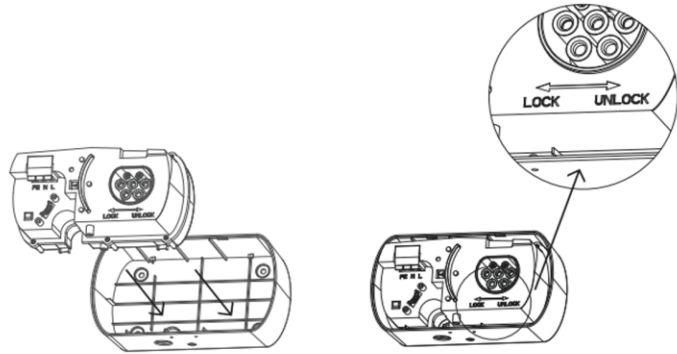

Secure the charging module with one M4 Anti-Theft Round Head Screws from the bottom.

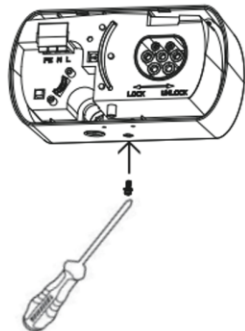

### STEP 4 | ATTACHING

- a) Use wire stripper to strip the TPU cover by 55mm first, then strip individual wires by 10 mm.

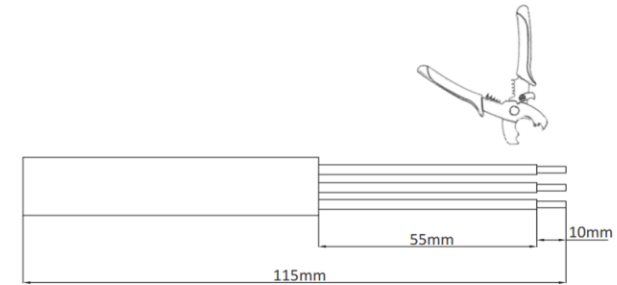

- b) Secure the power cable to the charging module with the strain relief provided by ST3.5 screws.

Green (Ground) | Blue (Neutral) | Brown (Line)

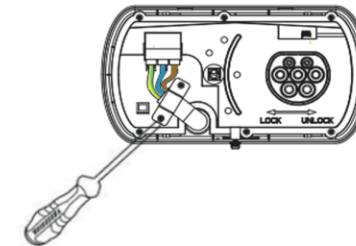

- c) Open the wire connectors by pushing upwards. Then place the cables in the correct order following the sticker and wire marks (Green, blue, brown from left to right) before firmly pressing down on all levers to close the connectors.

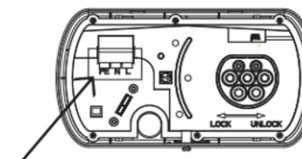

**CT clamp installation for dynamic load balancing (Optional for homeplug PRO only)**

If the CT-clamp will be installed, please wire the CT-clamp cable with the power code through power cord entrance, and connect the CT-Clamp cable head into the RS232 terminal on the charging hub.

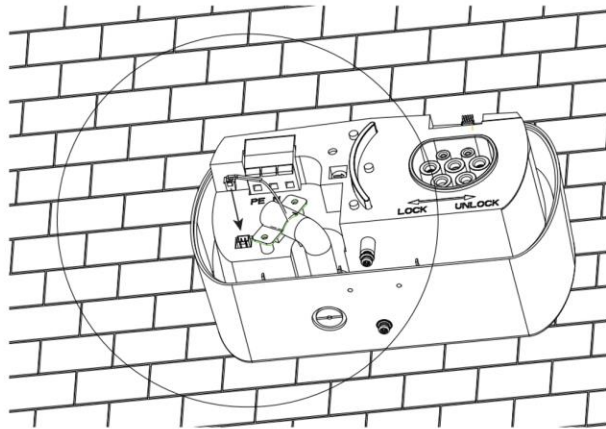

CT clamp circuit connection overview.

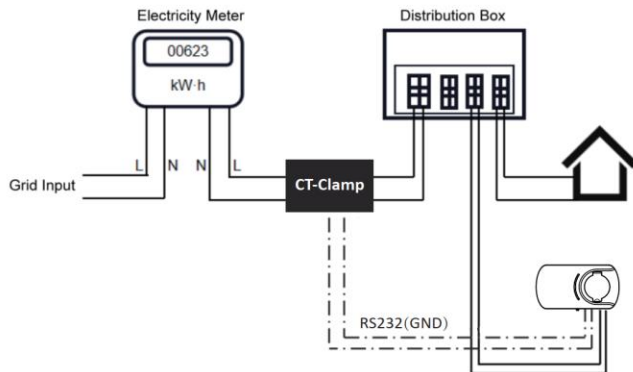

**STEP 5 | CHARGER CONFIGURATION**

Configure the charger by turning the rotary switch using a screwdriver to the correct setting.

LEVEL	0	1	2	3	4	5	6
CURRENT	6A	10A	13A	16A	20A	25A	32A

The default setting from the factory is level 6 (32A). Level 7,8 and 9 are not used for anything.

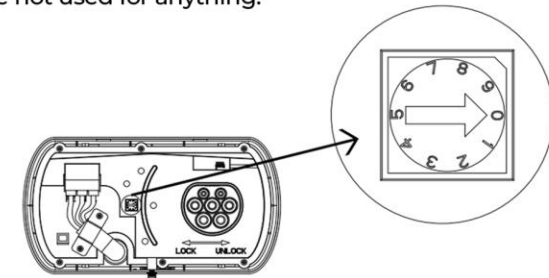

**STEP 6 | ATTACHING THE FRONT COVER**

Close the front cover and secure the front cover with an M4 Phillips flat head screws on the top and a M4 Anti-Theft Round Head Screws on and bottom.

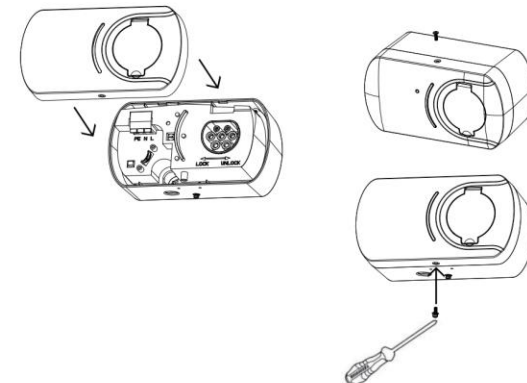

## 5. OPERATION

### 5.1 CHARGING STATUS LED INDICATOR

	Solid GREEN	Standby, waiting to plug in
	Slow blinking GREEN	Plugged in waiting to charge, communicating with vehicle
	Blinking BLUE	Charging in progress
	Solid BLUE	Finished charging
	Blinking Red	Fault

### 5.2 NETWORK STATUS LED INDICATOR (homplug PRO version only)

	Blinking GREEN	Wi-Fi connecting
	Blinking BLUE	APP connecting
	Solid BLUE	APP connected

### 5.3 FAULT MESSAGE

Fault Status	Red	Remark
Voltmeter fault	1 flash followed by 3 sec pauses	Automatic recovery
Control pilot fault	2 flashes followed by 3 sec pauses	Plug off to recover
Input UVP	3 flashes followed by 3 sec pauses	Automatic recovery
Input OVP	4 flashes followed by 3 sec pauses	Automatic recovery
OTP	5 flashes followed by 3 sec pauses	Automatic recovery
OCP	6 flashes followed by 3 sec pauses	Plug off to recover
Ground fault	7 flashes followed by 3 sec pauses	Plug off to recover
Relay fault	8 flashes followed by 3 sec pauses	Plug off to recover
RCD abnormal	9 flashes followed by 3 sec pauses	Plug off to recover
RCD self-test fault	10 flashes followed by 3 sec pauses	Restart recovery

### 5.4 START/STOP CHARGING HOMEPLUG

#### TO START CHARGING

Connect your charging cable to the charging station and the car. The car is charging when the status light changes to flashing green.

#### TO STOP CHARGING

The charging cable remains locked at the charging station until the charging process is finished or stopped by the car.

Please unlock and disconnect the charging cable from the car before disconnecting the cable from the charging station.

### 5.5 START/STOP CHARGING HOMEPLUG PRO

\*Quantitative charge mode!

With this mode, you're in full control, managing your charging sessions effortlessly from your phone. Just specify your EV battery size, for example, 80 for an 80kWh battery.

#### TO START CHARGING

1. Connect your charging cable to both the charging station and your car. (Watch for the charging status LED indicator flashing green, signalling readiness. On the app, you'll see "Insert," confirming the cable connection.
2. Launch the app on your phone and swipe right to initiate charging. Look for the charging status LED to transition to flashing blue, indicating the charging process has begun.

#### TO STOP CHARGING

- Simply tap "Click to turn off the power" on the app.
- Alternatively, disconnect the cable from your car.

Please unlock and disconnect the charging cable from the car before disconnecting the cable from the charging station.



## 6. HOMEPLUG APP SET-UP

### 6.1 INSTALLING THE APP

Download and install the App from Google Play or Apple store. Search 'Smart Life Tuya' to find the app.

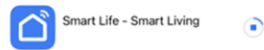

### 6.2 SIGN UP

Once downloaded, tap the 'Smart life' App icon on your home screen to open it. Tap 'Sign Up', please read the 'User Agreement and Privacy Policy' and agree with app permissions to use the app to its full potential. Enter your region and email to get the verification code.

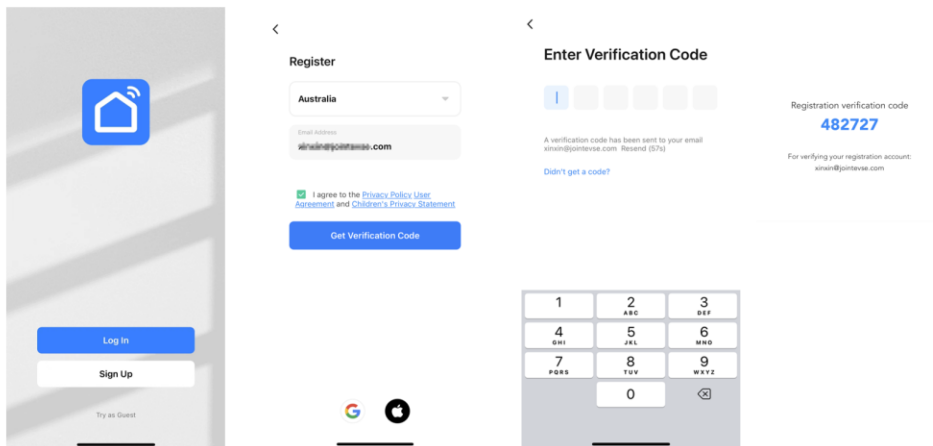

Setup your account password.

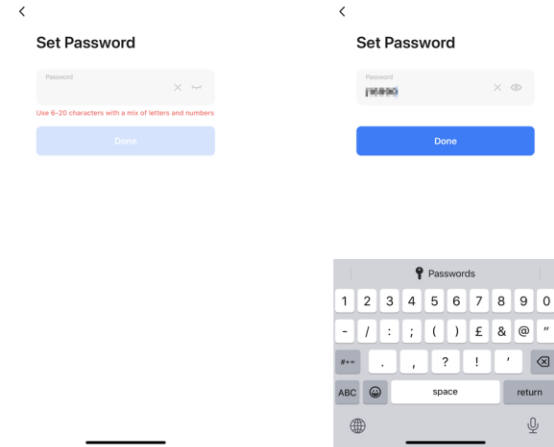

### 6.3 CONNECTING THE HOMEPLUG

Turn on your phone's Bluetooth to ensure a good signal. 'Smart life app' will request the Bluetooth permissions and click 'OK'.

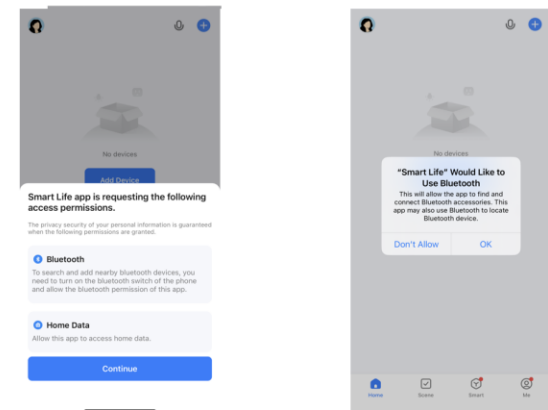

The APP will enter pairing mode to find the charger. Click 'Add'. When the charger is successfully added, you can edit the name of the charger.

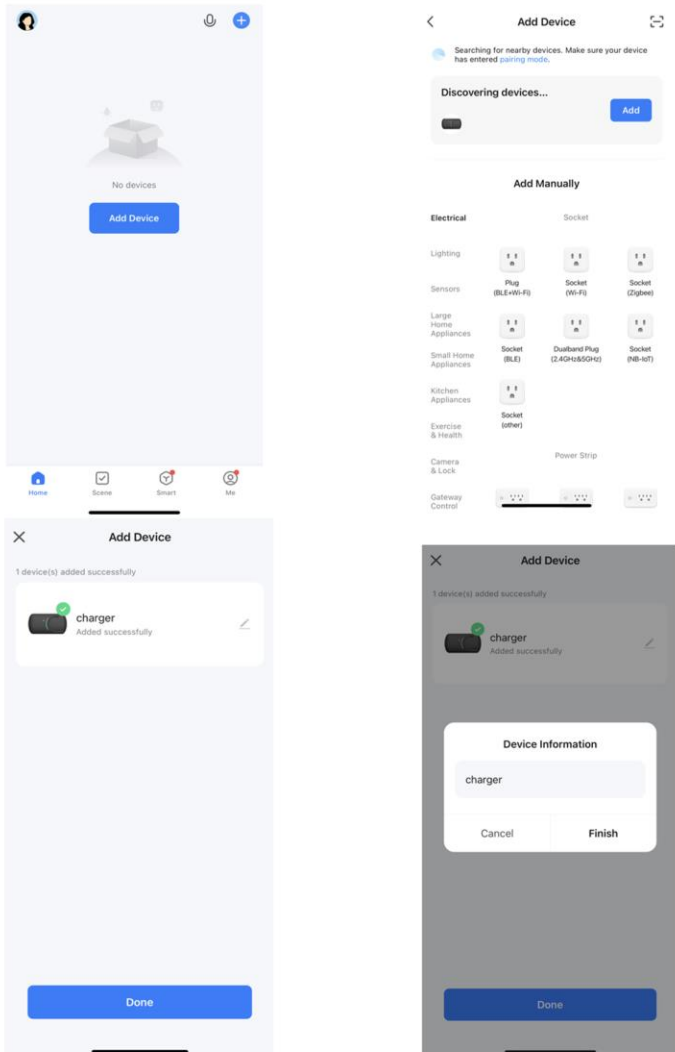

Enter your Wi-Fi account and password to connect to the Wi-Fi. Once connected successfully, it will go to the home page of the charging app.

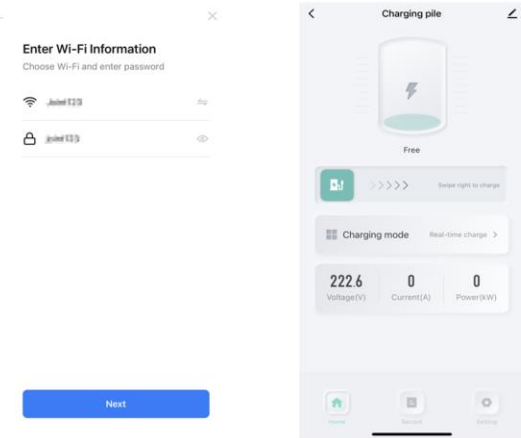

### 6.4 CHARGING MODES

The APP offers 4 charging modes, choose quantitative charging. This mode will allow you to start the charging sessions whenever you decide through a press of a button on the app. This mode will require the size of the battery of your car. Enter a numeric value like: 80 (for 80kWh).

If you prefer a plug & charge mode, choose RealTime charging.

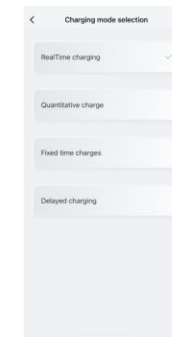

## 6.4 CHARGING MODES

### Real-time charge

You can plug in the charging connector to start charging and pull out to stop at any time, also use the APP to control the charging.

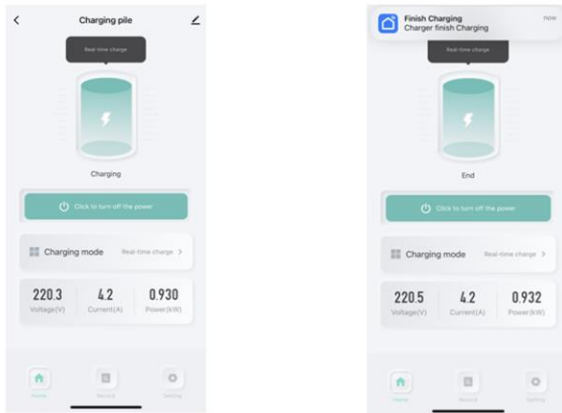

### Delayed charge

Enter the hours you want to delay to charge and confirm. The charger will wait for delayed time you set to start charging.

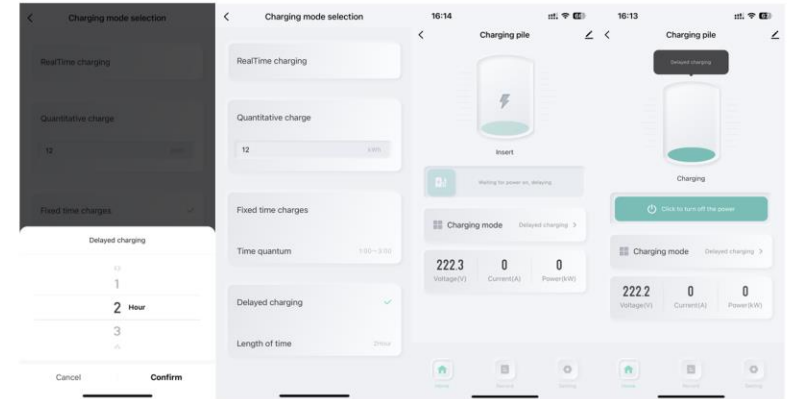

### Quantitative charge

Enter a numerical value here. 80 for a battery size of 80kWh.

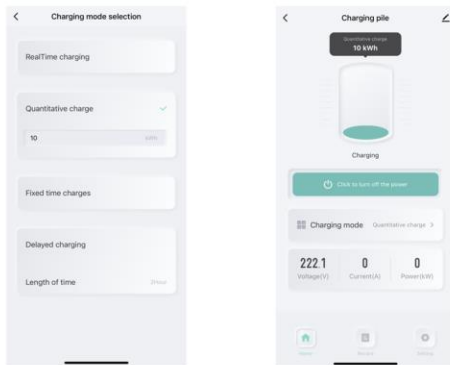

### Fixed time charge

Enter the power you want to charge and confirm. The charger will charge during these fixed times, enjoy the benefits of peak and valley electricity.

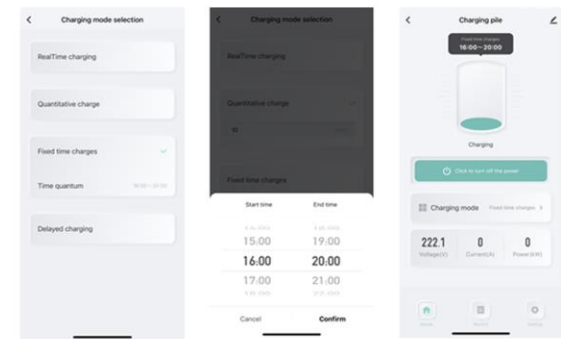

Bluetooth control while APP loses WiFi :

When the APP loses WiFi, Bluetooth will be activated within 1-2 minutes to control the charger. When the WiFi is back, it will automatically transfer WIFI control.

Charging mode execution while APP goes offline :

If you set the charging schedule under fixed-time charge or delayed charge, and plug the connector into the vehicle before the APP goes offline, the charging schedule will be executed; but won't be executed after the APP goes offline and then the connector is plugged.

### 6.5 CHARGING RECORDS

Find the function key of 'Record' at the bottom of the APP to check charging details and much more.

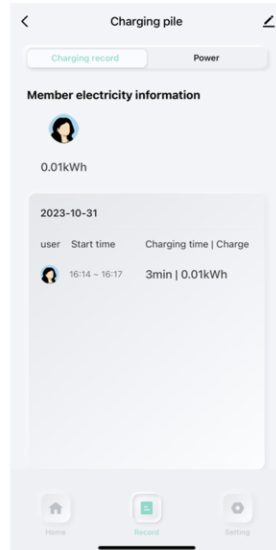

You can review your previous charging data, and power consumption by day, month and year. It is also possible to select the specific date, month and year.

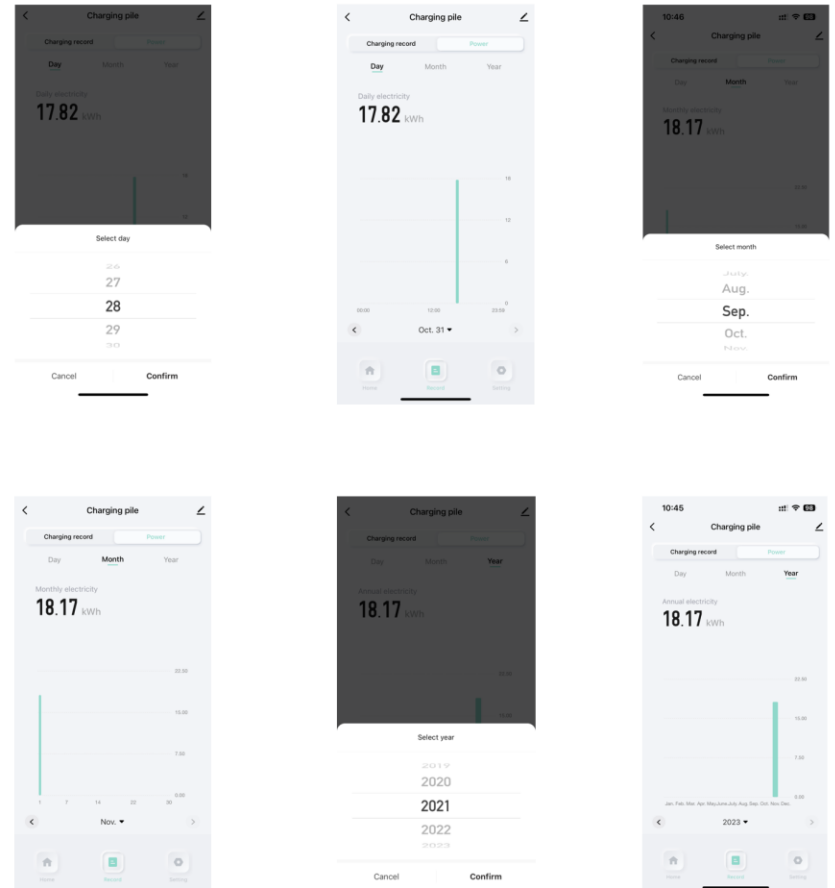

### 6.6 FAULT CHARGING

When the charger has an issue, a notification will pop up on the APP with the specific fault code. Usually, issues will be automatically solved by itself or when you restart the charger.

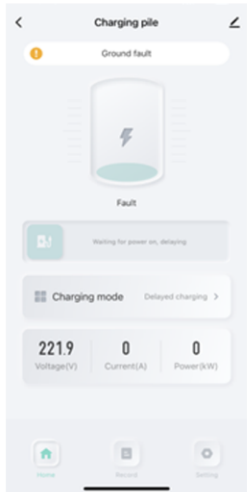

#### Main Fault Messages :

- Voltmeter fault
- Control pilot fault
- Input UVP
- Input OVP
- OTP
- OCP
- Ground fault
- Relay fault
- RCD abnormal
- RCD self-test fault

### 6.7 OTHER SETTINGS

Find the function key of 'Setting' at the APP bottom to enter settings page.

You can review alarm history on 'alarm setting'.

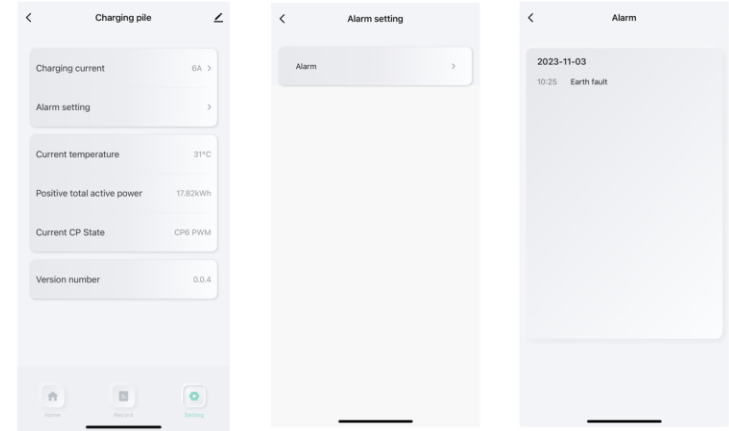

#### Current setting

Click 'Charging current' to adjust the current you preferred to charge. The current range is 6A-32A

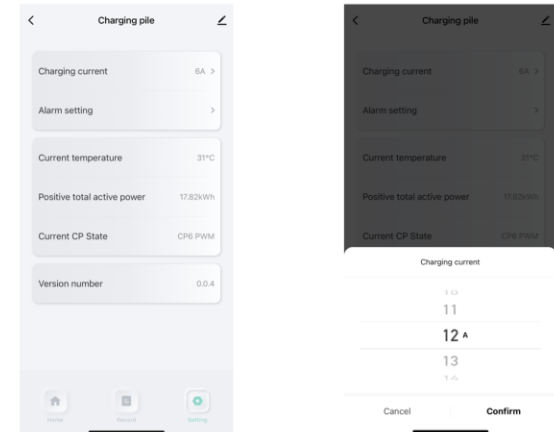

### Dynamic load balancing (for homeplug PRO version only)

When the charger has a CT-clamp installed (optional accessory), the APP will sensor the current to make 'Load switch' active.

Enter the maximum load capacity of your property by unit of A (Ampere). The easiest way is to have your electrician measure or calculate it for you.

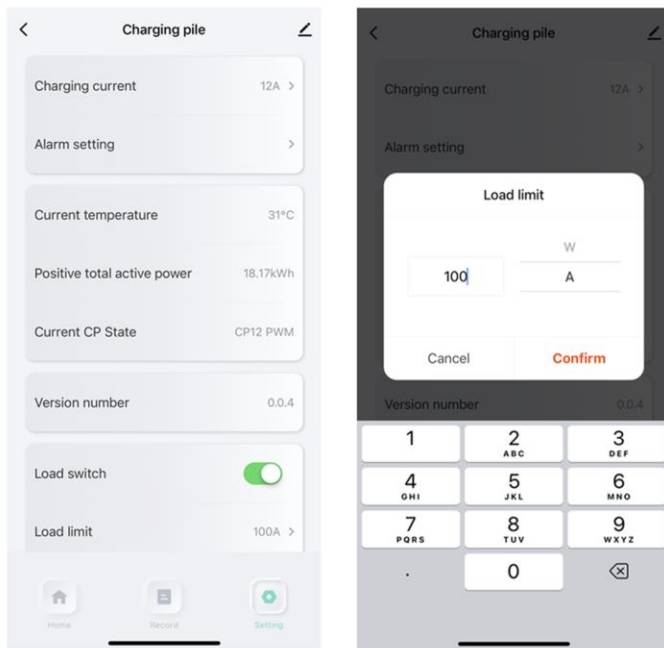

Here is how you install the dynamic load balancer:

1. The electrician will install an extra CT clamp before the main fuse of the property. This measures how much power the property is currently using.
2. The electrician brings a data cable from the CT clamp to the charger. This enables the charger to know how much electrical power the property is using.
3. After knowing the usage data and main fuse size, the charger can calculate how much power is available and adjust the charging current accordingly.
4. Main fuse rating – current draw from electrical appliances = free electrical capacity.

### 6.8 SOFTWARE UPDATES

The firmware of the charger will be updated to fix bugs and optimize functions regularly, and you can choose to update or cancel.

However, some updates are mandatory, otherwise the APP will not be available for use.

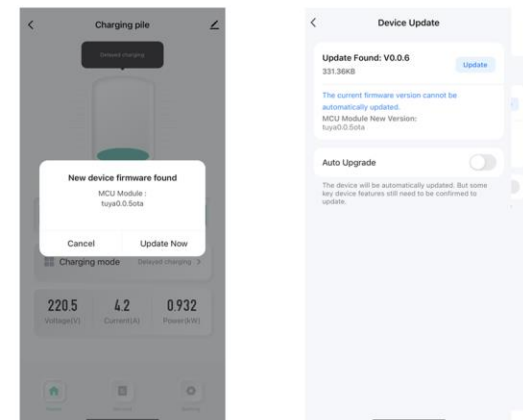

## 6.9 DEVICE SHARING

The charger is allowed to be shared with other people, if needed. Please find and click 'Pencil' icon on the top right, and click 'Share Device'. Enter the account you want, which has been registered on the APP, to share and click 'Done'.

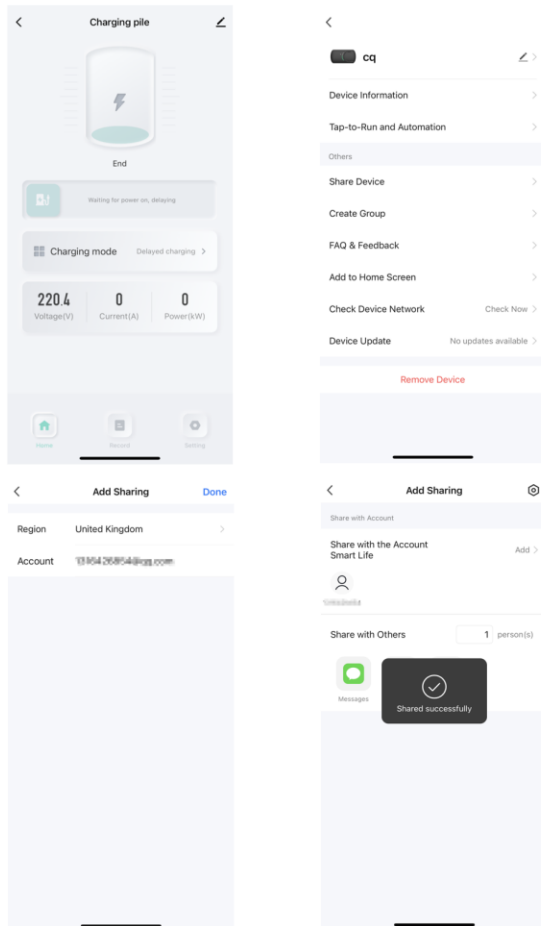

If you want to delete the account you have shared, please find and click 'Setting' icon on the top right, and click to enter the page of 'Add sharing'.

Please click 'Person' icon of the account you shared to enter the page of 'Share Device'.

Click 'Person' icon again to go to the page of 'Sharing Details'.

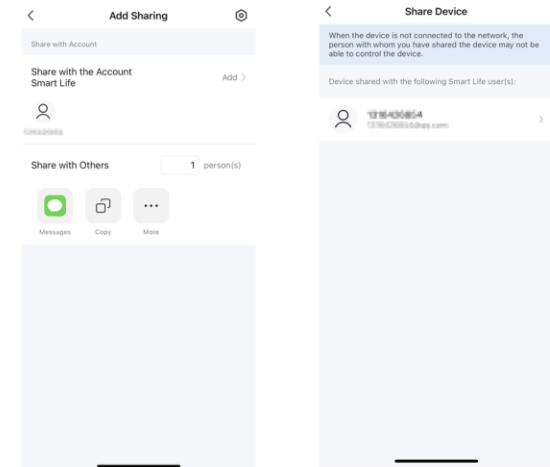

In 'Sharing Details' page, you can set validity period of shared account to be 'permanently' or within specific time. You can also 'Unshare' the account.

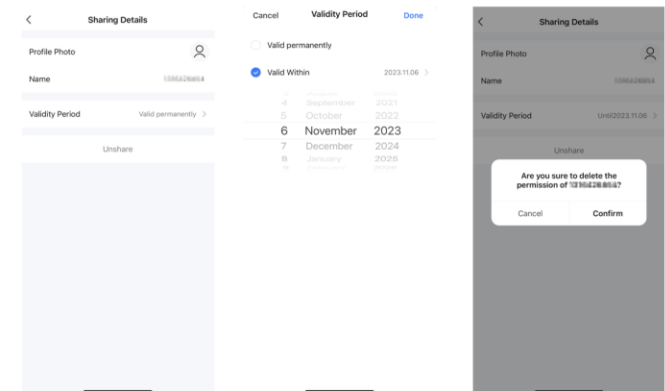

You can copy and share the invite link.

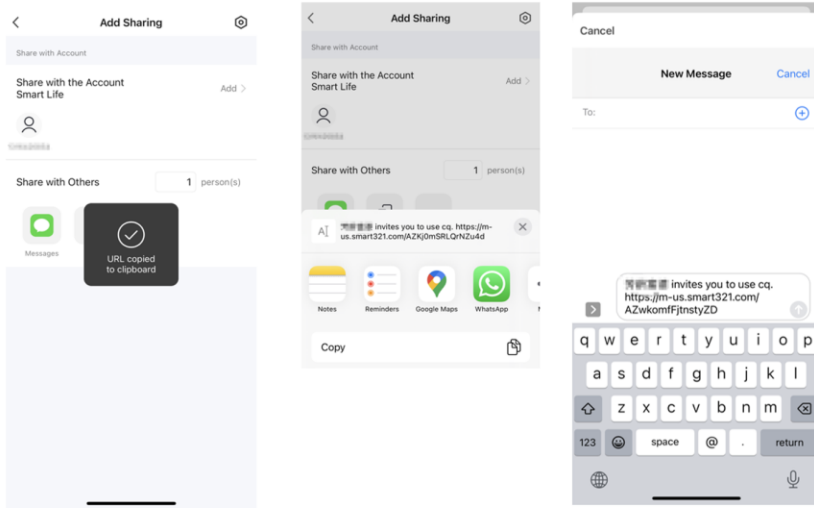



AXAL Power B.V.

V.12.12.2023.1

Kalimantanstraat 52-3, 7512 HM  
Enschede, Nederland  
Tel. +31 6 20 57 74 48  
Email. [info@axalmotors.nl](mailto:info@axalmotors.nl)



KvK N.º: 86658085  
BTW N.º: NL864038896B01

V.12.12.2023.1

### homeplug EV charger Installation Waiver & Limited Warranty

This homeplug Electric Vehicle (EV) Charger Installation Waiver and Limited Warranty Agreement ("Agreement") is entered into by and between AXAL Power B.V., a company duly organized and existing under the laws of The Netherlands, having its registered office at Kalimantanstraat 52-3, 7512HM Enschede (hereinafter referred to as the "Company"), and the homeplug customer (hereinafter referred to as the "Customer").

#### 1. Charger Installation:

The Customer acknowledges that they have purchased a 7kW homeplug or homeplug PRO EV charger from the Company, designed for possible self-installation.

#### 2. Self-Installation:

The Customer acknowledges and agrees that they have the option to self-install the EV charger. The Customer assumes full responsibility for the installation process, including compliance with all relevant local electrical codes and regulations.

#### 3. Limited Warranty:

The Company provides a limited warranty for a period of 2 years from the date of purchase. During this warranty period, the Company agrees to repair the charger free of charge for malfunctions under normal use, subject to the terms and conditions outlined below.

#### 4. Warranty Exclusions:

The warranty is subject to the following exclusions:

##### 4.1 Warranty Certificate and Proof of Purchase:

- The warranty certificate cannot be provided or the contents of the warranty certificate are modified or inconsistent with the label indication of the repaired product.

- Inability to provide valid proof of purchase.

##### 4.2 Time Limit and Conditions:

- Exceeding the manufacturer's specified warranty period (2 years).

##### 4.3 Improper Use and Maintenance:

- Damage caused by not following the product service instructions for use, maintenance, and storage.

##### 4.4 External Factors:

- Damage or malfunction caused by external objects.
- Unauthorized repair, disassembly, or modification.
- Damage caused by force majeure ('Overmacht' as in Netherlands' law BW 6:75)
- Malfunction and damage caused by other unavoidable external factors.

##### 4.5 Improper Equipment Use:

- Malfunction and damage caused by improper use of equipment, such as water or other solutions entering into the equipment.
- Any damage resulting from improper cleaning of the product, including but not limited to pressure washing, direct water streams, and similar methods, will immediately invalidate the warranty.
- Malfunction and damage caused by the grid power supply and voltage not specified for use with the charger equipment.
- If the warranty seal on the charging module has been broken or if the factory sticker is absent, the warranty will be invalidated.

#### 5. Waiver and Release:

In consideration of the purchase of the homeplug EV charger, the Customer hereby waives, releases, and discharges the Company, its employees, agents, and representatives from any and all claims, liabilities, damages, losses, or expenses arising out of or in connection with the installation, use, or malfunction of the EV charger, whether during or after the warranty period.

The information contained in these documents is confidential, privileged and exclusively for the information of the intended recipient and may not be used, published, or redistributed without the prior written consent of AXAL Power B.V.

**6. No Other Warranties:**

The above guarantees constitute the sole and exclusive warranty provided by the Company. No other express or implied warranties are made, including implied warranties of merchantability, fitness for a particular purpose, or adaptability.

**7. Limitation of Liability:**

In no event shall the Company be responsible for any special, incidental, or consequential damages arising out of or in connection with the homeplug EV charger, whether in contract, civil negligence, or other aspects.

**8. Governing Law:**

This Agreement shall be governed by and construed in accordance with the laws of The Netherlands.

**9. Acknowledgment:**

The Customer acknowledges that they have read this Agreement, understand its terms, and voluntarily agree to be bound by its provisions.

IN WITNESS WHEREOF, the Customer has executed this Electric Vehicle Charger Installation Waiver and Limited Warranty Agreement as of the date of purchase of the product.

**10. Customer Responsibility:**

The Customer acknowledges and agrees that the Customer is solely responsible for the proper installation of the EV charger. The Company shall not be held liable for any damages, injuries, or losses arising out of or in connection with improper installation, including but not limited to:

**10.1 Device Breakage:** The Customer understands and accepts that any breakage or damage to the EV charger resulting from incorrect installation, misuse, or mishandling is the sole responsibility of the Customer.

The information contained in these documents is confidential, privileged and exclusively for the information of the intended recipient and may not be used, published, or redistributed without the prior written consent of AXAL Power B.V.

**10.2 Fire or Safety Hazards:** The Customer acknowledges that incorrect installation may pose fire or safety hazards. The Company explicitly disclaims any responsibility for damages, injuries, or losses resulting from such hazards caused by improper installation.

**10.3 Indemnification:** The Customer agrees to indemnify and hold the Company, its employees, agents, and representatives harmless from any claims, liabilities, damages, losses, or expenses, including legal fees, arising out of or in connection with any improper installation of the EV charger.

**10.4 Professional Assistance:** The Customer is strongly encouraged to seek professional assistance if they are uncertain about the proper installation procedures. The Company recommends consulting with certified electricians or professionals with expertise in electrical installations to ensure the safe and accurate setup of the EV charger.

**11. Assumption of Risk:**

By accepting this Agreement, the Customer expressly assumes all risks associated with the installation of the EV charger. The Customer acknowledges that they have been informed of the potential risks and hazards, including but not limited to device malfunction, breakage, fire, and safety issues resulting from improper installation.

**12. Release and Waiver:**

The Customer hereby releases and discharges the Company, its employees, agents, and representatives from any and all claims, liabilities, damages, losses, or expenses arising out of or in connection with improper installation of the EV charger, whether during or after the warranty period.

The information contained in these documents is confidential, privileged and exclusively for the information of the intended recipient and may not be used, published, or redistributed without the prior written consent of AXAL Power B.V.

AXAL Power B.V.

V.12.12.2023.1

Kalimantanstraat 52-3, 7512 HM  
Enschede, Nederland  
Tel. +31 6 20 57 74 48  
Email. [info@axalmotors.nl](mailto:info@axalmotors.nl)

KvK N.º: 86658085  
BTW N.º: NL864038896B01



V.12.12.2023.1

### AXAL Power B.V. – RETURN POLICY

Thank you for shopping with AXAL Power B.V. . We are committed to providing you with the best shopping experience possible. If you are not entirely satisfied with your purchase, we're here to help.

#### Returns

You have 30 calendar days to return an item from the date you received it. To be eligible for a return, your item must be unused, in the same condition that you received it, and in the original packaging with all tags and labels attached. Your item needs to have the receipt or proof of purchase.

#### Refunds

Once we receive your item, we will inspect it and notify you that we have received your returned item. We will immediately notify you on the status of your refund after inspecting the item.

If your return is approved, we will initiate a refund to your original method of payment. You will receive the credit within a certain amount of days, depending on the policies of your card issuer's/your bank's policies.

#### Exchanges

If you wish to exchange your item for a different power rating, color, or product, please contact our customer service team. We will guide you through the exchange process and provide assistance in finding the right replacement.

#### Shipping

You will be responsible for paying for your own shipping costs for returning your item, unless you purchased your product on bol.com or amazon.com (then the specific terms&conditionsofthoseshopsapply).Shipping costs are non-refundable.If you receive a refund, the cost of return shipping will be deducted from your refund.

#### Contact Us

If you have any questions about our return policy, please contact us at [info@axalmotors.nl](mailto:info@axalmotors.nl) or call us at +31 (0) 6 20 57 74 48. Our customer service team will be happy to assist you and provide any necessary information.

#### Damaged or Defective Items

In the unlikely event that you receive a damaged or defective item, please contact us immediately. We will work with you to arrange for a replacement.

#### Exceptions

Certain items, such as personalized or customized products may not be eligible for return due to their nature. Please review the product description carefully before making a purchase.

##### 1. How to Initiate a Return

To begin a return, please follow these steps:

- Contact our customer service team at [info@axalmotors.nl](mailto:info@axalmotors.nl) or call us at +31 (0) 6 20 57 74 48 to inform us about your intent to return the item.
- Provide your order number, the item you wish to return, and the reason for the return.
- Our customer service representative will guide you through the return process and provide you with a Return Merchandise Authorization (RMA) number (if you are entitled to a return).

##### 2. Packaging and Shipping

When shipping the item back to us, please ensure the following:

- Securely package the item in its original packaging to prevent damage during transit.
- Clearly mark the RMA number on the outside of the package.
- Use a trackable shipping method to ensure the safe delivery of the item.

The information contained in these documents is confidential, privileged and exclusively for the information of the intended recipient and may not be used, published, or redistributed without the prior written consent of AXAL Power B.V.

· You will be responsible for the shipping costs associated with returning the item. Shipping costs are non-refundable.

### 3. Inspection and Approval

Once we receive the returned item, our quality control team will inspect it to ensure it meets the return eligibility criteria. We will notify you of the receipt and inspection status of the item.

### 4. Refunds

If your return is approved, we will initiate a refund to your original method of payment. The refund process may take up to 15 business days, and the timing of the credit's appearance on your account may vary based on your financial institution.

Please note that any discounts, promotions, or coupons used during the original purchase will be factored into the refund amount.

### Final Note

Our goal is to ensure your satisfaction with every purchase. If you have any concerns or questions about our return policy, please don't hesitate to reach out to us. We appreciate your business and are committed to resolving any issues to your complete satisfaction.

AXAL Power B.V.

[www.axalpower.com](http://www.axalpower.com)

Customer Service Contact Information:  
[info@axalmotors.nl](mailto:info@axalmotors.nl) / +31 (0) 6 20 57 74 48

The information contained in these documents is confidential, privileged and exclusively for the information of the intended recipient and may not be used, published, or redistributed without the prior written consent of AXAL Power B.V.

### Commercial terms & conditions

**General:** Delivery of products and payments are made in accordance with the AXAL Power B.V.'s General Terms & Conditions and General Delivery terms with the exclusion of purchasing and payment conditions set by third parties.

**Validity:** Quotations and offers are valid for 30 days after quotation date, for specified quantities and undivided orders.

**Delivery:** Details to be discussed after contract approval. \*All orders defined under EXW (Ex Works) Incoterms (International Commercial Terms), unless otherwise agreed.

**Retention of title:** The delivered products & installation remains the property of AXAL Power B.V. until the full payment obligation has been met.

### General Terms & Conditions and General Delivery Terms:

AXAL Power B.V.'s General Terms & Conditions and General Delivery terms, as found on the footer of the Company's website, apply to this contract. While not reproduced in this document, any overlapping terms from those documents are still valid and are considered an integral part of this Agreement.

### Website Reference:

The Customer acknowledges that the General Terms & Conditions and General Delivery terms referenced herein can be found in the footer of AXAL Power B.V.'s official website. The Customer is responsible for reviewing and familiarizing themselves with the terms and conditions available on the website.

**IN WITNESS WHEREOF**, the Customer has executed this Electric Vehicle Charger Installation Waiver and Limited Warranty Agreement, including the Customer Responsibility and General Terms & Conditions sections, as of the date of purchase of an AXAL product.

The information contained in these documents is confidential, privileged and exclusively for the information of the intended recipient and may not be used, published, or redistributed without the prior written consent of AXAL Power B.V.