

A

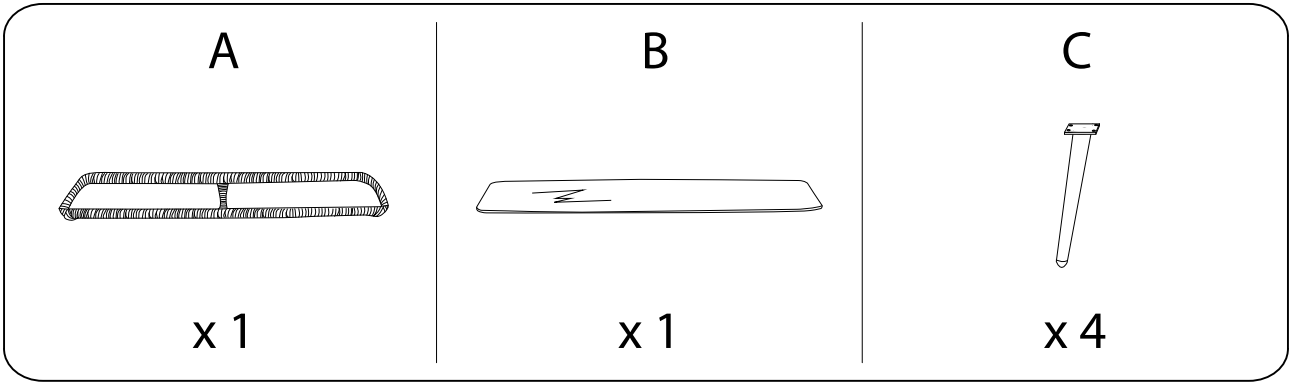

B



A

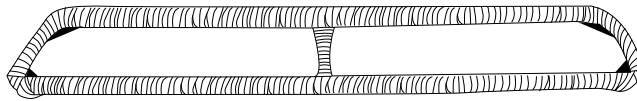

C x 4

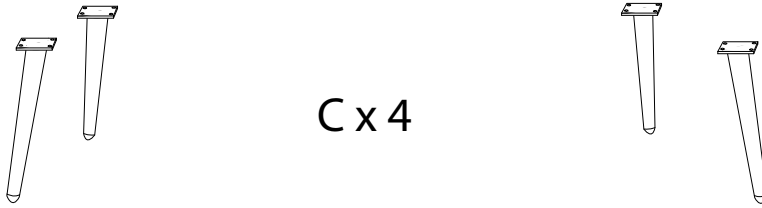

D

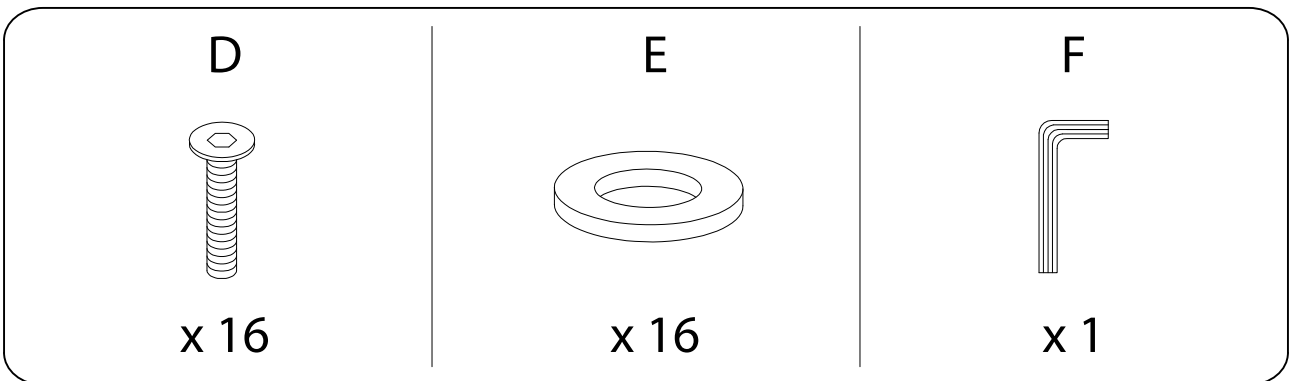

1

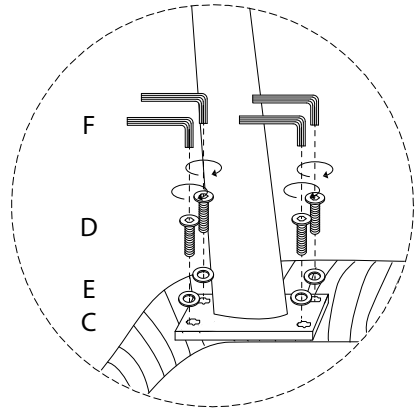
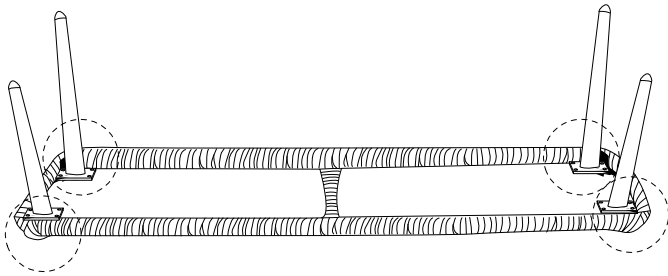
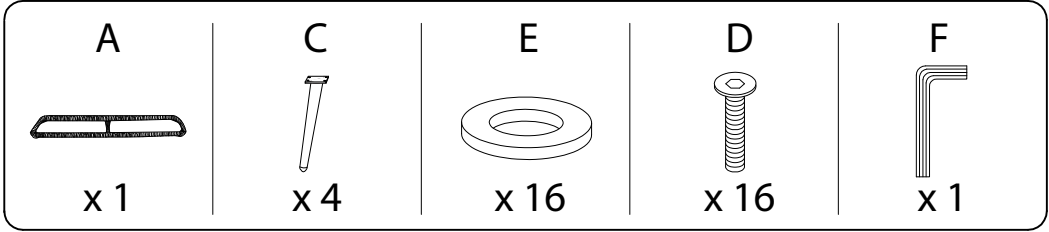

2

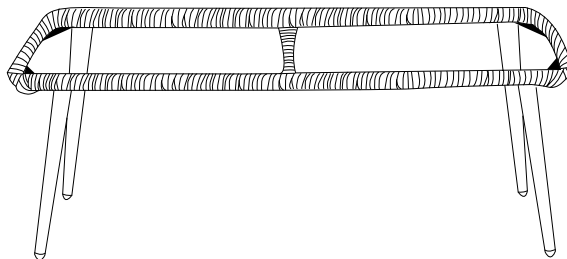
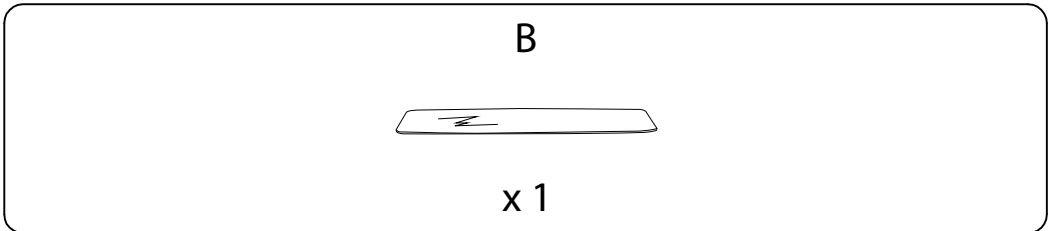

B

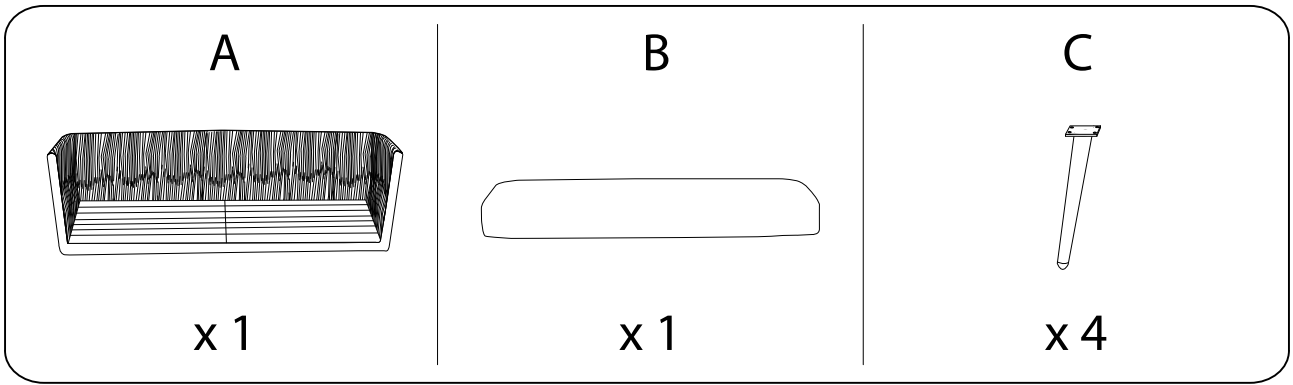

G

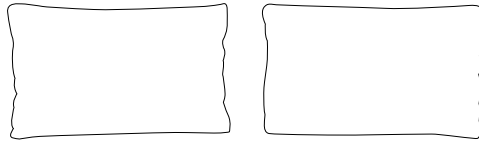

B



A

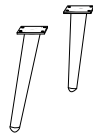
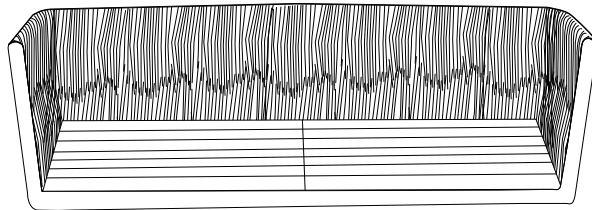

C x 4

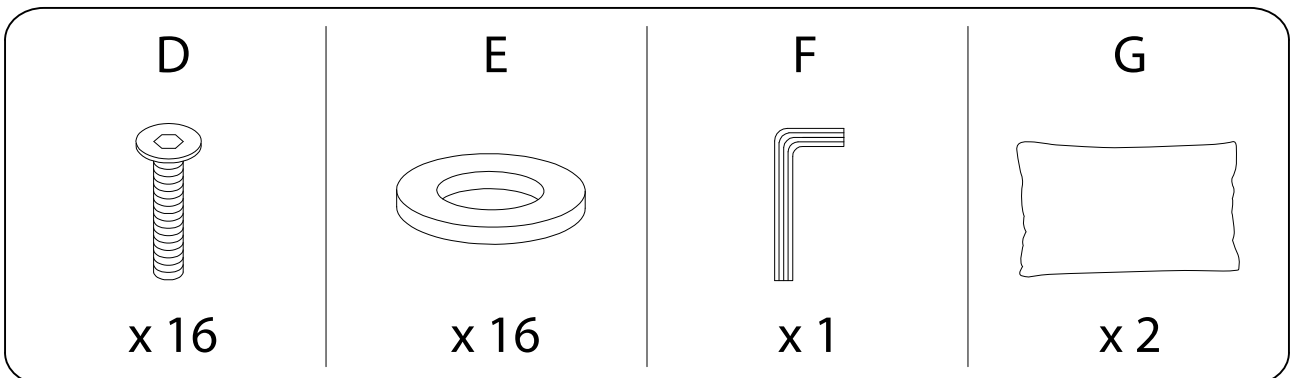
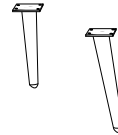

1

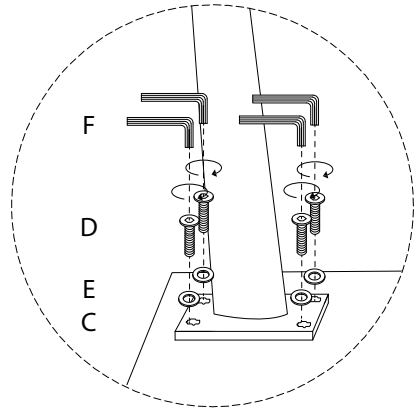
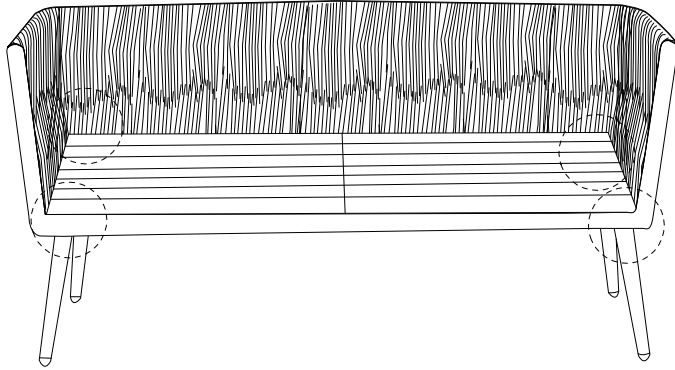
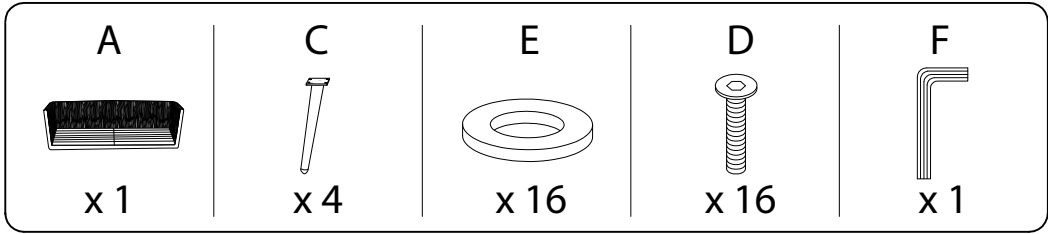

2

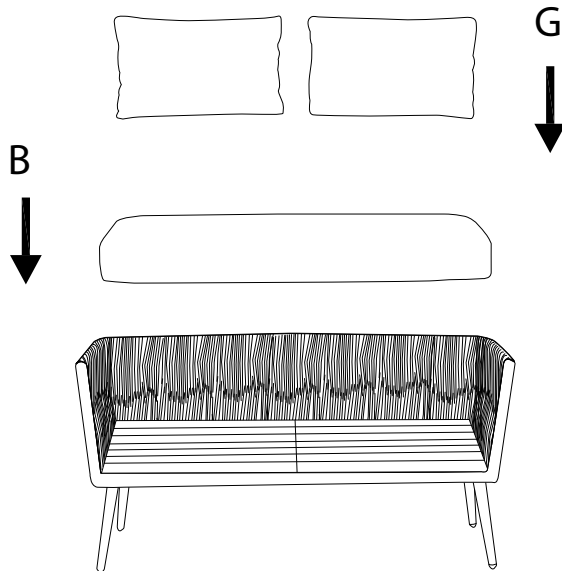
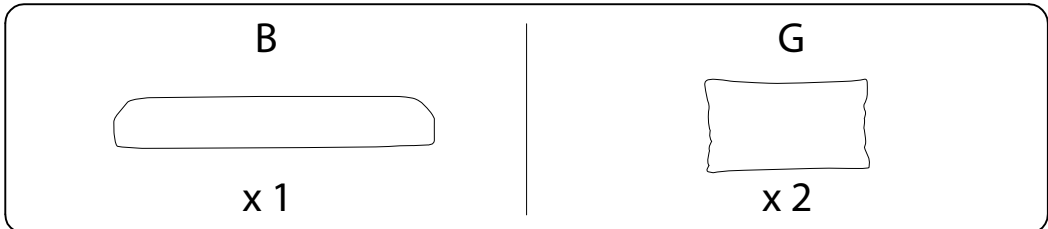

C

A

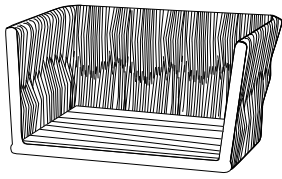

x 1

B



x 1

C



x 4

G

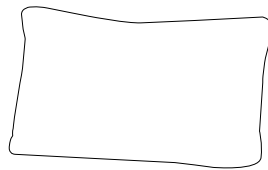

B



A

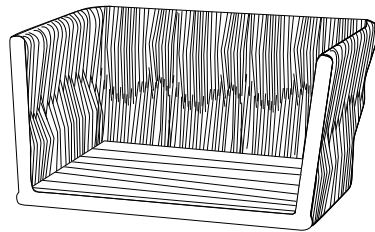

C x 4

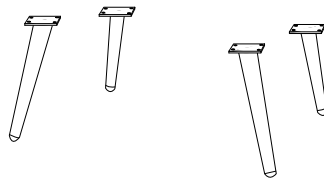

D

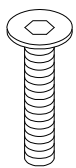

x 16

E

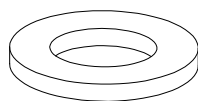

x 16

F

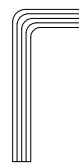

x 1

G

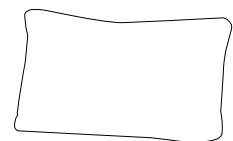

x 1

1

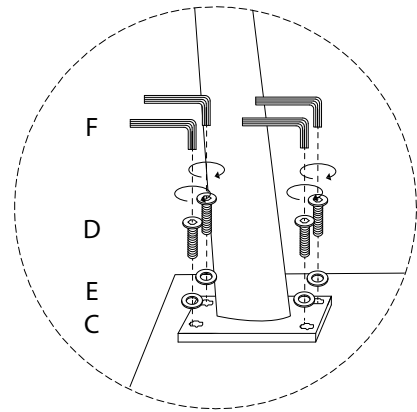
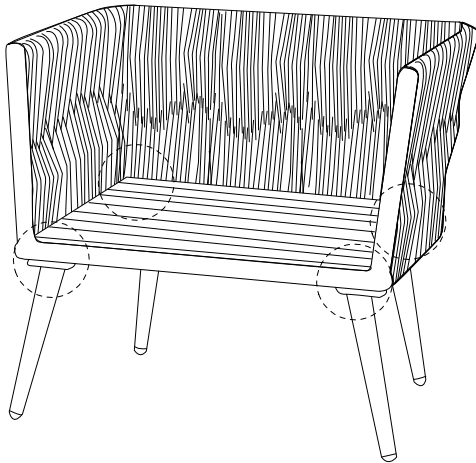
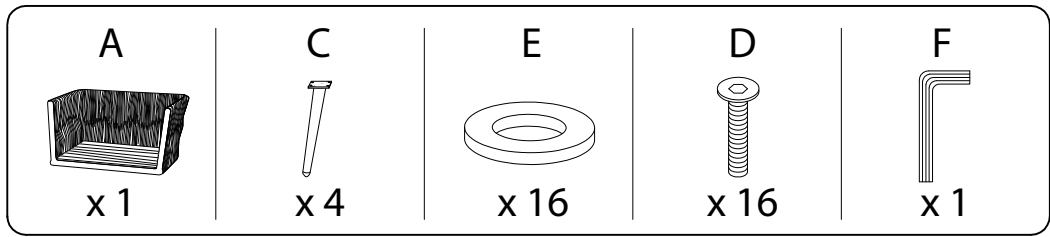

2

