



Assembly instructions for step 1/4:

- Warning:** Do not use a power drill. Use an L-shaped Allen key.
- Warning:** Do not use a screwdriver. Use a square block.





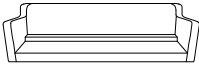

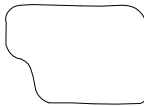
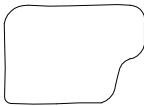
Estimated time: 30 minutes.

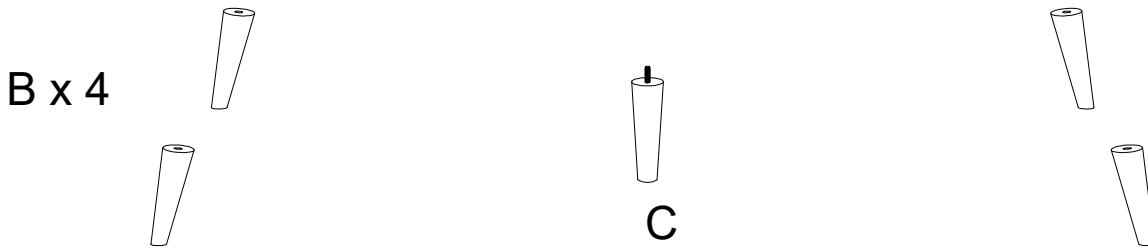
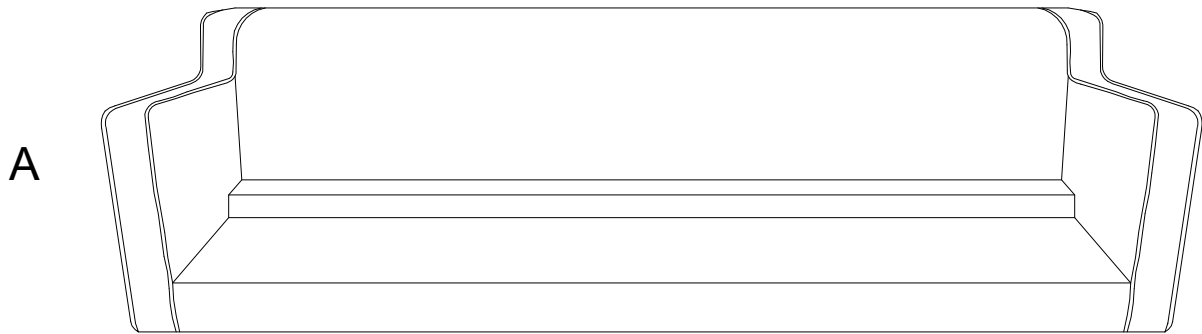
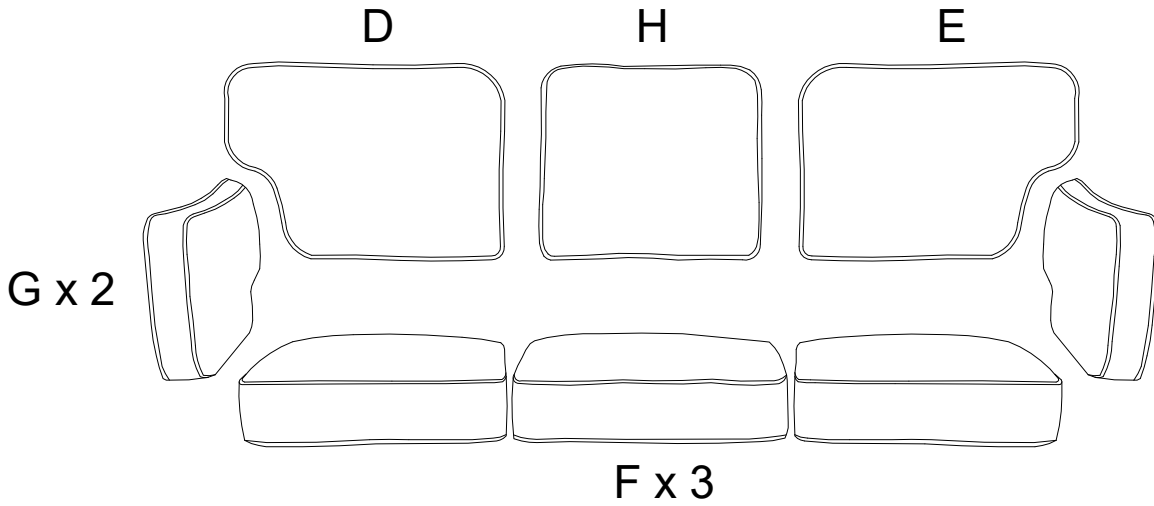
Number of people required: 1.

1/4

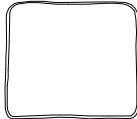
<b>A</b>	<b>B</b>	<b>C</b>	<b>D</b>	<b>E</b>
				
<b>x 1</b>	<b>x 4</b>	<b>x 1</b>	<b>x 1</b>	<b>x 1</b>





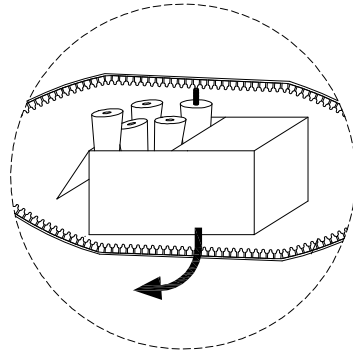
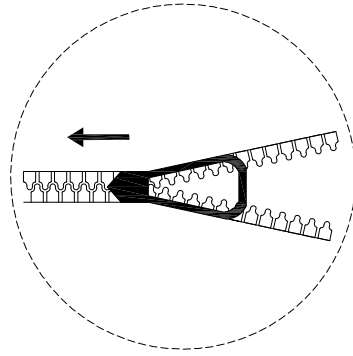
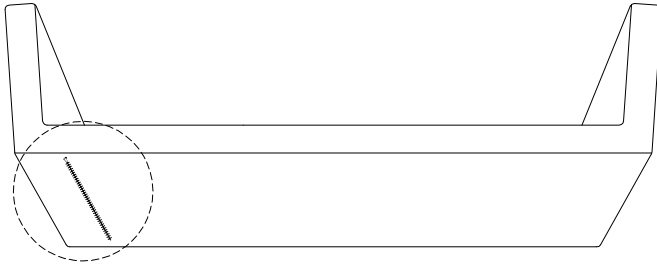

<b>F</b>	<b>G</b>	<b>H</b>	<b>I</b>	<b>J</b>	<b>K</b>
				 M8 x 65	
<b>x 3</b>	<b>x 2</b>	<b>x 1</b>	<b>x 1</b>	<b>x 4</b>	<b>x 4</b>

!

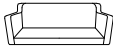

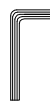

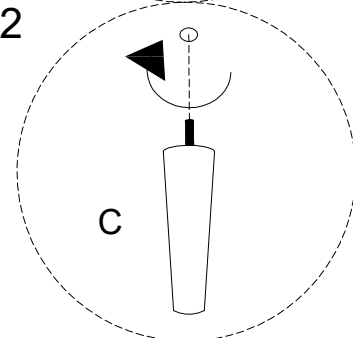
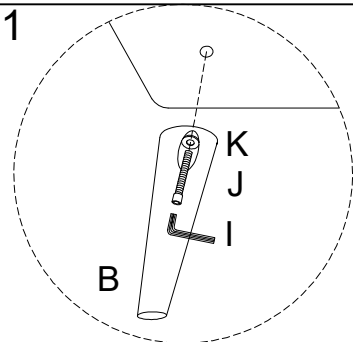
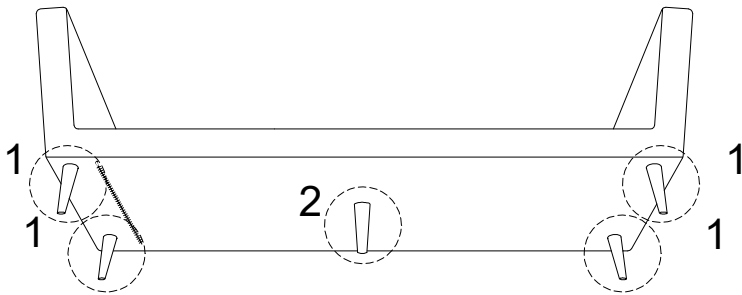

1

<b>A</b>  x 1	<b>B</b>  x 4	<b>C</b>  x 1	<b>I</b>  x 1	<b>J</b>  M8 x 65 x 4	<b>K</b>  x 4
--	--	--	---	---	--



2

D  x 1	E  x 1	F  x 3	G  x 2	H  x 1
---	---	---	---	---

