

# ALPHA1 L

Installation and operating instructions



**Original installation and operating instructions**

These installation and operating instructions describe Grundfos ALPHA1 L.

Sections 1-4 give the information necessary to be able to unpack, install and start up the product in a safe way.

Sections 5-12 give important information about the product, as well as information on service, fault finding and disposal of the product.

**CONTENTS**

	Page
<b>1. General information</b>	<b>2</b>
1.1 Hazard statements	2
1.2 Notes	2
<b>2. Receiving the product</b>	<b>3</b>
2.1 Inspecting the product	3
2.2 Scope of delivery	3
<b>3. Installing the product</b>	<b>3</b>
3.1 Mechanical installation	3
3.2 Pump positions	4
3.3 Control box positions	4
3.4 Electrical connection	5
3.5 Insulating the pump housing	6
<b>4. Starting up the product</b>	<b>7</b>
4.1 Before startup	7
4.2 Starting up the pump	7
4.3 Venting the pump	7
<b>5. Product introduction</b>	<b>8</b>
5.1 Product description	8
5.2 Applications	8
5.3 Pumped liquids	8
5.4 Identification	9
5.5 Accessories	10
<b>6. Control functions</b>	<b>12</b>
6.1 Operating panel	12
6.2 Control modes	12
6.3 Control signal	13
6.4 Pump performance	15
<b>7. Setting the product</b>	<b>16</b>
7.1 Setting the PWM input signal	17
<b>8. Servicing the product</b>	<b>17</b>
8.1 Dismantling the product	17
8.2 Dismantling the plug	17
<b>9. Fault finding the product</b>	<b>18</b>
9.1 Deblocking the shaft	19
<b>10. Technical data</b>	<b>20</b>
10.1 Dimensions, ALPHA1 L XX-40, XX-60, 15-65	21
10.2 Dimensions, ALPHA1 L 25-65	22
<b>11. Performance curves</b>	<b>22</b>
11.1 Guide to performance curves	22
11.2 Curve conditions	22
11.3 Performance curves, ALPHA1 L XX-40 (N)	23
11.4 Performance curves, ALPHA1 L XX-60 (N)	24
11.5 Performance curves, ALPHA1 L XX-65 (N)	25
<b>12. Disposal</b>	<b>25</b>



Read this document and the quick guide before you install the product. Installation and operation must comply with local regulations and accepted codes of good practice.



This appliance can be used by children aged from 8 years and above and persons with reduced physical, sensory or mental capabilities or lack of experience and knowledge if they have been given supervision or instruction concerning use of the appliance in a safe way and understand the hazards involved.

Children shall not play with the appliance. Cleaning and user maintenance shall not be made by children without supervision.

**1. General information****1.1 Hazard statements**

The symbols and hazard statements below may appear in Grundfos installation and operating instructions, safety instructions and service instructions.

**DANGER**

Indicates a hazardous situation which, if not avoided, will result in death or serious personal injury.

**WARNING**

Indicates a hazardous situation which, if not avoided, could result in death or serious personal injury.

**CAUTION**

Indicates a hazardous situation which, if not avoided, could result in minor or moderate personal injury.

The text accompanying the three hazard symbols DANGER, WARNING and CAUTION is structured in the following way:

**SIGNAL WORD****Description of hazard**

Consequence of ignoring the warning.  
- Action to avoid the hazard.

The hazard statements are structured in the following way:

**1.2 Notes**

The symbols and notes below may appear in Grundfos installation and operating instructions, safety instructions and service instructions.



Observe these instructions for explosion-proof products.



A blue or grey circle with a white graphical symbol indicates that an action must be taken.



A red or grey circle with a diagonal bar, possibly with a black graphical symbol, indicates that an action must not be taken or must be stopped.



If these instructions are not observed, it may result in malfunction or damage to the equipment.



Tips and advice that make the work easier.

## 2. Receiving the product

### 2.1 Inspecting the product

#### CAUTION

##### Crushing of feet

Minor or moderate personal injury

- Wear safety shoes when opening the box and handling the product.



Check that the product received is in accordance with the order.

Check that the voltage and frequency of the product match voltage and frequency of the installation site. See section [5.4.1 Nameplate](#).

### 2.2 Scope of delivery

The box contains the following items:

- ALPHA1 L pump
- installer plug
- two gaskets
- quick guide.

## 3. Installing the product

#### DANGER

##### Electric shock

Death or serious personal injury

- Switch off the power supply before starting any work on the product. Make sure that the power supply cannot be accidentally switched on.



#### CAUTION

##### Crushing of feet

Minor or moderate personal injury

- Wear safety shoes when opening the box and handling the product.



Installation must be carried out by trained persons in accordance with local regulations.



The pump must always be installed with a horizontal motor shaft within  $\pm 5^\circ$ .

## 3.1 Mechanical installation



The mechanical installation must be carried out by trained persons in accordance with local regulations.

### 3.1.1 Mounting the product

1. The arrows on the pump housing indicate the flow direction through the pump. See fig. 1.
2. Fit the two gaskets supplied with the pump when you mount the pump in the pipe. Install the pump with a horizontal motor shaft within  $\pm 5^\circ$ . See fig. 2. See also section [3.3 Control box positions](#).
3. Tighten the fittings. See fig. 3.



Fig. 1 Flow direction

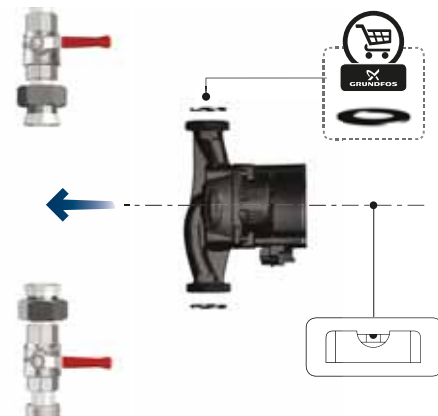

Fig. 2 Pump installation

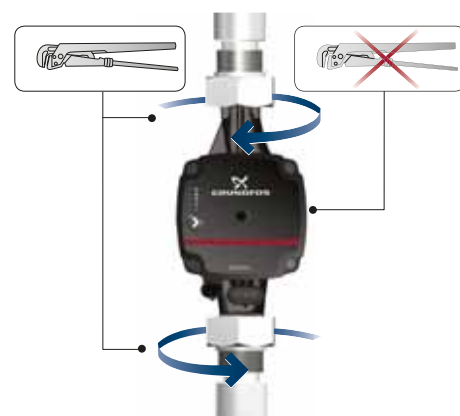

Fig. 3 Tightening the fittings

TM06 8535 0918

TM06 8536 0918

TM06 8537 0918

### 3.2 Pump positions

Always install the pump with a horizontal motor shaft within  $\pm 5^\circ$ . Do not install the pump with a vertical motor shaft. See fig. 4, bottom row.

- Pump installed correctly in a vertical pipe. See fig. 4, top row, left.
- Pump installed correctly in a horizontal pipe. See fig. 4, top row, right.

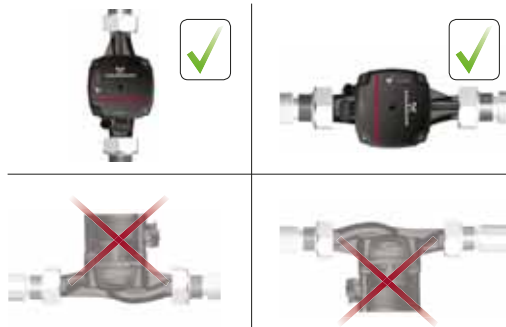

Fig. 4 Pump positions

### 3.3 Control box positions

**DANGER**

**Electric shock**



Death or serious personal injury  
- Switch off the power supply before starting any work on the product. Make sure that the power supply cannot be accidentally switched on.

**CAUTION**

**Hot surface**



Minor or moderate personal injury  
- The pump housing may be hot due to the pumped liquid being scalding hot. Close the isolating valves on both sides of the pump and wait for the pump housing to cool down.

**CAUTION**

**Pressurised system**



Minor or moderate personal injury  
- Before dismantling the pump, drain the system or close the isolating valves on both sides of the pump. The pumped liquid may be scalding hot and under high pressure.

The control box can be mounted in all positions. See fig. 5.

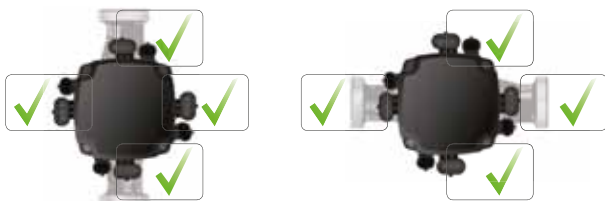

Fig. 5 Possible control box positions

### 3.3.1 Changing the control box position

Step	Action	Illustration
1	Make sure that the inlet and outlet valves are closed. Unscrew the screws on the pump head.	TM06 8539 0918
2	Turn the pump head to the desired position.	TM06 8540 0918
3	Refit the screws on the pump head.	TM06 8541 0918

### 3.4 Electrical connection



**DANGER**

**Electric shock**

Death or serious personal injury  
 - All electrical connections must be carried out by a qualified electrician in accordance with local regulations.



**DANGER**

**Electric shock**

Death or serious personal injury  
 - Switch off the power supply before starting any work on the product. Make sure that the power supply cannot be accidentally switched on.



**DANGER**

**Electric shock**

Death or serious personal injury  
 - Connect the pump to earth.



**DANGER**

**Electric shock**

Death or serious personal injury  
 - If national legislation requires a Residual-Current Device (RCD) or equivalent in the electrical installation, or if the pump is connected to an electric installation where an RCD is used as an additional protection, this must be type A or better, due to the nature of the pulsating DC leakage current. The RCD must be marked with the symbol shown below:



The pump is not a safety component and cannot be used to ensure functional safety in the final appliance.

- The motor requires no external motor protection.
- Check that the supply voltage and frequency correspond to the values stated on the nameplate. See section [5.4.1 Nameplate](#).
- Connect the pump to the power supply with the plug supplied with the pump. See steps 1 to 7.

### 3.4.1 Assembling the installer plug

Step	Action	Illustration
1	Loosen the cable gland and unscrew the union nut in the centre of the terminal cover.	
2	Detach the terminal cover.	
3	Pull the power cable through the cable gland and terminal cover.	
4	Strip the cable conductors as illustrated.	
5	Loosen the screws on the power supply plug and connect the cable conductors.	
6	Tighten the screws on the power supply plug.	

TM06 8542 0918

TM06 8543 0918

TM06 8544 0918

TM06 8545 0918

TM06 8546 0918 - TM06 8547 0918

TM06 8548 0918

Step	Action	Illustration
7	<p>Refit the terminal cover. See A.</p> <p>Note: It is possible to turn the power supply plug on the side for a 90 ° cable entry. See B.</p>	<p>A: A red terminal cover is being placed over a black power supply plug. B: The black power supply plug is being rotated 90 degrees clockwise.</p>
8	Tighten the union nut.	<p>A blue arrow points to the union nut on the side of the pump housing, indicating it should be tightened.</p>
9	Tighten the cable gland onto the power supply plug.	<p>A blue arrow points to the cable gland on the power supply plug, indicating it should be tightened.</p>
10	Insert the power supply plug into the male plug on the pump.	<p>A blue arrow points to the male plug on the pump housing, indicating where the power supply plug should be inserted.</p>

TM06 8549 0918 - TM06 8550 0918

TM06 8551 0918

TM06 8552 0918

TM06 8553 0119

### 3.5 Insulating the pump housing



TM06 8564 1317

**Fig. 6** Insulating the pump housing

You can reduce the heat loss from the pump and pipe by insulating the pump housing and the pipe with insulating shells, which can be ordered as an accessory. See section [5.5.2 Insulating shells](#).



Do not insulate the control box or cover the operating panel.



## 4. Starting up the product

### 4.1 Before startup

Do not start the pump until the system has been filled with liquid and vented. Make sure that the required minimum inlet pressure is available at the pump inlet. See section 10. *Technical data*.

When using the pump for the first time, the system must be vented. See section 4.3 *Venting the pump*. The pump is self-venting through the system.

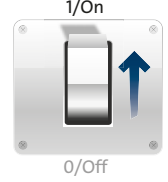
### 4.2 Starting up the pump

Step	Action	Illustration
1	Open the inlet and outlet valves.	
2	Switch on the power supply.	
3	The lights in the operating panel indicates that the power supply has been switched on and the pump is running.	

TM06 8554 0918

TM06 8555 1317

TM06 8556 0918

### 4.3 Venting the pump

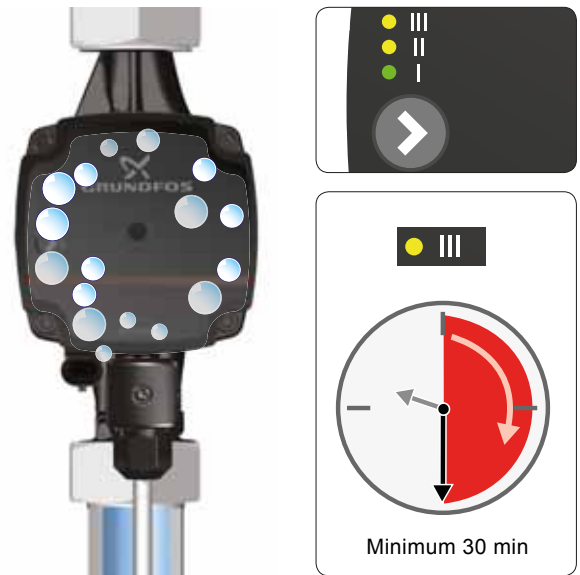

Fig. 7 Venting the pump

Small air pockets trapped inside the pump may cause noise when starting up the pump. However, because the pump is self-venting through the system, the noise ceases over a period of time.

To speed up the venting process, do as follows:

1. Set the pump to speed III using the button on the operating panel.
2. Let the pump run for minimum 30 minutes. How fast the pump is vented depends on the system size and design.

When you have vented the pump, that is when the noise has ceased, set the pump according to the recommendations. See section 6. *Control functions*.



The pump must not run dry.



The pump is from factory set to radiator heating mode.

TM07 0153 0918

## 5. Product introduction

### 5.1 Product description

ALPHA1 L can be used as stand-alone or integrated circulator pump in existing systems as replacement or in new systems with either variable or constant flow rate.

#### 5.1.1 Model type

These installation and operating instructions cover ALPHA1 L. The model type is stated on the packaging and nameplate.

### 5.2 Applications

The pump is designed for circulating liquids in all kinds of heating applications. The pumps are suitable for the following systems:

- Systems with constant or variable flows where it is desirable to optimise the pump duty point.
- Installation in existing systems where the differential pressure of the pump is too high during periods of reduced flow demand.
- Installation in new systems for automatic adjustment of the performance to flow demands without the use of bypass valves or similar expensive components.

The speed can be controlled by a low-voltage PWM (Pulse Width Modulation) signal.

High-efficiency ECM (Electronically Commutated Motor) pumps, such as ALPHA1 L, must not be speed-controlled by an external speed controller varying or pulsing the supply voltage.

### 5.3 Pumped liquids

In heating systems, the water must meet the requirements of accepted standards on water quality in heating systems, for example the German guideline VDI 2035.

The pump is suitable for clean, thin, non-aggressive and non-explosive liquids, not containing solid particles, fibres or mineral oil.

- Maximum water/propylene glycol mixture is 50 %
- Maximum 10 mm<sup>2</sup>/s viscosity

Note: The water/propylene glycol mixture reduces the performance due to higher viscosity.

See section [10. Technical data](#) for further information.



In domestic hot-water systems, we recommend that you keep the liquid temperature below 65 °C to eliminate the risk of lime precipitation.

#### CAUTION

##### Flammable material

Minor or moderate personal injury  
- Do not use the pump for flammable liquids, such as diesel oil and petrol.



#### CAUTION

##### Corrosive substance

Minor or moderate personal injury  
- Do not use the pump for aggressive liquids, such as acids and seawater.





## 5.4 Identification

### 5.4.1 Nameplate

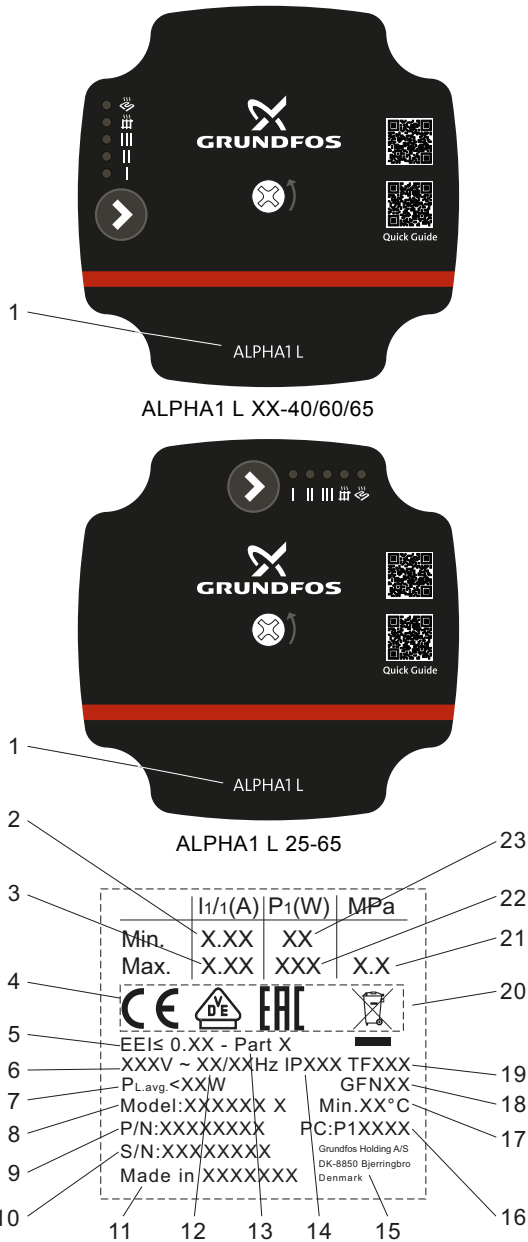

Fig. 8 Nameplate

Pos.	Description
1	Pump name
2	Minimum current [A]
3	Maximum current [A]
4	CE mark and approvals
5	Energy Efficiency Index, EEI
6	Voltage [V]
7	Average compensated power input PL, avg [W]
8	Product type
9	Material number
10	Serial number
11	Country of origin
12	Frequency [Hz]
13	Part, according to EEI
14	Enclosure class
15	Manufacturer's name and address
16	Production code: • 1st and 2nd figures: production site code • 3rd and 4th figures: year • 5th and 6th figures: week
17	Minimum liquid temperature
18	VDE code
19	TF class
20	Crossed-out wheeled bin according to EN 50419
21	Maximum system pressure
22	Maximum input power [W]
23	Minimum input power [W]

### 5.4.2 Type key

Example	ALPHA1 L 25 -40	180
Pump type		
Nominal diameter (DN) of inlet and outlet ports [mm]		
Maximum head [dm]		
[ ]: Cast-iron pump housing N: Stainless-steel pump housing		
Port-to-port length [mm]		

TM06 8664 1717

## 5.5 Accessories

### 5.5.1 Unions and valve kits

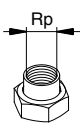
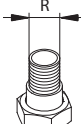
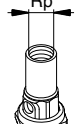
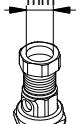
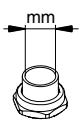
		Product numbers, unions														
ALPHAX	Connection															
		3/4	1	1 1/4	1	1 1/4	3/4	1	1 1/4	Ø22	Ø28	Ø15	Ø18	Ø22	Ø28	Ø42
25-xx	G 1 1/2	529921	529922	529821	529925	529924										
25-xx N		529971	529972				519805	519806	519807	519808	519809			529977	529978	529979
32-xx	G 2		509921	509922												

G-threads have a cylindrical form in accordance with the EN ISO 228-1 standard and are not sealing the thread. It requires a flat gasket. You can only screw cylindrical male G-threads, into female G-threads. The G-threads are standard thread on the pump housing.

R-threads are tapered external threads in accordance with the EN 10226-1 standard.

Rc- or Rp-threads are internal threads with either tapered or cylindrical threads. You can screw conical male R-threads into female Rc- or Rp-threads. See fig. 9.

### 5.5.2 Insulating shells

The insulating shells, which are tailored to the individual pump type, can be ordered as accessories. It is easy to fit the insulating shells around the pump.

Pump type	Product number
ALPHA1 L XX-XX (N)	99270706

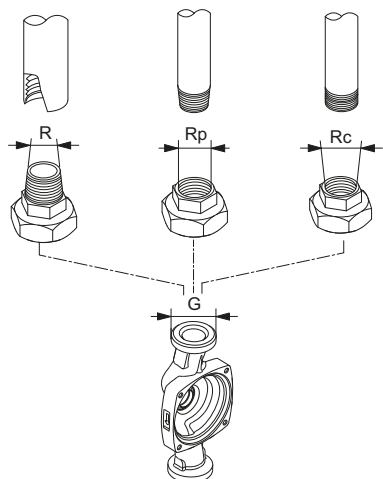

TM06 7632 3616

Fig. 9 G-threads and R-threads

### 5.5.3 Cables and plugs

The pump has two electrical connections: the power supply and the control signal connection.

#### Power supply connection

The installer plug is both supplied with the pump and available as an accessory.

Power cable adapters are also available as accessories.





#### Control signal connection

The control signal cable connection has three conductors: the signal input, the signal output and the signal reference. Connect the cable to the control box by a mini superseal plug. See section [7.1 Setting the PWM input signal](#). The optional signal cable is available as an accessory.



TM06 58210216

Fig. 10 Mini superseal plug

Product	Product description	Length [mm]	Product number
	Installer plug		99439948
	Mini superseal signal cable (PWM input signal)	2000	99165309
	Superseal power cable	2000	99198990
	Power cable adapter: Superseal Molex cable adapter, overmoulded	150	99165311
	Power cable adapter: Superseal Volex cable adapter, overmoulded	150	99165312

## 6. Control functions

### 6.1 Operating panel



Fig. 11 Operating panel

Symbol	Description
	Button
I, II, III	Constant curve or constant speed curve I, II and III
	Radiator heating mode (proportional pressure)
	Underfloor heating mode (constant pressure)

The operating panel shows the following:

- The control mode, after pressing the button
- Alarm status

#### 6.1.1 Alarm or warning

If the pump has detected one or more alarms or warnings, the first LED switches from green to red. When the fault has been resolved the operating panel switches back to operating status. See section 9. [Fault finding the product](#).

## 6.2 Control modes

The pump has seven different control modes. Learn more about them in the following sections.

### 6.2.1 Radiator heating mode (factory setting)

The radiator heating mode adjusts the pumps performance to the actual heat demand in the system following a proportional-pressure curve.

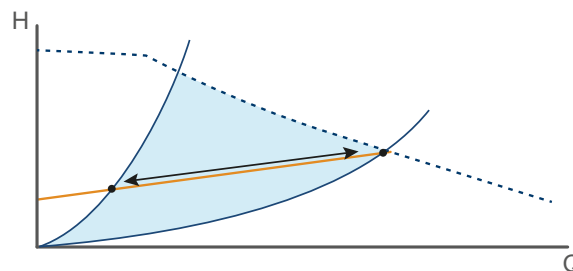

Fig. 12 Proportional-pressure curve

System type	Recommended control mode	Alternative control mode
Two-pipe system	Radiator heating mode	Constant curve or constant speed I, II, III, see section <a href="#">6.2.3 Constant curve or constant speed, I, II or III</a>

### 6.2.2 Underfloor heating mode

The underfloor heating mode adjusts the pump performance to the actual heat demand in the system following a constant-pressure curve.

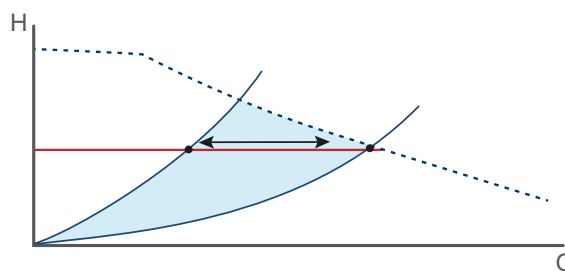
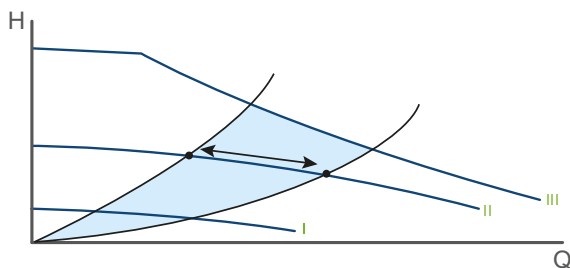

Fig. 13 Constant-pressure curve

System type	Recommended control mode	Alternative control mode
Underfloor heating system	Underfloor heating mode	No alternatives

### 6.2.3 Constant curve or constant speed, I, II or III

At constant-curve or constant-speed operation, the pump runs at a constant curve. The pump performance follows the selected performance curve, I, II or III. See fig. 14 where II has been selected.



TM06 8822 1217

Fig. 14 Constant-curve/-speed curve

The selection of the constant-curve or constant-speed setting depends on the characteristics of the heating system in question.

### 6.2.4 Pump setting for one-pipe heating systems

Recommended and alternative pump settings:

System type	Recommended control mode	Alternative control mode
One-pipe heating system	Constant curve or constant speed, I, II or III. See section 6.2.3 <i>Constant curve or constant speed, I, II or III.</i>	No alternatives

### 6.2.5 Pump setting for domestic hot-water systems

Recommended and alternative pump settings:

System type	Recommended control mode	Alternative control mode
Domestic hot-water system	Constant curve or constant speed, I, II or III. See section 6.2.3 <i>Constant curve or constant speed, I, II or III.</i>	No alternatives

### 6.2.6 Changing from recommended to alternative pump setting

Heating systems are relatively slow systems that cannot be set to the optimum operation within minutes or hours.

If the recommended pump setting does not give the desired distribution of heat in the rooms of the house, change the pump setting to the shown alternative.

### 6.3 Control signal

The pump can be controlled via a digital low-voltage pulse-width modulation (PWM) signal.

The square-wave PWM signal is designed for a 100 to 4,000 Hz frequency range. The PWM signal is used to select the speed (speed command) and as feedback signal. The PWM frequency on the feedback signal is fixed at 75 Hz in the pump.

For instructions on how to set the connection, see section 7.1 *Setting the PWM input signal.*

#### Duty cycle

$$d \% = 100 \times t/T$$

Example	Rating
T = 2 ms (500 Hz)	$U_{iH} = 4-24 \text{ V}$
t = 0.6 ms	$U_{iL} \leq 1 \text{ V}$
$d \% = 100 \times 0.6 / 2 = 30 \%$	$I_{iH} \leq 10 \text{ mA}$ (depending on $U_{iH}$ )

#### Example

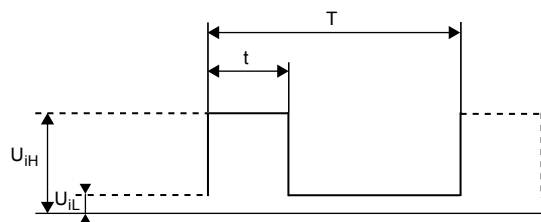

TM04 9911 0211

Fig. 15 PWM signal

Abbreviation	Description
T	Period of time [sec.]
d	Duty cycle [t/T]
$U_{iH}$	High-level input voltage
$U_{iL}$	Low-level input voltage
$I_{iH}$	High-level input current

#### 6.3.1 Interface

The pump's interface consists of an electronic part connecting the external control signal to the pump. The interface translates the external signal into a signal type that the microprocessor can understand.

In addition, the interface ensures that the user cannot get into contact with dangerous voltage if touching the signal wires when power is connected to the pump.

**Note:** "Signal ref." is a signal reference with no connection to protective earth.

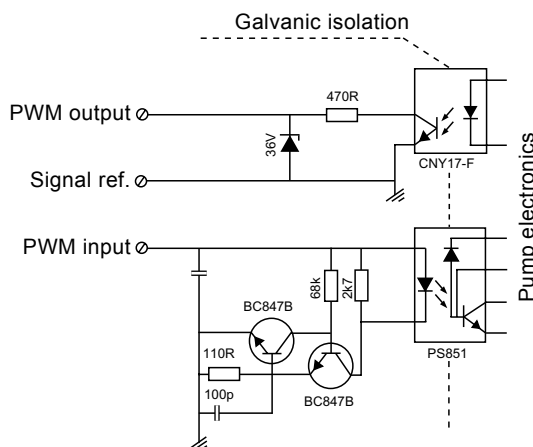

TM06 0787 0914

Fig. 16 Schematic drawing, interface

**6.3.2 PWM input signal profile A (heating)**

The pump runs on constant-speed curves depending on the PWM input signal. The speed decreases when the PWM value increases. If PWM equals 0, the pump runs at maximum speed.

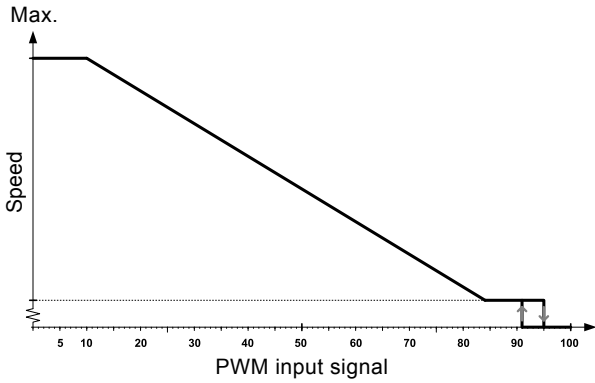

TM06 9136 1617

**Fig. 17** PWM input signal profile A (heating)

PWM input signal [%]	Pump status
≤ 10	Maximum speed: max.
> 10 / ≤ 84	Variable speed: min. to max.
> 84 / ≤ 91	Minimum speed: IN
> 91/95	Hysteresis area: on/off
> 95 or ≤ 100	Standby mode: off

**6.3.3 PWM feedback signal**

The PWM feedback signal offers pump information like in bus systems:

- current power consumption (accuracy ± 2 % of PWM signal)
- warning
- alarm.

**Alarms**

Alarm output signals are available because some PWM output signals are dedicated to alarm information. If a supply voltage is measured below the specified supply voltage range, the output signal is set to 75 %. If the rotor is locked due to deposits in the hydraulics, the output signal is set to 90 % because this alarm has a higher priority. See fig. 18.

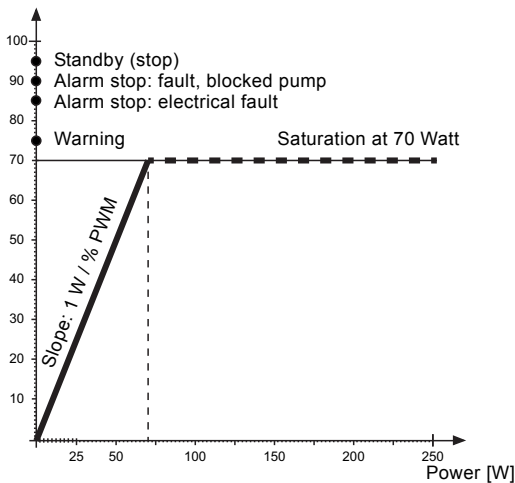

TM07 1313 1118

**Fig. 18** PWM feedback signal - power consumption

**Data**

Maximum rating	Symbol	Value
PWM frequency input with high-speed optocoupler	f	100-4000 Hz
Guaranteed standby power consumption		< 1 W
Rated input voltage - high level	U <sub>iH</sub>	4-24 V
Rated input voltage - low level	U <sub>iL</sub>	< 1 V
High-level input current	I <sub>iH</sub>	< 10 mA
Input duty cycle	PWM	0-100 %
PWM frequency output, open collector	f	75 Hz ± 5 %
Accuracy of output signal regarding power consumption	-	± 2 % (of PWM signal)
Output duty cycle	PWM	0-100 %
Collector emitter breakdown voltage on output transistor	U <sub>c</sub>	< 70 V
Collector current on output transistor	I <sub>c</sub>	< 50 mA
Maximum power dissipation on output resistor	P <sub>R</sub>	125 mW
Zener diode working voltage	U <sub>z</sub>	36 V
Maximum power dissipation in Zener diode	P <sub>z</sub>	300 mW

### 6.4 Pump performance

Figure 19 shows the relation between pump setting and pump performance by means of curves.

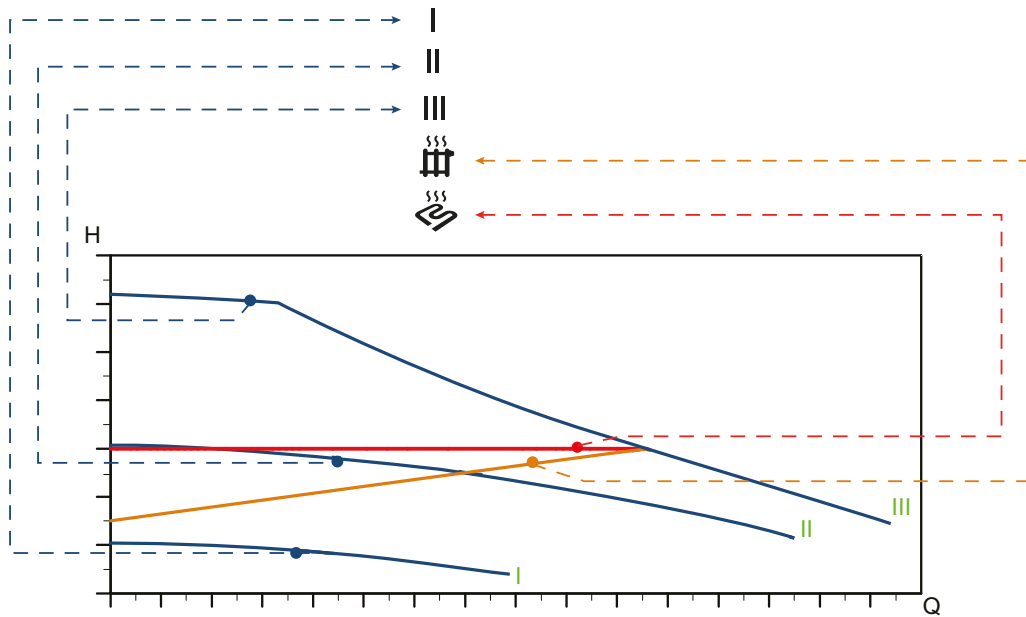



Fig. 19 Pump setting in relation to pump performance

TM06 8818 1217

Setting	Pump curve	Function
I	Constant curve or constant speed I	The pump runs at a constant speed and consequently on a constant curve. At speed I, the pump is set to run on the minimum curve under all operating conditions.
II	Constant curve or constant speed II	The pump runs at a constant speed and consequently on a constant curve. At speed II, the pump is set to run on the intermediate curve under all operating conditions.
III	Constant curve or constant speed III	The pump runs at a constant speed and consequently on a constant curve. At speed III, the pump is set to run on the maximum curve under all operating conditions. Quick venting of the pump can be obtained by setting the pump to speed III for a short period.
	Radiator heating mode (proportional-pressure curve)	The duty point of the pump will move up or down on a proportional-pressure curve, depending on the heat demand in the system. The head (pressure) is reduced at falling heat demand and increased at rising heat demand.
	Underfloor heating mode (constant-pressure curve)	The duty point of the pump will move out or in on a constant-pressure curve, depending on the heat demand in the system. The head (pressure) is kept constant, irrespective of the heat demand.

## 7. Setting the product

To set the product use the button on the operating panel. Every time you press the button, the pump setting is changed. The LEDs will indicate the chosen control mode. See fig. 20. A cycle is five button presses.

The pump automatically enables the PWM input-signal control mode when the signal cable is plugged in and the PWM signal is detected by the pump. For details on setting the PWM input signal, see section [7.1 Setting the PWM input signal](#).

To select the fixed proportional-pressure curve, press and hold the button for 3 seconds. To disable this control mode, press and hold the button for 3 seconds.

To learn more about each control mode, see section [6.2 Control modes](#).

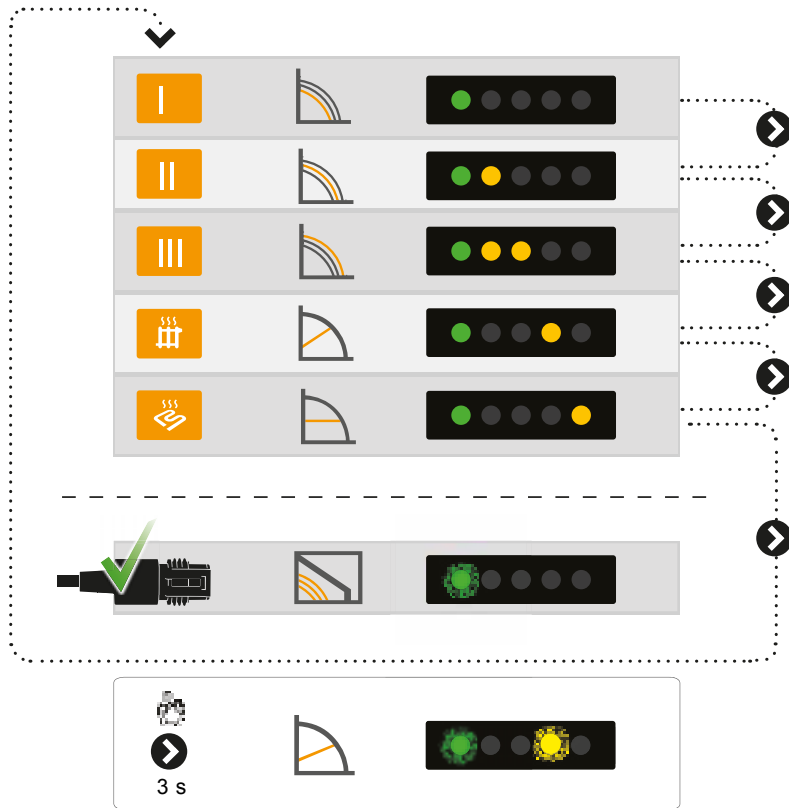

Fig. 20 Operating panel LEDs indicating the different control modes



The pump has been factory-set to radiator heating mode.



## 7.1 Setting the PWM input signal

To enable the external control mode (PWM profile A), you need a signal cable connected to an external system. The cable connection has three conductors: the signal input, the signal output and the signal reference.

The cable is not supplied with the pump but can be ordered as an accessory.



The cable must be connected to the control box via a mini superseal plug. See fig. 21.



Fig. 21 Mini superseal plug

### Set the signal connection

1. Make sure that the pump is turned off.
2. Locate the PWM signal connection on the pump. The three pins inside the signal connection are not energised. Connect the signal cable with the mini superseal plug.
3. Switch on the power supply.
4. The pump automatically detects if a valid PWM signal is available after which it enables the control mode on the pump. See fig. 22.



1 x 230 V -15 %/+ 10 %  
~ 50/60 Hz Ⓢ



Fig. 22 Connecting the signal cable to ALPHA1 L

TM06 5821 0216

TM06 7633 0918

## 8. Servicing the product

### DANGER

#### Electric shock

Death or serious personal injury  
- All electrical connections must be carried out by a qualified electrician in accordance with local regulations.



### DANGER

#### Electric shock

Death or serious personal injury  
- Switch off the power supply before starting any work on the product. Make sure that the power supply cannot be accidentally switched on.



### CAUTION

#### Hot surface

Minor or moderate personal injury  
- The pump housing may be hot due to the pumped liquid being scalding hot. Close the isolating valves on both sides of the pump and wait for the pump housing to cool down.



### CAUTION

#### Pressurised system

Minor or moderate personal injury  
- Before dismantling the pump, drain the system or close the isolating valves on both sides of the pump. The pumped liquid may be scalding hot and under high pressure.



All service must be carried out by an instructed service technician.

### 8.1 Dismantling the product

1. Switch off the power supply.
2. Pull out the plug. For instructions on how to dismantle the plug, see section 8.2 *Dismantling the plug*.
3. Close the two isolating valves on both sides of the pump.
4. Loosen the fittings.
5. Remove the pump from the system.

### 8.2 Dismantling the plug

1. Loosen the cable gland and unscrew the union nut in the centre of the terminal cover.
2. Detach the terminal cover.
3. Loosen the screws on the power supply plug and disconnect the cable conductors.
4. Pull the power cable back through the cable gland and terminal cover.

## 9. Fault finding the product

If the pump has detected one or more alarms, the first LED switches from green to red. When an alarm is active, the LEDs indicate the alarm type as defined in fig. 23.



If multiple alarms are active at the same time, the LEDs only show the error with the highest priority. The priority is defined by the sequence of the table.

When there is no active alarm anymore, the operating panel switches back to operating status and the first LED switches from red to green.

### DANGER

#### Electric shock

- Death or serious personal injury
- Switch off the power supply before starting any work on the product. Make sure that the power supply cannot be accidentally switched on.



### CAUTION

#### Hot surface

- Minor or moderate personal injury
- The pump housing may be hot due to the pumped liquid being scalding hot. Close the isolating valves on both sides of the pump and wait for the pump housing to cool down.



### CAUTION

#### Pressurised system

- Minor or moderate personal injury
- Before dismantling the pump, drain the system or close the isolating valves on both sides of the pump. The pumped liquid may be scalding hot and under high pressure.



Status	Fault	Display	Solution
<p><b>Alarm</b> The pump stops. The pump is blocked.</p>			<p>Deblock the shaft. See section <a href="#">9.1 Deblocking the shaft</a>.</p>
<p><b>Warning</b> The pump keeps running. The supply voltage is low.</p>			<p>Make sure that there is sufficient voltage supply to the pump.</p>
<p><b>Alarm</b> The pump stops. Electrical error.</p>			<p>Replace the pump and send the pump to the nearest Grundfos Service Center.</p>

Fig. 23 Fault finding table

### 9.1 Deblocking the shaft

If the pump is blocked it is necessary to deblock the shaft. The pump deblocking device is accessible from the front of the pump without having to demount the control box. The force of the device is high enough to deblock pumps, which are seized by lime, for example if the pump has been turned off during summer.

#### Course of action:

1. Switch off the power supply.
2. Close the valves.
3. Locate the deblocking screw in the centre of the control box. Use a star screwdriver with a size 2 Phillips tip to push the deblocking screw inwards.
4. When the screw can be turned counterclockwise, the shaft has been deblocked. Repeat step 3, if necessary.
5. Switch on the power supply.

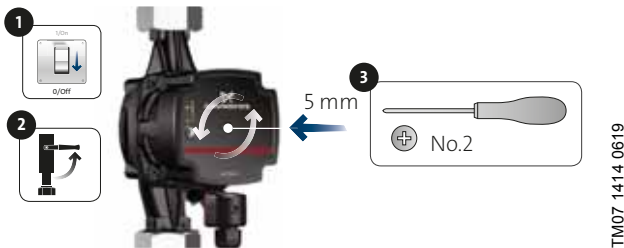

Fig. 24 Deblocking the shaft



Before, during and after the deblocking, the device is tight and must not release any water.

## 10. Technical data

Operating conditions		
Sound pressure level	The sound pressure level of the pump is lower than 43 dB(A).	
Relative humidity	Maximum 95 %, non-condensing environment	
System pressure	PN 10: Maximum 1.0 MPa (10 bar)	
Inlet pressure	<b>Liquid temperature</b>	<b>Minimum inlet pressure</b>
	75 °C	0.005 MPa (0.05 bar), 0.5 m head
	95 °C	0.05 MPa (0.5 bar), 5 m head
Ambient temperature	0-55 °C	
Liquid temperature	2-95 °C	
Liquid	Maximum water/propylene glycol mixture is 50 %	
Viscosity	Maximum 10 mm <sup>2</sup> /s	
Minimum switching time power on/off	No specific requirements.	
Maximum altitude of installation	2000 m above sea level	
Electrical data		
Supply voltage	1 x 230 V - 15 %/+ 10 %, 50/60 Hz, PE	
Insulation class	F	
Standby power consumption	< 0.3 W	
Miscellaneous data		
Motor protection	The pump requires no external motor protection.	
Enclosure class	IPX4D	
Temperature class (TF)	TF95	
Specific EEI values	ALPHA1 L XX-40: EEI ≤ 0.20	
	ALPHA1 L XX-60: EEI ≤ 0.20	
	ALPHA1 L XX-65: EEI ≤ 0.20	

To avoid condensation in the stator, the liquid temperature must always be higher than the ambient temperature.



In domestic hot-water systems, we recommend that you keep the liquid temperature below 65 °C to eliminate the risk of lime precipitation.

## 10.1 Dimensions, ALPHA1 L XX-40, XX-60, 15-65

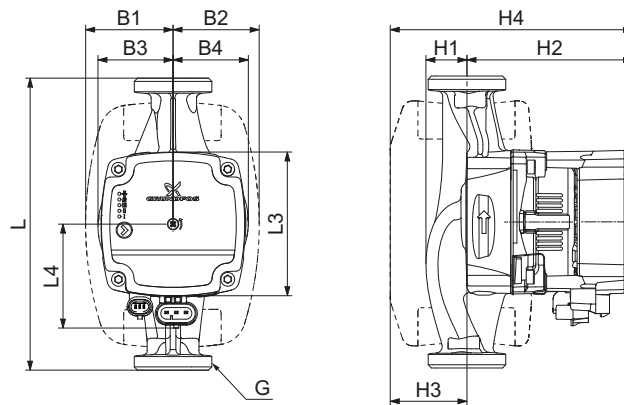

Fig. 25 ALPHA1 L XX-40, XX-60, 15-65

TM07 1242 1218

Pump type	Dimensions [mm]											
	L	L3	L4	B1	B2	B3	B4	H1	H2	H3	H4	G
ALPHA1 L 15-40	130	88	64	54	54	46	47	25	102	47	149	G 1
ALPHA1 L 15-60	130	88	64	54	54	46	47	25	102	47	149	G 1
ALPHA1 L 15-65	130	88	64	54	54	46	47	25	102	47	149	G 1
ALPHA1 L 20-40	130	88	64	54	54	46	47	25	102	47	149	G 1 1/4
ALPHA1 L 20-40 N	150	90	64	54	54	49	49	27	102	47	149	G 1 1/4
ALPHA1 L 20-60	130	88	64	54	54	46	47	25	102	47	149	G 1 1/4
ALPHA1 L 20-60 N	150	90	64	54	54	49	49	27	102	47	149	G 1 1/4
ALPHA1 L 25-40	130	88	64	54	54	46	47	25	102	47	149	G 1 1/2
ALPHA1 L 25-40	180	88	64	54	54	46	46	25	102	47	149	G 1 1/2
ALPHA1 L 25-40 N	180	90	64	54	54	49	49	27	102	47	149	G 1 1/2
ALPHA1 L 25-60	130	88	64	54	54	46	47	25	102	47	149	G 1 1/2
ALPHA1 L 25-60	180	88	64	54	54	46	46	25	102	47	149	G 1 1/2
ALPHA1 L 25-60 N	180	90	64	54	54	49	49	27	102	47	149	G 1 1/2
ALPHA1 L 32-40	180	88	64	54	54	46	48	26	102	47	149	G 2
ALPHA1 L 32-60	180	88	64	54	54	46	48	26	102	47	149	G 2

## 10.2 Dimensions, ALPHA1 L 25-65

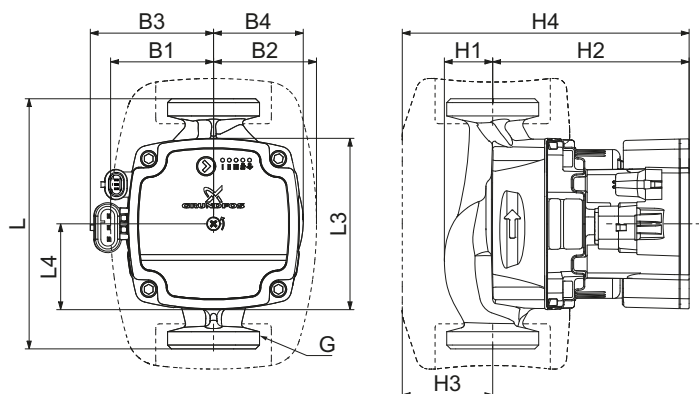

Fig. 26 ALPHA1 L 25-65

TM07 1316 1218

Pump type	Dimensions [mm]											
	L	L3	L4	B1	B2	B3	B4	H1	H2	H3	H4	G
ALPHA1 L 25-65	130	89	45	54	54	72	47	25	102	47	149	G 1 1/2

## 11. Performance curves

### 11.1 Guide to performance curves

Each pump has its own performance curve.

A power curve, P1, belongs to each performance curve. The power curve shows the pump power consumption in watt at a given performance.

### 11.2 Curve conditions

The guidelines below apply to the performance curves on the following pages:

- Test liquid: airless water.
- The curves apply to a density of  $\rho = 983.2 \text{ kg/m}^3$  and a liquid temperature of  $60 \text{ }^\circ\text{C}$ .
- All curves show average values and must not be used as guarantee curves. If a specific minimum performance is required, individual measurements must be made.
- The curves for speeds I, II and III are marked.
- The curves apply to a kinematic viscosity of  $\nu = 0.474 \text{ mm}^2/\text{s}$  (0.474 cSt).
- The EEI values obtained according to EN 16297 part 3.

11.3 Performance curves, ALPHA1 L XX-40 (N)

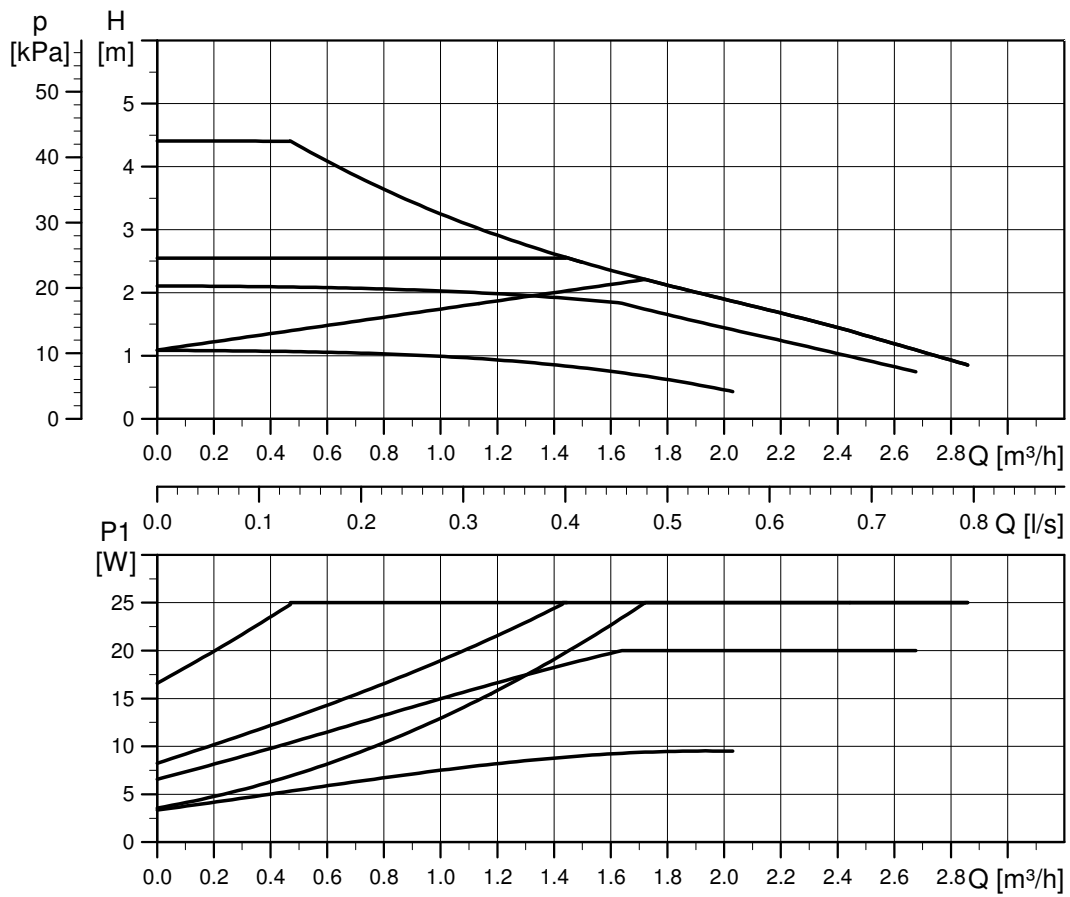

Fig. 27 ALPHA1 L XX-40

Setting	P1 [W]	I <sub>1</sub> [A]
Min.	4	0.05
Max.	25	0.26

TM07 0797 1018

11.4 Performance curves, ALPHA1 L XX-60 (N)

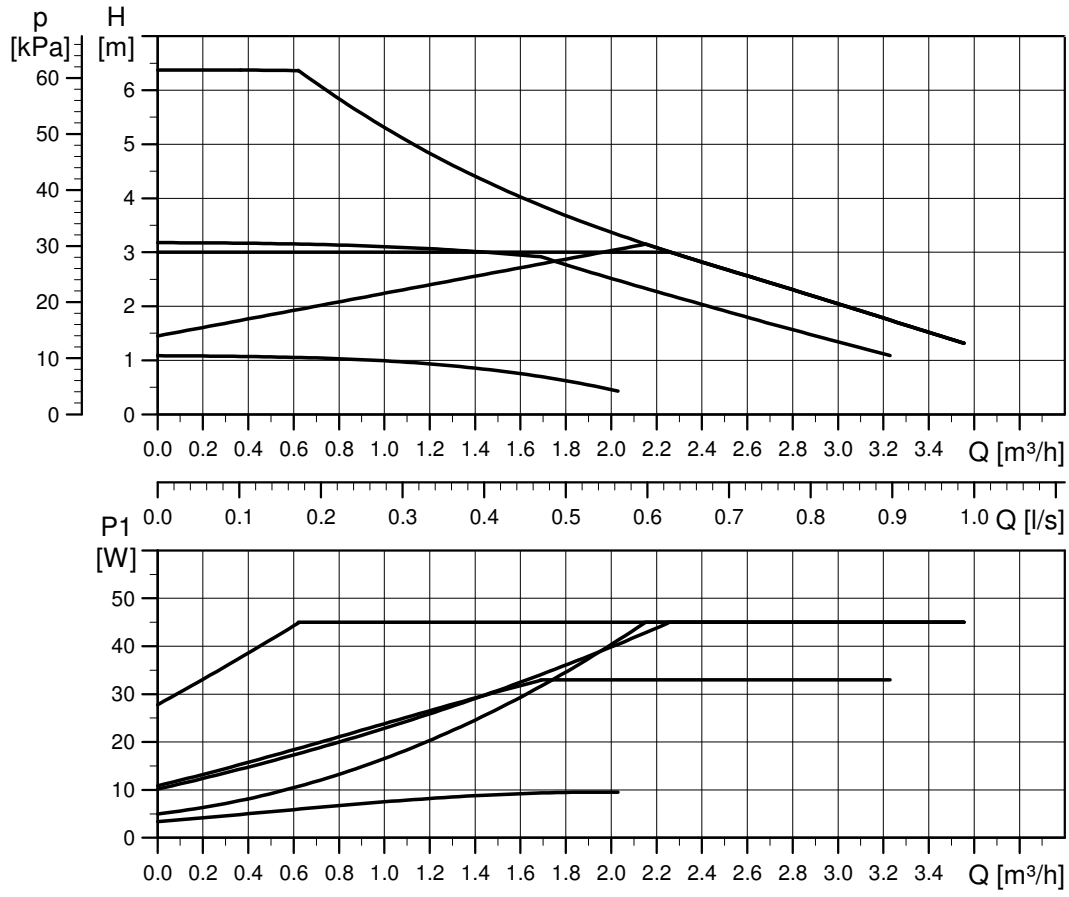

Fig. 28 ALPHA1 L XX-60

Setting	P1 [W]	I <sub>1</sub> [A]
Min.	4	0.05
Max.	45	0.42

TM07 0798 1018



11.5 Performance curves, ALPHA1 L XX-65 (N)

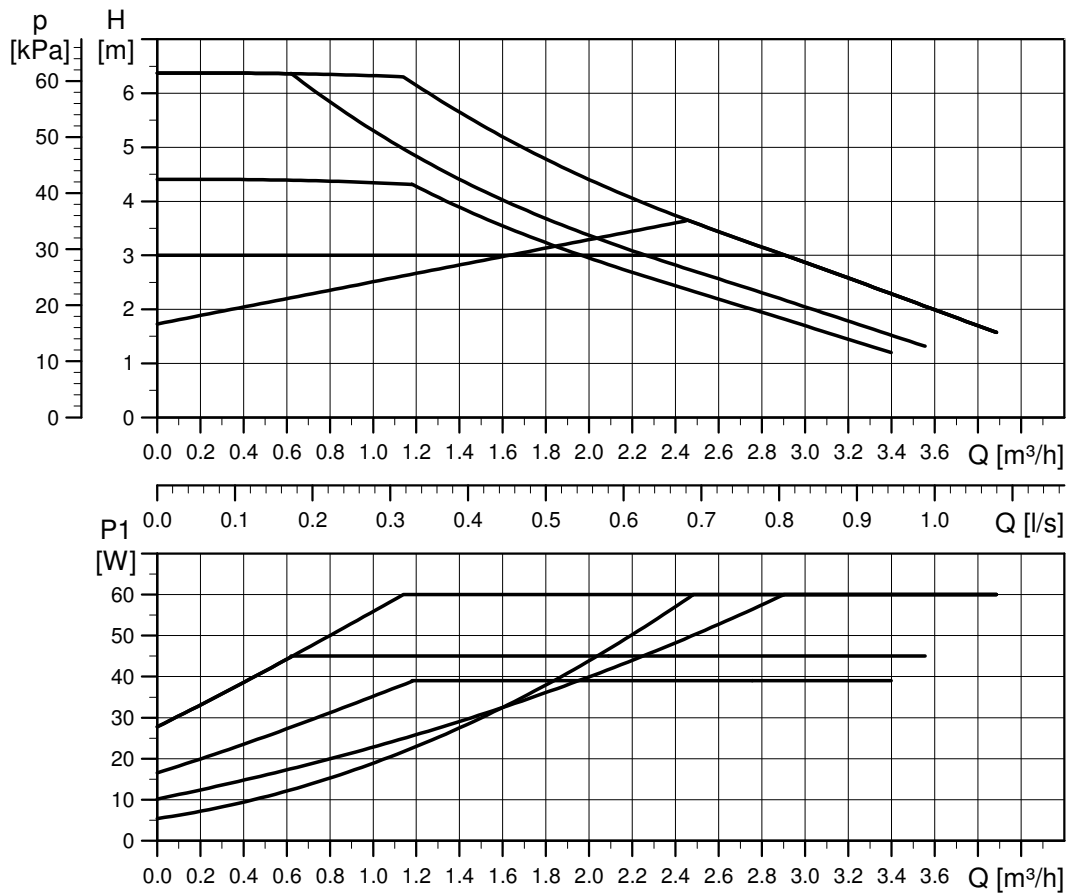

Fig. 29 ALPHA1 L XX-65

Setting	P1 [W]	I <sub>1</sub> [A]
Min.	4	0.05
Max.	60	0.52

12. Disposal

This product or parts of it must be disposed of in an environmentally sound way:

1. Use the public or private waste collection service.
2. If this is not possible, contact the nearest Grundfos company or service workshop.



The crossed-out wheeie bin symbol on a product means that it must be disposed of separately from household waste. When a product marked with this symbol reaches its end of life, take it to a collection point designated by the local waste disposal

authorities. The separate collection and recycling of such products will help protect the environment and human health.

See also end-of-life information at [www.grundfos.com/product-recycling](http://www.grundfos.com/product-recycling).

TM07 0799 1018

## Appendix

## WEEE Directive

## GB



The crossed-out wheellie bin symbol on a product means that it must be disposed of separately from household waste. When a product marked with this symbol reaches its end of life, take it to a collection point designated by the local waste disposal authorities. The separate collection and recycling of such products will help protect the environment and human

health.

## BG



Зачеркнатият символ на кофа за отпадъци върху продукта означава, че той трябва да бъде изхвърлен отделно от битовите отпадъци. Когато маркираният с този символ продукт достигне края на експлоатационния си живот, отнесете го в пункт за събиране на такива отпадъци, посочен от местните организации за третиране на отпадъци. Разделното събиране и рециклиране на подобни продукти ще спомогне за опазването на околната среда и здравето на хората.

## BS



Precrtani simbol kante za smeće na proizvodu znači da se proizvod mora odložiti odvojeno od kućnog otpada. Kada proizvod označen tim simbolom dostigne kraj radnog vijeka, odnesite ga na mjesto za prikupljanje koje određuje lokalna uprava za odlaganje otpada. Odvojeno sakupljanje i recikliranje takvih proizvoda pomoći će u zaštiti životne

sredine i zdravlja ljudi.

## CZ



Symbol přeškrtnuté popelnice na výrobku znamená, že musí být likvidován odděleně od domovního odpadu. Pokud výrobek označený tímto symbolem dosáhne konce životnosti, vezměte jej do sběrného místa určeného místními úřady pro likvidaci odpadu. Oddělený sběr a recyklace těchto výrobků pomůže chránit životní prostředí a lidské zdraví.

## DE



Das Symbol mit einer durchgestrichenen Mülltonne weist darauf hin, dass das jeweilige Produkt nicht im Haushaltsmüll entsorgt werden darf. Wenn ein Produkt, das mit diesem Symbol gekennzeichnet ist, das Ende seiner Lebensdauer erreicht hat, bringen Sie es zu einer geeigneten

Sammelstelle. Weitere Informationen hierzu erhalten Sie von den zuständigen Behörden vor Ort. Die separate Entsorgung und das Recycling dieser Produkte trägt dazu bei, die Umwelt und die Gesundheit der Menschen zu schützen.

## DK



Symbolet med den overstregede skraldespand på et produkt betyder at det skal bortskaffes adskilt fra husholdningsaffald. Når et produkt som er mærket med dette symbol er udpeget af de lokale affaldsmyndigheder. Særskilt indsamling og genbrug af sådanne produkter medvirker til at beskytte

miljøet og menneskers sundhed.

## EE



Läbikriipsutatud prügikasti sümbol pumbal tähendab, et see tuleb ära visata olmejäätmetest eraldi. Kui sellise sümboliga toode jõuab oma kasutusea lõpule, siis viige see kohaliku jäätmekäitlusettevõtte poolt määratud kogumispunkti. Selliste toodete eraldi kogumine ja ringlussevõtt kaitseb keskkonda ja inimeste tervist.

## ES



El símbolo con el contenedor tachado que aparece en el producto significa que este no debe eliminarse junto con la basura doméstica. Cuando un producto marcado con este símbolo alcance el final de su vida útil, debe llevarse a un punto de recogida selectiva designado por las autoridades locales competentes en materia de gestión de residuos. La recogida selectiva y el reciclaje de este tipo de productos contribuyen a proteger el medio ambiente y la salud de las personas.

## FI



Yliirussatun jäteastian kuva laitteessa tarkoittaa, että laite on hävitettävä erillään kotitalousjätteestä. Kun tällä symbolilla merkityn laitteen käyttöikä päättyy, vie laite asianmukaiseen SER-keräyspisteeseen. Lajittelemalla ja kierrättämällä tällaiset laitteet suojelet luontoa ja samalla edistät myös ihmisten hyvinvointia.

## FR



Le pictogramme représentant une poubelle à roulettes barrée apposé sur le produit signifie que celui-ci ne doit pas être jeté avec les ordures ménagères. Lorsqu'un produit marqué de ce pictogramme atteint sa fin de vie, l'apporter à un point de collecte désigné par les autorités locales compétentes. Le tri sélectif et le recyclage de tels produits participent à la protection de l'environnement et à la préservation de la santé des personnes.

## GR



Το σύμβολο με τον διαγραμμένο κάδο απορριμμάτων σημαίνει ότι πρέπει να απορριφθεί ξεχωριστά από τα οικιακά απορρίμματα. Όταν ένα προϊόν που φέρει αυτό το σύμβολο φτάσει στο τέλος της διάρκειας ζωής του, παραδώστε το σε ένα σημείο συλλογής το οποίο καθορίζεται από τις τοπικές αρχές διάθεσης απορριμμάτων. Η ξεχωριστή συλλογή και

ανακύκλωση τέτοιων προϊόντων θα βοηθήσει στην προστασία του περιβάλλοντος και της ανθρώπινης υγείας.

## HR



Prekriženi simbol kante za smeće na proizvodu znači da se mora zbrinuti odvojeno od otpada iz domaćinstava. Kada proizvod označen tim simbolom dosegne kraj radnog vijeka, odnesite ga u centar za prikupljanje lokalne uprave za zbrinjavanje otpada. Odvojeno prikupljanje i recikliranje takvih proizvoda pridonijet će zaštiti okoliša i zdravlja ljudi.

## HU



Az áthúzott kuka jel egy terméken azt jelenti, hogy ezt a háztartási hulladéktól elválasztva, külön kell kezelni. Amikor egy ilyen jellel ellátott termék életciklusának végéhez ér, vigye azt a helyi hulladékkezelő intézmény által kijelölt gyűjtőhelyre. Az ilyen termékek elkülönített gyűjtése és újrahasznosítása segít megővni a környezetet és az emberek

egészségét.

## ID



Simbol keranjang sampah disilang pada produk berarti produk harus dibuang secara terpisah dari limbah rumah tangga. Produk dengan simbol ini berarti masa pakainya sudah berakhir, bawalah ke pusat pengumpulan yang ditunjuk oleh otoritas pemuangan limbah setempat. Pengumpulan dan daur ulang yang terpisah dari produk tersebut akan membantu melindungi kesehatan lingkungan dan manusia.

## IS



Táknið fyrir ruslatunnu sem krossað er yfir þýðir að ekki má farga vörinni með heimilissorpi. Þegar endingartíma vöru sem merkt er með þessu tákni lýkur skal fara með hana á tiltekinn söfnunarstað hjá sorpfögunarfyriræki á staðnum. Söfnun og endurvinnsla slíkra vara hjálpar til við að vernda umhverfið og heilsu manna.

## IT



Il simbolo del bidone della spazzatura sbarrato sul prodotto indica che deve essere smaltito separatamente dai rifiuti domestici. Quando un prodotto contrassegnato con questo simbolo raggiunge la fine della vita utile, consegnarlo presso un punto di raccolta designato dagli enti locali per lo smaltimento. La raccolta differenziata ed il riciclo di tali prodotti consentono di tutelare la salute umana e l'ambiente.

## JP



1車輪つきゴミ箱にバツ印がつけられたシンボルは、家庭ごみとして捨てることのできないことを意味します。このシンボルを記載した製品を廃棄する際には、各地域の規則で定められた収集場所に出してください。このような製品を分別収集しリサイクルすることで環境および人の健康の保護につながります。

## KZ



Өнімде сызылған жылжымалы қоқыс жәшігі оның тұрмыстық қалдықтардан бөлек залалсыздандырылуы керек екенін білдіреді. Осы белгімен белгіленген өнімнің пайдалану мерзімі аяқталған кезде, оны жергілікті ұйыммен бекітілген залалсыздандыру орнына жеткізіңіз. Мұндай өнімдерді жеке жинау және қайта өңдеу қоршаған ортаны және адам денсаулығын сақтауға көмектеседі.

## KO



가위표가 표시된 바퀴 달린 쓰레기통 기호는 제품을 가장중 폐기물과 별도로 폐기해야 한다는 것을 뜻합니다. 이 기호가 표시된 제품의 수명이 종료되면, 현지 폐기를 처리 당국이 지정한 수거 장소로 제품을 가져가십시오. 그러한 제품의 별도의 수거 및 재활용은 환경과 건강을 보호합니다.

## LT



Ant produkto esantis perbraukto šiukšlių konteinerio simbolis nurodo, kad produktą draudžiama išmesti su buitiniemis atliekomis. Kai šiuo simboliu pažymėtas produktas nustojamas naudoti, jį reikia pristatyti į vietinių institucijų nurodytą atliekų surinkimo vietą. Atskiras tokių produktų surinkimas ir perdėrimas padeda saugoti aplinką ir žmonių sveikatą.

## LV



Uz produkta norādītais nosvītrotās atkritumu tvertnes simbols nozīmē, ka produkts ir jālikvidē atsevišķi, nevis kopā ar sadzīves atkritumiem. Kad produkts, kas ir marķēts ar šo simbolu, sasniedz darbmūža beigas, nogādājiet to savākšanas punktā, ko norādījušas vietējās atkritumu apsaimniekošanas iestādes. Šādu produktu atsevišķā savākšana un pārstrāde palīdz aizsargāt vidi un cilvēku veselību.

## MK



Симболот со прецртана корпа за отпадоци на тркала на производот значи дека мора да се отстрани во отпад одделно од домашниот отпад. Кога производ означен со овој симбол ќе стигне до крајот на својот работен век, однесете го на место за собирање отпад означено од страна на локалните комунални служби. Одделното собирање и рециклирање на таквите производи ќе помогне при заштита на животната средина и здравјето на луѓето.

## MY



Simbol tong sampah berada dipangkah pada produk bermakna ia perlu dilupuskan berasingan daripada sisa isi rumah. Apabila produk ditanda dengan simbol ini mencapai akhir hayatnya, bawanya ke pusat pengumpulan yang ditetapkan pihak berkuasa pelupusan sisa tempatan. Pengumpulan dan kitar semula berasingan produk seumpamanya akan membantu melindungi alam sekitar dan kesihatan manusia.

## NL



Het doorkruiste symbool van een afvalbak op een product betekent dat het gescheiden van het normale huishoudelijke afval moet worden verwerkt en afgevoerd. Als een product dat met dit symbool is gemarkeerd het einde van de levensduur heeft bereikt, brengt u het naar een inzamelpunt dat hiertoe is aangewezen door de plaatselijke afvalverwerkingsautoriteiten. De gescheiden inzameling en recycling van dergelijke producten helpt het milieu en de menselijke gezondheid te beschermen.

## NO



Symbolet for overkryset søppeldunk på et produkt betyr at det må kasseres atskilt fra husholdningsavfall. Når et produkt merket med dette symbolet når endt levetid, skal det fraktes det til et offentlig godkjent mottak. Atskilt innsamling og resirkulering av slike produkter vil bidra til å beskytte miljø og mennesker.

## PL



Symbol przekreślonego pojemnika na odpady oznacza, że produktu nie należy składować razem z odpadami komunalnymi. Po zakończeniu eksploatacji produktu oznaczonego tym symbolem należy dostarczyć go do punktu selektywnej zbiórki odpadów wskazanego przez władze lokalne. Selektywna zbiórka i recykling takich produktów pomagają chronić środowisko naturalne i zdrowie ludzi.

## PT



O símbolo do caixote do lixo riscado no produto significa que este deve ser eliminado separadamente do lixo doméstico. Quando um produto marcado com este símbolo atingir o fim da sua vida útil, leve-o para um ponto de recolha designado pelas autoridades locais responsáveis pela eliminação de resíduos. A recolha e reciclagem destes produtos em separado ajudará a proteger o ambiente e a saúde das pessoas.

## RO



Simbolul de pebelă întretăiată aflată pe un produs denotă faptul că acesta trebuie depus la deșeurii separat de gunoii menajer. Când un produs cu acest simbol ajunge la sfârșitul duratei de viață, acesta trebuie dus la un punct de colectare desemnat de către autoritățile locale de administrare a deșeurilor. Colectarea și reciclarea separate ale acestor produse vor ajuta la protejarea mediului înconjurător și a sănătății umane.

## RS



Prečrtani simbol kante za smeće na proizvodu znači da se proizvod mora odložiti odvojeno od kućnog otpada. Kada proizvod označen tim simbolom dostigne kraj radnog veka, odnesite ga na mesto za prikupljanje koje određuje lokalna uprava za odlaganje otpada. Odvojeno sakupljanje i reciklaža takvih proizvoda pomoći će u zaštiti životne sredine i zdravlja ljudi.

## RU



Изображение перечёркнутого мусорного ведра на изделии означает, что его необходимо утилизировать отдельно от бытовых отходов. Когда изделие с таким обозначением достигнет конца своего срока службы, необходимо доставить его в пункт сбора и утилизировать в соответствии с требованиями местного законодательства в области экологии. Раздельный сбор и переработка таких изделий помогут защитить окружающую среду и здоровье человека.

## SE



Symbolen med en överkorsad soptunna på en produkt betyder att den inte får kasseras som hushållsavfall. När en produkt märkt med denna symbol är trasig och inte repararbar skall den inlämnas enligt anvisningar från lokala avfallshanteringsmyndigheter. Separat insamling och återvinning av sådana produkter hjälper till att skydda miljön och människors hälsa.

## SI



Simbol prečrtanega smetnjaka na izdelku označuje, da morate izdelek zavreči ločeno od gospodinjskih odpadkov. Ko izdelek, ki je označen s tem simbolom, doseže konec življenjske dobe, ga odnesite na zbirno mesto, ki ga določijo lokalni organi za odstranjevanje odpadkov. Z ločenim zbiranjem in recikliranjem teh izdelkov pomagata pri varovanju okolja in zdravju ljudi.

## SK



Preškrtnutý symbol odpadkovej nádoby na produkte znamená, že produkt musí byť zlikvidovaný oddelene od bežného domového odpadu. Ak produkt, označený týmto symbolom, dosiahne koniec svojej životnosti, odnesite ho na zberné miesto, určené miestnymi orgánmi pre likvidáciu odpadu. Samostatný zber a recyklácia takýchto produktov pomôže chrániť životné prostredie a ľudské zdravie.

## TH



เครื่องหมายถังขยะติดลิ่มกากบาทบนผลิตภัณฑ์หมายถึงจะต้องกำจัดหรือคัดแยกผลิตภัณฑ์จากขยะตามบ้านเรือนเมื่อผลิตภัณฑ์ที่มีเครื่องหมายนี้หมดอายุการใช้งานแล้วให้นำไปยังจุดเก็บรวบรวมที่หน่วยงานกำจัดขยะในท้องถิ่นกำหนดไว้ การเก็บแยกและรีไซเคิลผลิตภัณฑ์ดังกล่าว จะช่วยปกป้องสิ่งแวดล้อมและสุขภาพของมนุษย์

## TR



Ürün üzerinde bulunan çarpı işaretli çöp kutusu sembolü, ürünün evsel atıklardan ayrı olarak imha edilmesi gerektiğini belirtir. Bu sembolle işaretlenmiş bir ürünü, kullanım ömrünün sonuna ulaştığında yerel atık imha yetkilileri tarafından belirlenen bir toplama noktasına götürün. Bu ürünlerin ayrı toplanması ve geri dönüştürülmesi, çevreyi ve insan sağlığını korumaya yardımcı olacaktır.

## UA



Символ перекресленого сміттьового контейнера на виробі означає, що він повинен утилізуватися окремо від побутових відходів. Коли термін служби виробу, на якому є такий символ, добігає кінця, його слід відвезти до пункту збору сміття, визначеного місцевим управлінням з видалення відходів. Окрема утилізація таких виробів допоможе захистити довкілля та здоров'я людей.

VI



Biểu tượng thùng rác bánh xe bị gạch chéo trên một sản phẩm có nghĩa là nó phải được vứt bỏ tách riêng với rác sinh hoạt. Khi có sản phẩm được đánh dấu biểu tượng này đến cuối hạn sử dụng thì hãy đưa nó tới điểm thu nhập do cơ quan quản lý rác thải địa phương chỉ định. Việc thu gom tách biệt và tái chế những sản phẩm này sẽ giúp bảo vệ môi trường và sức khỏe con người.

TW



產品上打叉的帶輪垃圾桶符號表示此產品必須與家庭廢棄物分開丟棄。標示此符號的產品在使用壽命結束時，請將此產品送到當地廢棄物處理主管機關指定的收集站。分開收集與回收此類產品，有助於保護環境與人類健康。

AR



يعني رمز حاوية القمامة ذات العجلات المشطوب عليه الظاهر على أحد المنتجات أنه يجب التخلص من المنتج بشكل منفصل عن النفايات المنزلية. عندما تنتهي صلاحية أحد المنتجات المزودة بهذا الرمز، خذته إلى نقطة التجميع المخصصة من قبل سلطات التخلص من النفايات المحلية. سيساعد تجميع تلك المنتجات وإعادة تدويرها بشكل منفصل في حماية البيئة وصحة الإنسان.

**Argentina**

Bombas GRUNDFOS de Argentina S.A.  
Ruta Panamericana km. 37.500 Centro  
Industrial Garin  
1619 Garin Pcia. de B.A.  
Phone: +54-3327 414 444  
Telefax: +54-3327 45 3190

**Australia**

GRUNDFOS Pumps Pty. Ltd.  
P.O. Box 2040  
Regency Park  
South Australia 5942  
Phone: +61-8-8461-4611  
Telefax: +61-8-8340 0155

**Austria**

GRUNDFOS Pumpen Vertrieb Ges.m.b.H.  
Grundfosstraße 2  
A-5082 Grödig/Salzburg  
Tel.: +43-6246-883-0  
Telefax: +43-6246-883-30

**Belgium**

N.V. GRUNDFOS Bellux S.A.  
Boomssesteenweg 81-83  
B-2630 Aartselaar  
Tél.: +32-3-870 7300  
Télécopie: +32-3-870 7301

**Belarus**

Представительство ГРУНДФОС в  
Минске  
220125, Минск  
ул. Шафарьянская, 11, оф. 56, БЦ  
«Порт»  
Тел.: +7 (375 17) 286 39 72/73  
Факс: +7 (375 17) 286 39 71  
E-mail: minsk@grundfos.com

**Bosnia and Herzegovina**

GRUNDFOS Sarajevo  
Zmaja od Bosne 7-7A,  
BH-71000 Sarajevo  
Phone: +387 33 592 480  
Telefax: +387 33 590 465  
www.ba.grundfos.com  
e-mail: grundfos@bih.net.ba

**Brazil**

BOMBAS GRUNDFOS DO BRASIL  
Av. Humberto de Alencar Castelo Branco,  
630  
CEP 09850 - 300  
São Bernardo do Campo - SP  
Phone: +55-11 4393 5533  
Telefax: +55-11 4343 5015

**Bulgaria**

Grundfos Bulgaria EOOD  
Slatina District  
Iztochna Tangenta street no. 100  
BG - 1592 Sofia  
Tel. +359 2 49 22 200  
Fax. +359 2 49 22 201  
email: bulgaria@grundfos.bg

**Canada**

GRUNDFOS Canada Inc.  
2941 Brighton Road  
Oakville, Ontario  
L6H 6C9  
Phone: +1-905 829 9533  
Telefax: +1-905 829 9512

**China**

GRUNDFOS Pumps (Shanghai) Co. Ltd.  
10F The Hub, No. 33 Suhong Road  
Minhang District  
Shanghai 201106  
PRC  
Phone: +86 21 612 252 22  
Telefax: +86 21 612 253 33

**COLOMBIA**

GRUNDFOS Colombia S.A.S.  
Km 1.5 vía Siberia-Cota Conj. Potrero  
Chico,  
Parque Empresarial Arcos de Cota Bod.  
1A.  
Cota, Cundinamarca  
Phone: +57(1)-2913444  
Telefax: +57(1)-8764586

**Croatia**

GRUNDFOS CROATIA d.o.o.  
Buzinski prilaz 38, Buzin  
HR-10010 Zagreb  
Phone: +385 1 6595 400  
Telefax: +385 1 6595 499  
www.hr.grundfos.com

**GRUNDFOS Sales Czechia and Slovakia s.r.o.**

Čajkovského 21  
779 00 Olomouc  
Phone: +420-585-716 111

**Denmark**

GRUNDFOS DK A/S  
Martin Bachs Vej 3  
DK-8850 Bjerringbro  
Tlf.: +45-87 50 50 50  
Telefax: +45-87 50 51 51  
E-mail: info\_GDK@grundfos.com  
www.grundfos.com/DK

**Estonia**

GRUNDFOS Pumps Eesti OÜ  
Peterburi tee 92G  
11415 Tallinn  
Tel: + 372 606 1690  
Fax: + 372 606 1691

**Finland**

OY GRUNDFOS Pumput AB  
Trukkikuja 1  
FI-01360 Vantaa  
Phone: +358-(0) 207 889 500

**France**

Pompes GRUNDFOS Distribution S.A.  
Parc d'Activités de Chesnes  
57, rue de Malacombe  
F-38290 St. Quentin Fallavier (Lyon)  
Tél.: +33-4 74 82 15 15  
Télécopie: +33-4 74 94 10 51

**Germany**

GRUNDFOS GMBH  
Schlüterstr. 33  
40699 Erkrath  
Tel.: +49-(0) 211 929 69-0  
Telefax: +49-(0) 211 929 69-3799  
e-mail: infoservice@grundfos.de  
Service in Deutschland:  
e-mail: kundendienst@grundfos.de

**Greece**

GRUNDFOS Hellas A.E.B.E.  
20th km. Athinon-Markopoulou Av.  
P.O. Box 71  
GR-19002 Peania  
Phone: +0030-210-66 83 400  
Telefax: +0030-210-66 46 273

**Hong Kong**

GRUNDFOS Pumps (Hong Kong) Ltd.  
Unit 1, Ground floor  
Siu Wai Industrial Centre  
29-33 Wing Hong Street &  
68 King Lam Street, Cheung Sha Wan  
Kowloon  
Phone: +852-27861706 / 27861741  
Telefax: +852-27858664

**Hungary**

GRUNDFOS Hungária Kft.  
Tópark u. 8  
H-2045 Törökbálint,  
Phone: +36-23 511 110  
Telefax: +36-23 511 111

**India**

GRUNDFOS Pumps India Private Limited  
118 Old Mahabalipuram Road  
Thoraiakkam  
Chennai 600 096  
Phone: +91-44 2496 6800

**Indonesia**

PT. GRUNDFOS POMPA  
Graha Intirub Lt. 2 & 3  
Jln. Cililitan Besar No.454. Makasar,  
Jakarta Timur  
ID-Jakarta 13650  
Phone: +62 21-469-51900  
Telefax: +62 21-460 6910 / 460 6901

**Ireland**

GRUNDFOS (Ireland) Ltd.  
Unit A, Merrywell Business Park  
Ballymount Road Lower  
Dublin 12  
Phone: +353-1-4089 800  
Telefax: +353-1-4089 830

**Italy**

GRUNDFOS Pompe Italia S.r.l.  
Via Gran Sasso 4  
I-20060 Truccazzano (Milano)  
Tel.: +39-02-95838112  
Telefax: +39-02-95309290 / 95838461

**Japan**

GRUNDFOS Pumps K.K.  
1-2-3, Shin-Miyakoda, Kita-ku,  
Hamamatsu  
431-2103 Japan  
Phone: +81 53 428 4760  
Telefax: +81 53 428 5005

**Korea**

GRUNDFOS Pumps Korea Ltd.  
6th Floor, Aju Building 679-5  
Yeoksam-dong, Kangnam-ku, 135-916  
Seoul, Korea  
Phone: +82-2-5317 600  
Telefax: +82-2-5633 725

**Latvia**

SIA GRUNDFOS Pumps Latvia  
Deglava biznesa centrs  
Augusta Deglava ielā 60, LV-1035, Rīga,  
Tālr.: + 371 714 9640, 7 149 641  
Fakss: + 371 914 9646

**Lithuania**

GRUNDFOS Pumps UAB  
Smolensko g. 6  
LT-03201 Vilnius  
Tel: + 370 52 395 430  
Fax: + 370 52 395 431

**Malaysia**

GRUNDFOS Pumps Sdn. Bhd.  
7 Jalan Peguam U1/25  
Glenmarie Industrial Park  
40150 Shah Alam  
Selangor  
Phone: +60-3-5569 2922  
Telefax: +60-3-5569 2866

**Mexico**

Bombas GRUNDFOS de México S.A. de  
C.V.  
Boulevard TLC No. 15  
Parque Industrial Stiva Aeropuerto  
Apodaca, N.L. 66600  
Phone: +52-81-8144 4000  
Telefax: +52-81-8144 4010

**Netherlands**

GRUNDFOS Netherlands  
Veluwezoom 35  
1326 AE Almere  
Postbus 22015  
1302 CA ALMERE  
Tel.: +31-88-478 6336  
Telefax: +31-88-478 6332  
E-mail: info\_gnl@grundfos.com

**New Zealand**

GRUNDFOS Pumps NZ Ltd.  
17 Beatrice Tinsley Crescent  
North Harbour Industrial Estate  
Albany, Auckland  
Phone: +64-9-415 3240  
Telefax: +64-9-415 3250

**Norway**

GRUNDFOS Pumper A/S  
Strømsveien 344  
Postboks 235, Leirdal  
N-1011 Oslo  
Tlf.: +47-22 90 47 00  
Telefax: +47-22 32 21 50

**Poland**

GRUNDFOS Pompy Sp. z o.o.  
ul. Klonowa 23  
Baranowo k. Poznania  
PL-62-081 Przeźmierowo  
Tel: (+48-61) 650 13 00  
Fax: (+48-61) 650 13 50

**Portugal**

Bombas GRUNDFOS Portugal, S.A.  
Rua Calvet de Magalhães, 241  
Apartado 1079  
P-2770-153 Paço de Arcos  
Tel.: +351-21-440 76 00  
Telefax: +351-21-440 76 90

**Romania**

GRUNDFOS Pompe România SRL  
Bd. Biruintei, nr 103  
Pantelimon county Ilfov  
Phone: +40 21 200 4100  
Telefax: +40 21 200 4101  
E-mail: romania@grundfos.ro

**Russia**

ООО Грундфос Россия  
ул. Школьная, 39-41  
Москва, RU-109544, Russia  
Тел. (+7) 495 564-88-00 (495) 737-30-00  
Факс (+7) 495 564 8811  
E-mail grundfos.moscow@grundfos.com

**Serbia**

Grundfos Srbija d.o.o.  
Omladinskih brigada 90b  
11070 Novi Beograd  
Phone: +381 11 2258 740  
Telefax: +381 11 2281 769  
www.rs.grundfos.com

**Singapore**

GRUNDFOS (Singapore) Pte. Ltd.  
25 Jalan Tukang  
Singapore 619264  
Phone: +65-6681 9688  
Telefax: +65-6681 9689

**Slovakia**

GRUNDFOS s.r.o.  
Prievozská 4D  
821 09 BRATISLAVA  
Phona: +421 2 5020 1426  
sk.grundfos.com

**Slovenia**

GRUNDFOS LJUBLJANA, d.o.o.  
Leskoškova 9e, 1122 Ljubljana  
Phone: +386 (0) 1 568 06 10  
Telefax: +386 (0) 1 568 06 19  
E-mail: tehnika-si@grundfos.com

**South Africa**

Grundfos (PTY) Ltd.  
16 Lascelles Drive, Meadowbrook Estate  
1609 Germiston, Johannesburg  
Tel.: (+27) 10 248 6000  
Fax: (+27) 10 248 6002  
E-mail: lgradidge@grundfos.com

**Spain**

Bombas GRUNDFOS España S.A.  
Camino de la Fuentequilla, s/n  
E-28110 Algete (Madrid)  
Tel.: +34-91-848 8800  
Telefax: +34-91-628 0465

**Sweden**

GRUNDFOS AB  
Box 333 (Lunnagårdsgatan 6)  
431 24 Mölndal  
Tel.: +46 31 332 23 000  
Telefax: +46 31 331 94 60

**Switzerland**

GRUNDFOS Pumpen AG  
Bruggacherstrasse 10  
CH-8117 Fällanden/ZH  
Tel.: +41-44-806 8111  
Telefax: +41-44-806 8115

**Taiwan**

GRUNDFOS Pumps (Taiwan) Ltd.  
7 Floor, 219 Min-Chuan Road  
Taichung, Taiwan, R.O.C.  
Phone: +886-4-2305 0868  
Telefax: +886-4-2305 0878

**Thailand**

GRUNDFOS (Thailand) Ltd.  
92 Chaloe Phrakiat Rama 9 Road,  
Dokmai, Pravej, Bangkok 10250  
Phone: +66-2-725 8999  
Telefax: +66-2-725 8998

**Turkey**

GRUNDFOS POMPA San. ve Tic. Ltd. Sti.  
Gebze Organize Sanayi Bölgesi  
İhsan dede Caddesi,  
2. yol 200. Sokak No. 204  
41490 Gebze/ Kocaeli  
Phone: +90 - 262-679 7979  
Telefax: +90 - 262-679 7905  
E-mail: satis@grundfos.com

**Ukraine**

Бізнес Центр Європа  
Столицне шосе, 103  
м. Київ, 03131, Україна  
Телефон: (+38 044) 237 04 00  
Факс.: (+38 044) 237 04 01  
E-mail: ukraine@grundfos.com

**United Arab Emirates**

GRUNDFOS Gulf Distribution  
P.O. Box 16768  
Jebel Ali Free Zone  
Dubai  
Phone: +971 4 8815 166  
Telefax: +971 4 8815 136

**United Kingdom**

GRUNDFOS Pumps Ltd.  
Grovebury Road  
Leighton Buzzard/Beds. LU7 4TL  
Phone: +44-1525-850000  
Telefax: +44-1525-850011

**U.S.A.**

GRUNDFOS Pumps Corporation  
9300 Loiret Blvd.  
Lenexa, Kansas 66219  
Phone: +1-913-227-3400  
Telefax: +1-913-227-3500

**Uzbekistan**

Grundfos Tashkent, Uzbekistan The  
Representative Office of Grundfos  
Kazakhstan in Uzbekistan  
38a, Oybek street, Tashkent  
Телефон: (+998) 71 150 3290 / 71 150  
3291  
Факс: (+998) 71 150 3292

Addresses Revised 15.01.2019

<b>99253352</b> 0419
----------------------

ECM: 1259256
--------------

Trademarks displayed in this material, including but not limited to Grundfos, the Grundfos logo and "be think innovate" are registered trademarks owned by The Grundfos Group. All rights reserved. © 2019 Grundfos Holding A/S, all rights reserved.