

# HUSTLE L

Pool table / Pooltisch / Pooltafel /  
Table de billard / mesa de billar / tavolo da biliardo



## INSTRUCTION MANUAL

Keep instructions for later use

## GEBRAUCHSANWEISUNG

Anleitung zum späteren Gebrauch aufbewahren

## GEbruIKSHANDLEIDING

Handleiding bewaren voor later gebruik

## MODE D'EMPLOI

Conserver la notice pour usage ultérieur

## MANUAL DE USUARIO

Guardar estas Instrucciones para su uso future

## ISTRUZIONE PER L'USO

Conservare l'istruzioni per uso successivo

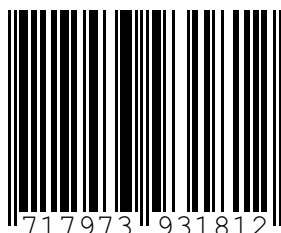

Article number /  
Artikelnummer /  
Artikelnummer /  
Numéro d'article /  
Número de artículo /  
Codice articolo

**A040.201.00**



## ! NOTICE



### WARNING

#### CHOKING HAZARD

Small parts. Not suitable for children under 36 months.



### WARNING

THE PRODUCT IS TO BE ASSEMBLED BY AN ADULT.



### WARNING

Potential hazard description, e.g. In unassembled state contain potentially hazardous sharp points, so please keep out of baby's reach.

Only for domestic use.  
Retain for future reference.



### WARNUNG

#### VERSCHLUCKUNGSGEFAHR

Kleine Teile. Für Kinder unter 3 Jahren nicht geeignet.



### WARNUNG

DAS PRODUKT IST VON EINEM ERWACHSENEN ZUSAMMENGEBAUT WERDEN.



### WARNUNG

Beschreibung potenzieller Gefahr, z.B. in nicht zusammengesetztem Zustand enthält es potenziell gefährliche scharfe Spitzen, daher von Babys fernhalten!

Nur für den häuslichen Gebrauch.  
Diese Informationen aufheben.



### WAARSCHUWING

#### VERSTIKKINGSGEVAAR

Kleine onderdelen. Niet geschikt voor kinderen onder de 36 maanden.



### WAARSCHUWING

HET PRODUCT MOET DOOR EEN VOLWASSEN GEMONTEERD WORDEN.



### WAARSCHUWING

Beschrijving potentieel gevaar, bv in ongemonteerde toestand bevat het potentieel gevaarlijke punten, zorg ervoor dat baby's er niet bij kunnen.

Alleen geschikt voor particulier gebruik.  
Bewaar deze informatie.

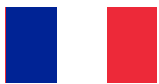

### AVERTISSEMENT

#### RISQUE D'ÉTOUFFEMENT

Petit matériel. Ne convient pas pour les enfants de moins de 36 mois.



### AVERTISSEMENT

LE PRODUIT DOIT ÊTRE ASSEMBLÉ PAR UN ADULTE.



### AVERTISSEMENT

Description de risque potentiel, par exemple, Démonté, contient des pointes potentiellement dangereuses. À conserver hors de portée des enfants en bas âge.

Convient uniquement pour l'utilisation.  
Conserver pour une consultation ultérieure.



### ADVERTENCIA

#### PELIGRO DE ASFIXIA

Piezas pequeñas. No adecuado para menores de 36 meses.



### ADVERTENCIA

EL PRODUCTO DEBE SER MONTADO POR UN ADULTO



### ADVERTENCIA

Descripción de posible peligro, p. ej.: El producto desmontado contiene posibles puntos afilados, así que debe mantenerse fuera del alcance del bebé

Sólo para uso doméstico.  
Conservar para futuras consultas.



### AVVERTENZA

#### PERICOLO DI SOFFOCAMENTO

Componenti di piccole dimensioni. Non adatto per bambini di età inferiore a 36 mesi.



### AVVERTENZA

IL GIOCATTOLO DEVE ESSERE MONTATO DA UN ADULTO.











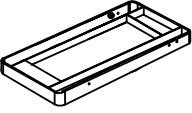

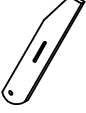
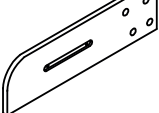
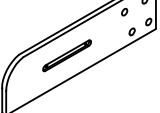
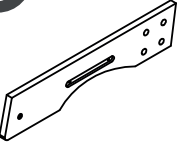
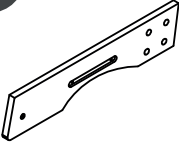
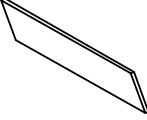
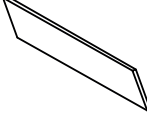
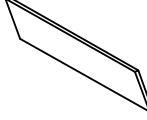
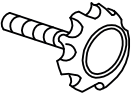
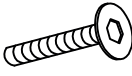

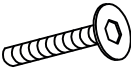
### AVVERTENZA

Descrizione dei rischi potenziali, ad es. in condizioni smontate contiene parti acuminate potenzialmente pericolose; tenere quindi fuori dalla portata del bambino.

Esclusivamente per uso domestico.  
Conservare per riferimento futuro.

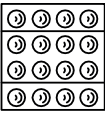
## PARTS

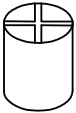
<p><b>1</b></p>  <p>x1</p>	<p><b>2</b></p>  <p>x1</p>	<p><b>3</b></p>  <p>x1</p>	<p><b>4</b></p>  <p>x1</p>	<p><b>5</b></p>  <p>x1</p>
<p><b>6</b></p>  <p>x1</p>	<p><b>7</b></p>  <p>x1</p>	<p><b>8</b></p>  <p>x1</p>	<p><b>9</b></p>  <p>x1</p>	<p><b>10</b></p>  <p>x1</p>
<p><b>11</b></p>  <p>x6</p>	<p><b>12</b></p>  <p>x12</p>	<p><b>13</b></p>  <p>x12</p>	<p><b>14</b></p>  <p>x8</p>	<p><b>15</b></p>  <p>x8</p>
<p><b>16</b></p>  <p>x2</p>	<p><b>17</b></p>  <p>x1</p>	<p><b>18</b></p>  <p>x1</p>	<p><b>19</b></p>  <p>x2</p>	<p><b>20</b></p>  <p>x1</p>
<p><b>21</b></p>  <p>x1</p>	<p><b>22</b></p>  <p>x12</p>			



## ASSEMBLY

2

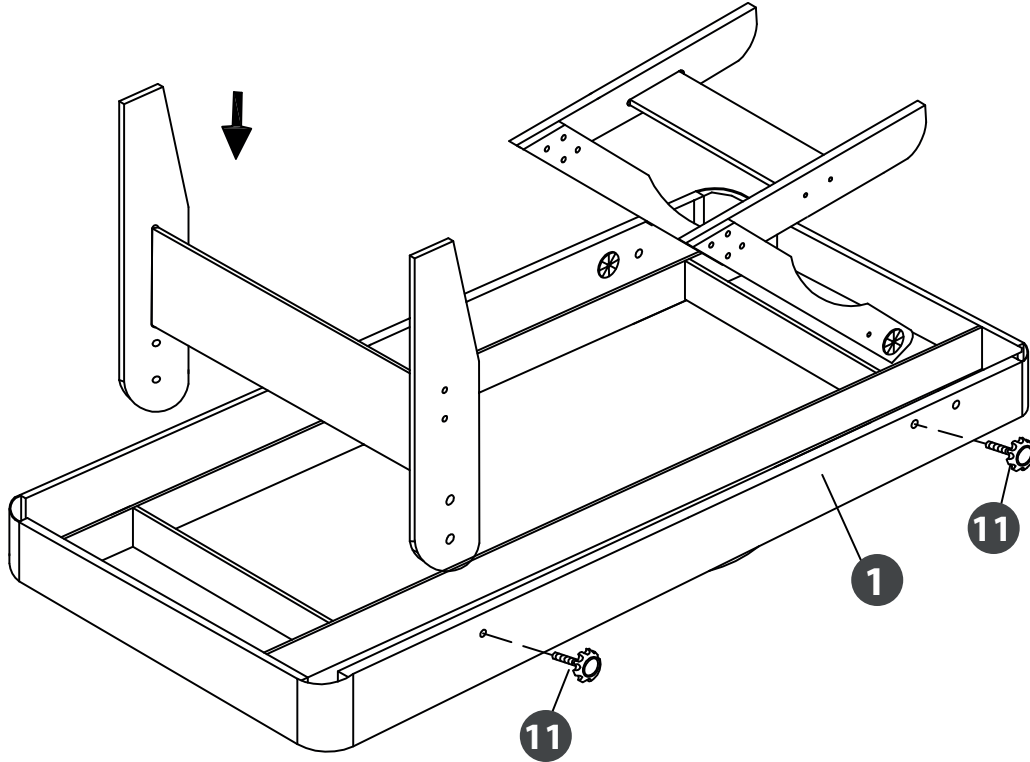

3

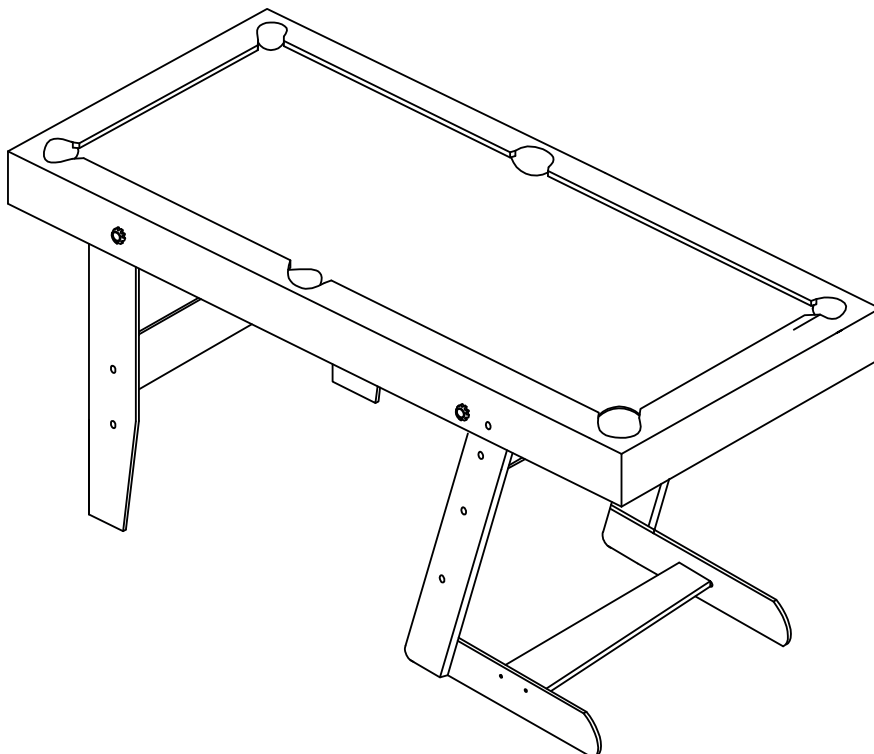

## ASSEMBLY

4

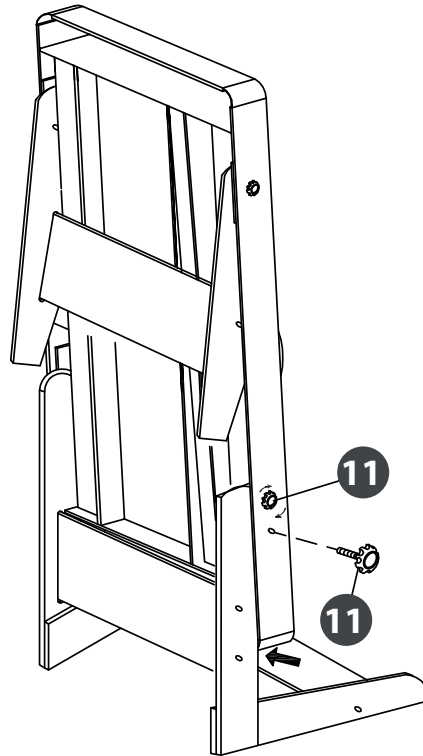

5

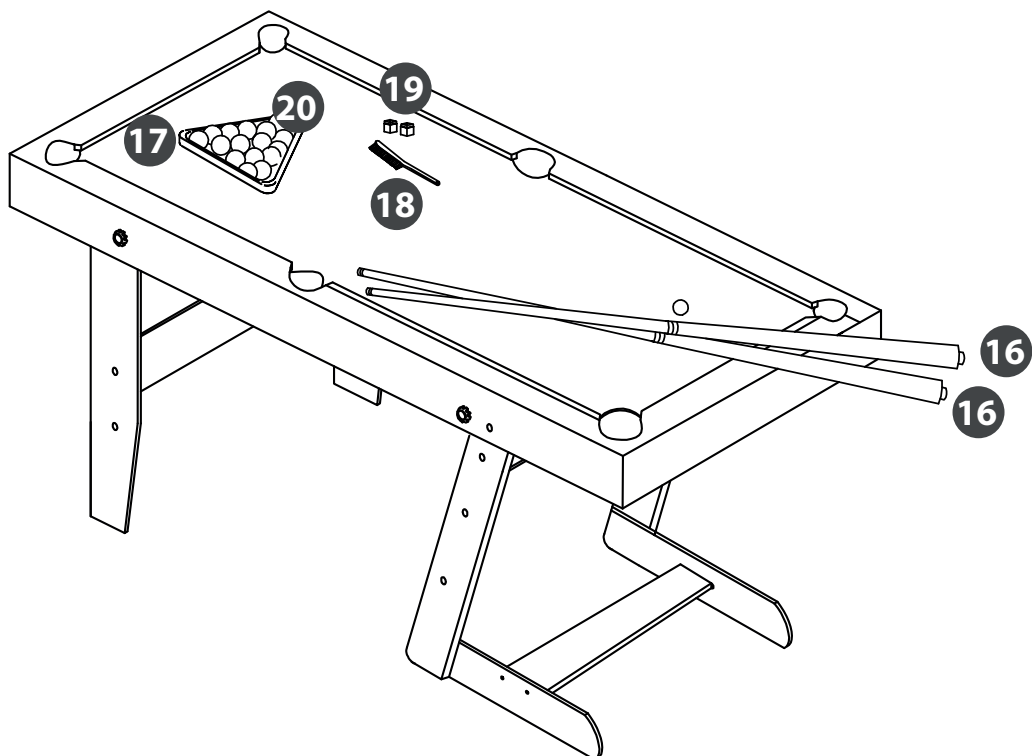

## GUARANTEE

Congratulations on your purchase of the Cougar Offside. You have bought a product you will enjoy for many years. Cougar provides a 2-year guarantee on this product, when properly used. If the product does not reach you in good condition or if there are other problems, please contact your dealer or point of sale where you purchased the product.

Herzlichen Glückwunsch zum Erwerb der Cougar Offside. Mit Ihrer Entscheidung haben Sie ein Produkt erworben, an dem Sie viele Jahre lang Freude haben werden. Cougar gibt eine Garantie von 2 Jahren auf dieses Produkt, bei richtiger Verwendung. Wenn Sie das Produkt nicht in einwandfreiem Zustand erhalten oder wenn sich andere Probleme ergeben, wenden Sie sich dann an den Händler oder die Verkaufsstelle, wo Sie das Produkt erworben haben.

Gefeliciteerd met uw aankoop van de Cougar Offside. Met deze keuze heeft u een product gekocht waarvan u jarenlang plezier zult hebben. Cougar verstrekt op dit product - bij juist gebruik - een garantie van 2 jaar. Mocht het product u niet in goede staat bereiken of als er zich andere problemen voordoen, neem dan contact op met uw dealer of verkooppunt waar u het product heeft aangeschaft.

Félicitations pour votre achat du Cougar Offside. Vous avez choisi un produit qui vous apportera du bonheur pendant des années. Sur le produit, Cougar offre une garantie de 2 ans, à condition de l'utiliser de manière adéquate. Veuillez contacter votre revendeur ou le point de vente où vous l'avez acheté si le produit n'est pas livré en bon état ou si vous constatez un autre problème.

Felicidades por la compra del Cougar Offside. Al elegir nuestra marca, usted disfrutará muchos años de un producto de calidad. Cougar ofrece una garantía de 2 años el producto, siempre que se utilicen de forma adecuada. Si el producto no cumple con las especificaciones en el momento de la entrega o en caso de otros problemas, contáctese con el distribuidor o el punto de venta donde se realizó la compra.

Congratulazioni per l'acquisto della Cougar Offside. Con l'acquisto dei nostri prodotti avete scelto una qualità che dura nel tempo. Il prodotto - fermo restando un idoneo utilizzo - da una garanzia Cougar di 2 anni. Qualora il prodotto non risulti conforme alle specifiche all'atto della consegna o in caso di altri inconvenienti, contattare il rivenditore o il punto vendita presso cui è avvenuto l'acquisto.

## **WARNING!**

Manufacturer and seller expressly disclaim any and all liability for personal injury, property damage or loss, either direct, indirect or incidental, resulting from the incorrect attachment, improper use, inadequate maintenance, or neglect of this product.



*great games*

**Pragma**  
the multi-brand company

**A Pragma Brand**

Cougar is one of our brands  
with fun table games of great quality  
that provides hours of fun!

**Pragma / Cougar**

Kruisboog 40  
3905 TG Veenendaal  
Netherlands  
T: +31 (0)318 - 57 88 00  
info@pragma-trading.com  
www.pragma-trading.com

Article number / Artikelnummer / Artikelnummer /  
Numéro d'article / Número de artículo / Codice articolo

**A040.201.00**

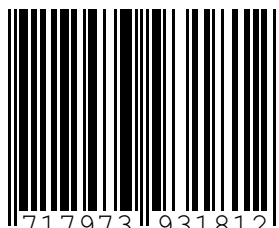

8 717973 931812

190311JW