

ACV-8305W Quick start guide

Overview

DENVER 360°Camera is a digital panoramic camera with two lenses. Through the application of up-to-date technologies, it enables you to get panoramic videos and photos, creating an experience of brand new panoramic world.

Important

- Before using this product, please carefully read this Manual
- Prepare one 32G (Class 6~Class 10) Micro SD card
- Check the camera power. A full charging is recommended before use (Until the charging indicator goes out)
- Search for “Denver 360° action camera” on Apple Store and Google Playstore, and then download and install it

About Camera

1. LCD display
2. Power button/Mode button
3. WIFI indicator (red)
4. Power indicator (red) /Charging indicator (blue)
5. Wifi button/MENU button
6. Busy indicator (red)

ACV-8305W Quick start guide

7. Shutter button/OK button
8. Lens×2
9. Triangle nut
10. Interface cover (USB/Micro SD)
11. Speaker
12. Microphone
13. Rope hole
14. Reset hole

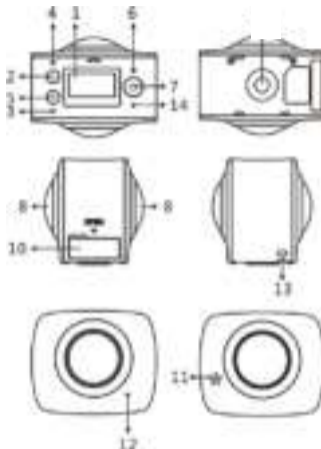

ACV-8305W Quick start guide

Quick start guide

1. Install SD card:

Insert the Micro SD card you prepare into the indicated, as shown on the right.



slot as

Important:

- A high-speed Micro SD card between Class 6~Class 10 is a must; or else, this product may not work normally.
- Always turn off the camera before inserting or pulling out of the card.

2. Power-on/off

Power-on: Press and hold Power button for about 2 seconds and release, until it beeps. The display screen will be lighted, as shown below, indicating the product is ready to work (the default work mode after power-on is video mode).

ACV-8305W Quick start guide

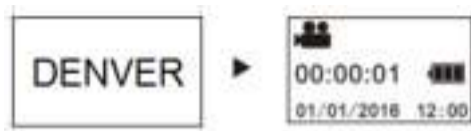

Important:

- If power-on fails, charge the camera first, and see whether the blue indicator lights up during charging. If yes, it indicates the product is being charged.

Power-off: After video stops, press and hold Power button for about 3 seconds and release. The Display will display "GOODBYE" and turns off. No operation on mainframe for 3 minutes under Power-save mode (default), the camera will automatically power off.



ACV-8305W Quick start guide

3. Charging

Use data cable included in the product pack for camera charging. During charging, the indicator displays in blue and lights constantly; when charging completed, the blue indicator goes out.

Important:

- If other charger is used, check the output power before use to ensure it within 5V/0.5A ~ 5V/2.0A.

4. Video or photo

This camera has Video mode and photo mode. After power-on, press MODE (Power button) to switch between different modes, and the corresponding mode icon will be displayed on the screen.

Video: In Video mode, press Shutter button, and the camera get started to work. The display screen displays the video timing.



ACV-8305W Quick start guide

(With maximum 2GB video recording and then stop.Must be started manually on the camera again.)

Stop video : During video , press Shutter button to stop it. The video will automatically be saved on your camera storage card. At that moment, the display screen will show remaining time available for video as below:



photo : In photo mode, press photo button to take photos. After photo , the display screen will display the number (estimated value) of pictures the available space on your camera storage card can save.

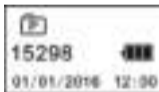

5. Menu setting

To operate Menu, press and hold WIFI button for about 2 seconds to enter menu

ACV-8305W Quick start guide

setting (as shown below):

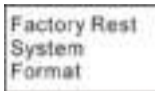
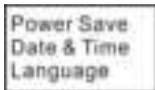

Menu operation:

In Menu mode, press WIFI button to move cursor. Press Shutter button to confirm. Press and hold WIFI button to back to previous menu or exit Menu mode.

Explanation of menu functions:

Power Save: Set Power-save mode. You may set the camera to enter Power-save mode after a certain period of time. The available options are 1min/3min/5min or Power-save mode off.

Date & Time: Set system time for the camera manually.

Language: Set system language for the camera, with English as its default language.

Factory Reset: Restore factory default settings.

System: Check system and storage card information.

Format: Format storage card.

ACV-8305W Quick start guide

Important:

After formatting, all existing data on the storage card will be lost due to such formatting. Please be cautious to this operation!

6. How to use accessories properly

It is strongly recommended to use the accessories originally provided by the manufacturer. It helps create a better product use experience and better photo/video effect.

Tripod: Screw the tripod nut attached into the screw hole on the bottom of the camera. It serves both as a hand-held or fixed device.

Fix to use tripod



Hold to use tripod



ACV-8305W Quick start guide

Play panoramic video or picture

Note: The videos or pictures may be played in right panoramic effect only on smart mobile phone, panel computer or PC procedures.

1. Use mobile phone or panel computer to play

Follow these steps to play panoramic videos or pictures on mobile phone or tablet.

Download APP:

Search for “Denver 360° action camera” on App Store or Google Playstore to download and install the product APP.



Connect mobile phone and camera: Connect mobile phone and camera through WIFI connection

ACV-8305W Quick start guide

- i. Turn on camera WIFI: Press camera WIFI button, and the display screen will display “WI-FI ON”, and then “ACV8305_XXXX”, and initial password is “1234567890”.

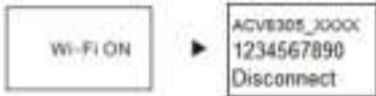

- ii. Turn on mobile phone WIFI, search for AP “ACV8305_XXXX” and select Connect.



hot

- iii. If connected, the camera display screen will display as below picture.



Activate APP: Activate “Denver 360° action camera” APP on mobile phone or

ACV-8305W Quick start guide
tablet, and click the upper right corner to “Search for Camera”.



Download: Enter camera folder, select the file to be downloaded and click to download.



Play: Select the file on mobile phone and click to play.



ACV-8305W Quick start guide

Important

It is recommended to follow the above steps in order to achieve the best HD video or picture playing effect.

Before connection, remember to make sure the SD card properly inserted into camera.

After connection, it will not affect 4G communication function of mobile phone or tablet .

Share:

Videos can be merged and shared after downloading from camera to mobile device, such as smart phone, tablet and etc.

ACV-8305W Quick start guide



Click “START TO SHARE”, videos shall start to merge together, after merging, videos can be shared via Youtube, Facebook, Wechat, QQ and etc. The sharing videos can be searched on its relevant websites or webpages.

Notice: The merged video file is in .mp4 format.

ACV-8305W Quick start guide

Effect of panoramic playing

The following effects are available if played on APP player

Tiny planet mode



ACV-8305W Quick start guide

Fisheye mode



Plane mode



VR mode



ACV-8305W Quick start guide

2. Use PC or notebook to play

You may use your PC to acquire a better playing experience, or edit/share videos. It can be completed by following the steps as shown below:

Download and install player: Open PC filemanager and install the Player in the CD ROM, or just go

visit <http://www.denver-electronics.com/pc-software-for-denver-acv-8305w/> to download and install Denver 360° action camera Player.

Remind: If dialog box as below image appears during the installation process, please choose YES and continue the installation.

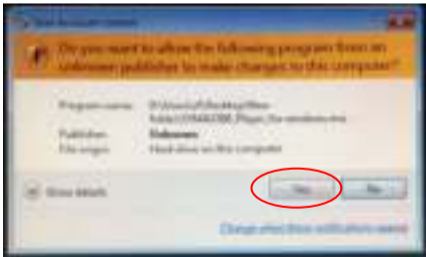

Download video or picture onto PC:

ACV-8305W Quick start guide

- Use the USB data cable attached to this product to connect the camera and PC. After connection, the camera display screen will display “MSDC”.



- Open “My computer” to select “VIDEO” OR “JPG” folder under “Removable disks”. Select file to be downloaded and download it into location specified on PC.

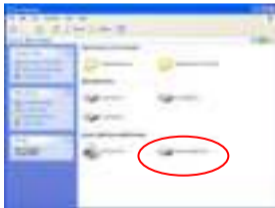

ACV-8305W Quick start guide

Run player: Open the video or picture downloaded and stored on PC in the player.



Playback video with player



Click the icon, choose the video which you want to play.

ACV-8305W Quick start guide



When playing the video, move the mouse to top right cone, it will show some different mode(Plane/Planet/Invert). Clip it and will show different effects. Please clip and move the mouse, you could enjoy the video with full angle 360 degree.

ACV-8305W Quick start guide

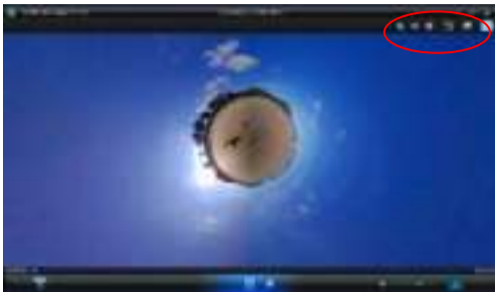

Edit and share video:

The video and photo which are recorded by this device could be edited and shared, as above picture, it could be shared to YouTube, Facebook and some other popular social website.

ACV-8305W Quick start guide



ENG 21

ACV-8305W Quick start guide

Important:

On current video websites, the videos uploaded by users have been compressed automatically. This may lead to different video play effects between website and local videos.

Technological parameters:

Image sensor	4.0M (CMOS)×2
Functional mode	Video & photo
Lens	F2.0 f=1.1mm
Video resolution	1920*960 (30fps)
Picture resolution	3008*1504
File format	Video H.264 (MOV) Image JPG
Storage medium	MICRO SD card (supportive 32GB at most)
USB interface	High-speed USB2.0 interface
Power supply	Built-in high voltage lithium battery 1500mAh
Size	60.4*49.8*47.8mm

Instructions for use

ACV-8305W Quick start guide

- The product is equipped with a built-in battery. Do not put it directly into fire, or it may cause explosion or other dangers.
- The product may radiate heat due to long-time use or exposure to direct sunlight. This is normal.
- If the camera stops working or fails to respond to any operation during use, use a needle to press and hold Reset button for about 3 seconds to restart the product.
- Do not use the camera under any environment with temperature lower than 0°C or higher than 40°C; or else it may not turn on normally.
- Do not use the camera in humid place, for the humidity may damage important parts of the camera.
- Do not put the camera directly into water.
- Do not use the camera during charging, for it may cause system halt or other failure due to improper heat radiation.
- Do not contact the lens with hard articles to avoid any damage.

Thank you again for purchasing this product. Have fun with it!

ACV-8305W Quick start guide
ALL RIGHTS RESERVED, COPYRIGHT DENVER ELECTRONICS A/S

DENVER®

www.denver-electronics.com



Electric and electronic equipment and included batteries contains materials, components and substances that can be hazardous to your health and the environment, if the waste material (discarded electric and electronic equipment and batteries) is not handled correctly.

ACV-8305W Quick start guide

Electric and electronic equipment and batteries is marked with the crossed out trash can symbol, seen below. This symbol signifies that electric and electronic equipment and batteries should not be disposed of with other household waste, but should be disposed of separately.

As the end user it is important that you submit your used batteries to the appropriate and designated facility. In this manner you make sure that the batteries are recycled in accordance with legislature and will not harm the environment.

All cities have established collection points, where electric and electronic equipment and batteries can either be submitted free of charge at recycling stations and other collection sites, or be collected from the households. Additional information is available at the technical department of your city.

Imported by:
DENVER ELECTRONICS A/S
Omega 5A Soeften
DK-8382 Hinnerup
Denmark

ACV-8305W Quick start guide

www.facebook.com/denverelectronics

Hereby, Inter Sales A/S, declares that this product (ACV-8305W) is in compliance with the essential requirements and other relevant provisions of Directive 2014/53/EU. A copy of the Declaration of conformity may be obtained at:

Inter Sales A/S
Omega 5A Soeften
DK-8382 Hinnerup
Denmark

