

AXC35 AXC25
COMPACT DISC PLAYER

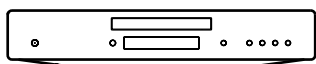

Contents

IMPORTANT SAFETY INSTRUCTIONS	3
REAR PANEL CONNECTIONS	5
FRONT PANEL CONTROLS	5
REMOTE CONTROL	6
OPERATING INSTRUCTIONS	7
TECHNICAL SPECIFICATIONS	8
TROUBLESHOOTING	9

This guide is designed to make installing and using this product as easy as possible. Information in this document has been carefully checked for accuracy at the time of printing; however, Cambridge Audio's policy is one of continuous improvement, therefore design and specifications are subject to change without prior notice.

This document contains proprietary information protected by copyright. All rights are reserved. No part of this manual may be reproduced by any mechanical, electronic or other means, in any form, without prior written permission of the manufacturer. All trademarks and registered trademarks are the property of their respective owners.

© Copyright Cambridge Audio Ltd 2019.

Make sure you register your product at:
WWW.CAMBRIDGEAUDIO.COM/REGISTER

For upcoming news on future products, software updates and exclusive offers.

Important safety instructions

For your own safety please read the following important safety instructions carefully before attempting to connect this unit to the mains power supply. They will also enable you to get the best performance from and prolong the life of the unit:

1. Read these instructions.
2. Keep these instructions.
3. Heed all warnings.
4. Follow all instructions.
5. Do not use this apparatus near water.
6. Clean only with a dry cloth.
7. Do not block any ventilation openings. Install in accordance with the manufacturer's instructions.
8. Do not install near any heat sources such as radiators, heat registers, stoves, or other apparatus (including amplifiers) that produce heat.
9. Do not defeat the safety purpose of the polarized or grounding-type plug. A polarized plug has two blades with one wider than the other. A grounding-type plug has two blades and a third grounding prong. The wide blade or the third prong are provided for your safety. If the provided plug does not fit into your outlet, consult an electrician for replacement of the obsolete outlet.
10. Protect the power cord from being walked on or pinched, particularly at plugs, convenience receptacles and the point where they exit from the apparatus.
11. Only use attachments/accessories specified by the manufacturer.
12. Use with only the cart, stand, tripod, bracket, or table specified by the manufacturer, or sold with the apparatus. When a cart is used, use caution when moving the cart/ apparatus combination to avoid injury from tip-over. 
13. Unplug this apparatus during lightning storms or when unused for long periods of time.
14. Refer all servicing to qualified service personnel. Servicing is required when the apparatus has been damaged in any way, such as the power-supply cord or plug having been damaged, liquid has been spilled or objects have fallen into the apparatus, the apparatus has been exposed to rain or moisture, does not operate normally, or has been dropped.

WARNING:

- Do not place the unit in an enclosed space; if you wish to place the unit on a shelf, use the top shelf to allow maximum ventilation. Do not put any objects on top of this unit. Do not situate it on a rug or other soft surface and do not obstruct any air inlets or outlet grilles. Do not cover the ventilation grilles with items such as newspapers, tablecloths, curtains, etc.
- To reduce the risk of fire or electric shock, do not expose this apparatus to rain or moisture. This unit must not be used near water or exposed to dripping or splashing water or other liquids. No objects filled with liquid, such as vases, shall be placed on the unit.
- Danger of explosion if battery is incorrectly replaced. Replace only with the same or equivalent type.
- The battery (battery pack or batteries installed) shall not be exposed to excessive heat such as sunshine, fire or the like.
- The unit must be installed in a manner that makes disconnection of the mains plug from the mains socket outlet (or appliance connector from the rear of the unit) possible. Where the mains plug is used as the disconnect device, the disconnect device shall remain readily operable.
- Please refer to the information on the exterior rear panel for electrical and safety information before installing or operating the apparatus.
- Only use the mains cord supplied with this unit.

Use of the apparatus in tropical climates - The equipment shall be used at a maximum 45 degree C ambient temperature.



The lightning flash with the arrowhead symbol within an equilateral triangle is intended to alert the user to the presence of un-insulated 'dangerous voltage' within the product's enclosure that may be of sufficient magnitude to constitute a risk of electric shock to persons.

The exclamation point within an equilateral triangle is intended to alert the user to the presence of important operating and maintenance instructions in the service literature relevant to this appliance.

The exclamation point within an equilateral triangle is intended to alert the user to the presence of important operating and maintenance instructions in the service literature relevant to this appliance.



The symbol on this product indicates that it is of CLASS II (double insulated) construction.



WEEE SYMBOL

The crossed-out wheeled bin is the European Union symbol for indicating separate collection for electrical and electronic equipment. This product contains electrical and electronic equipment which should be reused, recycled or recovered and should not be disposed of with unsorted regular waste. Please return the unit or contact the authorised dealer from whom you purchased this product for more information.



CE MARK

This product complies with European Low Voltage (2014/35/EU), Electromagnetic Compatibility (2014/30/EU) and Environmentally-friendly design of Energy-related Products (2009/125/EC) Directives when used and installed according to this instruction manual. For continued compliance only Cambridge Audio accessories should be used with this product and servicing must be referred to qualified service personnel.



RCM (REGULATORY COMPLIANCE MARK)

This product meets Australia, New Zealand Safety, EMC and Radio Communications requirements of the ERAC and ACMA.

FEDERAL COMMUNICATIONS COMMISSION NOTICE:

This equipment has been tested and found to comply with the limits for a Class B digital device, pursuant to Part 15 of the FCC Rules. These limits are designed to provide reasonable protection against harmful interference in a residential installation.

This equipment generates, uses, and can radiate radio frequency energy, and if not installed and used in accordance with the instructions, may cause harmful interference to radio communications. However, there is no guarantee that interference will not occur in a particular installation.

If this equipment does cause harmful interference to radio or television reception, which can be determined by turning the equipment off and on, the user is encouraged to try and correct the interference by one or more of the following measures:

- Reorient or relocate the receiving antenna.
- Increase the distance between the equipment and the receiver.
- Connect the equipment to an outlet on a circuit different from that to which the receiver is connected.
- Consult the dealer or an experienced radio/TV technician for help.

FCC Caution: Any changes or modifications not expressly approved by the party responsible for compliance could void the user's authority to operate this equipment.



SUPPLIER'S DECLARATION OF CONFORMITY (SDOC)

Equipment: Compact Disc Player
Model(s): AXC35, AXC25
Trademark: Cambridge Audio

This device complies with Part 15 of the FCC Rules. Operation is subject to the following two conditions: (1) this device may not cause harmful interference, and (2) this device must accept any interference received, including interference that may cause undesired operation.

The responsible party in US:

Company name: Audio Partnership LLC

Address: 1913 N Milwaukee Ave. Chicago, IL 60647

Phone: (312) 636-4817

Legal Representative Person: Gregg Chopper

Signature:

A handwritten signature in black ink, appearing to read "Gregg Chopper", written over a light blue horizontal line.

VENTILATION

Important! The unit will become hot when in use. Do not stack multiple units on top of each other.

Ensure that small objects do not fall through any ventilation grille. If this happens, switch off immediately, disconnect from the mains supply and contact your dealer for advice.

POSITIONING

Choose the installation location carefully. Avoid placing it in direct sunlight or close to a source of heat. No naked flame sources, such as lighted candles, should be placed on the unit. Also avoid locations subject to vibration and excessive dust, cold or moisture. The unit can be used in a moderate climate.

This unit must be installed on a sturdy, level surface. Do not place in a sealed area such as a bookcase or in a cabinet. Do not place the unit on an unstable surface or shelf. The unit may fall, causing serious injury to a child or adult as well as serious damage to the product. Do not place other equipment on top of the unit.

Due to stray magnetic fields, turntables or CRT TVs should not be located nearby due to possible interference.

Electronic audio components have a running in period of around a week (if used several hours per day). This will allow the new components to settle down and the sonic properties will improve over this time.

POWER SOURCES

The unit should be operated only from the type of power source indicated on the marking label. If you are not sure of the type of power-supply to your home, consult your product dealer or local power company.

If you do not intend to use this unit for a long period of time, unplug it from the mains socket.

OVERLOADING

Do not overload wall outlets or extension cords as this can result in a risk of fire or electric shock. Overloaded AC outlets, extension cords, frayed power cords, damaged or cracked wire insulation and broken plugs are dangerous. They may result in a shock or fire hazard.

Be sure to insert each power cord securely. To prevent hum and noise, do not bundle the interconnect leads with the power cord or speaker leads.

CLEANING

To clean the unit, wipe its case with a dry, lint-free cloth. Do not use any cleaning fluids containing alcohol, ammonia or abrasives. Do not spray an aerosol at or near the unit.

BATTERY DISPOSAL

Batteries may contain substances harmful to the environment. Please dispose of any discharged batteries with due consideration and in accordance with local environmental/electronic recycling guidelines.

SERVICING

These units are not user serviceable. Never attempt to repair, disassemble or reconstruct the unit if there seems to be a problem. A serious electric shock could result if this precautionary measure is ignored. In the event of a problem or failure, please contact your dealer.

Rear panel connections

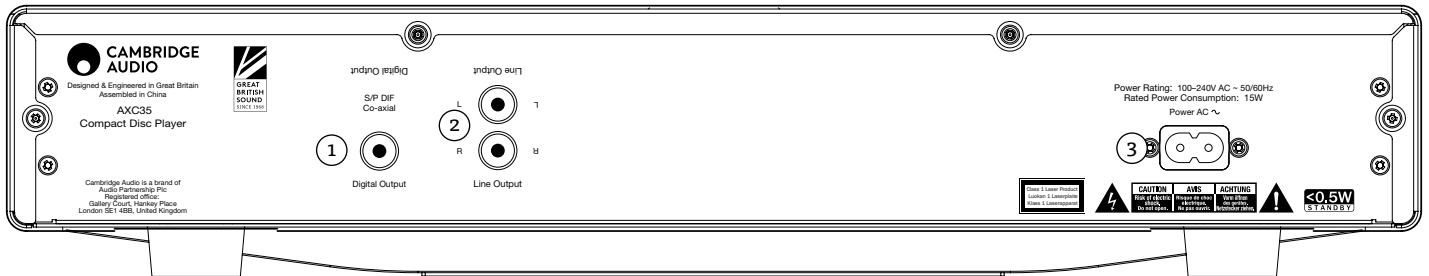

① S/P DIF CO-AXIAL DIGITAL OUTPUT (AXC35 ONLY)

For input to a separate DAC or digital recording machine. To obtain best results, use a high quality 75ohm digital RCA interconnect cable (not one designed for normal audio use).

② LINE OUTPUT

Use good quality interconnect cables from these sockets to any line level input on your amplifier. For best results and matched performance, we recommend connection to a Cambridge Audio amplifier.

③ AC POWER CABLE

Once you have completed all connections to the amplifier, plug the AC power cable into an appropriate mains socket and turn the unit on. Your compact disc player is now ready for use.

Front panel controls

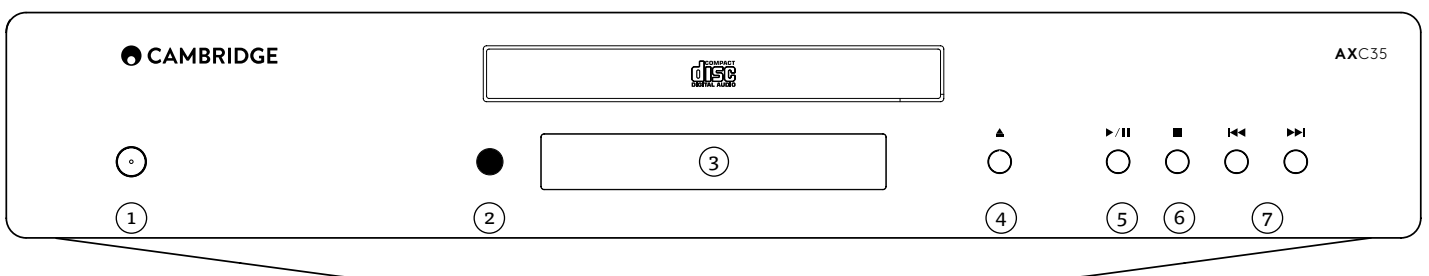

① POWER BUTTON

Switches the unit between Standby mode (indicated by dim power LED) and On (indicated by bright power LED). Standby mode is a low power mode where the power consumption is less than 0.5 Watts. This product has APD (Auto Power Down) enabled as default. After inactivity of 20 minutes, the product will automatically switch to Standby.

Auto Power Down (APD)

You can enable and disable the units APD setting. This can be adjusted by pressing and holding the Power button until the LED flashes in sequence.

The two options below show which option is selected.

Standby flashes 5 times - APD disabled

Standby flashes 10 times - APD enabled

Note: Make sure the unit is On, before making changes to the APD function.

② INFRARED SENSOR

Receives IR commands from the supplied remote control. An unobstructed line of sight between the remote control and the sensor is required.

③ DISPLAY

Alpha-numeric characters which display playback information. On inserting a disc, the CD player will take a few seconds to read the Table of Contents (TOC) information from the disc. The display will then show the number of tracks on the CD and the total length of the CD.

④ OPEN/CLOSE

Allows you to open and close the disc tray. After placing a CD in the tray, press Open/Close to close the tray.

⑤ PLAY/PAUSE

Plays the disc and pauses play.

⑥ STOP

Stops the CD playing.

⑦ SKIP/SCAN

Enables you to skip between and search within tracks. Press briefly to skip a track. Press and hold to scan through a track.

Remote control

The AXC35 and AXC25 are supplied with a remote control that operates the unit. The supplied AAA batteries must be fitted before the remote control can be used.

POWER BUTTON

Switches the AXC35 /AXC25 between On and low power ecofriendly Standby mode.

OPEN/CLOSE

Opens and closes the disc tray.

NUMERICAL TRACK SELECT

Press the number of the desired track. The track will then play automatically from the start of the track.

PROG

Allows you to program a unique sequence of up to 20 tracks. Refer to 'Operating Instructions' section of this manual for more information.

PROG CLEAR

Clears a programmed sequence. See later section of this manual.

PAUSE/ ■ STOP/ ▶ PLAY

Press the relevant button to pause, stop or play the CD.

SKIP

Right Skip – Press to skip forward by one track on the CD.

Left Skip – Press to skip backward by one track on the CD.

SCAN

Press and hold to scan within the selected track. Press the right button to fast forward, the left button to rewind.

RANDOM, REPEAT, REMAIN

Read the 'Operating Instructions' section of this manual for information on the functions of these buttons.

AXA35

To operate AXA35 unit only.

VOLUME

Increases or decreases the volume of the unit. Also used to change the bass, treble and balance settings when these are selected.

MENU

Toggles between Bass, Treble and Balance options. Use the volume buttons to change the level of the selected option.

SOURCE BUTTONS (CD, BD/DVD, MP3/AUX, TUNER, PHONO)

Press the relevant button to select the desired music source.

MUTES THE OUTPUT OF AN AXA35

Note: These controls work on the AXA35 only and are not compatible with Cambridge Audio Azur amplifiers/receivers or units from other manufacturers

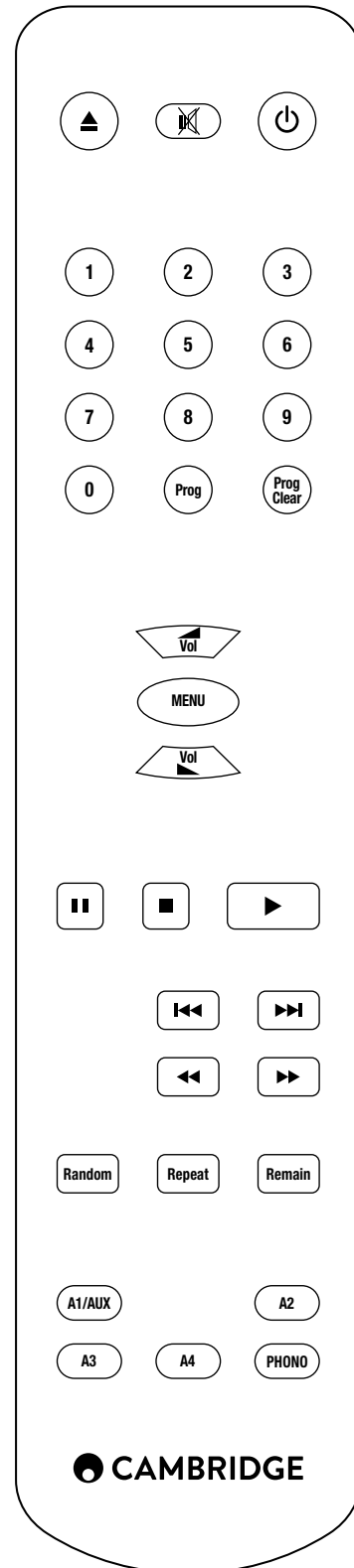

Operating instructions

LOADING AND UNLOADING DISCS

1. Press the Open/Close button.
2. When the disc tray has opened fully, place a disc carefully in the tray with the label side facing up.
3. To close the disc tray, press the Open/Close button again. When the tray, with a correctly loaded disc, is fully closed the CD player will read the disc and display the content information.
4. The disc tray can be opened at any time by pressing the Open/Close button. Only remove the disc after the tray has fully opened.

Note:

- Do not put anything except a compact disc into the tray. Foreign objects may damage the mechanism.
- Do not force the tray by hand during the opening and closing operations.
- To avoid dirt and dust entering the mechanism, keep the disc tray closed.
- If the compact disc is badly scratched or too dirty, the player may not be able to read it or play it.
- Never load more than one disc into the disc tray at any time.



NORMAL DISC PLAY

This unit has been designed to play compact discs, recordable CDs (CD-R) and re-writable CDs (CD-RW) bearing the identification logo shown here. No other discs can be used. The CD-R/CD-RW discs should contain properly recorded TOC (Table of Contents) information so that they can be played back. This unit can play only the discs recorded in the CDDA format designed for music reproduction or those containing MP3 or WMA files. Do not attempt to play a disc on this unit containing other data, such as a data CD-ROM for PCs.

1. Switch on your amplifier and set its input selector to the correct position. Adjust the volume control to a minimum.
2. Press the Open/Close button to open the disc tray and load a disc.
3. Press the Open/Close button again to close the tray. The CD player will read the disc.
4. To begin playback, press the ▶ button.
5. When the last track has finished playing, the display will return to Table of Contents (TOC).
6. To stop the disc at any point, press the ■ button. Pressing the || button while the disc is playing will pause the disc. Playback can be resumed by pressing ▶ button.

LOCATING A SPECIFIC TRACK DURING PLAYBACK

1. A single short press of the ►► button will take you to the beginning of the next track on the CD. Repeat as necessary.
2. A single short press of the ◀◀ button will take you to the beginning of the previous track.

LOCATING A SPECIFIC TRACK WHEN PLAYBACK IS STOPPED

1. A single short press of the ◀◀ ►► buttons will skip between tracks.
2. Press ▶ to start playback from the selected track.

REPEATING DISCS AND TRACKS

1. Ensure that the disc is loaded.
2. To repeat a specific track, press the Repeat button on the remote. 'RPT ONE' will appear on the display. Press ▶ and the selected track will now repeat until the function is turned off. Alternatively, press the Repeat button, select the chosen track using the numerical buttons on the remote control and press ▶.

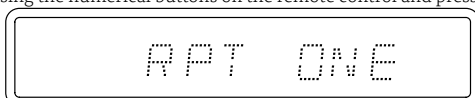

3. Press the Repeat button twice on the remote control. 'RPT ALL' will appear on the display. Press ▶. The whole disc will now be repeated until the function is turned off.

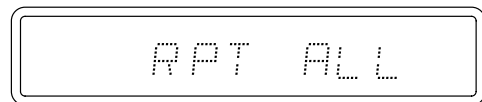

4. To turn the Repeat function off, press the Repeat button either before or during playback until 'RPT OFF' appear on the display.

PLAYING TRACKS IN RANDOM ORDER

1. Ensure that a disc is loaded.
2. Press the Random button on the remote control. 'RAN ON' will appear on the display.

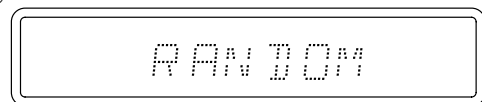

3. Press ▶. The CD player will now play the entire disc in random order. It is also possible to press the Random button during playback to listen to tracks in random order.
4. Press the Random button to exit. The disc will continue playing to the end in the correct order.

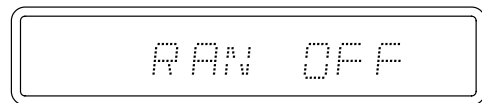

5. Press the ■ button at any time to stop the disc.

Note: Selecting 'Random' mode when 'RPT ONE' has been selected will automatically cancel 'RPT ONE' mode.

USING THE REMAIN FUNCTION

1. Ensure that the disc is playing.
2. Press the Remain button on the remote control once to display the time remaining for the track playing.
3. Pressing the Remain button the second time will show the total remaining disc time.
4. Press the Remain button again either before or during playback to return to normal play mode.

PROGRAMMING DISC PLAY

It is possible to program the AXC35/AXC25 to play back in any order only the tracks you wish to listen to.

1. Ensure that a disc is loaded. The display should show the TOC data.
2. Press the Prog button on the remote control. The Program set-up will appear on the display.

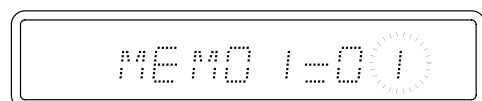

3. Use the ◀◀ ►► buttons or enter the track number that you want to program as your first track.
4. Press the Prog button on the remote. The desired track is now programmed. The program number automatically increases by one for the next entry.

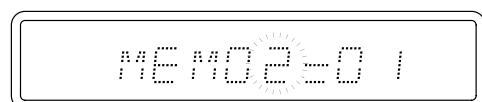

5. Repeat steps three and four until all your desired tracks are entered. A maximum of 20 tracks can be programmed.
6. Press the ▶ button to begin programmed playback.
7. Press the Prog Clear button on the remote to clear all programmed tracks.

Technical specifications

AXC25

D/A Converter	Wolfson Microelectronics WM8524
Filter	2 -pole Butterworth filter
Frequency response (+/-0.4dB)	20Hz - 20kHz
THD @ 1Khz odBFs	<0.006%
THD @ 1Khz -10dBfs	<0.015%
S/N ratio, A weighted	>93dB
Crosstalk @1kHz	<-95dB
Crosstalk @20kHz	<-95dB
Output impedance	<50 ohms
Gapless Playback	Yes
Maximum power consumption	15W
Standby power consumption	<0.5W
Dimensions	75 x 430 x 305mm (3.0 x 16.9 x 12.2")
Weight	4.3kg (9.5lbs)

AXC35

D/A Converter	Wolfson Microelectronics WM8524
Filter	2 -pole Butterworth filter
Frequency response (+/-0.4dB)	20Hz - 20kHz
THD @ 1Khz odBFs	<0.006%
THD @ 1Khz -10dBfs	<0.01%
S/N ratio, A weighted	>95dB
Crosstalk @1kHz	<-98dB
Crosstalk @20kHz	<-95dB
Output impedance	<50 ohms
S/PDIF output impedance	<75 ohms
Gapless Playback	Yes
Maximum power consumption	15W
Standby power consumption	<0.5W
Dimensions	75 x 430 x 305mm (3.0 x 16.9 x 12.2")
Weight	4.3kg (9.5lbs)

Troubleshooting

THERE IS NO POWER

Ensure the AC power cord is connected securely.
Ensure the plug is fully inserted into the wall socket and is switched on.
Check fuse in the mains plug or adaptor.

THE PLAYER WILL NOT READ THE DISC

Check the disc is not loaded upside down.
Check that the disc is not too scratched or dirty.

THERE IS NO SOUND

Ensure that the amplifier is set correctly.
Check that the interconnects are inserted correctly.

THE DISC IS SKIPPING

Check that the disc is not too scratched or dirty.
Ensure the player is on a firm surface and not subject to vibrations.

THERE IS A HUM COMING FROM THE SPEAKER

Ensure that all cable connections are secure.

THE REMOTE HANDSET WILL NOT FUNCTION

Check that the batteries have not expired.
Ensure that nothing is blocking the remote sensor.

If you experience any trouble with your product, visit the help section on our webpage at <https://techsupport.cambridgeaudio.com>

For all servicing, in or out of warranty, please contact your dealer.

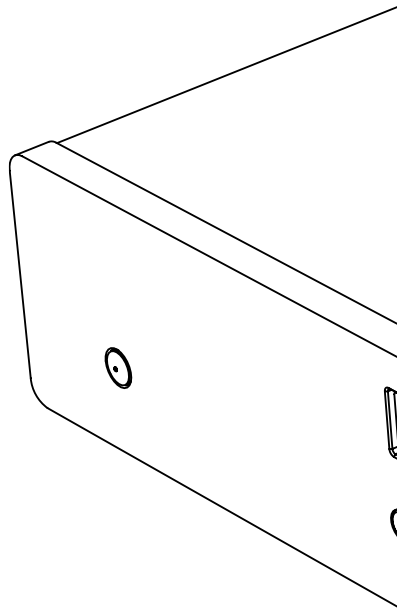

WWW.CAMBRIDGEAUDIO.COM

Gallery Court, Hankey Place
London
SE1 4BB
United Kingdom

Cambridge Audio is a brand of Audio Partnership Plc.
Registered in England No. 2953313

AP36643/1