

SONY®

Home Audio System

Operating Instructions

Getting Started

USB Device

BLUETOOTH connection

Sound Adjustment

Other Operations

Additional Information

WARNING

To reduce the risk of fire, do not cover the ventilation opening of the appliance with newspapers, tablecloths, curtains, etc. Do not expose the appliance to naked flame sources (for example, lighted candles).

To reduce the risk of fire or electric shock, do not expose this appliance to dripping or splashing, and do not place objects filled with liquids, such as vases, on the appliance.

As the main plug is used to disconnect the unit from the mains, connect the unit to an easily accessible AC outlet. Should you notice an abnormality in the unit, disconnect the main plug from the AC outlet immediately.

Do not install the appliance in a confined space, such as a bookcase or built-in cabinet.

Do not expose batteries or appliances with battery-installed to excessive heat, such as sunshine and fire.

Do not dismantle, open or shred secondary cells or batteries.

In the event of a cell leaking, do not allow the liquid to come in contact with the skin or eyes. If contact has been made, wash the affected area with copious amounts of water and seek medical advice.

Do not use any charger other than that specifically provided for use with the equipment.

Secondary cells and batteries need to be charged before use. Always use the correct charger and refer to the manufacturer's instructions or equipment manual for proper charging instructions.

After extended periods of storage, it may be necessary to charge and discharge the cells or batteries several times to obtain maximum performance.

Dispose of properly.

The unit is not disconnected from the mains as long as it is connected to the AC outlet, even if the unit itself has been turned off.

Indoor use only.

For customers in Europe

Disposal of waste batteries and electrical and electronic equipment (applicable in the European Union and other European countries with separate collection systems)



This symbol on the product, the battery or on the packaging indicates that the product and the battery shall not be treated as household waste. On certain batteries

this symbol might be used in combination with a chemical symbol. The chemical symbols for mercury (Hg) or lead (Pb) are added if the battery contains more than 0.0005% mercury or 0.004% lead. By ensuring these products and batteries are disposed of correctly, you will help prevent potentially negative consequences for the environment and human health which could otherwise be caused by inappropriate waste handling. The recycling of the materials will help to conserve natural resources.

In case of products that for safety, performance or data integrity reasons require a permanent connection with an incorporated battery, this battery should be replaced by qualified service staff only. To ensure that the battery and the electrical and electronic equipment will be treated properly, hand over these products at end-of-life to the applicable collection point for the recycling of electrical and electronic equipment. For all other batteries, please view the section on how to remove the battery from the product safely. Hand the battery over to the applicable collection point for the recycling of waste batteries. For more detailed information about recycling of this product or battery, please contact your local Civic Office, your household waste disposal service or the shop where you purchased the product or battery.

Notice for customers: the following information is only applicable to equipment sold in countries applying EU directives.

This product has been manufactured by or on behalf of Sony Corporation, 1-7-1 Konan Minato-ku Tokyo, 108-0075 Japan. Inquiries related to product compliance based on European Union legislation shall be addressed to the authorized representative, Sony Belgium, bijkantoor van Sony Europe Limited, Davincilaan 7-D1, 1935 Zaventem, Belgium. For any service or guarantee matters, please refer to the addresses provided in the separate service or guarantee documents.

Hereby, Sony Corporation declares that this equipment is in compliance with Directive 2014/53/EU.

The full text of the EU declaration of conformity is available at the following internet address:

<http://www.compliance.sony.de/>



The validity of the CE marking is restricted to only those countries where it is legally enforced, mainly in the countries EEA (European Economic Area).

This equipment has been tested and found to comply with the limits set out in the EMC Directive using a connection cable shorter than 3 meters.

For customers in Australia



Disposal of Old Electrical & Electronic Equipment (Applicable in the European Union and other European countries with separate collection systems)

This system is designed to be used for the following purposes:

- Playing back music sources on USB devices or BLUETOOTH devices
- Enjoying social gatherings with the “Party Chain” or speaker add function

About this manual

- Some illustrations are presented as conceptual drawings, and may be different from the actual products.
- The instructions in this manual are for models GTK-XB60 and GTK-XB90. The GTK-XB60 is used for illustrative purposes unless otherwise noted.

Table of Contents

About this manual..... 4
Guide to parts and controls 6

Getting Started

Turning on the system 10
Carrying the system 10
Placing the system
horizontally 11
About the power
management..... 11
Charging the battery 11

USB Device

Before using the USB device13
Playing a file13

BLUETOOTH connection

Pairing this system with a
BLUETOOTH device.....15
One Touch BLUETOOTH
Connection by NFC17
Listening to music on a
BLUETOOTH device..... 18
About the BLUETOOTH
wireless technology.....20
Playing back with high quality
sound codec (AAC/LDAC™)20
Setting the BLUETOOTH
standby mode21
Turning on or off the
BLUETOOTH signal.....21
Using “Sony | Music Center”
and “Fiestable” via
BLUETOOTH connection 22

Sound Adjustment

Adjusting the sound 23

Other Operations

Enjoying wired playback using
multiple systems (Wired Party
Chain function) 24
Enjoying wireless playback
using multiple systems
(Wireless Party Chain
function) 27
Listening to music wirelessly
with two systems (Speaker
add function)28
Enjoying music with the
Speaker Lights30
Enjoying hands-free calls31
Using an optional
equipment 32
Using an optional
microphone 32
Setting the automatic
standby function 33
Saving the battery power..... 33

Additional Information

Information about
compatible devices 34
Troubleshooting 34
Precautions 38
Specifications.....40
License and Trademark
Notice..... 42

Guide to parts and controls

GTK-XB60

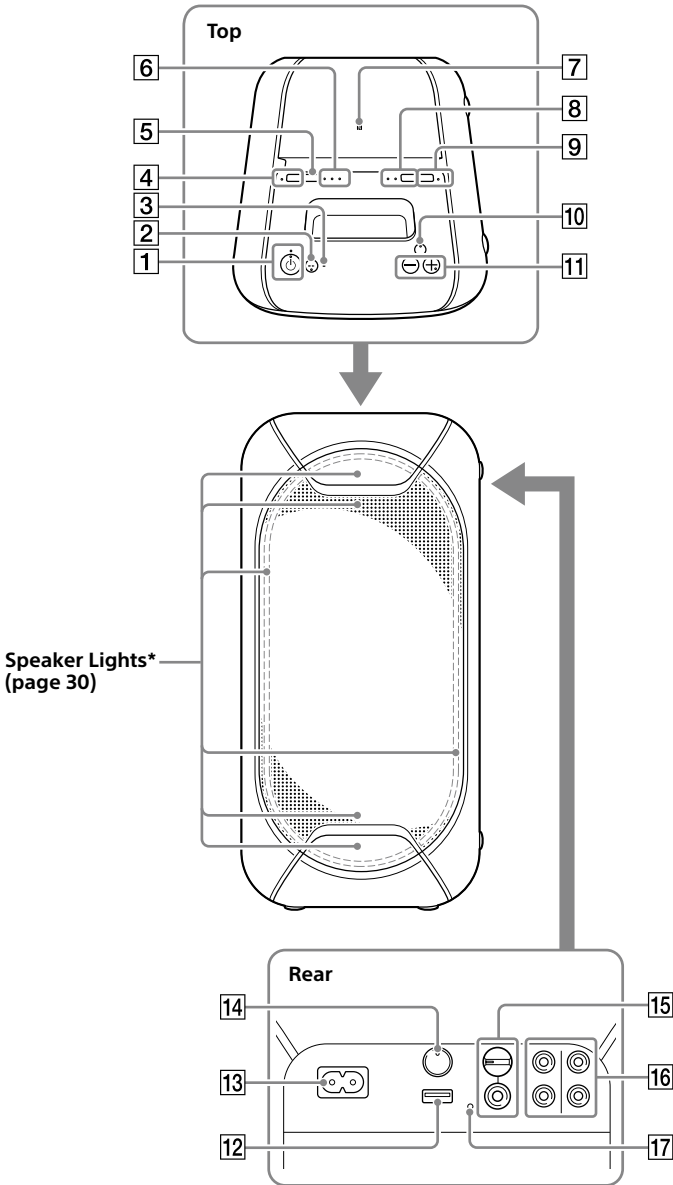

* Do not look directly at the light-emitting parts when the Speaker Lights are turned on.

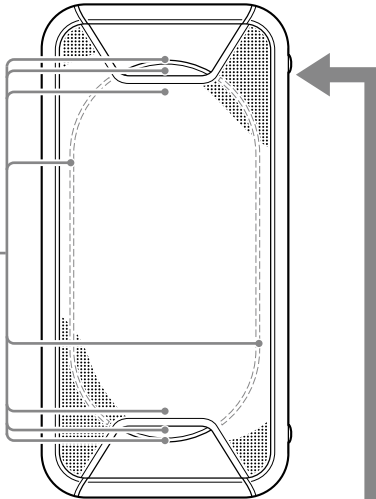
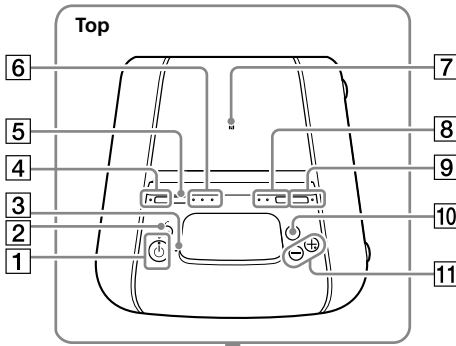

Speaker Lights*
(page 30)

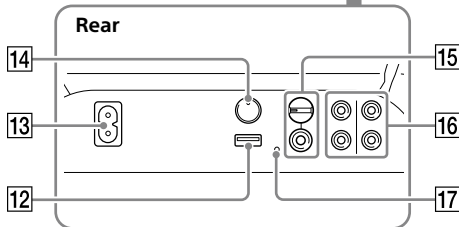

* Do not look directly at the light-emitting parts when the Speaker Lights are turned on.



- 1**  **(power) button**
Press to turn on or off the system.

 (power) indicator

- Lights up in green while the system is turned on.
- Lights up in amber while the system is turned off, and when the BLUETOOTH standby mode is turned on.

CHARGE indicator (page 11)

Lights up in amber while the battery is charging.

- 2**  **(play/pause)/ (call)* button**
- Press to play/pause music.
 - Press to receive/end a call when using the hands-free call function with your BLUETOOTH-connected mobile phone (page 31).

- 3** **Built-in microphone**

- 4** **STAMINA – BATTERY button**
- Press to turn on the power-saving mode (STAMINA mode) when using the built-in battery (page 33).
 - Hold down to check the remaining battery level (page 12).

STAMINA – BATTERY indicator

Lights up while STAMINA mode is active (page 33).

- 5** **FUNCTION – PAIRING button**
- Press repeatedly to select the BLUETOOTH, USB or Audio In function.
 - When the BLUETOOTH function is selected, hold down to activate BLUETOOTH pairing.
 - Press to stop the built-in sound demonstration.

- 6**  **(BLUETOOTH) indicator**
(page 20)

USB indicator (page 13)

AUDIO IN indicator (page 32)

- 7**  **(N-Mark) (page 17)**

- 8** **ADD button (page 28)**

ADD L/R indicators (page 28)

- 9** **W.PARTY CHAIN – LIGHT button**
- Press to turn the Wireless Party Chain function on (page 27).
 - Hold down for more than 3 seconds to turn the speaker lights on/off (page 30).

W.PARTY CHAIN – LIGHT indicator

Lights up when the Wireless Party Chain function is in use (page 27).

- 10** **EXTRA BASS button**

- Press to generate more dynamic sound (page 23).
- Hold down for more than 3 seconds while the AC power cord is connected to play back the built-in sound demonstration.

EXTRA BASS indicator

Lights up when the EXTRA BASS function is turned on (page 23).

- 11** **Volume +/- buttons**
Press to adjust the volume.

- 12**  **(USB) port**
Use to connect a USB device.

- 13** **AC IN jack (page 10)**

- 14** **PARTY CHAIN button (page 26)**

PARTY CHAIN indicator
(page 26)

- 15** **MIC jack (page 32)**

MIC LEVEL (MIN/MAX) knob
(page 32)

16 Audio output and input jacks

Use an audio cord (not supplied) to make either connection as follows:



- **AUDIO/PARTY CHAIN OUT L/R jacks**
 - Connect to the audio input jacks of an optional equipment.
 - Connect to another audio system to enjoy the Wired Party Chain function (page 24).
- **AUDIO/PARTY CHAIN IN L/R jacks**
 - Connect to the audio output jacks of a TV or an audio/video equipment. The sound is output through this system.
 - Connect to another audio system to enjoy the Wired Party Chain function (page 24).

17 RESET button

- * The  button and the volume + button have a tactile dot. Use the tactile dot as a reference when operating the system.

Indicator statuses

The statuses of the indicators on the unit are shown in the illustrations as follows.

Indicator status	Illustration
Flashing	
Lit up	
Turned off	

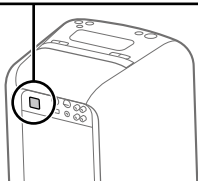
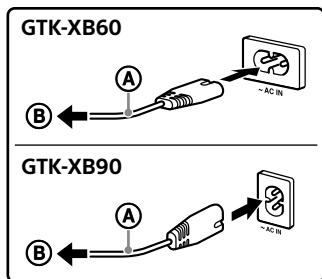

Turning on the system

- 1 Connect the AC power cord (supplied) to the AC IN jack on the rear of the unit, and then to the wall outlet.



- A AC power cord (supplied)
- B To wall outlet

The system is turned on in the demonstration mode and the demonstration starts automatically.

- 2 Press  to turn on the system.
The  indicator lights up in green.

Hint

The system can be used with the built-in battery instead of connecting the AC power cord (supplied) to a wall outlet if you have charged the battery before use. For details, see "Charging the battery" (page 11).

Deactivating the demonstration

Hold down **W.PARTY CHAIN – LIGHT** for more than 3 seconds while the demonstration is performed.

The demonstration ends and the system enters the standby mode. When you hold down **W.PARTY CHAIN – LIGHT** during the standby mode, or when you disconnect and reconnect the AC power cord, the system enters the demonstration mode.

Carrying the system

Before carrying the system, disconnect all the cords.

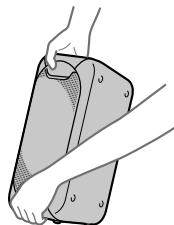

Note

Correct hand placement while carrying the system is very important to avoid personal injury and/or property damage.

Placing the system horizontally

You can also place the system horizontally as illustrated below. (Place the rubber feet side down.)

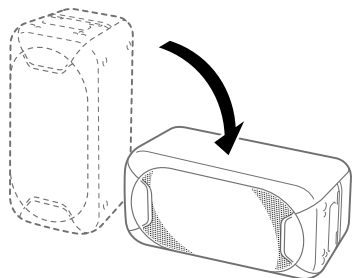

Hint

When you change the orientation of the system, the tweeters that output sound for the left and right channels are switched to the upper two units automatically (for GTK-XB90 only).

About the power management

- By default, this system is set to turn off automatically in about 15 minutes when there is no operation, and no audio signal is detected. For details, see "Setting the automatic standby function" (page 33).
- You can reduce the power consumption using STAMINA mode. For details, see "Saving the battery power" (page 33).

Charging the battery

The system can be used with the built-in battery (rechargeable) instead of connecting the AC power cord to a wall outlet if the battery has been sufficiently charged.

Connect the AC power cord (supplied) to the AC IN jack on the rear of the unit, and then to the wall outlet.

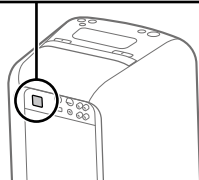
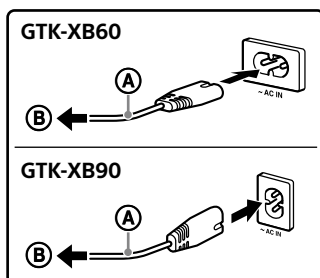

- Ⓐ AC power cord (supplied)
- Ⓑ To wall outlet

The CHARGE indicator will light up in amber. Charging will be completed in about 4 hours and the indicator will turn off.

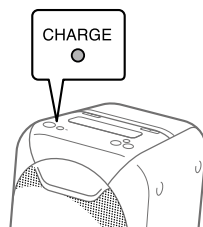

Notes

- It may take longer to charge the battery depending on the conditions of use.
- Even if you do not intend to use the system for a long time, charge the battery to its full capacity once every six months to maintain its performance.
- In an extremely cold or hot environment, charging stops for safety. If charging is taking a long time, this also stops the system from charging. In these conditions, the CHARGE indicator continues to flash quickly in amber, but this is not a malfunction. To resolve these issues, disconnect the AC power cord and connect it again in an operating temperature between 5°C and 35°C (41°F and 95°F).

Hint

You can operate the system while it is charging.

Checking the battery level of the rechargeable battery

You can check the remaining battery level via voice guidance.

You can also check the battery level using “Sony | Music Center” (page 22).

- 1 Press  to turn on the system.
- 2 Hold down **STAMINA – BATTERY**.

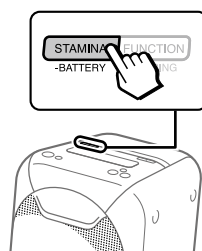

- 3 The voice guidance message is heard and the **CHARGE** indicator flashes as follows according to the remaining battery level.

Message (battery level)	Indicator flashes
“Fully charged” (80% – 100%)	4 times
“About 70%” (60% – 79%)	3 times
“About 50%” (30% – 59%)	2 times
“About 20%” (11% – 29%)	Once
“Please charge” (less than 10%)	Continuously

Hint

“Please charge” is output automatically when the remaining battery level is less than 10%.

Before using the USB device

For compatible USB devices, see “Information about compatible devices” (page 34).

When using Apple devices with this system, connect them via a BLUETOOTH connection (page 15). Using Apple devices via a USB connection is not supported.

Notes

- When USB cable connection is necessary, use the USB cable supplied with the USB device. See the operating instructions supplied with the USB device for details on the operation method.
- Do not connect the system and the USB device through a USB hub.
- When the USB device is connected, the system reads all the files on the USB device. If there are many folders or files on the USB device, it may take a long time to finish reading the USB device.
- With some connected USB devices, there may be a delay before an operation is performed by this system.
- Compatibility with all encoding/writing software cannot be guaranteed. If audio files on the USB device were originally encoded with incompatible software, those files may produce noise or interrupted audio, or may not play at all.
- This system does not necessarily support all the functions provided in a connected USB device.

To use the system as a battery charger

You can use the system as a battery charger for USB devices that have a rechargeable function.

Connect the USB device to the ψ (USB) port.

The charging begins when the USB device is connected to the ψ (USB) port. For details, refer to the operating instructions of your USB device.

Playing a file

The following audio file formats are supported:

- MP3: file extension “.mp3”
- WMA: file extension “.wma”

- 1 Press FUNCTION – PAIRING repeatedly until the USB indicator on the unit lights up.**
- 2 Connect the USB device to the ψ (USB) port.**
- 3 Press \blacktriangleright ||/↶ to start playback.**
You can control playback operations and select music easily from a list of music on the USB device using “Sony | Music Center” (page 22).
- 4 Press the volume +/- buttons to adjust the volume.**

Other operations

To	Do this
Pause playback	Press ► /↺. To resume play, press ► /↺ again.
Play back the next song	Press ► /↺ twice.
Play back the previous song	Press ► /↻ for three times.

Notes

- This system cannot play audio files on the USB device in the following cases;
 - when the total number of audio files on a USB device exceeds 999.
 - when the number of folders on a USB device exceeds 75 (including the "ROOT" folder and empty folders).These numbers may vary depending on the file and folder structure. Do not save other types of files or unnecessary folders on a USB device that has audio files.
- The system can play back to a depth of 8 folders only.
- Folders that have no audio files are skipped.
- Note that even when the file name has the correct file extension, if the actual file differs, the system may emit noise or malfunction.

BLUETOOTH connection



Pairing this system with a BLUETOOTH device

Pairing is an operation in which BLUETOOTH devices register each other beforehand. Once the pairing operation has been performed, it does not need to be performed again for those devices.

If your device is an NFC-compatible smartphone, the manual pairing procedure is not necessary. (See "One Touch BLUETOOTH Connection by NFC" (page 17).)

1 Place the BLUETOOTH device within 1 meter (3 feet) from the system.

2 Select the BLUETOOTH function.

- 1 Press  to turn on the system.
- 2 Press **FUNCTION – PAIRING** repeatedly until the  (BLUETOOTH) indicator on the unit flashes slowly.

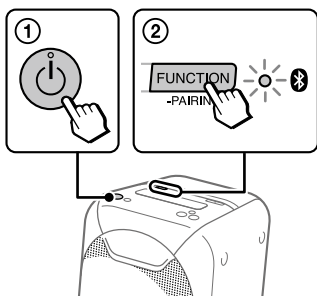

Hint

When there is no pairing information on the system (for example, when you use the BLUETOOTH function for the first time after purchase), the  (BLUETOOTH) indicator flashes quickly and the system enters the pairing mode automatically. In this case, proceed to step 4.

3 Hold down FUNCTION – PAIRING for more than 3 seconds.

Voice guidance ("Bluetooth pairing") will be output and the  (BLUETOOTH) indicator will flash quickly.

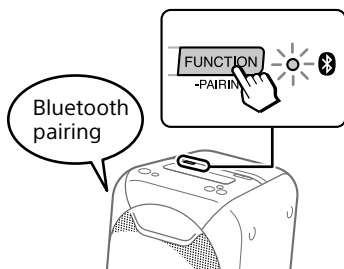

4 Turn on the BLUETOOTH function on the BLUETOOTH device.

For details, refer to the operating instructions of your BLUETOOTH device.

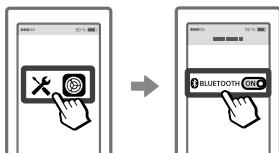

5 Select "GTK-XB60" or "GTK-XB90" on the display of the BLUETOOTH device.



Note

If passkey is required on the BLUETOOTH device, enter "0000." "Passkey" may be called "Passcode," "PIN code," "PIN number," or "Password."

6 Make sure that a BLUETOOTH connection has been established.

Once a BLUETOOTH connection is established, the system will emit a notification sound, and the  (BLUETOOTH) indicator on the unit will stop flashing and remain lit up.

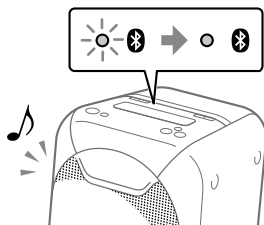

Depending on the BLUETOOTH device, connection may start automatically after pairing is completed.

Notes

- You can pair up to 8 BLUETOOTH devices. If the 9th BLUETOOTH device is paired, the oldest paired device will be deleted.
- If you want to pair with another BLUETOOTH device, repeat steps 1 to 6.
- If the last connected BLUETOOTH device is nearby, a BLUETOOTH connection will be established automatically and the BLUETOOTH indicator will light up.

To cancel the pairing operation

Press FUNCTION – PAIRING.

To terminate the BLUETOOTH connection

Turn off the BLUETOOTH function on the connected device.

Note

Depending on the BLUETOOTH device, the BLUETOOTH connection may be terminated automatically when you stop playback.

Erasing all the pairing registration information

To erase all of the pairing registration information, the system needs to be restored to the factory default settings. See “Restoring the system to the factory default settings” (page 38).

Note

Once all the pairing information on the system has been erased, iPhone/iPod touch may not be able to connect to the system. In this case, delete the pairing information for the system from iPhone/iPod touch, and then perform the pairing procedure again.

One Touch BLUETOOTH Connection by NFC

NFC (Near Field Communication) is a technology enabling short-range wireless communication between various devices, such as smartphones and IC tags.

When you touch the system with an NFC-compatible smartphone, the system automatically:

- turns on in the BLUETOOTH function.
- completes the pairing and BLUETOOTH connection.

Compatible smartphones

Smartphones with a built-in NFC function (OS: Android™ 2.3.3 or later, excluding Android 3.x)

Note

Depending on your NFC-compatible smartphone, you may need to perform the following steps on your NFC-compatible smartphone in advance.

- Turn on the NFC function. For details, refer to the operating instructions of the NFC-compatible smartphone.
- If your NFC-compatible smartphone has an OS version that is older than Android 4.1.x, download and start the "NFC Easy Connect" application. "NFC Easy Connect" is a free application for Android smartphones that can be obtained from Google Play™. (The application may not be available in some countries/regions.)

1 Turn on the NFC function of a BLUETOOTH device, such as a smartphone or tablet.



2 Touch the BLUETOOTH device to the N-Mark on the unit until the BLUETOOTH device responds to the system.

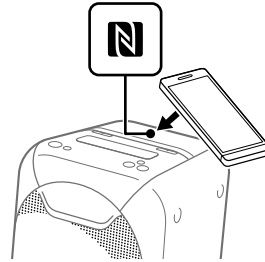

Complete the connection by following the instructions displayed on the BLUETOOTH device.

When the BLUETOOTH connection is established, the  (BLUETOOTH) indicator on the unit stops flashing and remains lit.

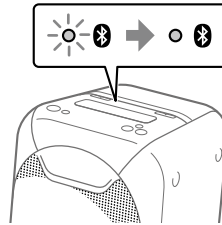

Hint

If pairing and the BLUETOOTH connection fail, perform the following.

- Remove the case from the smartphone if using a commercially available smartphone case.
- Touch the smartphone to the N-Mark on the unit again.
- Relaunch the "NFC Easy Connect" application.
- Unlock the screen of the BLUETOOTH device.

To terminate the BLUETOOTH connection

Touch the BLUETOOTH device to the N-Mark on the unit again.

Erasing all the pairing registration information

To erase all of the pairing registration information, the system needs to be restored to the factory default settings. See "Restoring the system to the factory default settings" (page 38).

Note

Once all the pairing information on the system has been erased, iPhone/iPod touch may not be able to connect to the system. In this case, delete the pairing information for the system from iPhone/iPod touch, and then perform the pairing procedure again.

Listening to music on a BLUETOOTH device

You can enjoy listening to music on a connected BLUETOOTH device.

Check the following before playing music:

- The BLUETOOTH function of the BLUETOOTH device is turned on.
- Pairing has been completed (page 15).

1 Press FUNCTION – PAIRING repeatedly until the (BLUETOOTH) indicator on the unit lights up.

The last connected BLUETOOTH device will be connected automatically.

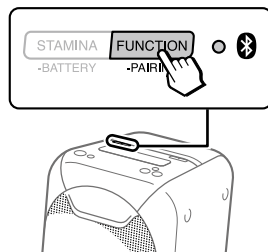

Note

If the  (BLUETOOTH) indicator flashes, the BLUETOOTH connection hasn't been established. In this case, complete the pairing procedure and establish a BLUETOOTH connection.

2 Start playback of an audio source on the BLUETOOTH device.

For details, refer to the operating instructions of your BLUETOOTH device.

You can also use **▶||/↶** on the system to play back/pause the music.



3 Adjust the volume.

Adjust the volume of the BLUETOOTH device first. If the volume level is still too low, adjust the volume level on the system using the volume +/- buttons.

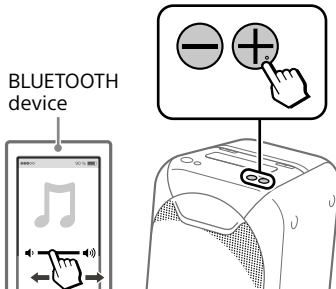

Switching between BLUETOOTH devices connected to the system at the same time (Multi-device Connection)

Up to 3 BLUETOOTH devices can be connected to the system at the same time.

While playing back an audio source from one of the connected devices, you can switch the BLUETOOTH input device by operating another connected device to start playback.

Notes

- You cannot use this function when using the hands-free call function, speaker add function, or Wireless Party Chain function.
- Depending on the BLUETOOTH devices, you may not be able to make 3 BLUETOOTH connections at the same time.

About the BLUETOOTH wireless technology

BLUETOOTH wireless technology is a short-range wireless technology that enables wireless data communication between digital devices. BLUETOOTH wireless technology operates within a range of about 10 meters (33 feet).

Supported BLUETOOTH version, profiles and codecs

For details, see “BLUETOOTH section” (page 40).

(BLUETOOTH) indicator

The  (BLUETOOTH) indicator on the unit lights up or flashes in blue to show the BLUETOOTH status.

System status	Indicator status
BLUETOOTH standby	Flashing slowly
BLUETOOTH pairing	Flashing quickly
BLUETOOTH connection is established	Lit up

Playing back with high quality sound codec (AAC/LDAC™)

This system can receive data in the AAC or LDAC codec format from a BLUETOOTH device. It provides a playback with higher sound quality.

You can select an audio codec option from the following two settings by using “Sony | Music Center” (page 22). The default setting of this system is “AUTO.”

- AUTO: The system detects the codec used on the source device and automatically selects the optimal codec from “SBC,” “AAC*” or “LDAC*.”
- SBC: “SBC” is always applied regardless of the codec used on the source device.

* Available only when the codec is supported by your BLUETOOTH device.

To apply the changes of the setting, you need to terminate the BLUETOOTH connection (page 16), and then perform the BLUETOOTH connection again.

Note

You can enjoy higher sound quality when the source device is compatible with AAC/LDAC and this function is set to “AUTO.” However, the sound may be interrupted depending on the conditions of the BLUETOOTH communication. If this happens, set the function to “SBC.”

LDAC is an audio coding technology developed by Sony, that enables the transmission of High-Resolution (Hi-Res) Audio content, even over a BLUETOOTH connection. Unlike other BLUETOOTH compatible coding technologies, such as SBC, it operates without any down-conversion of the Hi-Res Audio content¹⁾. It also allows approximately three times more data²⁾ than the other technologies, for transmitting over a BLUETOOTH wireless network with unprecedented sound quality using efficient coding and optimized data bundling.

¹⁾ Excluding DSD format contents.

²⁾ In comparison with SBC (Sub Band Codec), when the bit rate of 990 kbps (96/48 kHz) or 909 kbps (88.2/44.1 kHz) is selected.

Setting the BLUETOOTH standby mode

The BLUETOOTH standby mode enables the system to turn on automatically when you establish the BLUETOOTH connection with a BLUETOOTH device. This setting is turned off by default.

This setting can only be configured by using "Sony | Music Center." For details on "Sony | Music Center," see "Using "Sony | Music Center" and "Fiestable" via BLUETOOTH connection" (page 22).

Note

The BLUETOOTH standby mode can only be set to on while the AC power cord is connected.

Hint

Disable the BLUETOOTH standby mode to reduce the power consumption in standby mode (eco mode).

Turning on or off the BLUETOOTH signal

You can connect to the system from a paired BLUETOOTH device in all functions when the system's BLUETOOTH signal is set to on. This setting is turned on by default.

Hold down STAMINA – BATTERY and W.PARTY CHAIN – LIGHT for more than 5 seconds to turn off the BLUETOOTH signal.

AUDIO IN indicator will flash once.

Notes

- You cannot perform the following operations when you turn off the BLUETOOTH signal:
 - Pairing and/or connecting with BLUETOOTH device
 - Using "Sony | Music Center" via BLUETOOTH connection
- To turn on the BLUETOOTH signal, repeat the procedure shown above. When the BLUETOOTH signal turns on, the AUDIO IN indicator flashes 3 times.

Using “Sony | Music Center” and “Fiestable” via BLUETOOTH connection

About App



Sony | Music Center

Fiestable

You can control the system more flexibly and enjoy it in new ways using the free Apps “Sony | Music Center” and “Fiestable” on your smartphone/iPhone. “Sony | Music Center” and “Fiestable” are available in both Google Play and the App Store.

1 Search for “Sony | Music Center” and download the App to your smartphone/iPhone.

You can also download the App by scanning the two-dimensional code below.



2 Establish a BLUETOOTH connection between the system and your smartphone/iPhone.

For details on BLUETOOTH connection, see “Pairing this system with a BLUETOOTH device” (page 15) or “One Touch BLUETOOTH Connection by NFC” (page 17).

3 Launch “Sony | Music Center” and download “Fiestable.”



Hint

You can also download “Fiestable” from the App Store or Google Play.

What you can do with “Sony | Music Center”:

- Play back music on a USB device and set play modes
- Balance the sound using preset EQs or custom EQs
- Change the sound effect using DJ EFFECT
- Control multiple systems when using the Wireless Party Chain or speaker add function
- Check the battery level
- Configure the various settings for the system

What you can do with “Fiestable”:

- DJ Control
- Illumination
- Motion Control

► Refer to “Sony | Music Center” Help for more details.

<http://info.vssupport.sony.net/help/>



Notes

- If the “Sony | Music Center” application does not work properly, terminate the BLUETOOTH connection (page 16), then perform the BLUETOOTH connection again so that the BLUETOOTH connection functions normally.
- What you can control with “Sony | Music Center” varies depending on the connected device.
- The specification and design of the application may change without notice.

Sound Adjustment

Adjusting the sound

To	Do this
Adjust the volume	Press the volume +/- buttons.
Generate a more dynamic sound	Press EXTRA BASS. The EXTRA BASS indicator lights up in red while the EXTRA BASS function is turned on.

Enjoying wired playback using multiple systems (Wired Party Chain function)

You can connect multiple audio systems in a chain to create a more interesting party environment and to produce higher sound output. An activated system in the chain will be the "Party Host" and share the music. Other systems will become "Party Guests" and play the same music as that being played by the "Party Host."

Setting up the Wired Party Chain

Set up a Wired Party Chain by connecting all the systems using audio cords (not supplied). Before connecting the cords, be sure to turn off the system and disconnect the AC power cord.

A If all the systems are equipped with the Wired Party Chain function

Example: When connecting using this system as the first system

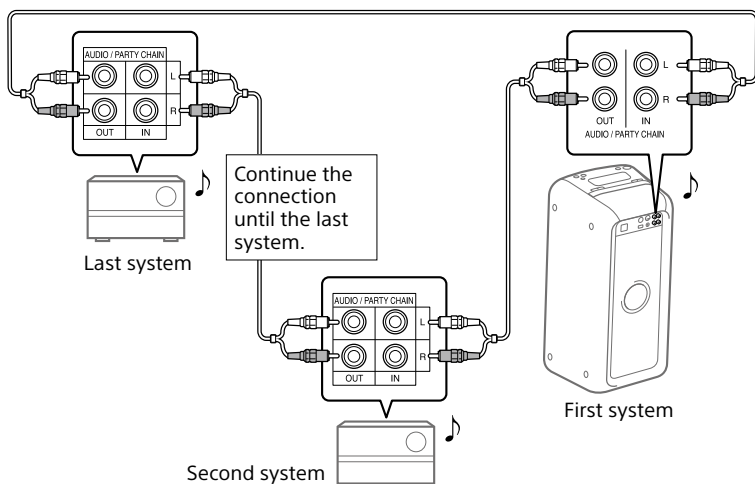

- Any system can become a Party Host. You can change the Party Host to another system in the chain. For details, see "To select a new Party Host" (page 26).
- Make sure that the  (BLUETOOTH) function or USB function is selected. When the Audio In function is selected, this feature cannot be used.

Note

You do not need to connect the last system to the first system. In this case, only the first system can become a Party Host.

B If one of the systems is not equipped with the Wired Party Chain function

Example: When connecting using this system as the first system

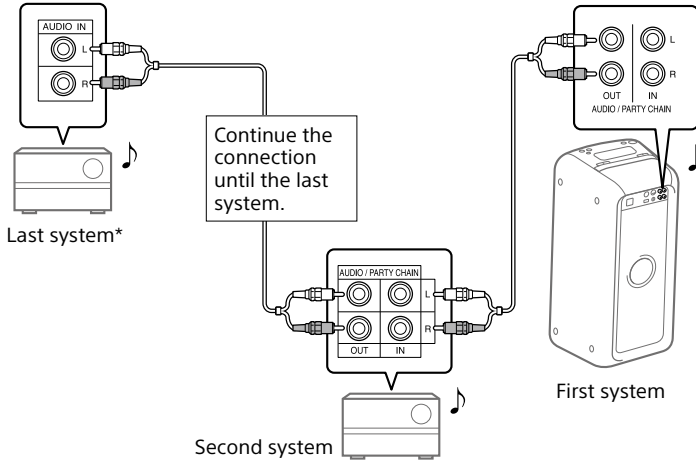

* Connect the system that is not equipped with the Wired Party Chain function as the last system. Be sure to select the Audio In function on the last system. In this configuration, the sound from the last system may lag behind others.

- The last system is not connected to the first system.
- You must select the first system as Party Host so that all systems are playing the same music when Wired Party Chain function is activated.

Enjoying the Wired Party Chain

- 1 Turn on all the systems.
- 2 Activate the Wired Party Chain function on the system to be used as the Party Host.

Example: When using this system as the Party Host

- ① Press **FUNCTION – PAIRING** repeatedly to select the function you want.
When you connect using **A** (page 24), do not select the Audio In function. If you select this function, sound cannot be output.
- ② Start playback and then press **PARTY CHAIN** on the rear of the unit.
The PARTY CHAIN indicator lights up. The Party Host starts the Wired Party Chain, and other systems become Party Guests automatically. All systems play the same music as that being played by the Party Host.

- 3 Adjust the volume on each system.

Notes

- Depending on the total unit of systems you have connected, Party Guests may take some time to start playing the music.
- Changing the volume level and sound effect on the Party Host will not affect the output on the Party Guests.
- For detailed operation on other systems, refer to the operating instructions of the systems.

To select a new Party Host

Only when you connect using **A** (page 24), you can select a new Party Host. Repeat step 2 of “Enjoying the Wired Party Chain” on the system to be used as a new Party Host. The current Party Host becomes Party Guest automatically. All systems play the same music as that being played by the new Party Host.

Notes

- You can select another system as the new Party Host only after the Wired Party Chain function of all the systems in the chain has been activated.
- If the selected system does not become a new Party Host after a few seconds, repeat step 2 of “Enjoying the Wired Party Chain.”

To deactivate the Wired Party Chain

Press **PARTY CHAIN** on the Party Host.

Note

If the Wired Party Chain function is not deactivated after a few seconds, press **PARTY CHAIN** on the Party Host again.

Party Chain indicator

The PARTY CHAIN indicator on the unit lights up or flashes to show the system status.

System status	Indicator status
Party Host	Lit up
Party Guest	Flashing

Enjoying wireless playback using multiple systems (Wireless Party Chain function)

You can connect multiple audio systems in a chain via BLUETOOTH connection if all the systems are equipped with the Wireless Party Chain function. This function allows you to create a more exciting party environment and to produce higher sound output without a cable connection.

The first system in the chain to be activated becomes the "Party Host" and shares the music. Other systems become "Party Guests" and play the same music as that being played by the "Party Host."

Setting up and enjoying the Wireless Party Chain

Example: setting the GTK-XB60 or GTK-XB90 as the first system (Party Host)

- 1 Turn on all the systems.**
- 2 Set the first system as the Party Host.**
 - Press FUNCTION – PAIRING repeatedly until the  (BLUETOOTH) indicator lights up.
 - Connect the BLUETOOTH device to the system via BLUETOOTH connection.
 - Press W.PARTY CHAIN – LIGHT on the unit. The W.PARTY CHAIN – LIGHT indicator will start flashing and the system will enter the Wireless Party Chain mode.

3 Set the second system as a Party Guest.

- Press FUNCTION – PAIRING on the second system repeatedly until the  (BLUETOOTH) indicator lights up.
- Press W.PARTY CHAIN – LIGHT on the second system. The second system will be set as a Party Guest.
- Make sure that the W.PARTY CHAIN – LIGHT indicator on the Party Guest starts flashing and the W.PARTY CHAIN – LIGHT indicator on the Party Host stops flashing and remains lit up.

Note

The Wireless Party Chain function is canceled in the following situations.

- There is no operation within 1 minute after the Party Host is set in step 2.
- W.PARTY CHAIN – LIGHT is pressed on the Party Host before step 3 is completed.

4 Set the third or more systems as Party Guests.

Repeat step 3.

Note

Connect the third or later systems within 30 seconds of connecting the previous system. After 30 seconds or more have elapsed, the system cannot be connected.

5 Start playing back an audio source on the Party Host.

6 Adjust the volume on each system.

To deactivate the Wireless Party Chain

Press FUNCTION – PAIRING or turn the power off on the Party Host.

To make a Party Guest leave the Wireless Party Chain

Press FUNCTION – PAIRING or turn the power off on the Party Guest you want to leave. In this case, the rest of the Wireless Party Chain will continue to be activated.

Hint

To add new Party Guests after Wireless Party Chain has already been established, repeat the procedure from ③ in step 2.

Wireless Party Chain indicator

The W.PARTY CHAIN – LIGHT indicator on the unit lights up or flashes to show the system status.

System status	Indicator status
Party Host	Lit up
Party Guest	Flashing

Listening to music wirelessly with two systems (Speaker add function)

To use this function, two GTK-XB60 or two GTK-XB90 systems are required.* By connecting two systems via BLUETOOTH wireless technology, you can enjoy music in a more powerful way. You can also select an audio output between double mode (in which the two systems play the same sound) and stereo mode (stereo sound).

In the following steps, the two systems are described as “system [A]” (or master system) and “system [B].”

* Only the same model systems can be used in speaker add function. For example, you cannot use this function with a combination of GTK-XB60 and GTK-XB90 models.

Activating the speaker add function

- 1 Bring two GTK-XB60 or GTK-XB90 systems within 1 meter (3 feet) of each other.
- 2 Press FUNCTION – PAIRING on system [A] repeatedly until the  (BLUETOOTH) indicator on the unit lights up.
- 3 Press ADD on system [A]. The ADD L/R indicators will flash and the system will enter the speaker add mode.

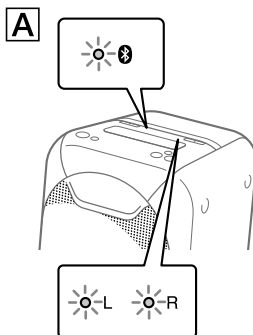

- 4 Press FUNCTION – PAIRING on system [B] repeatedly until the  (BLUETOOTH) indicator on the unit lights up.

5 Press **ADD** on system **B**. The **ADD L/R indicators on the unit will flash.**

Then the L/R indicators on both systems change their status from flashing to lit while the **BLUETOOTH** indicator on system **B** is turned off.

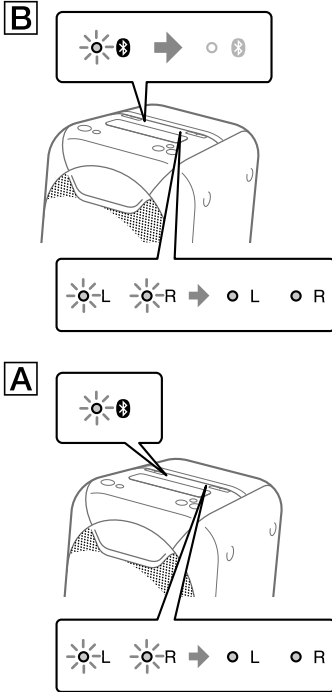

Hint

When the connection by the speaker add function is established very quickly, the L/R indicators on system **B** may light up directly without flashing.

6 Hold down **ADD** on system **A** repeatedly to select the **output mode.**

The ADD L/R indicators on both systems show the current output mode.

Each time you hold down ADD, the output mode changes as follows.

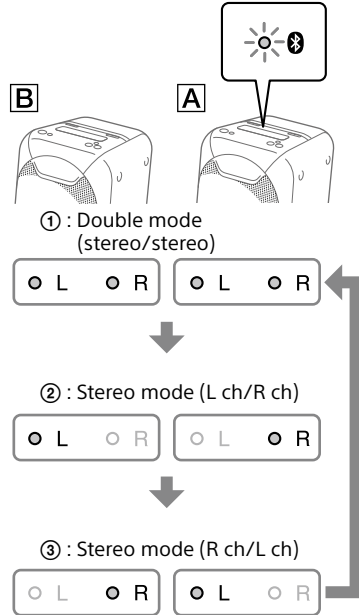

Hint

To change the output mode, operate system **A** (master system), on which you have activated the speaker add mode.

Playing music with two systems

1 Activate the pairing mode on system [A], and then perform the BLUETOOTH connection with a BLUETOOTH device.

For details on the pairing, see "Pairing this system with a BLUETOOTH device" (page 15) or "One Touch BLUETOOTH Connection by NFC" (page 17). Make sure to pair the BLUETOOTH device with system [A] (master system).

2 Start playback on the BLUETOOTH device, and adjust the volume.

For details, see "Listening to music on a BLUETOOTH device" (page 18).

Volume adjustments made on either one of the systems are also reflected on the other system.

Notes

- If any other BLUETOOTH device(s), such as a BLUETOOTH mouse or BLUETOOTH keyboard, is connected to the BLUETOOTH device that is connecting with the system, there may be distorted sound or noise in the system output. In this case, terminate the BLUETOOTH connection between the BLUETOOTH device and other BLUETOOTH device(s).
- If you reset one of the two systems while using the speaker add function, make sure to turn off the other system. If you do not turn off the other system before restarting the speaker add function, there may be problems in making a BLUETOOTH connection and outputting sound.

To deactivate the speaker add function

Press ADD. The ADD L/R indicators will be turned off.

Hint

Unless you deactivate the function, the system will try to establish the last made connection next time you turn on the system.

Enjoying music with the Speaker Lights

The Speaker Lights are turned on by default.

You can also select various light modes such as the following by using "Sony | Music Center" (page 22).

- RAVE: a light mode suitable for dance music with a lot of flashing
- CHILL: a light mode suitable for relaxing music
- RANDOM FLASH OFF: a light mode without flash suitable for all music, including dance music
- HOT: a light mode of warm color
- COOL: a light mode of cool color
- STROBE: a light mode with an electronic flash of white color

To turn off the Speaker Lights

Hold down W.PARTY CHAIN – LIGHT. To turn on the Speaker Lights, hold down W.PARTY CHAIN – LIGHT again.

Note

If the illumination brightness is glaring, switch on the room lights or turn off the illumination.

Enjoying hands-free calls

You can enjoy hands-free calls with a BLUETOOTH mobile phone that supports HFP (Hands-free Profile) or HSP (Headset Profile).

To use this function, make sure that a BLUETOOTH connection has been established.

Note

Depending on the model of your smartphone, the operation system or applications installed, some functions of hands-free calling may not be used correctly.

Receiving a call

1 Press ►||/↶ when a call is incoming.

When an incoming call arrives, playback pauses and the system emits a ring tone.

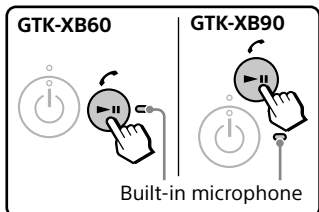

Note

If you hold down ►||/↶ when a call is incoming, the call will be rejected.

2 Talk into the system's built-in microphone.

3 Press ►||/↶ to end the call.

Making a call

1 Make a call by operating the connected BLUETOOTH mobile phone.

When you make a call, playback will pause and the system will emit a dial tone.

2 Talk into the system's built-in microphone when the other party answers the call.

3 Press ►||/↶ to end the call.

Note

If you hold down ►||/↶ while talking, the phone call output will be switched from the system to the speaker on your mobile phone.

Hints

- If your BLUETOOTH mobile phone supports both HFP and HSP, set it to HFP.
- If you were listening to music before the call, playback will resume when the call ends.
- Operations may vary depending on the BLUETOOTH mobile phone. Refer to the operating instructions for your mobile phone.

Using an optional equipment

- 1 Connect an optional equipment (i.e. WALKMAN®, smartphone, TV, DVD player, IC recorder, etc.) to the AUDIO/PARTY CHAIN IN L/R jacks on the unit using an audio cord (not supplied).**
- 2 Press FUNCTION – PAIRING repeatedly until the AUDIO IN indicator on the unit lights up.**
- 3 Start playback on the connected equipment.**
- 4 Adjust the volume.**
Adjust the volume of the connected equipment first. If the volume level is still too low, adjust the volume level on the system using the volume +/- buttons.

Note

The system may enter standby mode automatically if the volume level of the connected equipment is too low. In this case, increase the volume level of the equipment. To turn off the automatic standby function, see “Setting the automatic standby function” (page 33).

Using an optional microphone

You can output your voice from the system by connecting a dynamic microphone with a normal plug (not supplied).

- 1 Turn the MIC LEVEL knob to MIN to reduce the microphone volume level.**

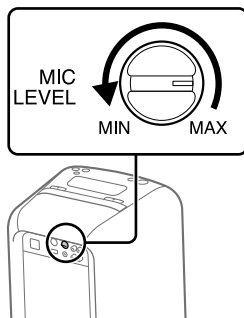

- 2 Connect an optional microphone to the MIC jack on the unit.**
- 3 Adjust the volume using the MIC LEVEL knob.**
- 4 Speak or sing into the connected microphone.**

Note

When using the Wireless Party Chain or speaker add function, sound from the microphone is only output from the system to which the microphone is connected.

Setting the automatic standby function

By default, this system is set to turn off automatically in about 15 minutes when there is no operation or audio signal output.

To turn off the function, hold down  for more than 3 seconds while the system is turned on.

The  indicator will flash once.

To turn on the function, repeat the procedure. The  indicator will flash for 3 times.

You can also configure this setting and make sure whether this function is turned on or off by using “Sony | Music Center.” For details on “Sony | Music Center,” see “Using “Sony | Music Center” and “Fiestable” via BLUETOOTH connection” (page 22).

Notes

- The system may enter standby mode automatically if the volume level of the connected equipment is too low. In this case, increase the volume level of the equipment.
- The system doesn't enter standby mode when the MIC jack is in use.

Saving the battery power

You can save power and use the system for longer periods of time by turning on the STAMINA mode when using the system with the built-in battery (rechargeable).

Press STAMINA – BATTERY to turn on the STAMINA mode.

The STAMINA – BATTERY indicator will light up.

To deactivate the function, press STAMINA – BATTERY again.

Hint

For details on the battery life, see “Usage life of the lithium-ion battery” (page 41).

Information about compatible devices

About supported USB devices

- This system supports USB Mass Storage Class only.
- This system supports FAT formatted USB devices only (except exFAT).
- Some USB devices may not work with this system.

About BLUETOOTH communication for iPhone and iPod models

Made for

- iPhone 7
- iPhone 7 Plus
- iPhone SE
- iPhone 6s
- iPhone 6s Plus
- iPhone 6
- iPhone 6 Plus
- iPhone 5s
- iPhone 5c
- iPhone 5
- iPhone 4s
- iPod touch (6th generation)
- iPod touch (5th generation)

Websites for compatible devices

Check the websites below for the latest information about compatible BLUETOOTH devices.

For customers in the USA:

<http://esupport.sony.com/>

For customers in Canada:

<http://esupport.sony.com/CA>

For customers in Europe:

<http://www.sony.eu/support>

For customers in Latin America:

<http://esupport.sony.com/LA>

For customers in other countries/ regions:

<http://www.sony-asia.com/support>

Troubleshooting

If a problem occurs while operating the system, follow the steps described below before consulting your nearest Sony dealer. If an error message appears, be sure to make a note of the contents for reference.

1 Check to see if the problem is listed in this “Troubleshooting” section.

2 Check the following customer support websites.

For customers in the USA:

<http://esupport.sony.com/>

For customers in Canada:

<http://esupport.sony.com/CA>

For customers in Europe:

<http://www.sony.eu/support>

For customers in Latin America:

<http://esupport.sony.com/LA>

For customers in other countries/ regions:

<http://www.sony-asia.com/support>

You will find the latest support information and a FAQ at these websites.

If the problem persists, consult your nearest Sony dealer.

Note that if the service personnel changes some parts during repair, these parts may be retained.

General

The system does not turn on.

- Charge the built-in battery.
- Check that the AC power cord is connected securely.

The system has entered standby mode.

- This is not a malfunction. The system enters standby mode automatically in about 15 minutes when there is no operation or audio signal output (page 33).

There is no sound.

- Adjust the volume.
- Check the connection of the optional equipment, if any.
- Turn on the connected equipment.
- Disconnect the AC power cord, then reconnect the AC power cord and turn on the system.

There is severe hum or noise.

- Move the system away from sources of noise.
- Connect the system to a different wall outlet.
- Install a noise filter (commercially available) to the AC power cord.
- Turn off surrounding electrical equipment.

There is acoustic feedback.

- Reduce the volume.

USB device

The connected USB device cannot be charged.

- Make sure the USB device is connected securely.
- If the remaining battery level of the system is less than 10%, the connected USB device cannot be charged.

The USB device does not work properly.

- If you connect an unsupported USB device, the following problems may occur. See "Information about compatible devices" (page 34).
 - The USB device is not recognized.
 - Playback is not possible.
 - The sound skips.
 - There is noise.
 - A distorted sound is output.

There is no sound.

- The USB device is not connected correctly. Turn off the system, then reconnect the USB device.

There is noise, skipping, or distorted sound.

- You are using an unsupported USB device. See "Information about compatible devices" (page 34).
- Turn off the system and reconnect the USB device, then turn on the system.
- The music data itself contains noise, or the sound is distorted. Noise may have been entered during music creation process using the computer. Create the music data again.
- The bit rate used when encoding an audio file was low. Send an audio file with higher bit rates to the USB device.

The USB device is not recognized.

- Turn off the system and reconnect the USB device, then turn on the system.
- You are using an unsupported USB device. See "Information about compatible devices" (page 34).
- The USB device is not working properly. Refer to the operating instructions of the USB device on how to deal with this problem.

Playback does not start.

- Turn off the system and reconnect the USB device, then turn on the system.
- You are using an unsupported USB device. See "Information about compatible devices" (page 34).

Playback does not start from the first file.

- Set the play mode to normal play mode using "Sony | Music Center" (page 22).

Files cannot be played back.

- USB devices formatted with file systems other than FAT16 or FAT32 are unsupported.*
 - If you use a partitioned USB device, only files on the first partition can be played back.
 - Files that are encrypted or protected by passwords cannot be played back.
 - Files with DRM (Digital Rights Management) copyright protection cannot be played back by this system.
- * This system supports FAT16 and FAT32, but some USB storage devices may not support all of these FAT. For details, refer to the operating instructions of each USB storage device or contact the manufacturer.

BLUETOOTH device

Pairing cannot be performed.

- Move the BLUETOOTH device closer to the system.
- Pairing may not be possible if other BLUETOOTH devices are present around the system. In this case, turn off the other BLUETOOTH devices.
- Make sure to enter the correct passkey when selecting the system's name (this system) on the BLUETOOTH device.

The BLUETOOTH device cannot detect the system.

- Set the BLUETOOTH signal to on (page 21).

Connection is not possible.

- The BLUETOOTH device you attempted to connect does not support the A2DP profile, and cannot be connected with the system.
- Enable the BLUETOOTH function of the BLUETOOTH device.
- Establish a connection from the BLUETOOTH device.
- The pairing registration information has been erased. Perform the pairing operation again.
- Erase the pairing registration information of the BLUETOOTH device by restoring the system to factory default settings (page 38) and perform the pairing operation again (page 15).
- Once all the pairing information on the system has been erased, iPhone/iPod touch may not be able to connect to the system. In this case, delete pairing information of the system on iPhone/iPod touch, and then perform the pairing procedure again.

The sound skips or fluctuates, or the connection is lost.

- The system and the BLUETOOTH device are too far apart.
- If there are obstacles between the system and your BLUETOOTH device, remove or avoid the obstacles.
- If there is equipment that generates electromagnetic radiation, such as a wireless LAN, other BLUETOOTH device, or a microwave oven nearby, move them away.

The sound of your BLUETOOTH device cannot be heard on this system.

- Increase the volume on your BLUETOOTH device first, then adjust the volume using the volume +/- buttons.

There is severe hum, noise, or distorted sound.

- If there are obstacles between the system and your BLUETOOTH device, remove or avoid the obstacles.
- If there is equipment that generates electromagnetic radiation, such as a wireless LAN, other BLUETOOTH device, or a microwave oven nearby, move them away.
- Turn down the volume of the connected BLUETOOTH device.

Party Chain and speaker add function

Wired Party Chain function cannot be activated.

- Check the connections (page 24).
- Make sure the audio cords are connected correctly.
- Select the function other than the Audio In function (page 26).

Wired Party Chain function does not work properly.

- Turn off the system. Then, turn it back on again to activate the Wired Party Chain function.

Unable to connect a BLUETOOTH device with the system in the Wireless Party Chain function.

- After connecting all of the systems, perform the pairing procedure between the BLUETOOTH device and the system whose W.PARTY CHAIN – LIGHT indicator is lit up. Then perform the BLUETOOTH connection.

Unable to connect a BLUETOOTH device with the system in the speaker add function.

- After connecting two GTK-XB60 or two GTK-XB90 systems, perform the pairing procedure between the BLUETOOTH device and the system whose  (BLUETOOTH) indicator is flashing. Then perform the BLUETOOTH connection.

Resetting the system

If the system doesn't respond and cannot be operated despite the power being on, reset the system using the RESET button.

- 1 Press RESET on the rear of the unit with a pin or other pointed object.**

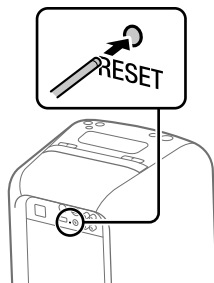

The system will turn off.

- 2 Press  to turn the system back on.**

Notes



- If the system doesn't turn back on, consult your Sony dealer.
- Pairing information is not deleted when you press RESET.

Restoring the system to the factory default settings

If the system still does not operate properly, restore it to the factory default settings.

1 Press  to turn on the system.

2 Hold down **FUNCTION – PAIRING** and the **volume – button** for more than **5 seconds**.

After the ,  (BLUETOOTH), **USB**, and **AUDIO IN** indicators on the unit flash 2 times, all user-configured settings, such as the pairing registration information, are restored to factory default settings.

Precautions

On safety

- Completely disconnect the AC power cord (mains lead) from the wall outlet (mains) if it is not going to be used for an extended period of time. When unplugging the unit, always grip the plug. Never pull the cord itself.
- Should any solid object or liquid get into the system, unplug the system, and have it checked by qualified personnel before operating it again.
- AC power cord must be changed only at the qualified service shop.

On placement

- Do not place the system in an inclined position or in locations that are extremely hot, cold, dusty, dirty, or humid or lacking adequate ventilation, or subject to vibration, direct sunlight or a bright light.
- Be careful when placing the system on surfaces that have been specially treated (for example, wax, oil, polish) as staining or discoloration of the surface may result.
- Make sure not to splash water on the unit. This unit is not waterproof.

On heat buildup

- Heat buildup on the system during operation is normal and is not a cause for alarm.
- Do not touch the cabinet if it has been used continuously at a high volume because the cabinet may have become hot.
- Do not obstruct the ventilation holes.

On the speaker system

The built-in speaker system is not magnetically shielded, and the picture on nearby TV sets may become magnetically distorted. In this situation, turn off the TV, wait 15 to 30 minutes, and turn it back on. If there is no improvement, move the system far away from the TV.

Cleaning the cabinet

Clean this system with a soft cloth slightly moistened with a mild detergent solution. Do not use any type of abrasive pad, scouring powder, or solvent, such as thinner, benzene, or alcohol.

On BLUETOOTH Communication

- BLUETOOTH devices should be used within approximately 10 meters (33 feet) (unobstructed distance) of each other. The effective communication range may become shorter under the following conditions.
 - When a person, metal object, wall or other obstruction is between the devices with a BLUETOOTH connection
 - Locations where a wireless LAN is installed
 - Around microwave ovens that are in use
 - Locations where other electromagnetic waves are generated
- BLUETOOTH devices and wireless LAN (IEEE 802.11b/g) equipment use the same frequency band (2.4 GHz). When using your BLUETOOTH device near a device with wireless LAN capability, electromagnetic interference may occur. This could result in lower data transfer rates, noise, or inability to connect. If this happens, try the following remedies:
 - Use this system at least 10 meters (33 feet) away from the wireless LAN equipment.
 - Turn off the power to the wireless LAN equipment when using your BLUETOOTH device within 10 meters (33 feet).
 - Use this system and BLUETOOTH device as closer to each other as possible.
- The radio waves broadcast by this system may interfere with the operation of some medical devices. Since this interference may result in malfunction, always turn off the power on this system and BLUETOOTH device in the following locations:
 - In hospitals, on trains, in airplanes, at gas stations, and any place where flammable gases may be present
 - Near automatic doors or fire alarms
- This system supports security functions that comply with BLUETOOTH specifications to ensure secure connections during communication using BLUETOOTH technology. However, this security may be insufficient depending on the setting contents and other factors, so always be careful when performing communication using BLUETOOTH technology.
- Sony cannot be held liable in any way for damages or other loss resulting from information leaks during communication using BLUETOOTH technology.
- BLUETOOTH communication is not necessarily guaranteed with all BLUETOOTH devices that have the same profile as this system.
- BLUETOOTH devices connected with this system must comply with the BLUETOOTH specification prescribed by the Bluetooth SIG, Inc., and must be certified to comply. However, even when a device complies with the BLUETOOTH specification, there may be cases where the characteristics or specifications of the BLUETOOTH device make it impossible to connect, or may result in different control methods, display or operation.
- Noise may occur or the audio may cut off depending on the BLUETOOTH device connected with this system, the communications environment, or surrounding conditions.

Specifications

Speaker section

GTK-XB60:

Tweeter: 50 mm (2 in) × 2, cone type

Woofer: 130 mm (5 1/8 in) × 2, cone type

GTK-XB90:

Tweeter: 60 mm (2 3/8 in) × 3, cone type

Woofer: 180 mm (7 1/8 in) × 2, cone type

Inputs

AUDIO/PARTY CHAIN IN L/R:

Voltage 2 V, impedance 10 kilohms

MIC:

Sensitivity 1 mV, impedance

10 kilohms

Outputs

AUDIO/PARTY CHAIN OUT L/R:

Voltage 2 V, impedance 600 ohms

USB section and supported audio formats

⚡ (USB) port:

Type A, maximum current 2.1 A

Supported bit rate:

MP3 (MPEG1 Audio Layer-3):

32 kbps – 320 kbps, VBR

WMA: 32 kbps – 192 kbps, VBR

Sampling frequencies:

MP3 (MPEG1 Audio Layer-3):

32/44.1/48 kHz

WMA: 44.1 kHz

BLUETOOTH section

Communication system:

BLUETOOTH Standard version 4.2

Output:

BLUETOOTH Standard Power Class 2

Maximum output power:

GTK-XB60: < 2.8 dBm

GTK-XB90: < 2.0 dBm

Maximum communication range:

Line of sight approx. 10 m (33 feet)¹⁾

Frequency band:

2.4 GHz band (2.4000 GHz –

2.4835 GHz)

Modulation method:

FHSS (Freq Hopping Spread Spectrum)

Compatible BLUETOOTH profiles²⁾:

A2DP (Advanced Audio Distribution Profile)

AVRCP (Audio Video Remote Control Profile)

HFP (Hands-free Profile)

HSP (Headset Profile)

SPP (Serial Port Profile)

Supported codecs:

SBC (Sub Band Codec)

AAC (Advanced Audio Coding)

LDAC

¹⁾ The actual range will vary depending on factors such as obstacles between devices, magnetic fields around a microwave oven, static electricity, reception sensitivity, antenna's performance, operating system, software application, etc.

²⁾ BLUETOOTH standard profiles indicate the purpose of BLUETOOTH communication between devices.

NFC section

Operating frequency:

13.56 MHz

Lithium-ion battery section

GTK-XB60:

- Normal voltage: 14.4 V \approx
- Normal capacity: 2500 mAh, 36 Wh
- Maximum charging current: 1 A
- Maximum charging voltage: 16.7 Vdc

GTK-XB90:

- Normal voltage: 21.6 V \approx
- Normal capacity: 2500 mAh, 54 Wh
- Maximum charging current: 1 A
- Maximum charging voltage: 24.9 Vdc

Usage life of the lithium-ion battery

When the Speaker Lights are turned off:

GTK-XB60:

- 3.5 hours (at the maximum volume level)
- 5 hours (at the maximum volume level with the STAMINA mode turned on)
- 14 hours (at volume level 17)

GTK-XB90:

- 3.5 hours (at the maximum volume level)
- 5 hours (at the maximum volume level with the STAMINA mode turned on)
- 16 hours (at volume level 16)

When the Speaker Lights are turned on:

GTK-XB60:

- 3 hours (at the maximum volume level)

GTK-XB90:

- 3 hours (at the maximum volume level)

The times given above:

- were measured using a predetermined music source.
- may vary depending on the playback content.
- will be shortened if you charge and discharge the battery repeatedly.

General

Power requirements:

- North American model: AC 120 V, 60 Hz
- Other models: AC 120 V — 240 V, 50/60 Hz

Power consumption:

- GTK-XB60: 55 W
- GTK-XB90: 60 W

Standby power consumption:

- When BLUETOOTH standby mode is set to off: 0.5 W (eco mode)
- When BLUETOOTH standby mode is set to on: 1.5 W (all wireless network ports on)

Dimensions (W/H/D) (Approx.):

- GTK-XB60:
264 mm × 552 mm × 272 mm
(10 ¹/₂ in × 21 ³/₄ in × 10 ³/₄ in)

- GTK-XB90:
336 mm × 670 mm × 335 mm
(13 ¹/₄ in × 26 ¹/₂ in × 13 ¹/₄ in)

Mass (Approx.):

- GTK-XB60: 8 kg (17 lb 11 oz)
- GTK-XB90: 14 kg (30 lb 14 oz)

Quantity of the system:

- 1 piece

Supplied accessories:

- AC power cord (1)

Design and specifications are subject to change without notice.

License and Trademark Notice

- MPEG Layer-3 audio coding technology and patents licensed from Fraunhofer IIS and Thomson.
- Windows Media is either a registered trademark or trademark of Microsoft Corporation in the United States and/or other countries.
- This product is protected by certain intellectual property rights of Microsoft Corporation. Use or distribution of such technology outside of this product is prohibited without a license from Microsoft or an authorized Microsoft subsidiary.
- The BLUETOOTH® word mark and logos are registered trademarks owned by Bluetooth SIG, Inc. and any use of such marks by Sony Corporation is under license. Other trademarks and trade names are those of their respective owners.
- The N-Mark is a trademark or registered trademark of NFC Forum, Inc. in the United States and in other countries.
- Google Play and Android are trademarks of Google Inc.
- LDAC™ and LDAC logo are trademarks of Sony Corporation.
- Apple, the Apple logo, iPhone, and iPod touch are trademarks of Apple Inc., registered in the U.S. and other countries. App Store is a service mark of Apple Inc.
- Use of the Made for Apple badge means that an accessory has been designed to connect specifically to the Apple product(s) identified in the badge, and has been certified by the developer to meet Apple performance standards. Apple is not responsible for the operation of this device or its compliance with safety and regulatory standards. Please note that the use of this accessory with iPod or iPhone may affect wireless performance.
- WALKMAN and WALKMAN logo are registered trademarks of Sony Corporation.
- All other trademarks and registered trademarks are of their respective holders. In this manual, ™ and ® marks are not specified.

<http://www.sony.net/>

