

Assembly instructions for the ottoman:

- Tools:** A screwdriver is shown as the required tool. A power drill is shown with a diagonal line through it, indicating it is not to be used.
- Warning:** A warning triangle with an exclamation mark is positioned to the right of the tool icons.
- Time:** A clock icon is shown, with the text "15'" below it, indicating an estimated assembly time of 15 minutes.
- Personnel:** An icon of a person is shown, with the number "2" below it, indicating that two people are required for assembly.

A

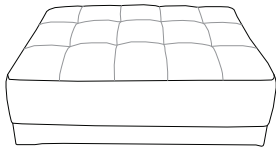

x 1

B

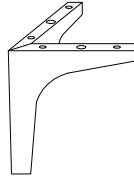

x 4

C

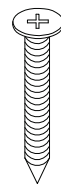

5
x
25

x 16

A

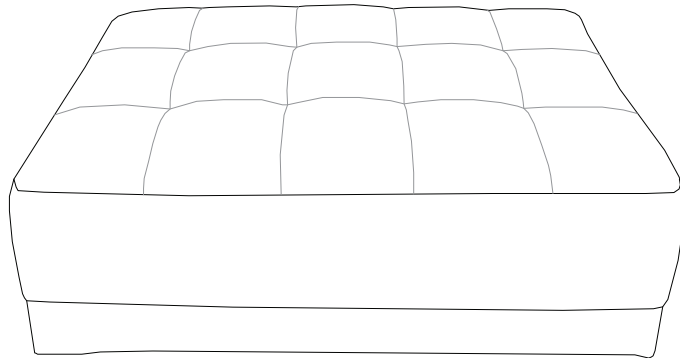

B x 4

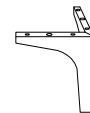

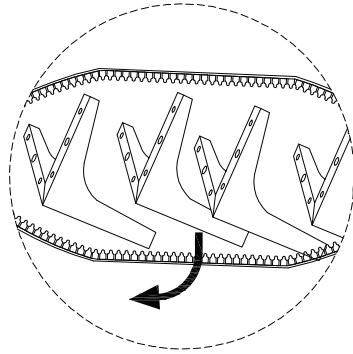
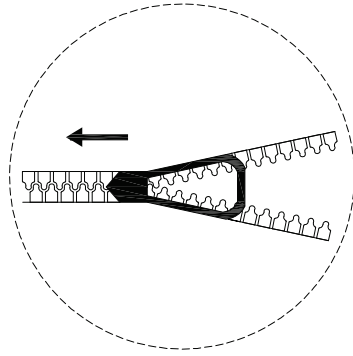
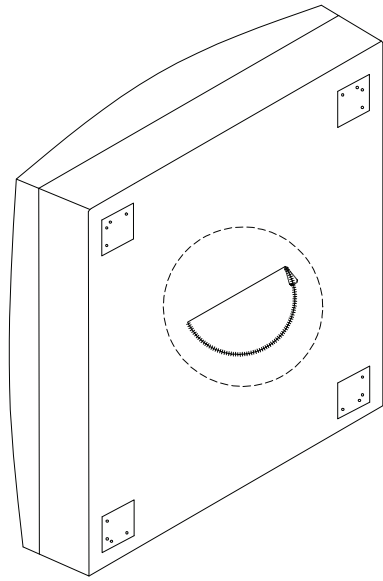

1

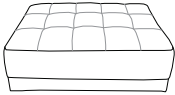
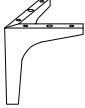
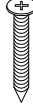
<p>A</p>  <p>x 1</p>	<p>B</p>  <p>x 4</p>	<p>C</p>  <p>5 x 25</p> <p>x 16</p>
--	--	---

