

New MAGNA1

Model C

Installation and operating instructions



English (GB) Installation and operating instructions

Original installation and operating instructions

These installation and operating instructions describe New MAGNA1 model C.

Sections 1-5 give the information necessary to be able to unpack, install and start up the product in a safe way.

Sections 6-11 give important information about the product, as well as information on service, fault finding and disposal of the product.

CONTENTS

	Page
1. General information	2
1.1 Hazard statements	2
1.2 Notes	3
1.3 Symbols on the product	3
2. Receiving the product	3
2.1 Inspecting the product	3
2.2 Scope of delivery	3
2.3 Lifting the product	4
3. Installing the product	5
3.1 Location	5
3.2 Tools	5
3.3 Insulating shells	5
3.4 Mechanical installation	6
3.5 Electrical connection	10
4. Starting up the product	15
4.1 Single-head pump	15
4.2 Twin-head pump	16
4.3 Pairing and unpairing twin-head pumps	16
5. Handling and storing the product	17
6. Product introduction	17
6.1 Product description	17
6.2 Intended use	17
6.3 Pumped liquids	17
6.4 Identification	18
6.5 Radio communication	18
6.6 Non-return valve	18
6.7 Closed valve operation	19
6.8 Accessories	19
7. Control functions	20
7.1 Proportional-pressure curve (PP1, PP2 or PP3)	20
7.2 Constant-pressure curve (CP1, CP2 or CP3)	20
7.3 Constant curve (I, II or III)	20
7.4 Overview of the control functions	21
7.5 Selecting control function	22
8. Setting the product	23
8.1 Operating panel	23
8.2 Setting the control function	23
8.3 Connecting the pump to Grundfos GO Remote	25
8.4 Communication, control and monitoring	27
9. Fault finding the product	28
9.1 Grundfos Eye operating status	28
9.2 Resetting a fault indication	29
9.3 Reading out warning and alarm codes in Grundfos GO Remote	29
9.4 Fault finding table	30
9.5 Warning 77, twin-head pump	31
10. Technical data	32
11. Disposing of the product	33



Read this document and the quick guide before installing the product. Installation and operation must comply with local regulations and accepted codes of good practice.



This appliance can be used by children aged from 8 years and above and persons with reduced physical, sensory or mental capabilities or lack of experience and knowledge if they have been given supervision or instruction concerning use of the appliance in a safe way and understand the hazards involved.

Children shall not play with the appliance. Cleaning and user maintenance shall not be made by children without supervision.

1. General information

1.1 Hazard statements

The symbols and hazard statements below may appear in Grundfos installation and operating instructions, safety instructions and service instructions.



DANGER

Indicates a hazardous situation which, if not avoided, will result in death or serious personal injury.



WARNING

Indicates a hazardous situation which, if not avoided, could result in death or serious personal injury.



CAUTION

Indicates a hazardous situation which, if not avoided, could result in minor or moderate personal injury.

The text accompanying the three hazard symbols DANGER, WARNING and CAUTION is structured in the following way:



SIGNAL WORD

Description of hazard

Consequence of ignoring the warning.
- Action to avoid the hazard.

The hazard statements are structured in the following way:

1.2 Notes

The symbols and notes below may appear in Grundfos installation and operating instructions, safety instructions and service instructions.



Observe these instructions for explosion-proof products.



A blue or grey circle with a white graphical symbol indicates that an action must be taken.



A red or grey circle with a diagonal bar, possibly with a black graphical symbol, indicates that an action must not be taken or must be stopped.



If these instructions are not observed, it may result in malfunction or damage to the equipment.



Tips and advice that make the work easier.

1.3 Symbols on the product



Check the position of the clamp before you tighten it. Incorrect position of the clamp will cause leakage from the pump and damage the hydraulic parts in the pump head.



Fit and tighten the screw holding the clamp to 8 Nm \pm 1 Nm.



Do not apply more torque than specified even though water is dripping from the clamp. The condensed water is most likely coming from the drain hole under the clamp.

2. Receiving the product

2.1 Inspecting the product

Check that the product is in accordance with the order. Check that the voltage and frequency of the product match the voltage and frequency of the installation site. See section [6.4.1 Nameplate](#).



Pumps tested with water containing anticorrosive additives are taped on the inlet and outlet ports to prevent residual test water from leaking into the packaging. Remove the tape before installing the pump.

2.2 Scope of delivery

2.2.1 Plug-connected single-head pump



Fig. 1 Plug-connected single-head pump

The box contains the following items:

- MAGNA1 pump
- insulating shells
- gaskets
- quick guide
- safety instructions
- one ALPHA plug.

2.2.2 Plug-connected twin-head pump



Fig. 2 Plug-connected twin-head pump

The box contains the following items:

- MAGNA1 pump
- gaskets
- quick guide
- safety instructions
- two ALPHA plugs.

TM05 5508 3016

TM06 7222 3016

2.2.3 Terminal-connected single-head pump



Fig. 3 Terminal-connected single-head pump

The box contains the following items:

- MAGNA1 pump
- insulating shells
- gaskets
- quick guide
- safety instructions
- box with terminal and cable glands.

2.2.4 Terminal-connected twin-head pump



Fig. 4 Terminal-connected twin-head pump

The box contains the following items:

- MAGNA1 pump
- gaskets
- quick guide
- safety instructions
- two boxes with terminal and cable glands.

2.3 Lifting the product



Observe local regulations concerning limits for manual lifting or handling.

Always lift directly on the pump head or the cooling fins when handling the pump. See fig. 5.

For large pumps, it may be necessary to use lifting equipment. Position the lifting straps as illustrated in fig. 5.

TM06 7223 3016



Fig. 5 Correct lifting of the pump

TM06 6741 3016

TM05 5819 3016



Do not lift the pump head by the control box, i.e. the red area of the pump. See fig. 6.



Fig. 6 Incorrect lifting of the pump

TM06 7219 3016

3. Installing the product

3.1 Location

The pump is designed for indoor installation.

Always install the pump in a dry environment where it will not be exposed to drops or splashes, for example water, from surrounding equipment or structures.

As the pump contains stainless-steel parts, it is important that it is not installed directly in environments, such as:

- Indoor swimming pools where the pump would be exposed to the ambient environment of the pool.
- Locations with direct and continuous exposure to a marine atmosphere.
- In rooms where hydrochloric acid (HCl) can form acidic aerosols escaping from, for example, open tanks or frequently opened or vented containers.

The above applications do not disqualify for installation of MAGNA1. However, it is important that the pump is not installed directly in these environments.

Stainless-steel variants of MAGNA1 can be used to pump pool water. See section [6.3 Pumped liquids](#).

To ensure adequate cooling of the motor and electronics, observe the following requirements:

- Position the pump in such a way that sufficient cooling is ensured.
- The ambient temperature must not exceed 40 °C.

3.2 Tools

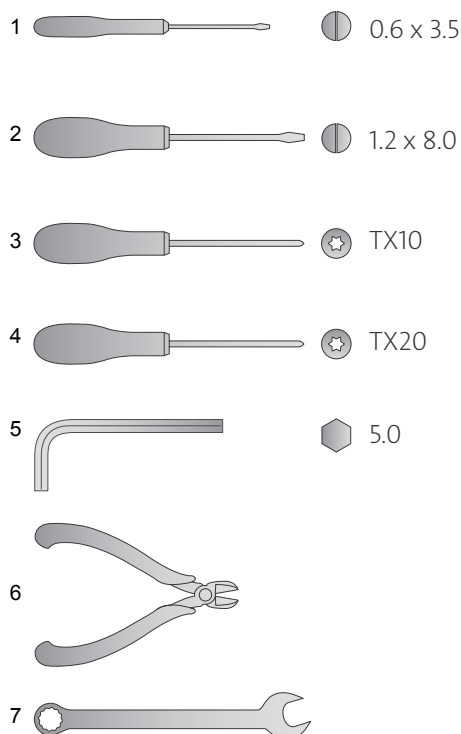

Fig. 7 Recommended tools

Pos.	Tool	Size
1	Screwdriver, straight slot	0.6 x 3.5 mm
2	Screwdriver, straight slot	1.2 x 8.0 mm
3	Screwdriver, torx bit	TX10
4	Screwdriver, torx bit	TX20
5	Hexagon key	5.0 mm
6	Side cutter	
7	Open-end spanner	Depending on DN size

3.3 Insulating shells

Insulating shells limit the heat loss from the pump housing and pipes. Insulating shells are available for single-head pumps only.

3.3.1 Heating systems



Insulating shells increase the pump dimensions.

Insulating shells for pumps in heating systems are factory-fitted with the pump. Remove the insulating shells before you install the pump. See fig. 8.



Fig. 8 Removing insulating shells from the pump

3.3.2 Cooling systems

Insulating shells for pumps in air-conditioning and cooling systems, down to -10 °C, are available as accessories and must be ordered separately. See section [6.8.2 Insulating kits for air-conditioning and cooling systems](#).

3.3.3 Insulating the pump

As an alternative to insulating shells, you can insulate the pump housing and pipes as illustrated in fig. 9.



In heating systems, do not insulate the control box or cover the operating panel.



Fig. 9 Insulation of the pump housing and pipe in a heating system

TM05 6472 4712

TM05 5512 3016





TM05 5549 3016

3.4 Mechanical installation

Install the pump so that it is not stressed by the pipes. For maximum permissible forces and moments from pipe connections acting on the pump flanges, see page 40.

You can suspend the pump directly in the pipes, provided that the pipes support the pump.

Twin-head pumps are prepared for installation on a mounting bracket or base plate.

Step	Action	Illustration
1	Arrows on the pump housing indicate the liquid flow direction through the pump. The liquid flow direction can be horizontal or vertical, depending on the control-box position.	
2	Close the isolating valves and make sure that the system is not pressurised during installation of the pump.	
3	Mount the pump with gaskets in the pipes.	
4	Flanged version: Fit the bolts, washers and nuts. Use the correct size of bolts according to the system pressure. For further information about torques, see page 40.	

TM05 5513 3812

TM06 8040 0317

TM05 5515 3812

TM05 5516 3816

TM05 5517 3812

3.4.1 Pump positions

Always install the pump with horizontal motor shaft.

- Pump installed correctly in a vertical pipe. See fig. 10, pos. A.
- Pump installed correctly in a horizontal pipe. See fig. 10, pos. B.
- Do not install the pump with vertical motor shaft. See fig. 10, pos. C and D.

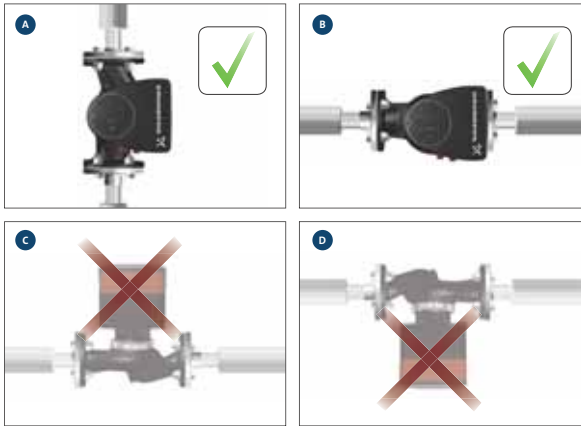

TM05 5518 3016

Fig. 10 Pump installed with horizontal motor shaft

3.4.2 Control box positions

To ensure adequate cooling, make sure that the control box is in horizontal position with the Grundfos logo in vertical position. See fig. 11.



Make sure that the isolating valves are closed before rotating the control box.

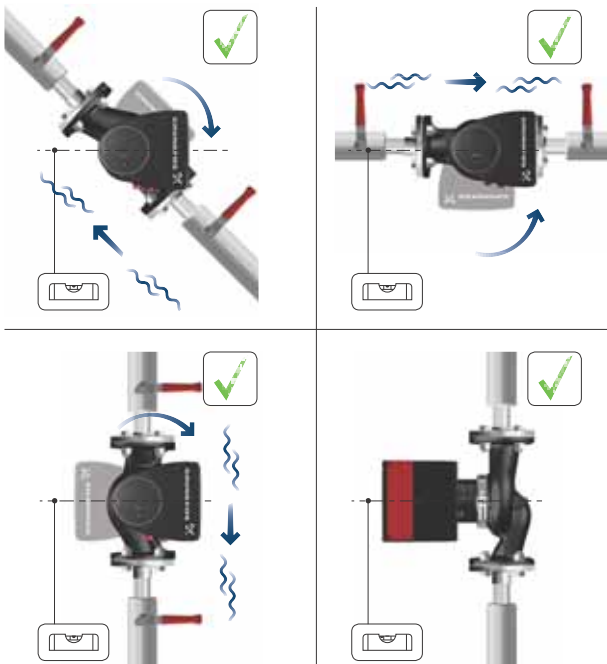

TM05 5522 3016

Fig. 11 Pump with the control box in horizontal position



Twin-head pumps installed in horizontal pipes can be fitted with an automatic vent, Rp 1/4" thread, in the upper part of the pump housing if no venting valve is installed in the system. See fig. 12.



Fig. 12 Automatic vent

TM05 6062 3016

3.4.3 Pump head position

If you remove the pump head before installing the pump in the pipes, pay special attention when fitting the pump head to the pump housing:

1. Visually check that the floating ring in the sealing system is centred. See figs 13 and 14.
2. Gently lower the pump head with the rotor shaft and impeller into the pump housing.
3. Make sure that the contact face of the pump housing and that of the pump head are in contact before you tighten the clamp. See fig. 15.



Fig. 13 Correctly centred sealing system



Fig. 14 Incorrectly centred sealing system

TM05 6650 3016

TM05 6651 3016



Check the position of the clamp before you tighten it. Incorrect position of the clamp will cause leakage from the pump and damage the hydraulic parts in the pump head. See fig. 15.



Fig. 15 Fitting the pump head to the pump housing

TM05 5837 3016

3.4.4 Changing the control box position



The warning symbol on the clamp holding the pump head and pump housing together indicates that there is a risk of personal injury. See specific warnings below.

CAUTION

Pressurised system

Minor or moderate personal injury
 - Pay special attention to any escaping vapour when loosening the clamp.



CAUTION

Crushing of feet

Minor or moderate personal injury
 - Do not drop the pump head when loosening the clamp.



Fit and tighten the screw holding the clamp to 8 Nm ± 1 Nm. Do not apply more torque than specified even though water is dripping from the clamp. The condensed water is most likely coming from the drain hole under the clamp.



Check the position of the clamp before you tighten it. Incorrect position of the clamp will cause leakage from the pump and damage the hydraulic parts in the pump head.



Make sure that the isolating valves are closed before rotating the control box.

Step	Action	Illustration
1	Loosen the screw in the clamp that holds the pump head and pump housing together. If you loosen the screw too much, the pump head will be completely disconnected from the pump housing.	
2	Carefully, turn the pump head to the desired position. If the pump head is stuck, loosen it with a light blow of a rubber mallet.	
3	Place the control box in horizontal position so that the Grundfos logo is in vertical position. The motor shaft must be in horizontal position.	
4	Due to the drain hole in the stator housing, position the gap of the clamp as shown in step 4a or 4b.	
4a	Single-head pump: Position the clamp so that the gap points towards the arrow. It can be in position 3, 6, 9 or 12 o'clock.	

TM05 2867 3016

TM05 5526 3016

TM05 5527 3016

TM05 2870 3016

TM05 2918 3016

Step	Action	Illustration
4b	Twin-head pump: Position the clamps so that the gaps point towards the arrows. They can be in position 3, 6, 9 or 12 o'clock.	
5	Fit and tighten the screw holding the clamp to 8 ± 1 Nm. Do not retighten the screw if condensed water is dripping from the clamp.	
6	Fit the insulating shells. Insulating shells for pumps in air-conditioning and cooling systems must be ordered separately.	

TM05 2917 3016

TM05 2872 3016

TM05 5529 3016

3.5 Electrical connection

Carry out the electrical connection and protection according to local regulations.

Check that the supply voltage and frequency correspond to the values stated on the nameplate.

WARNING



Electric shock

Death or serious personal injury

- Lock the main switch in position 0. Type and requirements as specified in EN 60204-1, 5.3.2.

WARNING

Electric shock

Death or serious personal injury

- Connect the pump to an external main switch with a minimum contact gap of 3 mm in all poles.
- Use earthing or neutralisation for protection against indirect contact.
- If a plug-connected pump is connected to an electric installation where an electrical circuit breaker (voltage sensing ELCB, residual-current device RCD or residual-current circuit device RCCB) is used as an additional protection, this circuit breaker must be marked with the first or both of the symbols shown below.

If the pump is terminal-connected, the circuit breaker must be marked with both of the symbols below.



- Make sure that the pump is connected to an external main switch.
- The pump requires no external motor protection.
- The motor incorporates thermal protection against slow overloading and blocking.
- When switched on via the power supply, the pump starts after approximately 5 seconds.

3.5.1 Supply voltage

1 x 230 V ± 10 %, 50/60 Hz, PE.

The voltage tolerances are intended for mains-voltage variations. Do not use the voltage tolerances for running pumps at other voltages than those stated on the nameplate.

3.5.2 Wiring diagrams

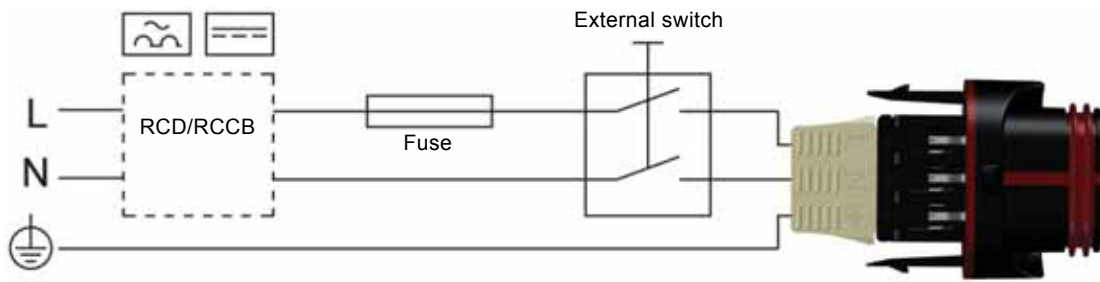

Fig. 16 Example of a plug-connected motor with a main switch, backup fuse and additional protection

TM05 5277 3016

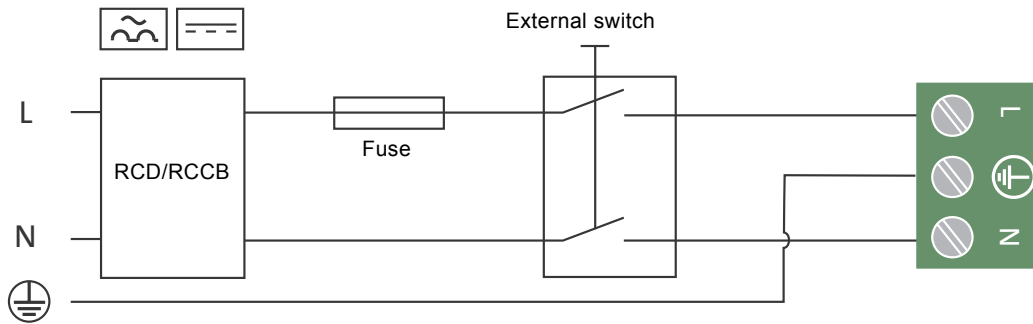

Fig. 17 Example of a mains-connected motor with a main switch, backup fuse and additional protection

TM06 8503 0817

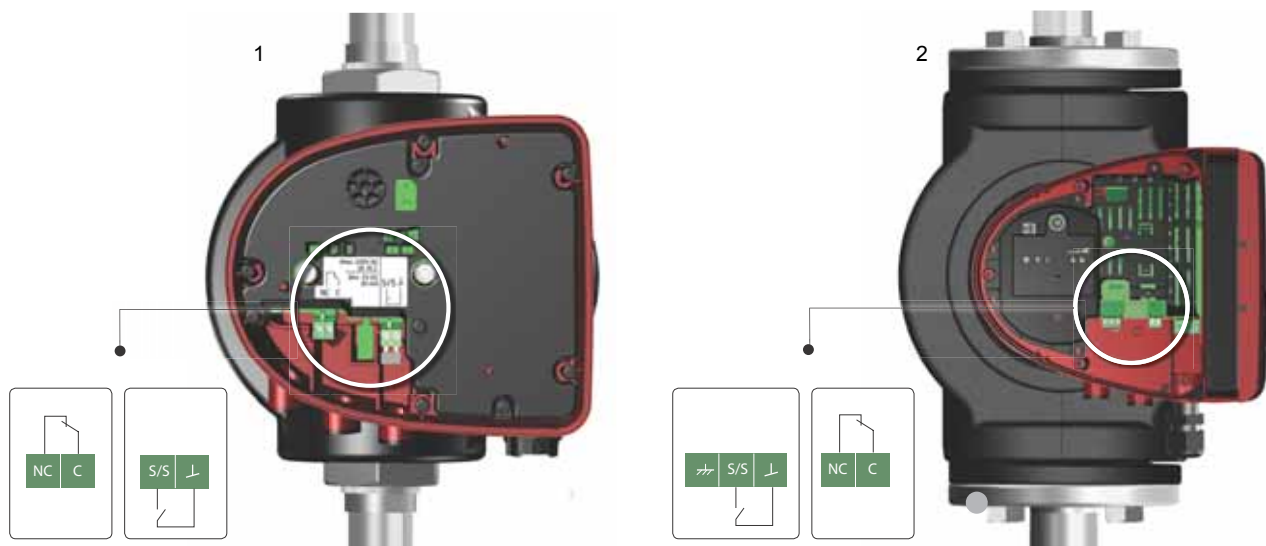

Fig. 18 Connection to external control

TM06 9106 4517 - TM06 8060 0717

Pos.	Description
1	Plug-connected versions
2	Terminal-connected versions

WARNING

Electric shock

Minor or moderate personal injury
 - Separate wires connected to supply terminals, outputs NC, C and start-stop input from each other and from the supply by means of reinforced insulation.



Make sure that the fuse is dimensioned according to the nameplate and local regulations.



Connect all cables in accordance with local regulations.



Make sure that all cables are heat-resistant up to 75 °C.
 Install all cables in accordance with EN 60204-1 and EN 50174-2:2000.

3.5.3 Connection to the power supply, plug-connected versions

Step	Action	Illustration
1	Fit the cable gland and plug cover to the cable. Strip the cable conductors as illustrated.	
2	Connect the cable conductors to the power supply plug.	
3	Bend the cable with the cable conductors pointing upwards.	
4	Pull out the conductor guide plate and throw it away.	
5	Click the plug cover onto the power supply plug.	
6	Screw the cable gland onto the power supply plug.	

Step	Action	Illustration
7	Insert the power supply plug into the male plug in the pump control box.	

Disassembling the plug

Step	Action	Illustration
1	Loosen the cable gland and remove it from the plug.	
2	Pull off the plug cover while pressing on both sides.	
3	Loosen the cable conductors one by one by pressing a screwdriver gently into the terminal clip.	
4	The plug has now been removed from the power supply plug.	

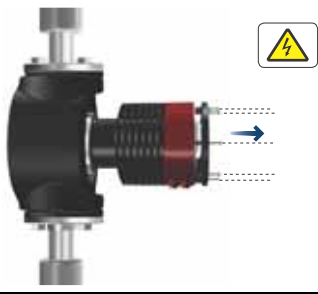
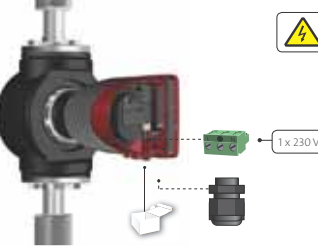
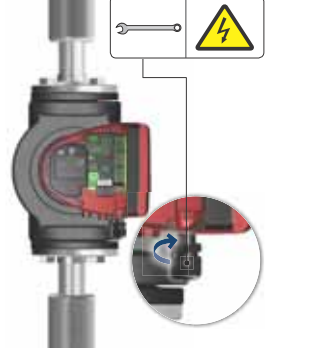
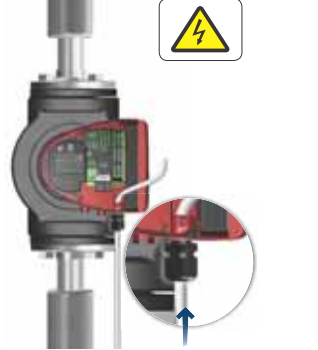
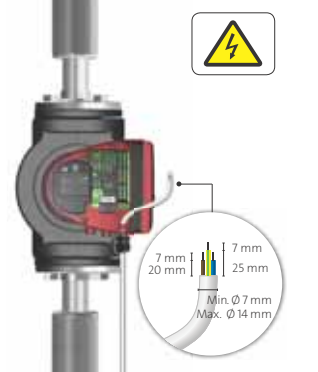

3.5.4 Connection to the power supply, terminal-connected version

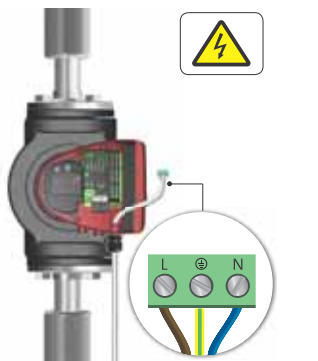
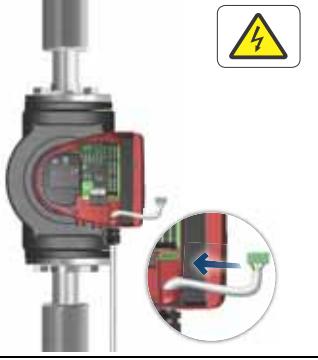
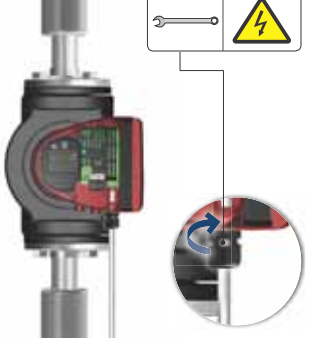
Step	Action	Illustration
1	Remove the front cover from the control box. Do not remove the screws from the cover.	
2	Locate the power supply plug and cable gland in the small cardboard box supplied with the pump.	
3	Connect the cable gland to the control box.	
4	Pull the power cable through the cable gland.	
5	Strip the cable conductors as illustrated.	

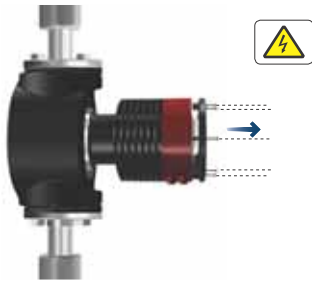

Step	Action	Illustration
6	Connect the cable conductors to the power supply plug.	
7	Insert the power supply plug into the male plug in the control box.	
8	Tighten the cable gland. Refit the front cover.	

3.5.5 Connecting the digital input

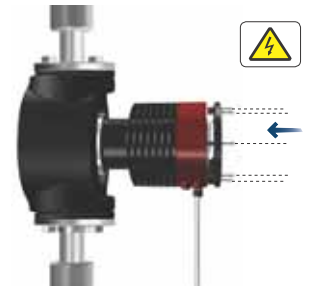
The example is based on a MAGNA1 terminal-connected version. The connection terminals of plug-connected versions differ from those of terminal-connected versions, but they have the same function and connection options. See sections [3.5.2 Wiring diagrams](#) and [8.4 Communication, control and monitoring](#).

Step	Action	Illustration
1	Remove the front cover from the control box. Do not remove the screws from the cover.	
2	Locate the digital input terminal connector.	
3	Pull the cable through a cable gland, M16, and connect the cable conductors to the digital input terminal connector. See section 8.4.1 Digital input (Start/Stop) for instructions on how to connect the cable to the terminal.	
4	Refit the front cover to the control box.	

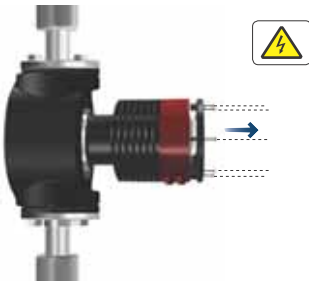
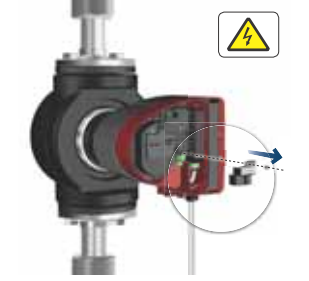
3.5.6 Connecting the fault relay output

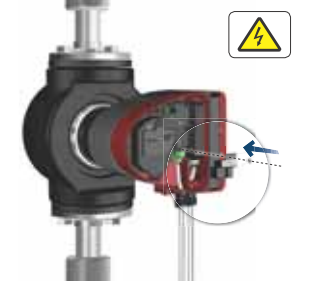
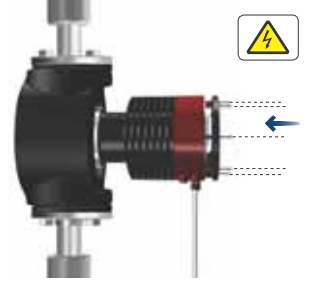
Step	Action	Illustration
1	Remove the front cover from the control box. Do not remove the screws from the cover.	
2	Locate the fault relay output cover and remove it.	
3	Pull the cable through a cable gland, M16, and connect the cable conductors to the fault relay output terminal connector. See section 8.4.2 Fault relay output for instructions on how to connect the cable to the terminal.	
4	Refit the fault relay output cover.	
5	Refit the front cover to the control box.	

4. Starting up the product

4.1 Single-head pump



In order to protect the electronics, the number of starts and stops must not exceed four times per hour.

Do not start the pump until the system has been filled with liquid and vented. Furthermore, the required minimum inlet pressure must be available at the pump inlet. See section [10. Technical data](#).

The pump is self-venting through the system, and the system must be vented at the highest point.

Step	Action	Illustration
1	Switch on the power supply to the pump. The pump starts after approximately 5 seconds.	<p>1 x 230 V ± 10% -50/60 Hz Ⓢ</p> <p>1 / On</p> <p>0 / Off</p> <p>TM07 0033 3917</p>
2	Operating panel at first startup.	<p>TM05 5551 3016</p>
3	The pump has been factory-set to the intermediate proportional-pressure curve. Select the control mode according to the system application by pressing the button . See section 7. Control functions and 8. Setting the product .	<p>TM05 5551 3016</p>

4.2 Twin-head pump



Make sure that both pump heads are powered on.

The pumps are paired from factory. When switching on the power supply, the heads will establish connection, which is indicated by a green light in the centre of Grundfos Eye. Please allow approximately 5 seconds for this to happen.

If one of the pump heads is turned off, the pump with power will show a yellow indicator light, warning 77, see section 9. [Fault finding the product](#). In that case, power up the switched off pump. Once both pumps are on, the pumps will establish connection and the warning deactivates.

See sections [8.4.1 Digital input \(Start/Stop\)](#), [8.4.2 Fault relay output](#) and [8.4.3 Twin-head pump function](#) for additional twin-head pump setup options.

4.3 Pairing and unpairing twin-head pumps

The pumps are paired from factory, however, it can be useful to know how to pair the system e.g. for service purposes.

The pumps can also be unpaired.



When you have paired the pumps, you must wait 10 seconds before unpairing.

4.3.1 Pairing



The master pump head is the one from which you initiate the pairing.

Step	Action	Illustration
1	Push and hold the button on the pump you wish to assign as the master pump for 5 seconds. The centre of Grundfos Eye on both pumps will begin to flash.	TM06 8524 1017
2	Push the button on the other pump to assign this as the slave pump.	TM06 8525 1017
3	The centre of both Grundfos Eye indicator lights are alight and constant. The two pumps are now paired.	TM06 8527 1017

4.3.2 Unpairing

Step	Action	Illustration
1	Push and hold the button on any of the two pump heads for 5 seconds.	TM06 8521 1017
2	The light in the centre of Grundfos Eye will disappear. The system has been deactivated.	TM06 8522 1017

5. Handling and storing the product



If the pump is not used during periods of frost, add antifreeze or let the pump run in regular intervals to prevent frost bursts.



Observe local regulations concerning limits for manual lifting or handling.

Always lift directly on the pump head or the cooling fins when handling the pump. For large pumps, it may be necessary to use lifting equipment. See section [2.3 Lifting the product](#).

6. Product introduction

6.1 Product description

Grundfos MAGNA1 is a complete range of circulator pumps with integrated controller enabling adjustment of pump performance to the actual system requirements. In many systems, this reduces the power consumption considerably, reduces noise from thermostatic radiator valves and similar fittings and improves the control of the system.

You can set the desired head on the operating panel.

6.2 Intended use

The pump is designed for circulating liquids in the following systems:

- heating systems
- domestic hot-water systems
- air-conditioning and cooling systems.

You can also use the pump in the following systems:

- ground-source heat-pump systems
- solar-heating systems.

6.3 Pumped liquids

The pump is suitable for thin, clean, non-aggressive and non-explosive liquids, not containing solid particles or fibres that may attack the pump mechanically or chemically.

In heating systems, the water must meet the requirements of accepted standards on water quality in heating systems, for example the German standard VDI 2035.

The pump is also suitable for domestic hot-water systems.



Observe local regulations regarding pump-housing material.

Stainless-steel variants of MAGNA1 can be used to pump pool water with one of the following properties:

- Chloride (Cl-) ≤ 150 mg/l and free chlorine ≤ 1.5 mg/l at temperatures ≤ 30 degrees Celsius
- Chloride (Cl-) ≤ 100 mg/l and free chlorine ≤ 1.5 mg/l at temperatures from 30 to 40 degrees Celsius.

We strongly recommend that you use stainless-steel pumps in domestic hot-water applications to avoid corrosion.

In domestic hot-water systems, we recommend that you use the pump only for water with a degree of hardness lower than approximately 14 °dH.

In domestic hot-water systems, we recommend that you keep the liquid temperature below 65 °C to eliminate the risk of lime precipitation.



Do not pump aggressive liquids.



Do not pump flammable, combustible or explosive liquids.

6.3.1 Glycol

You can use the pump for pumping water-ethylene-glycol mixtures up to 50 %.

Example of a water-ethylene-glycol mixture:

Maximum viscosity: 50 cSt ~ 50 % water and 50 % glycol mixture at -10 °C.

The pump has a power-limiting function that protects it against overload.

The pumping of glycol mixtures affects the maximum curve and reduces the performance, depending on the water-ethylene-glycol mixture and the liquid temperature.

To prevent the glycol mixture from degrading, avoid temperatures exceeding the rated liquid temperature and minimise the operating time at high temperatures.

Clean and flush the system before you add the glycol mixture.

To prevent corrosion or lime precipitation, maintain the glycol mixture regularly. If further dilution of the supplied glycol is required, follow the glycol supplier's instructions.



Additives with a density or kinematic viscosity higher than water reduces the hydraulic performance.

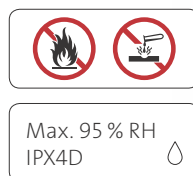

TM06 8055 0717

Fig. 19 Pumped liquids

6.4 Identification

6.4.1 Nameplate

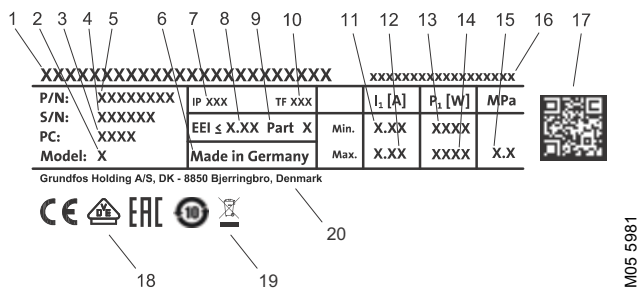

Fig. 20 Example of a nameplate

Pos.	Description
1	Product name
2	Model
3	Production code, PC, year and week*
4	Serial number
5	Product number
6	Country of manufacture
7	Enclosure class
8	Energy Efficiency Index, EEI
9	Part, according to EEI
10	Temperature class
11	Minimum current [A]
12	Maximum current [A]
13	Minimum power [W]
14	Maximum power [W]
15	Maximum system pressure
16	Voltage [V] and frequency [Hz]
17	QR code
18	CE mark and approvals
19	Crossed-out wheeled bin according to EN 50419:2006
20	Manufacturer's name and address

* Example of production code: 1326. The pump was produced in week 26, 2013.



Fig. 21 Production code on the packaging

6.4.2 Type key

Code Example	MAGNA1	D	80	-120	(F)	(N)	360
Type range MAGNA1							
D Twin-head pump							
Nominal diameter (DN) of inlet and outlet ports [mm]							
Maximum head [dm]							
Pipe connection Threaded F Flange							
Pump housing material Cast iron N Stainless steel							
Port-to-port length [mm]							

6.5 Radio communication

MAGNA1 single-head pumps are designed for infrared communication (IR) with Grundfos GO Remote, while MAGNA1 twin-head pumps can also communicate via radio.

6.6 Non-return valve

If a non-return valve is fitted in the pipe system, ensure that the set minimum outlet pressure of the pump is always higher than the closing pressure of the valve. See fig. 22. This is especially important in proportional-pressure control mode with reduced head at a low flow rate.



Fig. 22 Non-return valve

6.7 Closed valve operation

MAGNA1 pumps can operate at any speed against a closed valve for several days without damage to the pump. However, Grundfos recommends to operate at the lowest possible speed curve to minimize energy losses. There are no minimum flow requirements.



Do not close inlet and outlet valves simultaneously, always keep one open when the pump is running. Media- and ambient temperatures must never exceed the specified temperature range.

6.8 Accessories

6.8.1 Insulating shells for heating systems

Insulating shells are available for single-head pumps only and are supplied with the pump.



Insulating shells increase the pump dimensions.

6.8.2 Insulating kits for air-conditioning and cooling systems

Insulating shells for pumps in air-conditioning and cooling systems, down to -10 °C, are available as accessories and must be ordered separately. A kit consists of two shells made of polyurethane and a self-adhesive seal to ensure tight assembly.



Insulating shells increase the pump dimensions. The dimensions of the insulating shells for pumps in air-conditioning and cooling systems differ from those of the insulating shells for pumps in heating systems.

Pump type	Product number
MAGNA1 25-40/60/80/100/120 (N)	98538852
MAGNA1 32-40/60/80/100/120 (N)	98538853
MAGNA1 32-40/60/80/100 F (N)	98538854
MAGNA1 32-120 F (N)	98164595
MAGNA1 40-40/60 F (N)	98538855
MAGNA1 40-80/100 F (N)	98164597
MAGNA1 40-120/150/180 F (N)	98164598
MAGNA1 50-60/80 F (N)	98164599
MAGNA1 50-100/120/150/180 F (N)	98164600
MAGNA1 65-40/60/80/100/120/150 F (N)	98538839
MAGNA1 80-60/80/100/120 F	98538851
MAGNA1 100-40/60/80/100/120 F	98164611



The insulating kit also fits stainless-steel versions (N).

6.8.3 Blanking flanges

A blanking flange is used to blank off the opening when one of the pump heads of a twin-head pump is removed for service to enable uninterrupted operation of the other pump.

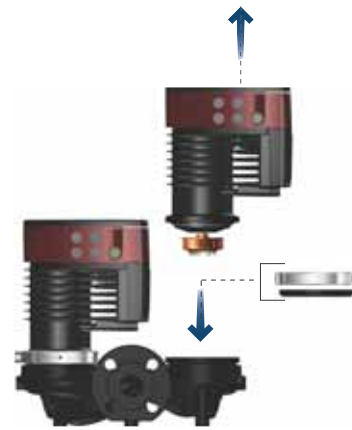

Fig. 23 Position of a blanking flange

Pump type	Product number
MAGNA1 D 25-40/60/80/100/120	
MAGNA1 D 32-40/60/80/100 (F)	98159373
MAGNA1 D 40-40/60 F	
MAGNA1 D 32-120 F	
MAGNA1 D 40-80/100/120/150/180 F	
MAGNA1 D 50-60/80/100/120/150/180 F	
MAGNA1 D 65-40/60/80/100/120/150 F	98159372
MAGNA1 D 80-60/80/100/120 F	
MAGNA1 D 100-40/60/80/100/120 F	

6.8.4 Counterflanges

Counterflange kits consist of two flanges, two gaskets and bolts and nuts, making it possible to install the pump in any pipes. See New MAGNA1 model C data booklet, Accessories section, for the right dimension and product number.

TM06 8518 0817

6.8.5 Grundfos GO Remote

MAGNA1 single-head pumps are designed for infrared communication (IR) with Grundfos GO Remote, while MAGNA1 twin-head pumps can also communicate via radio.



The radio communication between the pump and Grundfos GO Remote is encrypted to protect against misuse.

In order to communicate with Grundfos GO Remote via infrared, you need an add-on module. Two variants are available as described in the following.

MI 204

MI 204 is an add-on module with built-in infrared and radio communication. You can use MI 204 in conjunction with an Apple iPhone or iPod with Lightning connector.



Fig. 24 MI 204

Supplied with the product:

- Grundfos MI 204
- sleeve
- quick guide
- charger cable.

MI 301

MI 301 is a module with built-in infrared and radio communication. Use MI 301 in conjunction with an Android or iOS-based smart device with a Bluetooth connection. MI 301 has a rechargeable Li-ion battery and must be charged separately.



Fig. 25 MI 301

Supplied with the product:

- Grundfos MI 301
- battery charger
- quick guide.

Product numbers

Grundfos GO variant	Product number
Grundfos MI 204	98424092
Grundfos MI 301	98046408

Together with the Grundfos GO module, you will need to download the Grundfos GO Remote app, which is available in Apple App Store and Google Play.

For function and connection to the pump, see the separate installation and operating instructions for the desired type of Grundfos GO setup.

7. Control functions



Factory setting: Intermediate proportional-pressure curve, referred to as PP2.

7.1 Proportional-pressure curve (PP1, PP2 or PP3)

Proportional-pressure control adjusts the pump performance to the actual flow rate demand in the system, but the pump performance follows the selected performance curve, PP1, PP2 or PP3. See fig. 26 where PP2 has been selected.

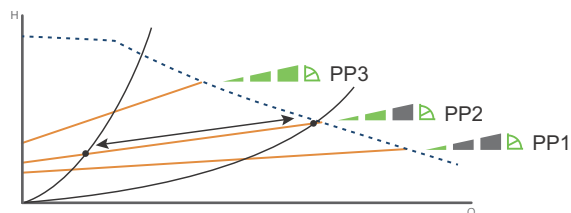

Fig. 26 Three proportional-pressure curves and settings

The selection of the right proportional-pressure setting depends on the characteristics of the system in question and the actual flow rate demand.

For further information, see section 7.4 *Overview of the control functions* and 7.5 *Selecting control function*.

7.2 Constant-pressure curve (CP1, CP2 or CP3)

Constant-pressure control adjusts the pump performance to the actual flow rate demand in the system, but the pump performance follows the selected performance curve, CP1, CP2 or CP3. See fig. 27 where CP1 has been selected.

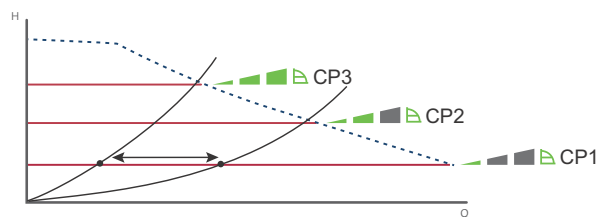

Fig. 27 Three constant-pressure curves and settings

The selection of the right constant-pressure setting depends on the characteristics of the system in question and the actual flow rate demand.

For further information, see section 7.4 *Overview of the control functions* and 7.5 *Selecting control function*.

7.3 Constant curve (I, II or III)

At constant-curve operation, the pump runs at a constant speed, independently of the actual flow rate demand in the system. The pump performance follows the selected performance curve, I, II or III. See fig. 28 where II has been selected.

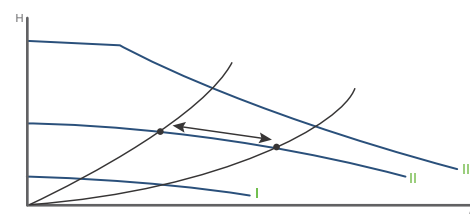
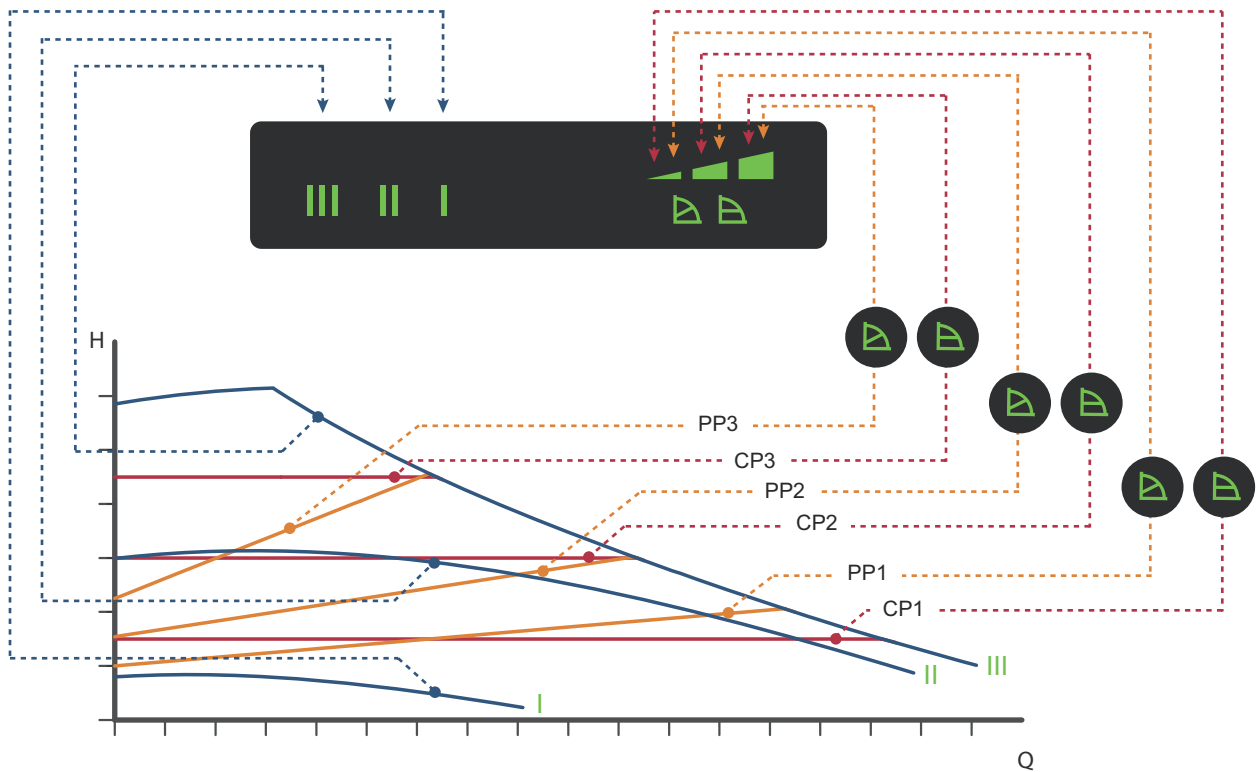

Fig. 28 Three constant-curve settings

The selection of the right constant-curve setting depends on the characteristics of the system in question.

For further information, see section 7.4 *Overview of the control functions* and 7.5 *Selecting control function*.

7.4 Overview of the control functions



TM05 2778 3617

Fig. 29 Control function in relation to system requirements

Setting	Pump curve	Function
PP1	Lowest proportional-pressure curve	The duty point of the pump will move up or down on the lowest proportional-pressure curve, depending on the flow rate demand. The head is reduced at falling flow rate demand and increased at rising flow rate demand.
PP2	Intermediate proportional-pressure curve	The duty point of the pump will move up or down on the intermediate proportional-pressure curve, depending on the flow rate demand. The head is reduced at falling flow rate demand and increased at rising flow rate demand.
PP3	Highest proportional-pressure curve	The duty point of the pump will move up or down on the highest proportional-pressure curve, depending on the flow rate demand. The head is reduced at falling flow rate demand and increased at rising flow rate demand.
CP1	Lowest constant-pressure curve	The duty point of the pump will move out or in on the lowest constant-pressure curve, depending on the flow rate demand in the system. The head is kept constant, irrespective of the flow rate demand.
CP2	Intermediate constant-pressure curve	The duty point of the pump will move out or in on the intermediate constant-pressure curve, depending on the flow rate demand in the system. The head is kept constant, irrespective of the flow rate demand.
CP3	Highest constant-pressure curve	The duty point of the pump will move out or in on the highest constant-pressure curve, depending on the flow rate demand in the system. The head is kept constant, irrespective of the flow rate demand.
III	Speed III	The pump runs on a constant curve which means that it runs at a constant speed. At speed III, the pump is set to run on the maximum curve under all operating conditions. You obtain quick venting of the pump by setting the pump to speed III for a short period.
II	Speed II	The pump runs on a constant curve which means that it runs at a constant speed. At speed II, the pump is set to run on the intermediate curve under all operating conditions.
I	Speed I	The pump runs on a constant curve which means that it runs at a constant speed. At speed I, the pump is set to run on the minimum curve under all operating conditions.

7.5 Selecting control function

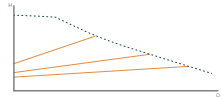
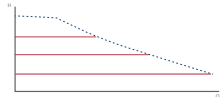
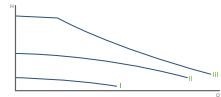
System application	Select this control mode
<p>Systems with relatively large pressure losses in the distribution pipes and in air-conditioning and cooling systems.</p> <ul style="list-style-type: none"> • Two-pipe heating systems with thermostatic valves and the following: <ul style="list-style-type: none"> – very long distribution pipes – strongly throttled pipe-balancing valves – differential-pressure regulators – large pressure losses in those parts of the system through which the total quantity of water flows, for example a boiler, a heat exchanger and a distribution pipe up to the first branching. • Primary circuit pumps in systems with large pressure losses in the primary circuit. • Air-conditioning systems with the following: <ul style="list-style-type: none"> – heat exchangers, fan coils – cooling ceilings – cooling surfaces. 	<p style="text-align: center;">Proportional pressure</p> 
<p>Systems with relatively small pressure losses in the distribution pipes.</p> <ul style="list-style-type: none"> • Two-pipe heating systems with thermostatic valves and the following: <ul style="list-style-type: none"> – dimensioning for natural circulation – small pressure losses in those parts of the system through which the total quantity of water flows, for example a boiler, a heat exchanger and a distribution pipe up to the first branching or modified to a high differential temperature between the flow pipe and the return pipe, for example district heating. • Underfloor heating systems with thermostatic valves. • One-pipe heating systems with thermostatic valves or pipe-balancing valves. • Primary circuit pumps in systems with small pressure losses in the primary circuit. 	<p style="text-align: center;">Constant pressure</p> 
<p>Operation according to the maximum or minimum curve, like an uncontrolled pump:</p> <ul style="list-style-type: none"> • Use the maximum-curve mode in periods in which a maximum flow rate is required. This operating mode is for instance suitable for hot-water priority in domestic hot-water systems. • Use the minimum-curve mode in periods in which a minimum flow rate is required. 	<p style="text-align: center;">Constant curve</p> 

8. Setting the product

8.1 Operating panel

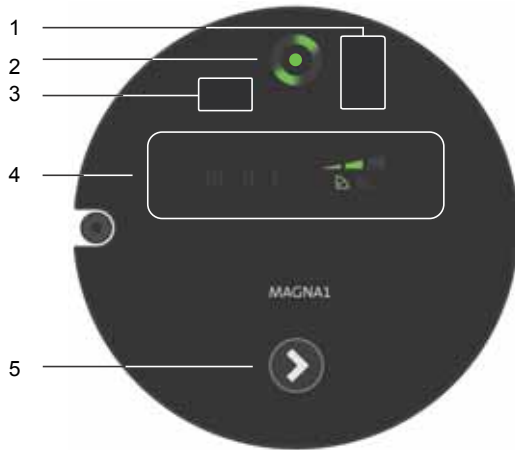
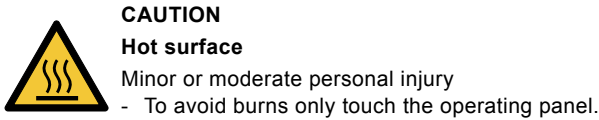

TM06 9078 3617









Fig. 30 Operating panel

The operating panel on the pump comprises the following:

Pos.	Description
1	Infrared receiver for Grundfos GO. Plug-connected versions.
2	Grundfos Eye. See section 9.1 Grundfos Eye operating status .
3	Infrared receiver for Grundfos GO. Terminal-connected versions.
4	LEDs indicate the control function. See section 8.2 Setting the control function .
5	Push-button for selection of a control function.

8.2 Setting the control function

The pump has nine control functions, see section [7. Control functions](#). Select the control function by pressing the push-button on the operating panel, see [fig. 30](#), pos. 5. The control function is indicated by eight different light fields in the display.

Button presses	Active light fields	Description
0		Intermediate proportional-pressure curve, referred to as PP2, factory setting
1		Highest proportional-pressure curve, referred to as PP3
2		Lowest constant-pressure curve, referred to as CP1
3		Intermediate constant-pressure curve, referred to as CP2
4		Highest constant-pressure curve, referred to as CP3
5		Constant curve III
6		Constant curve II
7		Constant curve I
8		Lowest proportional-pressure curve, referred to as PP1



8.2.1 Adjusting the proportional pressure using Grundfos GO Remote

The setpoint of the proportional-pressure curve can be adjusted using Grundfos GO Remote.

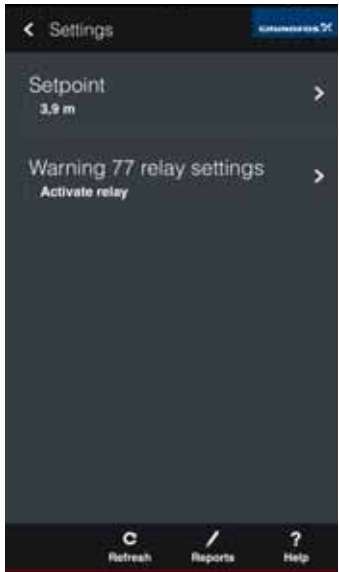

Adjusting the proportional pressure is only possible in proportional pressure mode.

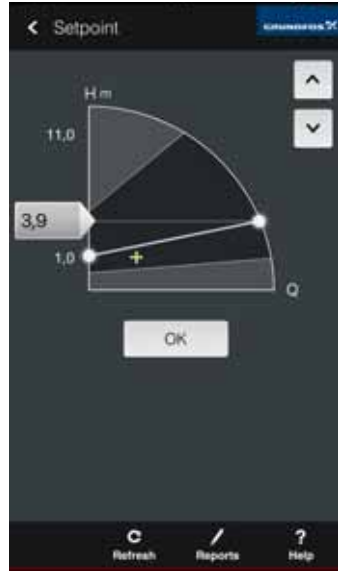
Step	Action	Illustration
1	Choose "Settings" in the Grundfos GO Remote dashboard.	 <p style="text-align: right; font-size: small;">TM06 8584 0817</p>
2	Choose "Setpoint" in the "Settings" menu.	 <p style="text-align: right; font-size: small;">TM06 8583 0817</p>

Step	Action	Illustration
3	Use the arrows on the top right of the screen, or slide the setpoint indicator up and down to adjust the setpoint. Press "OK".	 <p style="text-align: right; font-size: small;">TM06 8582 0817</p>
4	When the pump receives the setpoint from Grundfos GO Remote, the proportional-pressure symbol on the pump lights up - none of the level indicators lights up.	

For instructions on how to connect the pump to Grundfos GO Remote, see section [8.3 Connecting the pump to Grundfos GO Remote](#).

8.3 Connecting the pump to Grundfos GO Remote

MAGNA1 single-head pumps are designed for infrared communication (IR) with Grundfos GO Remote, while MAGNA1 twin-head pumps can also communicate via radio.

Before connecting to Grundfos GO Remote

To use Grundfos GO Remote together with MAGNA1 make sure to have the following ready:

- For IR communication: A Grundfos GO add-on module, which is available as an accessory. See section [6.8.5 Grundfos GO Remote](#). See the separate installation and operating instructions for the desired type of Grundfos GO setup.
- The Grundfos GO Remote app downloaded to your smart device. Grundfos GO Remote is available in Apple App Store and Google Play.

Connecting to Grundfos GO Remote

To connect to Grundfos GO Remote, do as follows:

1. For IR communication: Establish a connection between the Grundfos GO add-on module and your smart device. See the separate installation and operating instructions.
2. Open the Grundfos GO Remote app and select either IR or radio communication depending on the pump type and chosen communication method. Make sure to point Grundfos GO at the receiver placed left or right to Grundfos Eye depending on your pump model. See fig. [31](#).



Fig. 31 Establishing a connection between Grundfos GO and MAGNA1 via infrared communication

8.3.1 Using Grundfos GO Remote



Fig. 32 Grundfos GO Remote dashboard

Pos.	Description
1	Information about the connected product.
2	Grundfos Eye reflecting the current operating status of the pump.
3	In a multipump system: Icon indicating if Grundfos GO is connected to the master or slave pump. When connected to a single pump: The field is empty.
4	The actual, measured head (pressure).
5	The power consumption of the pump.
6	Main menu. See sections 8.3.2 "Status" menu , 8.3.3 "Settings" menu and 8.3.4 "Alarms and warnings" menu .
7	"Disconnect": Disconnects Grundfos GO from the pump. "Refresh": Retrieves current data from the pump. "Reports": Wizard creating a report with the pump's current operating status and settings. "Help": Guides you through the app.



When using Grundfos GO in a multipump setup and choosing "system view", Grundfos Eye, pos. 2, fig. [32](#), will indicate the system's operating status and not the status of the pump itself. See section [9.1.1 Multipump system operating indications](#).

TM06 8584 0817

TM06 9081 3617

TM06 7653 0718

8.3.2 "Status" menu

The "Status" menu gives an overview of the pump's current operating status. To access the menu, connect the pump to Grundfos GO. See section [4.3 Pairing and unpairing twin-head pumps](#), and choose the "Status" menu from the dashboard.

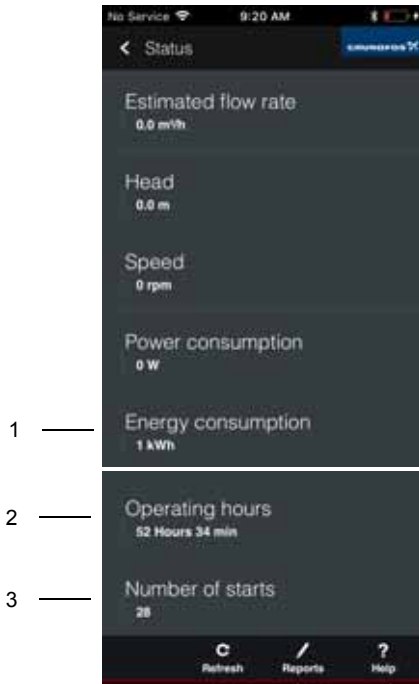

status menu 1 - status menu 2

Fig. 33 "Status" menu

Pos.	Description
1	The accumulated energy consumption. This cannot be reset.
2	The amount of time the product has been operating. This is an accumulated value that cannot be reset.
3	The total number of times the pump has been started since installation.

8.3.3 "Settings" menu

The "Settings" menu allows you to:

- Adjust the proportional pressure, see section [8.2.1 Adjusting the proportional pressure using Grundfos GO Remote](#) for instructions.
- Configure the Warning 77 relay setting, see section [9.5.1 Activating and deactivating the fault relay](#) for instructions.

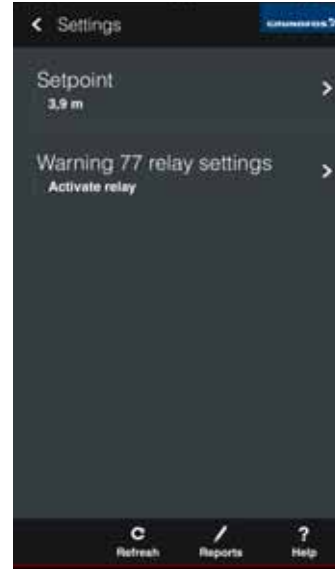

Fig. 34 "Settings" menu

TM06 8583 0817

8.3.4 "Alarms and warnings" menu

This menu lets you read out alarm codes and text. A log history of previous alarms and warnings is also available.



Fig. 35 "Alarms and warnings" menu with alarm

Alarm_Warning

For more information on warnings and alarms, see section [9. Fault finding the product](#).



You can also reach the menu by tapping Grundfos Eye on the dashboard, see pos. 2, fig. [32](#).

8.4 Communication, control and monitoring

MAGNA1 enables external control and monitoring via the Start/Stop input, see section 8.4.1 *Digital input (Start/Stop)*, and the fault relay output, see section 8.4.2 *Fault relay output*, on both single and twin-head pumps. In addition, the wireless communication feature in twin-head pumps lets you use the pump without an external controller, see section 8.4.3 *Twin-head pump function*.

8.4.1 Digital input (Start/Stop)

To use the digital input, connect the control wires to terminals Start/Stop (S/S) and frame (⊥).



If no external on and off switch is connected, maintain the jumper between terminals Start/Stop (S/S) and frame (⊥). This connection is the factory setting.



Fig. 36 Digital input in the control box
A: Plug-connected versions
B: Terminal-connected versions

Contact symbol	Function
S/S	Start/Stop
⊥	Frame connection
⌞	Cable shield

! Plug-connected versions, pos. A, fig. 36:
When using a shielded cable, connect the shield in the frame terminal (⊥) together with the frame connection cord.

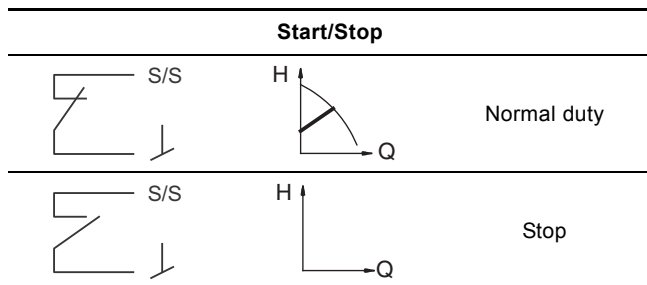

For instructions on how to connect to the Start/Stop input, see section 3.5.5 *Connecting the digital input*.

Digital input on twin-head pumps

The Start/Stop input operates on system level, meaning that if the master pump head receives a stop signal, the system stops. As a main rule the digital input is only effective on the master, which is why it is important to know which pump is assigned as the master, see fig. 37.



Fig. 37 Identifying the master pump head on the nameplate

For redundancy purposes, the digital input can be used concurrent on the slave pump head. However, as long as the master is powered up, the input on the slave will be ignored. In the event of power loss on the master, the digital input of the slave will take over. When the master pump head is back on, the master takes over and controls the slave.

8.4.2 Fault relay output

The fault relay has a potential-free changeover contact for external fault indication. See section 3.5.2 *Wiring diagrams*. It is possible to use the relay output as part of a control strategy or for monitoring. For example, if the pump experiences a fault, the fault relay sends a signal to the controller, which will subsequently trigger further events depending on your chosen strategy. In order to use the fault relay output, follow the instructions in fig. 38.

The relay can be used for outputs up to 250 V and 2 A. Factory settings of the relay:



Contact symbol	Function
NC	Normally closed
C	Common

The functions of the fault relay are as shown in the table:

Fault relay	Alarm signal
	Not activated: <ul style="list-style-type: none"> The power supply has been switched off. The pump has not registered a fault.
	Activated: <ul style="list-style-type: none"> The pump has registered a fault or there is a wirebreak.

Fig. 38 Fault relay output table

For instructions on how to connect to the fault relay output, see section 3.5.6 *Connecting the fault relay output*.

Fault relay output in twin-head pumps

The fault relay output on each pump head operates independently, meaning that if a fault occurs in one of the pumps its respective relay is triggered.

TM06 9107 4617 - TM06 9080 3617

TM06 8063 0817

TM06 9107 4617

8.4.3 Twin-head pump function

The twin-head pump function allows you to use twin-head pumps without an external controller, as the two pump heads communicate via wireless connection.

Operating mode

The pumps are operating in alternating mode, meaning that only one pump is running at a time. The two pumps change from one pump to the other every 24 hours with a tolerance of $\pm 0.5\%$ per day.

To control the twin-head pump via the digital Start/Stop input, see section [8.4.1 Digital input \(Start/Stop\)](#).

To monitor the twin-head pump via the fault relay output, see section [3.5.6 Connecting the fault relay output](#).







9. Fault finding the product

9.1 Grundfos Eye operating status

Grundfos Eye is on when you switch on the power supply.

Grundfos Eye is an indicator light providing information about the actual pump status. A fault is indicated by a yellow or red indicator light in Grundfos Eye on the operating panel and in Grundfos GO Remote.

The indicator light flashes in different sequences and provides information about the following:

Grundfos Eye	Indication	Cause	Operational state
	No lights are on.	The power is off.	The pump is not running.
	Two opposite green indicator lights running in the direction of rotation of the pump.	The power is on.	The pump is running.
	Two opposite green indicator lights are permanently on.	The power is on.	The pump has stopped.
	One yellow indicator light running in the direction of rotation of the pump.	Warning. See section 9. Fault finding the product .	The pump is running.
	One yellow indicator light is permanently on.	Warning. See section 9. Fault finding the product .	The pump has stopped.
	Two opposite red indicator lights flashing simultaneously.	Alarm. See section 9. Fault finding the product .	The pump has stopped.



If the pump impeller is rotated, for example when filling the pump with water, sufficient energy may be generated to light up the operating panel even if the power supply has been switched off.

9.1.1 Multipump system operating indications

When connecting Grundfos GO Remote to a multipump setup and choosing "system view", Grundfos GO Remote will indicate the system's operating status and not the status of the pump itself. Therefore the indicator light in Grundfos GO Remote might differ from the indicator light shown on the pump's operating panel. See the table below.

Grundfos Eye, master pump	Grundfos Eye, slave pump	Grundfos Eye, Grundfos GO Remote
Green	Green	Green
Green or yellow	Yellow or red	Yellow
Yellow or red	Green or yellow	Yellow
Red	Red	Red

9.2 Resetting a fault indication

To reset a fault indication, eliminate the fault cause, see section [9.4 Fault finding table](#), and reset the pump by pressing the button on the pump. If the pump does not revert to normal duty, the fault cause is not eliminated.

If the fault disappears by itself, the fault indication is automatically reset.

A fault can also be reset by using Grundfos GO Remote. See section [9.3 Reading out warning and alarm codes in Grundfos GO Remote](#).

CAUTION

Pressurised system



Minor or moderate personal injury

- Before dismantling the pump, drain the system or close the isolating valve on either side of the pump. The pumped liquid may be scalding hot and under high pressure.

WARNING

Electric shock



Death or serious personal injury

- Switch off the power supply for at least 3 minutes before you start any work on the product. Lock the main switch in position 0. Type and requirements as specified in EN 60204-1, 5.3.2.

WARNING

Electric shock



Death or serious personal injury

- Make sure that other pumps or sources do not force flow through the pump even if the pump is stopped.



If the power cable is damaged, it must be replaced by the manufacturer, the manufacturer's service partner or a similarly qualified person.

9.3 Reading out warning and alarm codes in Grundfos GO Remote

To read out alarm codes and text, connect the pump to Grundfos GO Remote and navigate to the "Alarms and warnings" menu. Grundfos Eye in the dashboard indicates the warning or alarm.

Step	Action	Illustration
1	<p>A. Select the "Alarms and warnings" menu from the dashboard,</p> <p>B. You can also reach the menu by tapping Grundfos Eye.</p>	

2	<p>The "Alarms and warnings" menu shows the current alarm code and text. A log history of previous alarms and warnings is also available.</p> <p>When the fault is corrected, reset the alarm by pressing the "Reset alarm" button.</p>	
---	---	--



When connecting Grundfos GO to one of the pumps of a twin-head pump, Grundfos GO reads out alarm codes and texts for that pump. If you want to see alarms and warnings for the other pump, connect to this instead.

An overview of warnings and alarms is also available in section [9.4 Fault finding table](#).

For instructions on how to connect the pump to Grundfos GO, see section [8.3 Connecting the pump to Grundfos GO Remote](#).

9.4 Fault finding table

Warning and alarm codes	Fault	Automatic reset and restart?	Corrective actions
"Pump communication fault" (10) Alarm	Communication fault between different parts of the electronics.	Yes	Replace the pump, or contact Grundfos Service. Check if the pump is running in turbine operation. See code (29) "Forced pumping".
"Forced pumping" (29) Alarm	Other pumps or sources force flow through the pump even if the pump is stopped and switched off.	Yes	Switch off the pump on the main switch. If the light in Grundfos Eye is on, the pump is running in forced-pumping mode. Check the system for defective non-return valves and replace the valves, if necessary. Check the system for correct position of non-return valves.
"Undervoltage" (40, 75) Alarm	The supply voltage to the pump is too low.	Yes	Make sure that the power supply is within the specified range.
"Blocked pump" (51) Alarm	The pump is blocked.	Yes	Dismantle the pump, and remove any foreign matter or impurities preventing the pump from rotating. Check the water quality to eliminate the risk of lime precipitation.
High motor temperature (64) Alarm	The temperature in the stator windings is too high.	No	Contact Grundfos Service, or replace the pump.
Internal fault (72 and 155) Alarm	Internal fault in the pump electronics. Irregularities in the voltage supply can cause alarm 72.	Yes	There might be turbine flow in the application that forces a flow through the pump. Contact Grundfos Service, or replace the pump.
"Overvoltage" (74) Alarm	The supply voltage to the pump is too high.	Yes	Make sure that the power supply is within the specified range.
Comm. fault, twin-head pump (77) Warning	The communication between pump heads was disturbed or broken.	-	Make sure that the second pump head is powered on or connected to the power supply.
Internal fault (84 and 85) Warning	Fault in the pump electronics.	-	Contact Grundfos Service, or replace the pump.

9.5 Warning 77, twin-head pump

A yellow Grundfos Eye in a twin-head pump system often means that the two heads have lost connection to each other, warning 77. This is often intermittent and caused by external disturbance, or because one of the heads has lost power.

The warning is shown immediately and triggers the fault relay after one hour. If communication is re-established, the warning is automatically reset.

9.5.1 Activating and deactivating the fault relay

It is possible to choose whether warning 77 should trigger the fault relay or not. This is done in Grundfos GO. For instructions on how to connect the pump to Grundfos GO, see section [8.3 Connecting the pump to Grundfos GO Remote](#).

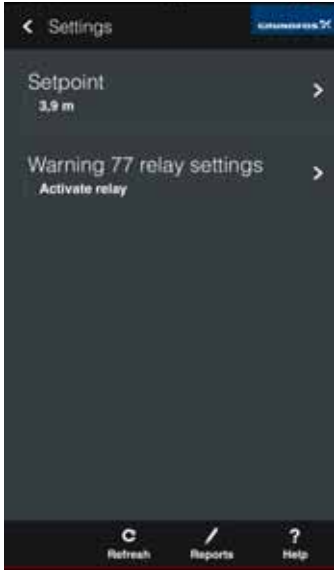
Step	Action	Illustration
1	Choose "Settings" in the Grundfos GO Remote dashboard.	 <p>The screenshot shows the 'Dashboard' screen with a menu on the left containing 'Status', 'Settings', and 'Alarms and warnings'. The 'Settings' option is highlighted.</p>
2	Choose "Warning 77 relay settings".	 <p>The screenshot shows the 'Settings' screen with 'Warning 77 relay settings' selected. Below it, the option 'Activate relay' is visible.</p>

TM06 8584 0817

TM06 8583 0817

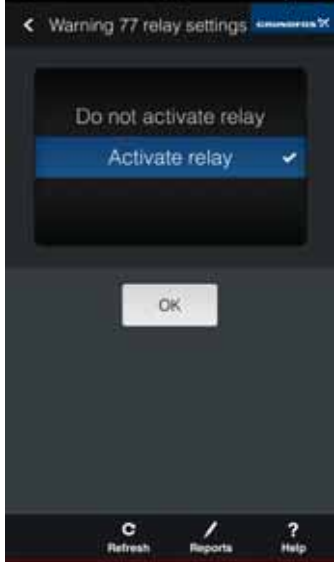
Step	Action	Illustration
3	By default the fault relay setting is activated. To disable the setting, choose "Do not activate relay". Press "OK".	 <p>The screenshot shows a dialog box with two options: 'Do not activate relay' and 'Activate relay'. The 'Activate relay' option is selected with a checkmark. An 'OK' button is at the bottom.</p>

MAGNA1_warning77

10. Technical data

Supply voltage

1 x 230 V ± 10 %, 50/60 Hz, PE.

Motor protection

The pump requires no external motor protection.

Enclosure class

IPX4D (EN 60529).

Insulation class

F.

Relative humidity

Maximum 95 %.

Ambient temperature

0 to 40 °C.

During transport: -40 to +70 °C.

Temperature class

TF110 (EN 60335-2-51).

Liquid temperature

Continuously: -10 to +110 °C.

Stainless steel pumps in domestic hot-water systems:

In domestic hot-water systems, we recommend that you keep the liquid temperature below 65 °C to eliminate the risk of lime precipitation.

Maximum system pressure



The actual inlet pressure and the pump pressure against a closed valve must be lower than the maximum permissible system pressure.

The maximum permissible system pressure is stated on the pump nameplate:

PN 6: 6 bar or 0.6 MPa

PN 10: 10 bar or 1.0 MPa

PN 16: 16 bar or 1.6 MPa.

Test pressure

The pumps can withstand test pressures as indicated in EN 60335-2-51.

- PN 6: 7.2 bar
- PN 10: 12 bar
- PN 6/10: 12 bar
- PN 16: 19.2 bar.

During normal operation, do not use the pump at higher pressures than those stated on the nameplate. See fig. 20.

The pressure test has been made with water containing anti-corrosive additives at a temperature of 20 °C.

Minimum inlet pressure

The following relative minimum inlet pressure must be available at the pump inlet during operation to avoid cavitation noise and damage to the pump bearings.



The values in the table below apply to single-head pumps and twin-head pumps in single-head operation.

Single-head pumps DN	Liquid temperature		
	75 °C	95 °C	110 °C
	Inlet pressure [bar] / [MPa]		
25-40/60/80/100/120	0.10 / 0.01	0.35 / 0.035	1.0 / 0.10
32-40/60/80/100/120	0.10 / 0.01	0.35 / 0.035	1.0 / 0.10
32-40/60/80/100/120 F	0.10 / 0.01	0.35 / 0.035	1.0 / 0.10
32-120 F	0.10 / 0.01	0.20 / 0.020	0.7 / 0.07
40-40/60 F	0.10 / 0.01	0.35 / 0.035	1.0 / 0.10
40-80/100/120/150/180 F	0.10 / 0.01	0.50 / 0.05	1.0 / 0.10
50-60/80 F	0.10 / 0.01	0.40 / 0.04	1.0 / 0.10
50-100/120 F	0.10 / 0.01	0.50 / 0.05	1.0 / 0.10
50-150/180 F	0.70 / 0.07	1.20 / 0.12	1.7 / 0.17
65-40/60/80/100/120/150 F	0.70 / 0.07	1.20 / 0.12	1.7 / 0.17
80-60/80/100/120 F	0.50 / 0.05	1.00 / 0.10	1.5 / 0.15
100-40/60/80/100/120 F	0.70 / 0.07	1.20 / 0.12	1.7 / 0.17

In the case of twin-head operation, increase the required relative inlet pressure by 0.1 bar or 0.01 MPa compared to the stated values for single-head pumps or twin-head pumps in single-head operation.

The relative minimum inlet pressures apply to pumps installed up to 300 metres above sea level. For altitudes above 300 metres, increase the required relative inlet pressure by 0.01 bar or 0.001 MPa per 100 metres altitude. The pump is only approved for an altitude of maximum 2000 metres above sea level.

Sound pressure level

The sound pressure level of the pump is dependent on the power consumption. Levels are determined in accordance with ISO 3745 and ISO 11203, method Q2.

Pump size	Max. dB(A)
25-40/60/80/100/120	39
32-40/60/80/100/120	
40-40/60	
50-40	
32-120 F	45
40-80/100	
50-60/80	
65-40/60	
80-40	
40-120/150/180	50
50-100/120/150/180	
65-80/100/120	
80-60/80	
100-40/60	
65-150	55
80-100/120	
100-80/100/120	

Leakage current

The mains filter will cause a leakage current to earth during operation. The leakage current is less than 3.5 mA.

Power factor

The terminal-connected versions have a built-in active power-factor correction which gives a $\cos \varphi$ from 0.98 to 0.99. The plug-connected versions have a built-in passive power-factor correction with coil and resistors which ensure that the current drawn from the grid is in phase with the voltage and that the current is approximately sinusoidal which gives a $\cos \varphi$ from 0.55 to 0.98.

Input and output communication

Digital input	External potential-free contact. Contact load: 5 V, 10 mA. Screened cable. Loop resistance: Maximum 130 Ω .
Relay output	Internal potential-free changeover contact. Maximum load: 250 V, 2 A, AC1. Minimum load: 5 VCD, 20 mA. Screened cable, depending on signal level.

11. Disposing of the product

This product has been designed with focus on the disposal and recycling of materials. The following average disposal values apply to all variants of MAGNA1 pumps:

- 85 % recycling
- 10 % incineration
- 5 % depositing.

This product or parts of it must be disposed of in an environmentally sound way:

1. Use the public or private waste collection service.
2. If this is not possible, contact the nearest Grundfos company or service workshop.



The crossed-out wheellie bin symbol on a product means that it must be disposed of separately from household waste. When a product marked with this symbol reaches its end of life, take it to a collection point designated by the local waste disposal authorities. The separate collection and recycling of such products will help protect the environment and human health.

See also end-of-life information at www.grundfos.com/product-recycling.

WARNING

Magnetic field



Death or serious personal injury

- Persons with pacemakers disassembling this product must exercise care when handling the magnetic materials embedded in the rotor.

1. Dimensions, threaded versions

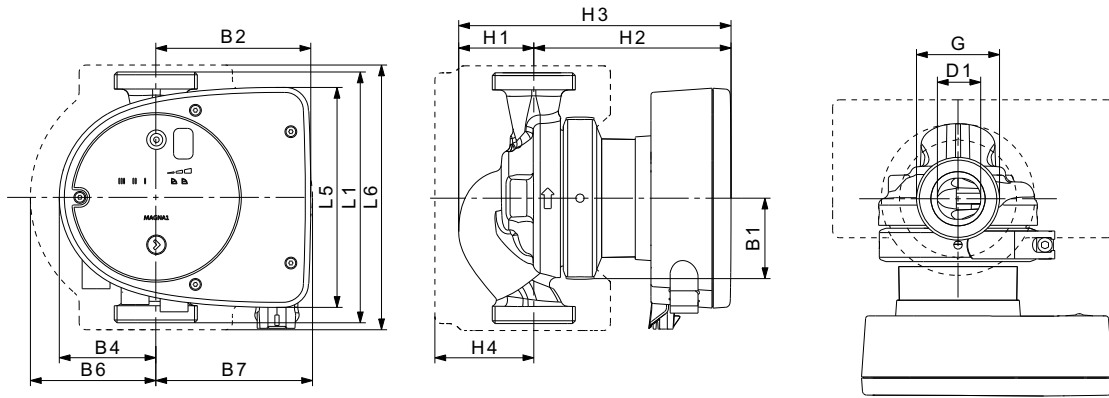

Fig. 1 Single-head pump dimensions, threaded version

TM06 9948 3717

Pump type	Dimensions [mm]												[inch]	
	L1	L5	L6	B1	B2	B4	B6	B7	H1	H2	H3	H4	D1	G
MAGNA1 25-40 (N)	180	158	190	58	111	69	90	113	54	142	196	71	25	1 1/2
MAGNA1 25-60 (N)	180	158	190	58	111	69	90	113	54	142	196	71	25	1 1/2
MAGNA1 25-80 (N)	180	158	190	58	111	69	90	113	54	142	196	71	25	1 1/2
MAGNA1 25-100 (N)	180	158	190	58	111	69	90	113	54	142	196	71	25	1 1/2
MAGNA1 25-120 (N)	180	158	190	58	111	69	90	113	54	142	196	71	25	1 1/2
MAGNA1 32-40 (N)	180	158	190	58	111	69	90	113	54	142	196	71	32	2
MAGNA1 32-60 (N)	180	158	190	58	111	69	90	113	54	142	196	71	32	2
MAGNA1 32-80 (N)	180	158	190	58	111	69	90	113	54	142	196	71	32	2
MAGNA1 32-100 (N)	180	158	190	58	111	69	90	113	54	142	196	71	32	2
MAGNA1 32-120 (N)	180	158	190	58	111	69	90	113	54	142	196	71	32	2

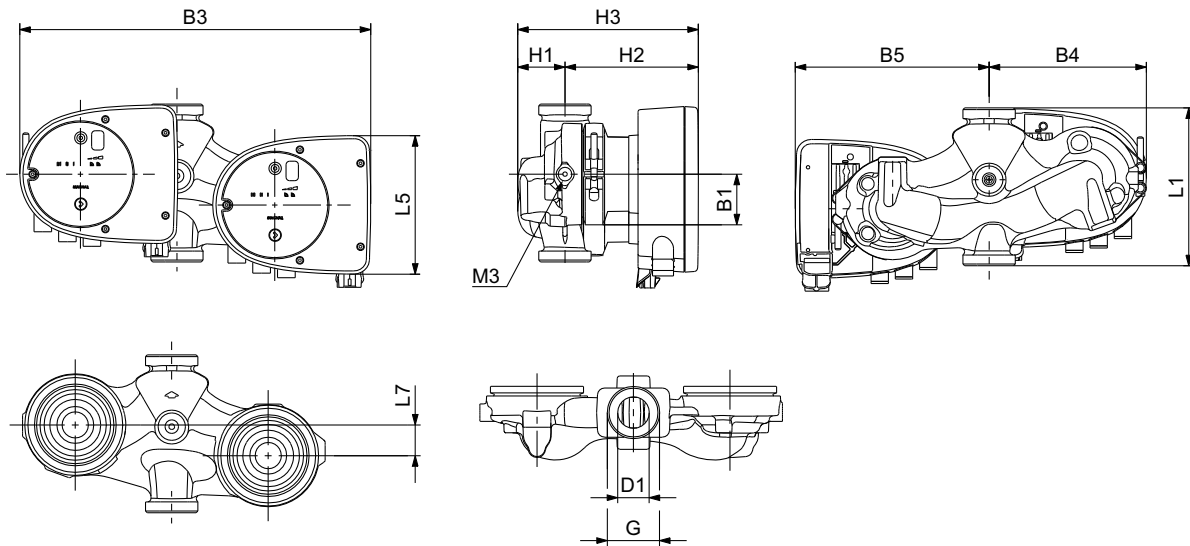

Fig. 2 Twin-head pump dimensions, threaded version

TM07 0068 4117

2. Dimensions, flanged versions

Pump type	Dimensions [mm]											[inch]	
	L1	L5	L7	B1	B3	B4	B5	H1	H2	H3	D1	G	M3
MAGNA1 D 32-40	180	158	35	58	400	179	221	54	142	196	32	2	1/4
MAGNA1 D 32-60	180	158	35	58	400	179	221	54	142	196	32	2	1/4
MAGNA1 D 32-80	180	158	35	58	400	179	221	54	142	196	32	2	1/4
MAGNA1 D 32-100	180	158	35	58	400	179	221	54	142	196	32	2	1/4

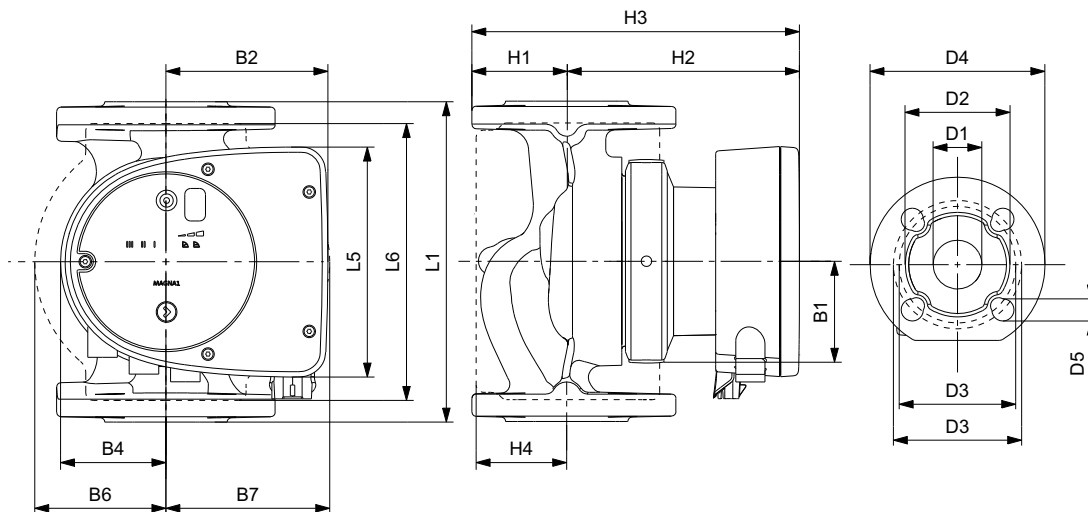

Fig. 3 Single-head pump dimensions, plug-connected versions, flanged version

TM07 0067 4117

Pump type	Dimensions [mm]																
	L1	L5	L6	B1	B2	B4	B6	B7	H1	H2	H3	H4	D1	D2	D3	D4	D5
MAGNA1 32-40 F (N)	220	158	220	58	111	69	100	110	65	142	207	82	32	76	90/100	140	14/19
MAGNA1 32-60 F (N)	220	158	220	58	111	69	100	110	65	142	207	82	32	76	90/100	140	14/19
MAGNA1 32-80 F (N)	220	158	220	58	111	69	100	110	65	142	207	82	32	76	90/100	140	14/19
MAGNA1 32-100 F (N)	220	158	220	58	111	69	100	110	65	142	207	82	32	76	90/100	140	14/19
MAGNA1 40-40 F (N)	220	158	220	58	111	69	105	105	65	156	221	83	40	84	100/110	150	14/19
MAGNA1 40-60 F (N)	220	158	220	58	111	69	105	105	65	156	221	83	40	84	100/110	150	14/19

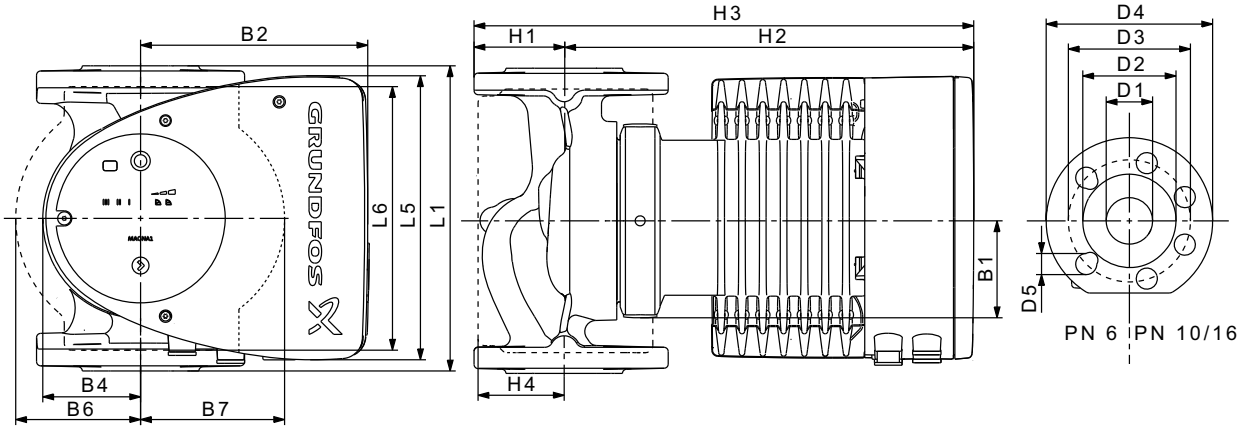

Fig. 4 Single-head pump dimensions, terminal-connected versions, flanged version

TM05 5276 3512

Pump type	Dimensions [mm]																
	L1	L5	L6	B1	B2	B4	B6	B7	H1	H2	H3	H4	D1	D2	D3	D4	D5
MAGNA1 32-120 F (N)	220	204	216	84	164	73	106	116	65	301	366	86	32	76	90/100	140	14/19
MAGNA1 40-80 F (N)	220	204	220	84	164	73	106	128	65	304	369	83	40	84	100/110	150	14/19
MAGNA1 40-100 F (N)	220	204	220	84	164	73	106	128	65	304	369	83	40	84	100/110	150	14/19
MAGNA1 40-120 F (N)	250	204	220	84	164	73	106	128	65	304	369	83	40	84	100/110	150	14/19
MAGNA1 40-150 F (N)	250	204	220	84	164	73	106	128	65	304	369	83	40	84	100/110	150	14/19
MAGNA1 40-180 F (N)	250	204	220	84	164	73	106	128	65	304	369	83	40	84	100/110	150	14/19
MAGNA1 50-60 F (N)	240	204	240	84	164	73	127	127	71	304	374	97	50	102	110/125	165	14/19
MAGNA1 50-80 F (N)	240	204	240	84	164	73	127	127	71	304	374	97	50	102	110/125	165	14/19
MAGNA1 50-100 F (N)	280	204	240	84	164	73	127	127	72	304	376	97	50	102	110/125	165	14/19
MAGNA1 50-120 F (N)	280	204	240	84	164	73	127	127	72	304	376	97	50	102	110/125	165	14/19
MAGNA1 50-150 F (N)	280	204	240	84	164	73	127	127	72	304	376	97	50	102	110/125	165	14/19
MAGNA1 50-180 F (N)	280	204	240	84	164	73	127	127	72	304	376	97	50	102	110/125	165	14/19
MAGNA1 65-40 F (N)	340	204	296	84	164	73	133	133	74	312	386	94	65	119	130/145	185	14/19
MAGNA1 65-60 F (N)	340	204	296	84	164	73	133	133	74	312	386	94	65	119	130/145	185	14/19
MAGNA1 65-80 F (N)	340	204	296	84	164	73	133	133	74	312	386	94	65	119	130/145	185	14/19
MAGNA1 65-100 F (N)	340	204	296	84	164	73	133	133	74	312	386	94	65	119	130/145	185	14/19
MAGNA1 65-120 F (N)	340	204	296	84	164	73	133	133	74	312	386	94	65	119	130/145	185	14/19
MAGNA1 65-150 F (N)	340	204	296	84	164	73	133	133	74	312	386	94	65	119	130/145	185	14/19
MAGNA1 80-60 F	360	204	310	84	164	73	163	163	96	318	413	115	80	128	150/160	200	19
MAGNA1 80-80 F	360	204	310	84	164	73	163	163	96	318	413	115	80	128	150/160	200	19
MAGNA1 80-100 F	360	204	310	84	164	73	163	163	96	318	413	115	80	128	150/160	200	19
MAGNA1 80-120 F	360	204	310	84	164	73	163	163	96	318	413	115	80	128	150/160	200	19
MAGNA1 100-40 F	450	204	396	84	164	73	178	178	103	330	433	120	100	160	170	220	19
MAGNA1 100-60 F	450	204	396	84	164	73	178	178	103	330	433	120	100	160	170	220	19
MAGNA1 100-80 F	450	204	396	84	164	73	178	178	103	330	433	120	100	160	170	220	19
MAGNA1 100-100 F	450	204	396	84	164	73	178	178	103	330	433	120	100	160	170	220	19
MAGNA1 100-120 F	450	204	396	84	164	73	178	178	103	330	433	120	100	160	170	220	19

TM07 0069 4117

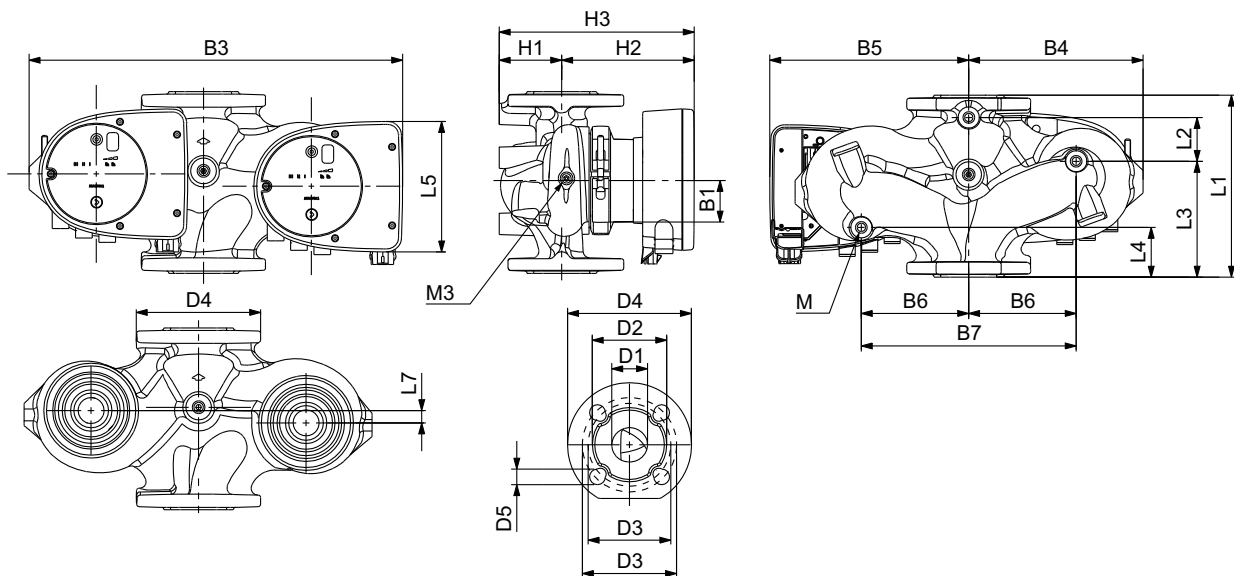

Fig. 5 Twin-head pump dimensions, plug-connected versions, flanged version

Pump type	Dimensions [mm]																				
	L1	L2	L3	L4	L5	L7	B1	B3	B4	B5	B6	B7	H1	H2	H3	D1	D2	D3	D4	D5	M
MAGNA1 D 32-40 F	220	73	120	85	158	35	58	400	179	221	130	260	69	142	211	32	76	90/100	140	14/19	12
MAGNA1 D 32-60 F	220	73	120	85	158	35	58	400	179	221	130	260	69	142	211	32	76	90/100	140	14/19	12
MAGNA1 D 32-80 F	220	73	120	85	158	35	58	400	179	221	130	260	69	142	211	32	76	90/100	140	14/19	12
MAGNA1 D 40-40 F	220	53	140	60	158	15	58	452	211	241	130	260	76	156	232	40	84	100/110	150	14/19	12
MAGNA1 D 40-60 F	220	53	140	60	158	15	58	452	211	241	130	260	76	156	232	40	84	100/110	150	14/19	12
MAGNA1 D 40-80 F	220	53	140	60	204	15	84	502	210	294	130	260	76	303	379	40	84	100/110	150	14/19	12

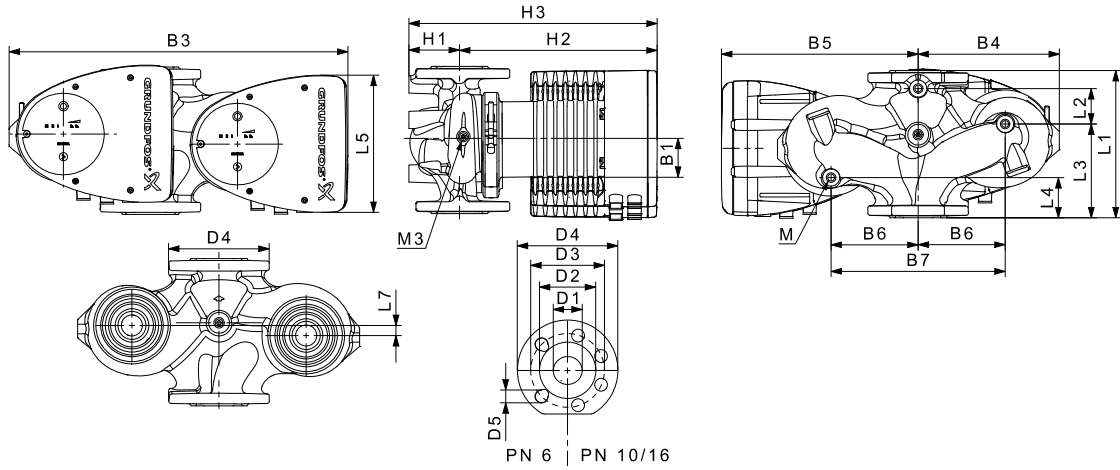

Fig. 6 Twin-head pump dimensions, terminal-connected versions, flanged version

TM05 5275 3512

Pump type	Dimensions [mm]																				
	L1	L2	L3	L4	L5	L7	B1	B3	B4	B5	B6	B7	H1	H2	H3	D1	D2	D3	D4	D5	M
MAGNA1 D 32-120 F	220	97	90	50	204	50	84	502	210	294	130	260	68	300	368	32	76	90/100	140	14/19	12
MAGNA1 D 40-80 F	220	53	140	60	204	15	84	502	210	294	130	260	76	303	379	40	84	100/110	150	14/19	12
MAGNA1 D 40-100 F	220	53	140	60	204	15	84	502	210	294	130	260	76	303	379	40	84	100/110	150	14/19	12
MAGNA1 D 40-120 F	250	58	155	75	204	0	84	512	220	294	130	260	69	303	372	40	84	100/110	150	14/19	12
MAGNA1 D 40-150 F	250	58	155	75	204	0	84	512	220	294	130	260	69	303	372	40	84	100/110	150	14/19	12
MAGNA1 D 40-180 F	250	58	155	75	204	0	84	512	220	294	130	260	69	303	372	40	84	100/110	150	14/19	12
MAGNA1 D 50-40 F	240	48	160	45	204	45	84	515	221	294	130	260	75	304	379	50	102	110/125	165	14/19	12
MAGNA1 D 50-60 F	240	48	160	45	204	45	84	515	221	294	130	260	75	304	379	50	102	110/125	165	14/19	12
MAGNA1 D 50-80 F	240	48	160	45	204	45	84	515	221	294	130	260	75	304	379	50	102	110/125	165	14/19	12
MAGNA1 D 50-100 F	280	175	75	75	204	0	84	517	223	294	130	260	75	304	379	50	102	110/125	165	14/19	12
MAGNA1 D 50-120 F	280	175	75	75	204	0	84	517	223	294	130	260	75	304	379	50	102	110/125	165	14/19	12
MAGNA1 D 50-150 F	280	175	75	75	204	0	84	517	223	294	130	260	75	304	379	50	102	110/125	165	14/19	12
MAGNA1 D 50-180 F	280	175	75	75	204	0	84	517	223	294	130	260	75	304	379	50	102	110/125	165	14/19	12
MAGNA1 D 65-40 F	340	218	92	92	204	0	84	522	228	294	130	260	77	312	389	65	119	130/145	185	14/19	12
MAGNA1 D 65-60 F	340	218	92	92	204	0	84	522	228	294	130	260	77	312	389	65	119	130/145	185	14/19	12
MAGNA1 D 65-80 F	340	218	92	92	204	0	84	522	228	294	130	260	77	312	389	65	119	130/145	185	14/19	12
MAGNA1 D 65-100 F	340	218	92	92	204	0	84	522	228	294	130	260	77	312	389	65	119	130/145	185	14/19	12
MAGNA1 D 65-120 F	340	218	92	92	204	0	84	522	228	294	130	260	77	312	389	65	119	130/145	185	14/19	12
MAGNA1 D 65-150 F	340	218	92	92	204	0	84	522	228	294	130	260	77	312	389	65	119	130/145	185	14/19	12
MAGNA1 D 80-40 F	360	218	102	102	204	0	84	538	244	294	130	260	97	318	415	80	128	150/160	200	19	12
MAGNA1 D 80-60 F	360	218	102	102	204	0	84	538	244	294	130	260	97	318	415	80	128	150/160	200	19	12
MAGNA1 D 80-80 F	360	218	102	102	204	0	84	538	244	294	130	260	97	318	415	80	128	150/160	200	19	12

Pump type	Dimensions [mm]																				
	L1	L2	L3	L4	L5	L7	B1	B3	B4	B5	B6	B7	H1	H2	H3	D1	D2	D3	D4	D5	M
MAGNA1 D 80-100 F	360	218	102	102	204	0	84	538	244	294	130	260	97	318	415	80	128	150/160	200	19	12
MAGNA1 D 80-120 F	360	218	102	102	204	0	84	538	244	294	130	260	97	318	415	80	128	150/160	200	19	12
MAGNA1 D 100-40 F	450	243	147	147	204	0	84	551	252	299	135	270	103	330	434	100	160	170	220	19	12
MAGNA1 D 100-60 F	450	243	147	147	204	0	84	551	252	299	135	270	103	330	434	100	160	170	220	19	12
MAGNA1 D 100-80 F	450	243	147	147	204	0	84	551	252	299	135	270	103	330	434	100	160	170	220	19	12
MAGNA1 D 100-100 F	450	243	147	147	204	0	84	551	252	299	135	270	103	330	434	100	160	170	220	19	12
MAGNA1 D 100-120 F	450	243	147	147	204	0	84	551	252	299	135	270	103	330	434	100	160	170	220	19	12



M3: Rp 1/4 for a vent valve is available on all twin-head pumps.

3. Forces and moments

Maximum permissible forces and moments from the pipe connections acting on the pump flanges are indicated in fig 7.

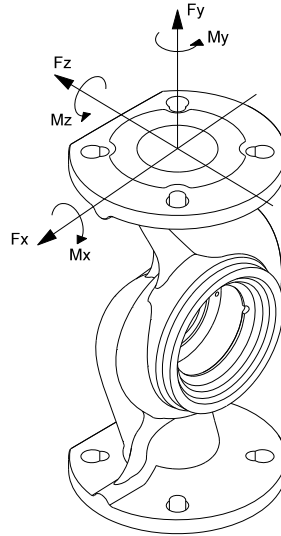

Fig. 7 Forces and moments from the pipe connections acting on the pump flanges

Diameter DN	Force [N]			Moment [Nm]				
	Fy	Fz	Fx	ΣF_b	My	Mz	Mx	ΣM_b
25*	350	425	375	650	300	350	450	650
32*	425	525	450	825	375	425	550	800
40	500	625	550	975	450	525	650	950
50	675	825	750	1300	500	575	700	1025
65	850	1050	925	1650	550	600	750	1100
80	1025	1250	1125	1975	575	650	800	1175
100	1350	1675	1500	2625	625	725	875	1300

* The values also apply to pumps with threaded connection.

The above values apply to cast-iron versions. For stainless-steel versions, the values can be multiplied by two according to the ISO 5199 standard.

4. Tightening torques for bolts

Recommended tightening torques for bolts used in flanged connections:

Bolt dimension	Torque
M12	27 Nm
M16	66 Nm

99209952 0719

ECM: 1265030
