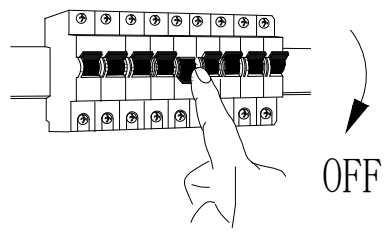
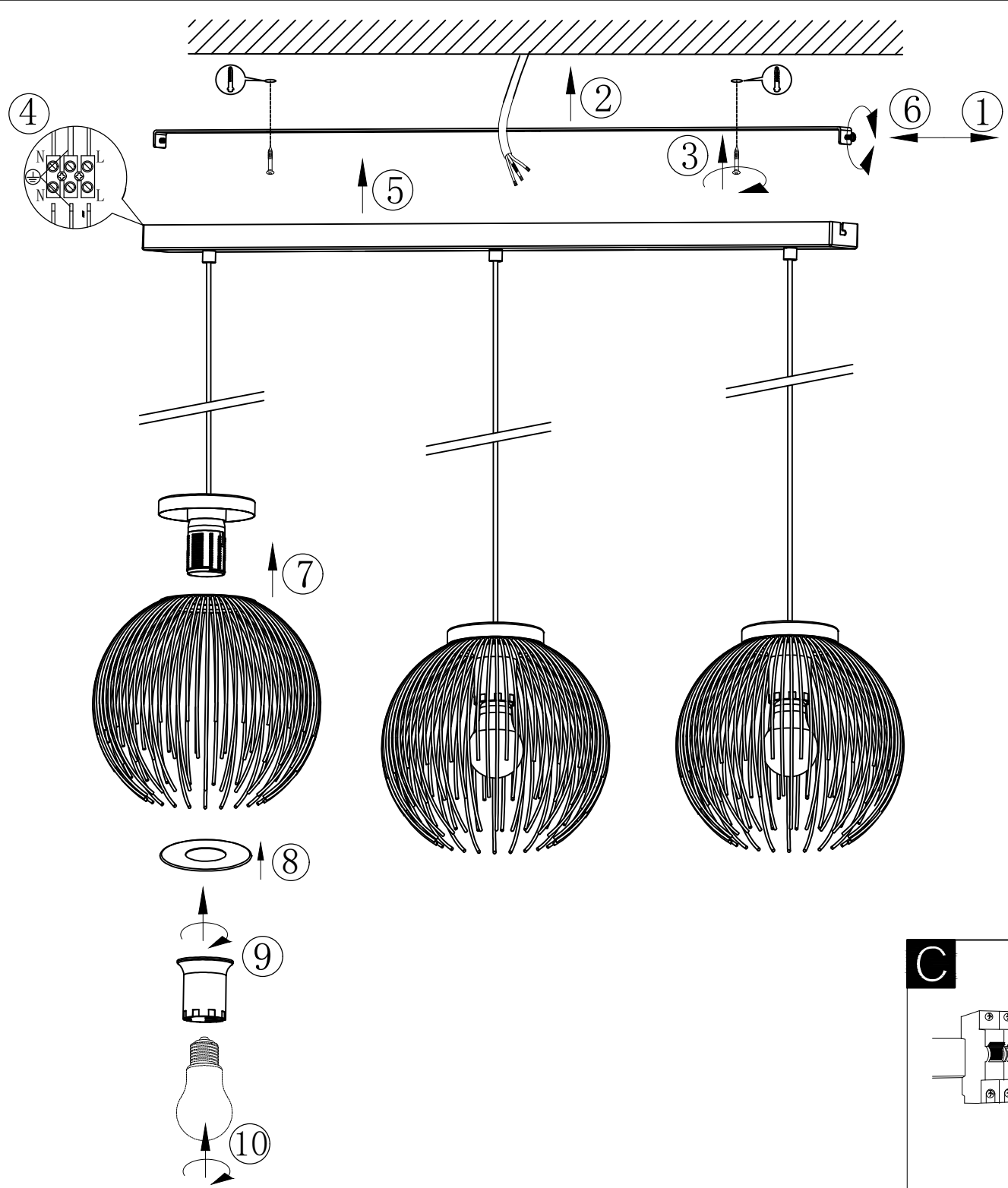
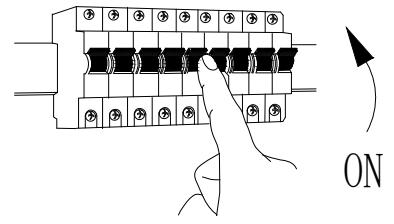

**A****B****C**

BLA900167  
[www.eglo.com](http://www.eglo.com)