

## P/N: 63907-0804

### Copyright

© 2022, FLIR Systems, Inc.

All rights reserved worldwide. Names and marks appearing herein are either registered trademarks or trademarks of FLIR Systems and/or its subsidiaries. All other trademarks, trade names or company names referenced herein are used for identification only and are the property of their respective owners.

### Document identity

Publ. No.: 63907-0804

Commit: 84749

Language:

Modified: 2022-05-02

Formatted: 2022-05-02

### Website

<http://www.flir.com>

### Customer support

<http://support.flir.com>

### Disclaimer

Specifications subject to change without further notice. Camera models and accessories subject to regional market considerations. License procedures may apply. Products described herein may be subject to US Export Regulations. Please refer to [exportquestions@flir.com](mailto:exportquestions@flir.com) with any questions.



### General description

The FLIR Ex series cameras are point-and-shoot infrared cameras that give you access to the infrared world. A FLIR Ex series camera is an affordable replacement for an infrared thermometer, providing a thermal image with temperature information in every pixel. The new MSX and visual formats make the cameras incomparably easy to use.

The FLIR Ex series cameras are user-friendly, compact, and rugged, for use in harsh environments. The wide field of view makes them the perfect choice for building applications.

#### Benefits:

- Easy to use: The FLIR Ex series cameras are fully automatic and focus-free with an intuitive interface for simple measurements in thermal, visual, or MSX mode.
- Compact and rugged: The FLIR Ex series cameras' low weight of 0.575 kg and the accessory belt pouch make them easy to bring along at all times. Their rugged design can withstand a 2 m drop test, and ensures reliability, even in harsh environments.
- Ground breaking affordability: The FLIR Ex series cameras are the most affordable infrared cameras on the market.

### Imaging and optical data

IR resolution	240 × 180 pixels
Thermal sensitivity/NETD	< 0.06°C (0.11°F) / < 60 mK
Field of view (FOV)	45° × 34°
Minimum focus distance	0.5 m (1.6 ft.)
Spatial resolution (IFOV)	3.4 mrad
F-number	1.5
Image frequency	9 Hz
Focus	Focus free

### Detector data

Detector type	Focal plane array (FPA), uncooled microbolometer
Spectral range	7.5–13 μm

### Image presentation

Display	3.0 in. 320 × 240 color LCD
Image adjustment	Automatic/Manual



## FLIR E6xt (incl. Wi-Fi)

P/N: 63907-0804

© 2022, FLIR Systems, Inc.

#63907-0804; r. 84749;

<b>Image presentation modes</b>	
Image modes	Thermal MSX, Thermal, Picture-in-Picture, Thermal blending, Digital camera.
Multi Spectral Dynamic Imaging (MSX)	IR image with enhanced detail presentation
Picture in Picture	IR area on visual image
<b>Measurement</b>	
Camera temperature range	<ul style="list-style-type: none"><li>-20 to 250°C (-4 to 482°F)</li><li>10 to 550°C (50 to 1022°F)</li></ul>
Object temperature range and accuracy (for ambient temp. 10 to 35°C (50 to 95°F) and object temp. above 0°C (32°F))	<ul style="list-style-type: none"><li>Range -20 to 250°C (-4 to 482°F):<ul style="list-style-type: none"><li>0 to 100°C (32 to 212°F): ±2°C (±3.6°F)</li><li>100 to 250°C (212 to 482°F): ±2%</li></ul></li><li>Range 10 to 550°C (50 to 1022°F):<ul style="list-style-type: none"><li>10 to 100°C (50 to 212°F): ±3°C (±5.4°F)</li><li>100 to 550°C (212 to 1022°F): ±3%</li></ul></li></ul>
<b>Measurement analysis</b>	
Spotmeter	Center spot
Area	Box with max./min.
Isotherm	Above alarm, Below alarm
Emissivity correction	Variable from 0.1 to 1.0
Emissivity table	Emissivity table of predefined materials
Reflected apparent temperature correction	Automatic, based on input of reflected temperature
<b>Set-up</b>	
Color palettes	Black and white, iron and rainbow
Set-up commands	Local adaptation of units, language, date and time formats
<b>Storage of images</b>	
File formats	Standard JPEG, 14-bit measurement data included
<b>Digital camera</b>	
Digital camera, resolution	640 × 480
Digital camera, FOV	55° × 43°
<b>Data communication interfaces</b>	
Interfaces	USB Micro: Data transfer to and from PC and Mac device
Wi-Fi	Peer-to-peer (ad hoc) or infrastructure (network)
<b>Radio</b>	
Wi-Fi	<ul style="list-style-type: none"><li>Standard: 802.11 b/g/n</li><li>Frequency range:<ul style="list-style-type: none"><li>2400–2480 MHz</li><li>5150–5260 MHz</li></ul></li><li>Max. output power: 15 dBm</li></ul>
<b>Power system</b>	
Battery type	Rechargeable Li ion battery
Battery voltage	3.6 V



## FLIR E6xt (incl. Wi-Fi)

P/N: 63907-0804

© 2022, FLIR Systems, Inc.

#63907-0804; r. 84749;

Power system	
Battery operating time	Approx. 4 hours at +25°C (+77°F) ambient temperature and typical use
Charging system	Battery is charged inside the camera or in specific charger.
Charging time	2.5 hours to 90% capacity in camera. 2 hours in charger.
Power management	Automatic shut-down
AC operation	AC adapter, 90–260 VAC input, 5 VDC output to camera
Battery documents	For documents like MSDS and UN38.3 test reports/summaries, see: <a href="https://support.flir.com/resources/msds">https://support.flir.com/resources/msds</a>

Environmental data	
Operating temperature range	–15°C to +50°C (+5°F to +122°F)
Storage temperature range	–40°C to +70°C (–40°F to +158°F)
Humidity (operating and storage)	IEC 60068-2-30/24 h 95% relative humidity
EMC	<ul style="list-style-type: none"><li>• EN 61000-6-2 (Immunity)</li><li>• EN 61000-6-3 (Emission)</li><li>• FCC 47 CFR Part 15 Class B (Emission)</li><li>• RCM</li></ul>
Radio spectrum	<ul style="list-style-type: none"><li>• ETSI EN 300 328</li><li>• ETSI EN 301 893</li><li>• FCC 47 CFR Part 15 C, E</li><li>• RSS-247 Issue 2</li></ul>
Hazardous substances	<ul style="list-style-type: none"><li>• WEEE 2012/19/EU</li><li>• RoHs 2011/65/EU</li></ul>
Encapsulation	IP 54 (IEC 60529)
Shock	25 g (IEC 60068-2-27)
Vibration	2 g (IEC 60068-2-6)
Drop	2 m (6.6 ft.)
Safety	Camera: <ul style="list-style-type: none"><li>• IEC/EN 60950-1, IEC/EN 62368-1</li></ul> Power supply: <ul style="list-style-type: none"><li>• IEC/EN 62368-1</li><li>• CSA/UL/KC/SAA/PSE 60950-1</li></ul>
Declaration of conformity	See: <a href="https://support.flir.com/resources/DoC">https://support.flir.com/resources/DoC</a>

Physical data	
Camera weight, incl. battery	0.575 kg (1.27 lb.)
Camera size (L × W × H)	244 × 95 × 140 mm (9.6 × 3.7 × 5.5 in.)
Color	Black and gray



## FLIR E6xt (incl. Wi-Fi)

P/N: 63907-0804

© 2022, FLIR Systems, Inc.

#63907-0804; r. 84749;

Shipping information	
Packaging, type	Cardboard box
List of contents	<ul style="list-style-type: none"><li>• Infrared camera</li><li>• Hard transport case</li><li>• Battery (inside camera)</li><li>• USB cable</li><li>• Power supply/charger with EU, UK, US and Australian plugs</li><li>• FLIR Thermal Studio Starter</li><li>• Printed documentation</li></ul>
Packaging, weight	2.9 kg (6.4 lb.)
Packaging, size	385 × 165 × 315 mm (15.2 × 6.5 × 12.4 in.)
EAN-13	4743254004016
UPC-12	845188018795
Country of origin	Estonia

### Supplies & accessories:

- T198528; Hard transport case FLIR Ex series
- T198531; Battery charger incl power supply
- T198532; Car charger
- T198534; Power supply USB-micro
- T198529; Pouch FLIR Ex and ix series
- T198533; USB cable Std A <-> Micro B
- T199362ACC; Battery Li-ion 3.6 V, 2.6 Ah, 9.4 Wh
- T911689ACC; Pouch for FLIR E-series
- T911093; Tool belt
- T300083; FLIR Thermal Studio Pro, Perpetual license
- T300341; FLIR Thermal Studio Standard, 1 Year Subscription
- T300258; FLIR Thermal Studio Standard, Perpetual license
- T199233; FLIR Atlas SDK for .NET

Camera with built-in IR lens f=6,5 mm (45°)

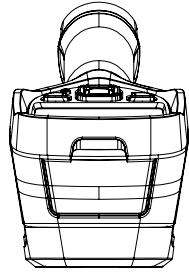
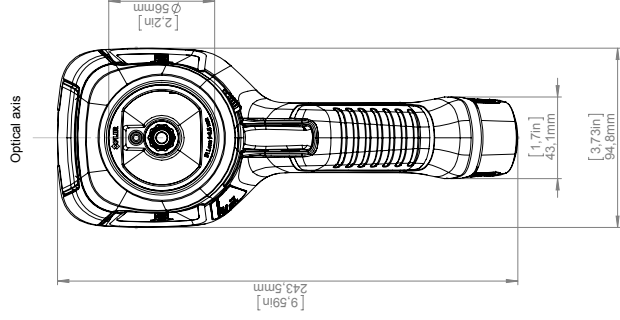
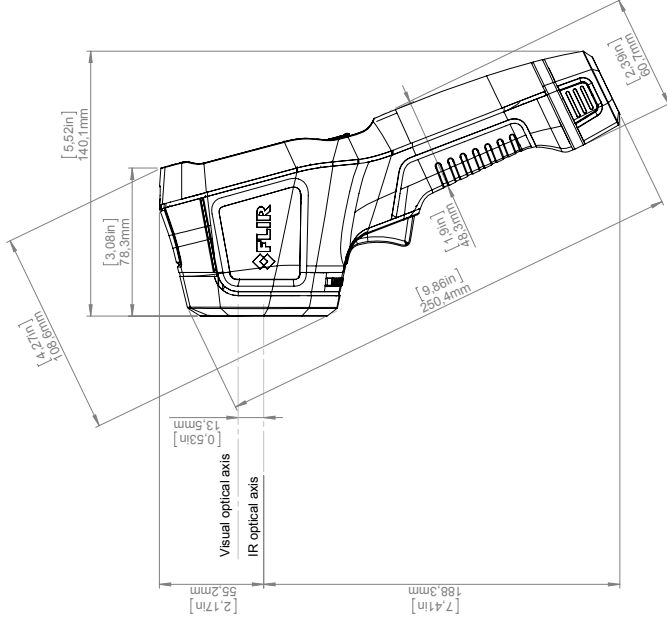
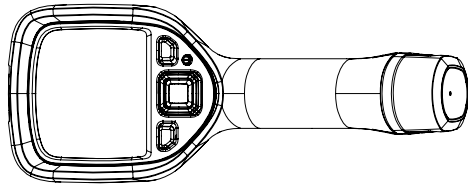
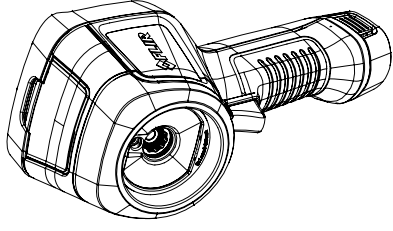
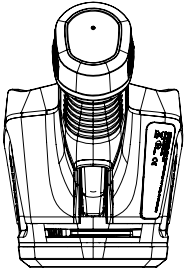

# Charger and Power pack

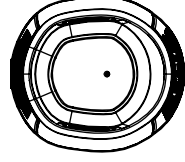
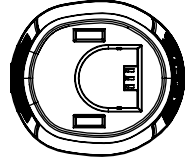
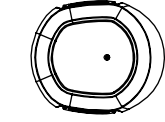
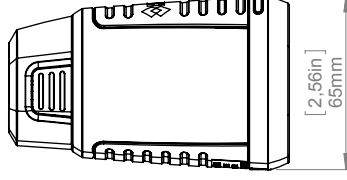
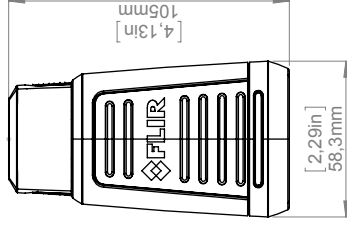
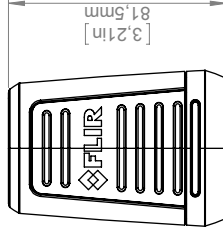
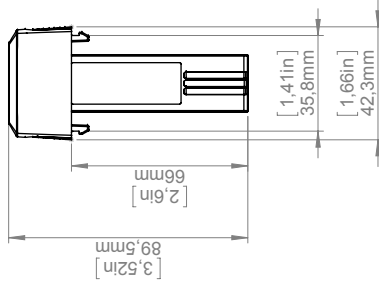
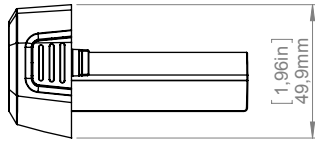
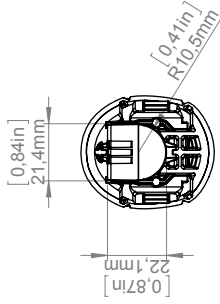
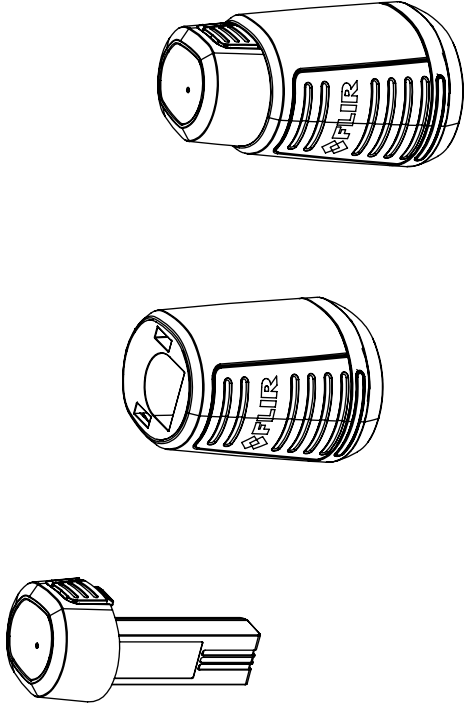

		Size: A3 Scale: 1:2 Drawing No: T127831 Sheet: 2(2)
Modified: 2013-03-25 Denomination:	Check: CAHA Drawn by: R&D Thermography	Basic dimensions FLIR Ex

© 2012, FLIR Systems, Inc. All rights reserved worldwide. No part of this drawing may be reproduced, stored in a retrieval system, or transmitted in any form, or by any means, electronic, mechanical, photocopying, recording, or otherwise, without written permission from FLIR Systems, Inc. Specifications subject to change without further notice. Dimensional data is based on nominal values. Products may be subject to regional market considerations. License procedures may apply. Product may be subject to US Export Regulations. Please refer to exportquestions@flir.com with any questions. Division contrary to US law is prohibited.