

612-1

09/21

Montageanleitung

(bitte zusammen mit Kaufbeleg aufbewahren)

Assembly instructions

(please retain and file together with the purchase receipt)

Notice de montage

(à conserver et à accrocher impérativement avec le justificatif d'achat)

Montagehandleiding

(samen met de aankoopfactuur in ieder geval bewaren)

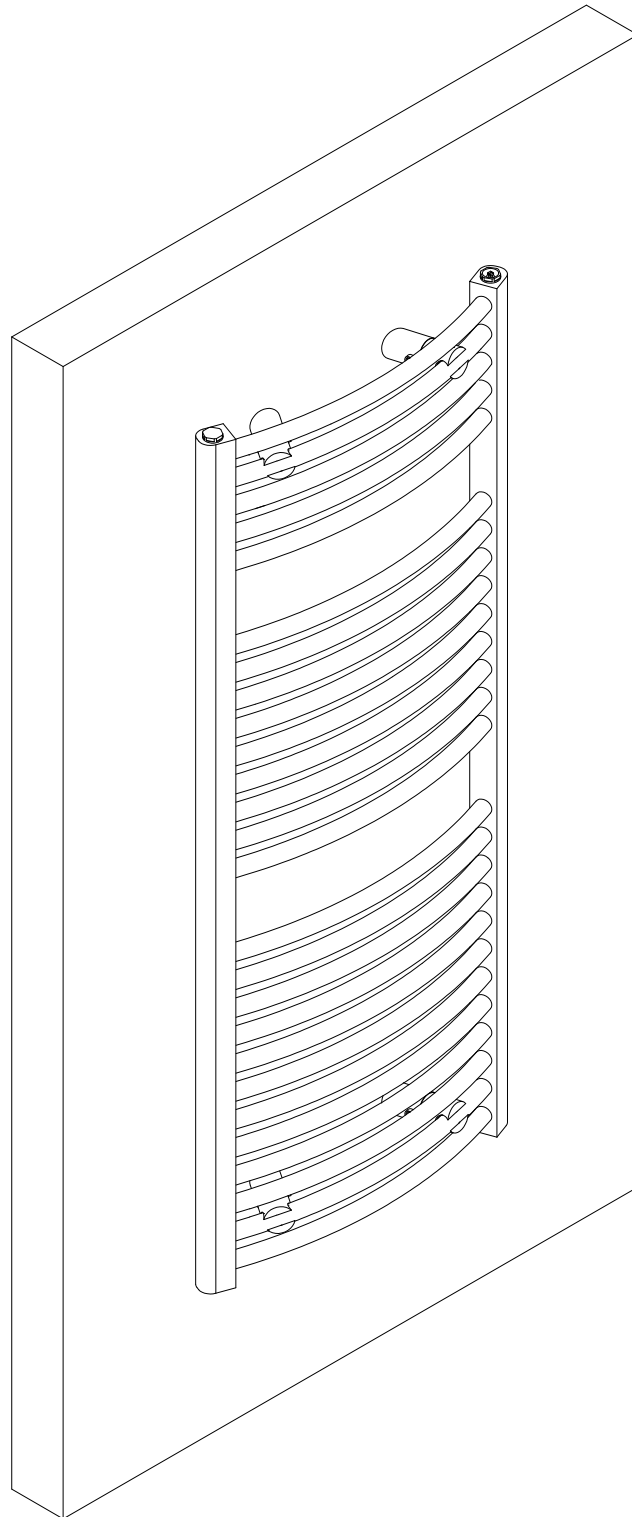

- Ⓓ Produktübersicht
- ⒼⒹ product overview
- Ⓕ aperçu produit
- ⒼⒶ productoverzicht

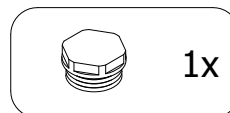
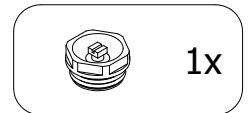
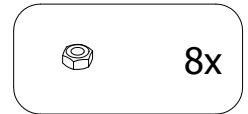
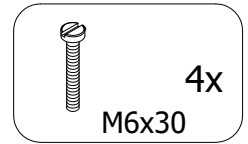
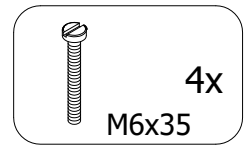
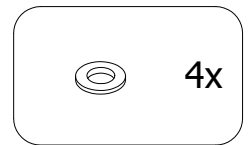
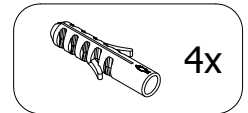
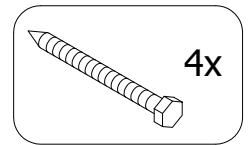
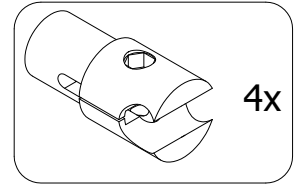
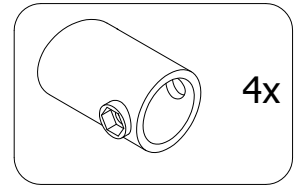
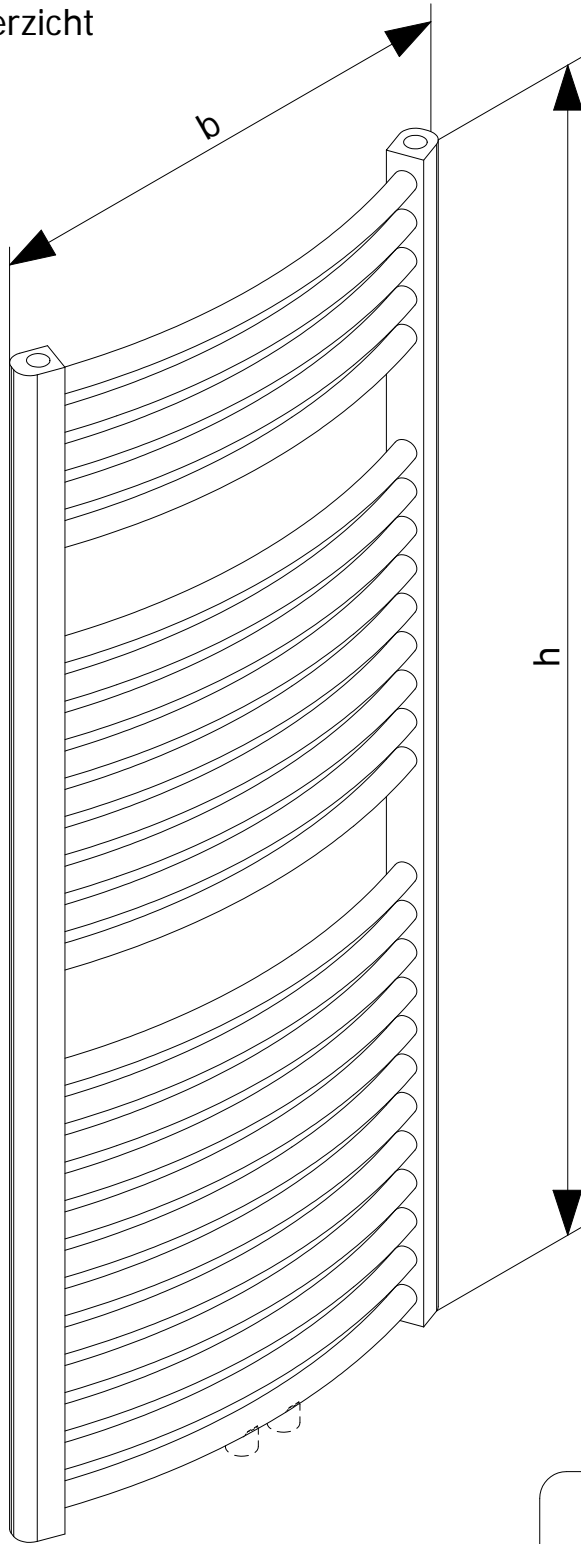

oder
or
ou
of

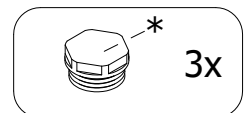

Benötigtes Werkzeug / Tool needed / outillage necessaire / Benodigd gereedschap

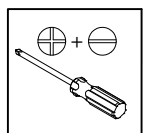
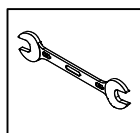
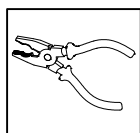
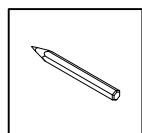
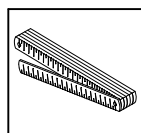
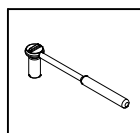
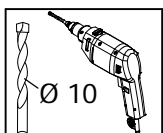
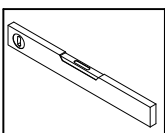

- Ⓚ Heizkörperdimensionen
- Ⓒ Radiator dimensions
- Ⓕ Dimensions du radiateur
- Ⓝ Radiatorafmetingen

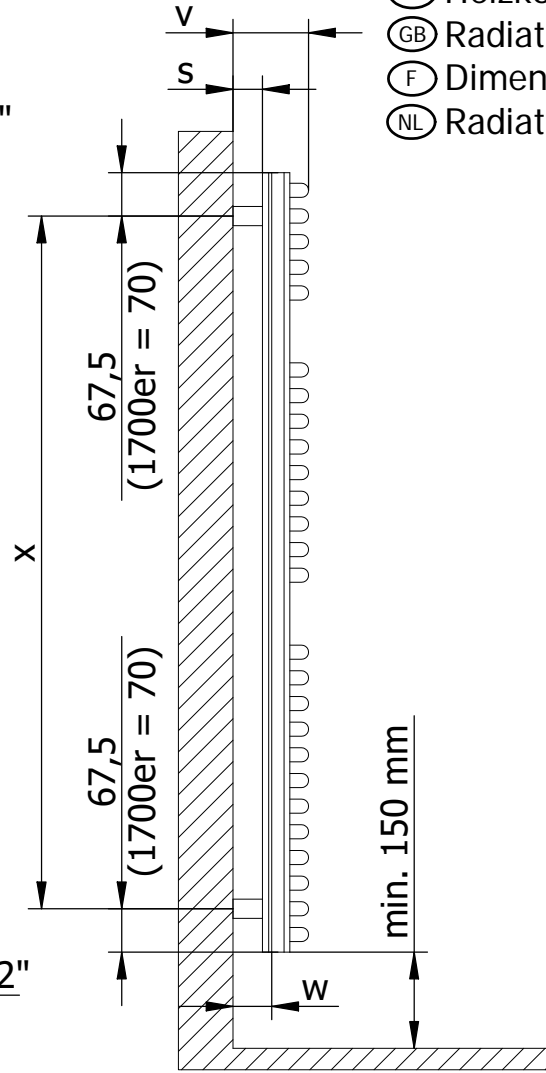
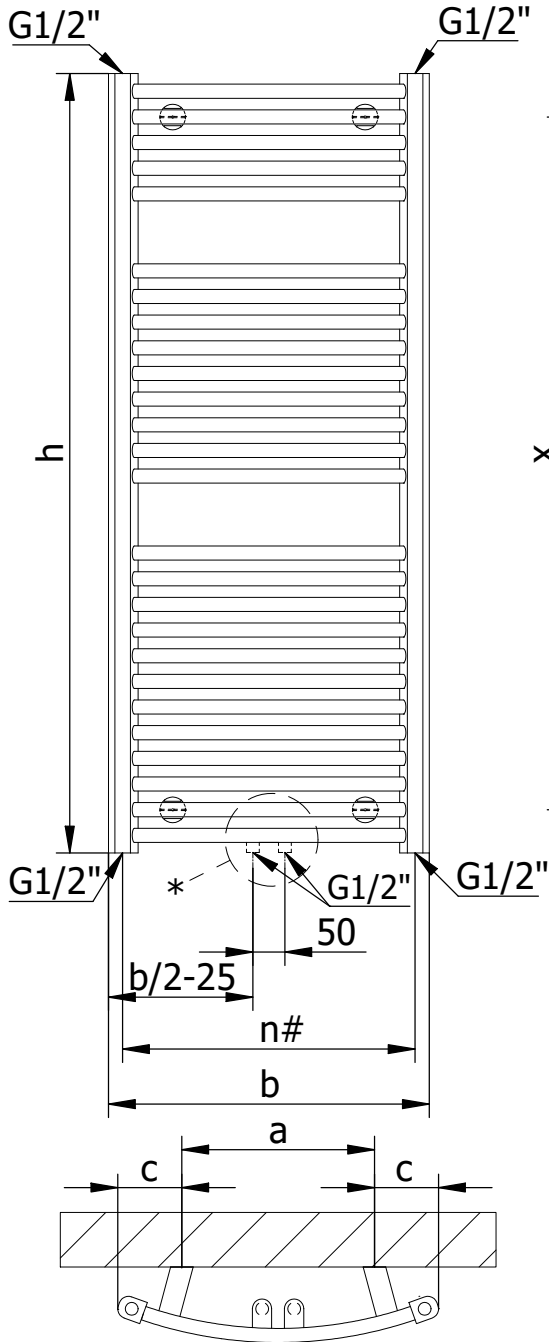

- * - Nur bei Heizkörpern mit Mittenanschluss.
- * - only radiators with center connection.
- * - Uniquement pour les radiateurs à raccord central.
- * - alleen bij radiatoren met middenaansluiting.

- # - ist bedeutungslos bei Heizkörpern mit Mittenanschluss
- # - irrelevant in case of radiator with centre connector
- # - Sans importance pour les radiateurs à raccord central.
- # - is onbelangrijk bij radiatoren met middenaansluiting

LG = Leergewicht, empty weight, poids à vide, leergewicht,
 F = Füllvolumen, filling volume, volume de remplissage, vulhoeveelheid,

h	b	n#	a	c	x	w	s	v	LG (kg)	F (L)	Watt
695	500	465	310	95	560	32 - 37	16 - 21	102 - 107	5,3	2,7	309
1135	600	565	300	150	1000	32 - 37	16 - 21	102 - 107	9,8	5,1	601
1535	600	565	300	150	1400	32 - 37	16 - 21	102 - 107	13,1	6,9	818
1700	600	565	300	150	1565	32 - 37	16 - 21	102 - 107	14,1	7,4	888

Alle Maßangaben unterliegen einer Toleranz von $\pm 2\text{mm}$

1

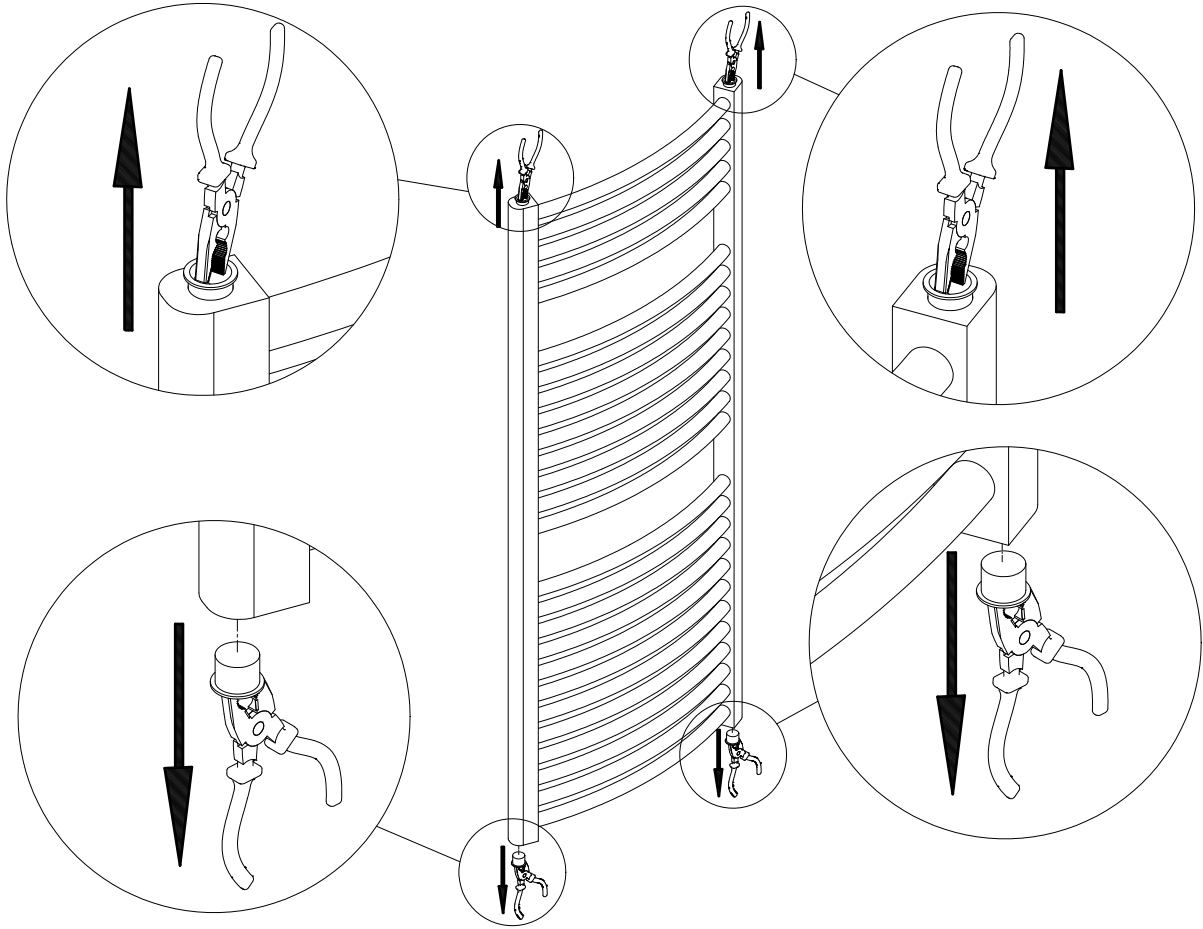

2

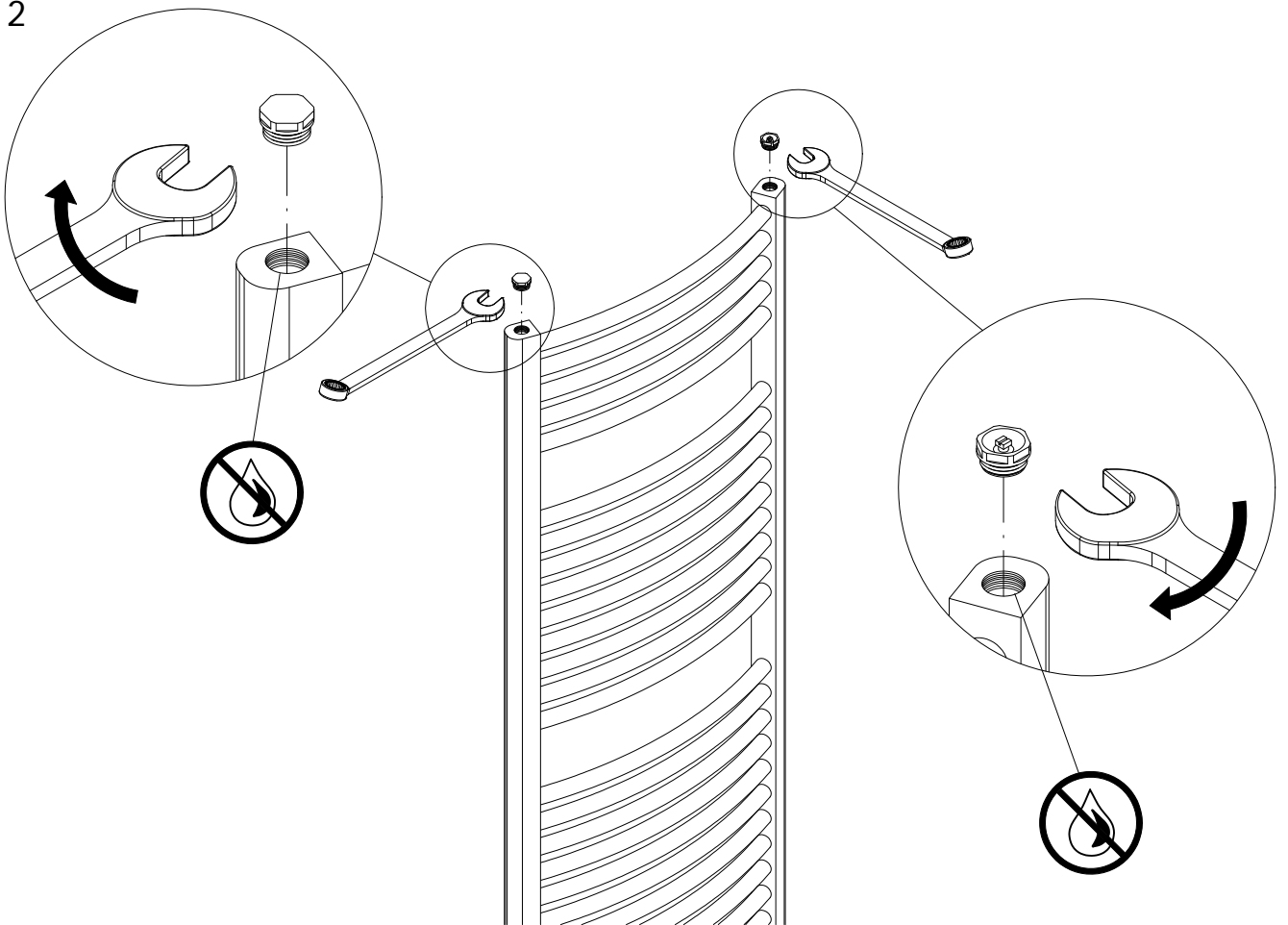

3

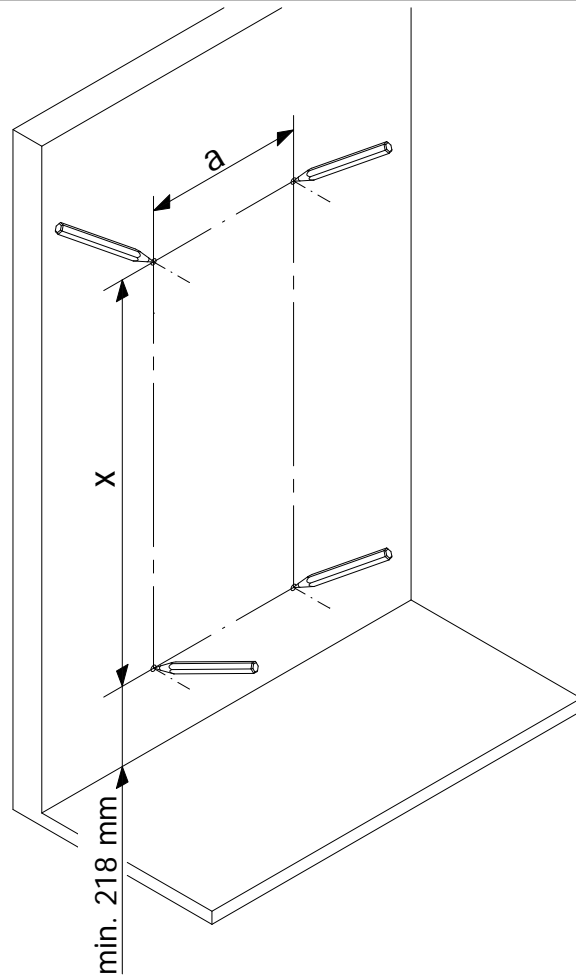

4

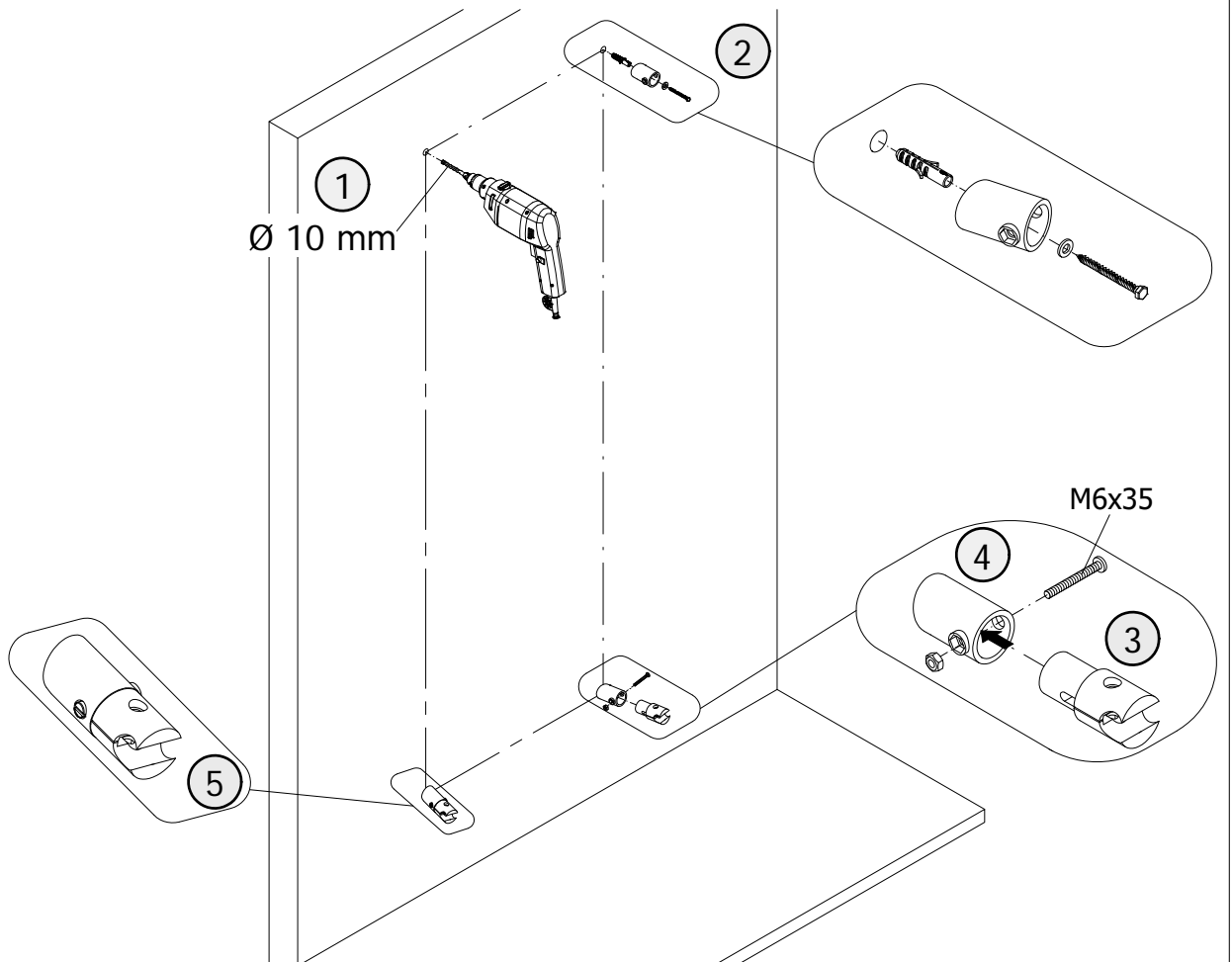

5

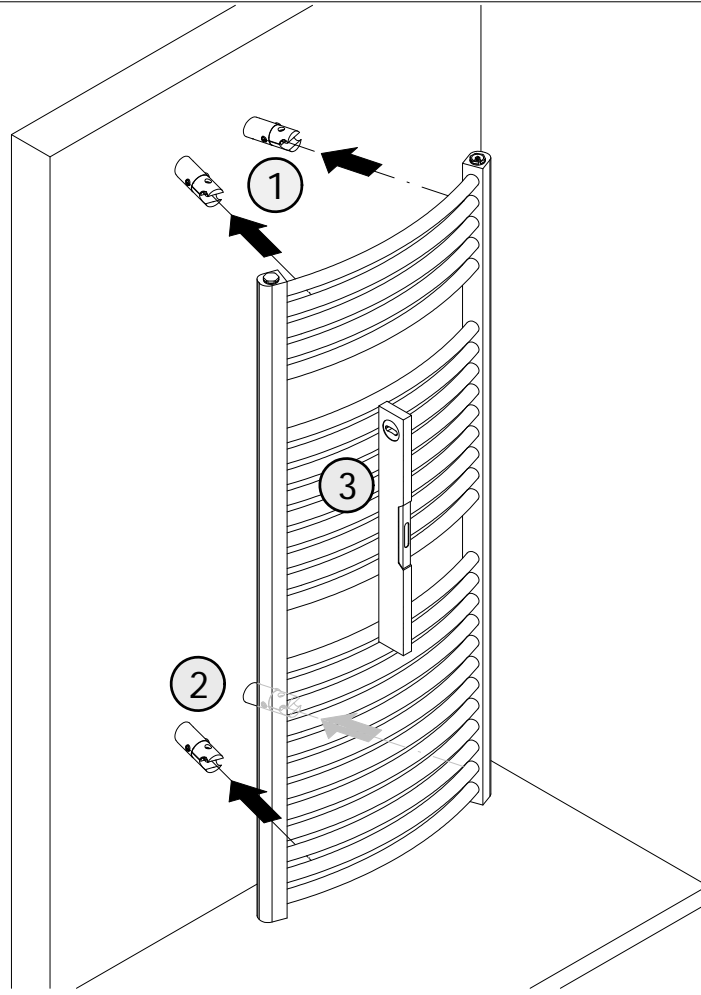

6

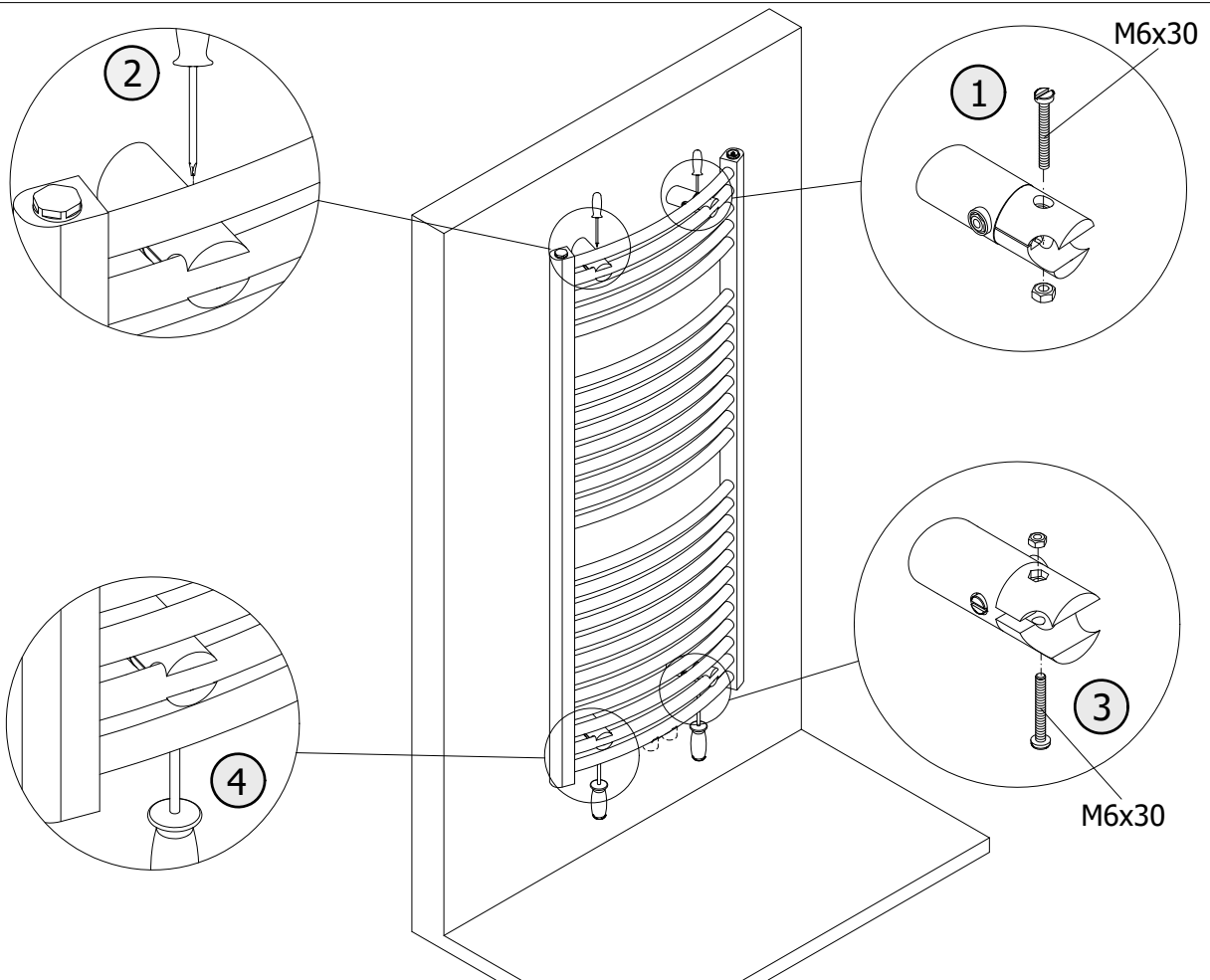





FAQ

Störung	Ursache	Fehlersuche (Eingrenzung)	Abhilfe
Der Heizkörper wird nicht oder nur leicht warm.	gestörte Zirkulation	Luft im Heizkörper Anschlussituation (Vorlauf / Rücklauf) Heizkörper ist unterversorgt	Entlüften Sie den Heizkörper. Prüfen Sie, ob der Vorlauf / Rücklauf korrekt angeschlossen ist. Führen Sie einen hydraulischen Abgleich durch.
Der Heizkörper macht Geräusche.	gestörte Zirkulation Anlagendruck / Versorgungsleistung gestört	Luft im Heizkörper Ventil regelt nicht Voreinstellung der Ventile	Entlüften Sie den Heizkörper. Prüfen Sie die Ventile und den Thermostatkopf. Führen Sie einen hydraulischen Abgleich durch.
Der Heizkörper knackt in der Aufheiz- und Abkühlphase.	Ausdehnungsgeräusche bei Temperaturanstieg- bzw. Abfall, Spannungen im System		Hier liegt keine Gefahr vor und es ist keine Handlung erforderlich.
Der Heizkörper weist Mängel in der Montage oder in der Optik auf.			Wenden Sie sich an den Vertreter des Produktes.
Der Heizkörper soll mit einem Heizkostenverteiler ausgestattet werden.			Wenden Sie sich an den Hersteller des Heizkostenverteilers.

Problem	Reason	Trouble-shooting	Remedy
The radiator is luke warm	circulation blocked	Air in the radiator Connection issue (reverse in/out flow) Radiator needs bleeding	Bleed the radiator Check the non return valve is connected properly Perform a hydraulic balancing
The radiator makes unusual noises	circulation blocked system pressure incorrect - adjust accordingly	Air in the radiator Valve not regulating Faulty valves	Bleed the radiator Check the valves and thermostatic control Perform a hydraulic balancing
The radiator "pulses" in the heating and cooling mode.	Expansion noises when using a heating rod or particles are circulating in the system.		Here, there is no risk and no action required.
The radiator has visual impairments/defects			Please contact the retailer of the product.
The radiator should be equipped with a thermostatic control or heating rod.			Contact the manufacturer of the thermostatic control or heating rod.

Dysfonctionnement	Cause(s)	Détection des erreurs	Solution(s) Proposée(s)
Le radiateur ne chauffe pas ou très peu.	circulation bloquée	présence d'air dans le radiateur problème de connexion du circulateur alimentation insuffisante	purger le radiateur. vérifier si le clapet de retenue a été installé correctement. effectuer un équilibrage hydraulique.
Le radiateur fait un bruit anormal.	circulation bloquée pression / alimentation incorrecte	présence d'air dans le radiateur la vanne thermostatique ne régule pas. paramétrage de la vanne thermostatique.	purger le radiateur. vérifier la vanne et la tête thermostatique. effectuer un équilibrage hydraulique.
Craquement lors de la chauffe ou refroidissement du radiateur.	Bruits provoqués par la dilation des tuyaux lors de la chauffe, refroidissement, ou par des tensions au coeur du système.		Aucun danger, aucune action n'est nécessaire.
Le radiateur présente un défaut technique ou optique.			Prendre contact avec votre revendeur.
Le radiateur doit être équipé d'un système de répartiteur de frais de chauffage.			Prendre contact avec votre fournisseur d'énergie.

storing	oorzaak	storingzoeken (beperking)	oplossing
De radiator wordt niet of slechts gedeeltelijk warm.	onderbroken circulatie	lucht in de radiator verwisseling aanvoer/retour) watertoevoer naar radiator is te gering	ontlucht de radiator. controleer of aanvoer/retour juist is aangesloten. maak een hydraulisch vergelijk.
De radiator maakt geruis.	gestoorde circulatie installatiedruk / verzorgingscapaciteit onvoldoende	lucht in de radiator radiatorkraan regelt niet juist. voorstelling van radiatorkraan niet juist.	ontlucht de radiator. controleer de radiatorkraan en thermostaatkop. maak een hydraulisch vergelijk.
De radiator "knakt" bij het warmworden en afkoelen.	Uitzettingsgeluiden bij temperatuurstijging resp. afkoeling, spanning in het systeem.		Hier bestaat geen gevaar en is geen ingreep noodzakelijk.
De radiator heeft onvolkomenheden bij de montage of optisch.			Neem contact op met de verkoper van het product.
De radiator moet worden voorzien van een warmtekostenverdelers.			Neem contact op met de fabrikant van de warmteleverancier.

			
1015	1015	1015	1015
Schulte Home GmbH & Co. KG Am Lindhövel 1 59846 Sundern Germany	Schulte Home GmbH & Co. KG Am Lindhövel 1 59846 Sundern Germany	Schulte Home GmbH & Co. KG Am Lindhövel 1 59846 Sundern Germany	Schulte Home GmbH & Co. KG Am Lindhövel 1 59846 Sundern Germany
17 Heizkörper aus Stahl EUROPA H280695(-M); H281135(-M) H281535(-M); H281700(-M)	17 steel radiator EUROPA H280695(-M); H281135(-M) H281535(-M); H281700(-M)	17 Radiateur en acier EUROPA H280695(-M); H281135(-M) H281535(-M); H281700(-M)	17 Stalen radiator EUROPA H280695(-M); H281135(-M) H281535(-M); H281700(-M)
EN 442-1: 2014 LE/SH-Nr.02 A/2019-01 In Heizsystemen in Gebäuden	EN 442-1: 2014 LE/SH-Nr.02 A/2019-01 Heating systems in buildings	EN 442-1: 2014 LE/SH-Nr.02 A/2019-01 Pour les systèmes de chauffage central des bâtiments résidentiels	EN 442-1: 2014 LE/SH-Nr.02 A/2019-01 In verwarmingsinstallaties in gebouwen
Brandverhalten: A1 Druckdichtigkeit: - keine Undichtigkeit bei 1,3 x MOP - Maximaler Betriebsdruck (MOP) 1000 kPa Druckfestigkeit: - kein Riss bei 1,69 x MOP - Maximaler Betriebsdruck (MOP) 1000 kPa Oberflächentemperatur: bis +95°C Nennwärmeleistung: - 695x500 mm: $\Phi 30 = 162 \text{ W}$; $\Phi 50 = 309 \text{ W}$ - 1135x600 mm: $\Phi 30 = 316 \text{ W}$; $\Phi 50 = 601 \text{ W}$ - 1535x600 mm: $\Phi 30 = 430 \text{ W}$; $\Phi 50 = 818 \text{ W}$ - 1700x600 mm: $\Phi 30 = 471 \text{ W}$; $\Phi 50 = 888 \text{ W}$ Kennlinie: - 695x500 mm: $\Phi = 2,2398 \cdot \Delta T^{1,2595}$ - 1135x600 mm: $\Phi = 4,3518 \cdot \Delta T^{1,2599}$ - 1535x600 mm: $\Phi = 5,9144 \cdot \Delta T^{1,2602}$ - 1700x600 mm: $\Phi = 6,9696 \cdot \Delta T^{1,2390}$ Beständigkeit: Korrosionsbeständigkeit: keine Korrosion nach 100 h Feuchtigkeit Beständigkeit gegen kleinere Stoßbeschädigungen: Klasse 0	Fire behaviour: A1 Pressure tightness: - no leakage at 1,3 x MOP - Maximum operating pressure (MOP) 1000 kPa Resistance to pressure: - no breakage at 1,69 x MOP - Maximum operating pressure (MOP) 1000 kPa Surface temperature: Maximum +95°C Rated thermal output: - 695x500 mm: $\Phi 30 = 162 \text{ W}$; $\Phi 50 = 309 \text{ W}$ - 1135x600 mm: $\Phi 30 = 316 \text{ W}$; $\Phi 50 = 601 \text{ W}$ - 1535x600 mm: $\Phi 30 = 430 \text{ W}$; $\Phi 50 = 818 \text{ W}$ - 1700x600 mm: $\Phi 30 = 471 \text{ W}$; $\Phi 50 = 888 \text{ W}$ Characteristic curve: - 695x500 mm: $\Phi = 2,2398 \cdot \Delta T^{1,2595}$ - 1135x600 mm: $\Phi = 4,3518 \cdot \Delta T^{1,2599}$ - 1535x600 mm: $\Phi = 5,9144 \cdot \Delta T^{1,2602}$ - 1700x600 mm: $\Phi = 6,9696 \cdot \Delta T^{1,2390}$ Durability as: Resistance against corrosion: no corrosion after 100 h humidity Resistance against minor impact: Class 0	Comportement au feu: A1 Etanchéité à la pression: - pas de fuite à 1,3 x MOP - Pression de service Maxi. Autorisée (MOP) 1000 kPa Résistance à la pression: - Pas de fissure à 1,69 x MOP - Pression de service Maxi. Autorisée (MOP) 1000 kPa Température de surface: jusqu'à +95°C Puissance thermique nominale : - 695x500 mm: $\Phi 30 = 162 \text{ W}$; $\Phi 50 = 309 \text{ W}$ - 1135x600 mm: $\Phi 30 = 316 \text{ W}$; $\Phi 50 = 601 \text{ W}$ - 1535x600 mm: $\Phi 30 = 430 \text{ W}$; $\Phi 50 = 818 \text{ W}$ - 1700x600 mm: $\Phi 30 = 471 \text{ W}$; $\Phi 50 = 888 \text{ W}$ Courbe caractéristique: - 695x500 mm: $\Phi = 2,2398 \cdot \Delta T^{1,2595}$ - 1135x600 mm: $\Phi = 4,3518 \cdot \Delta T^{1,2599}$ - 1535x600 mm: $\Phi = 5,9144 \cdot \Delta T^{1,2602}$ - 1700x600 mm: $\Phi = 6,9696 \cdot \Delta T^{1,2390}$ Résistance: Résistance à la corrosion : aucune apparition de corrosion après 100 h de test en milieu humide Résistance aux légers impacts : Degré 0	Brandgedrag: A1 Drukresistentie: - geen lekkage bij 1,3 x MOP - Maximale bedrijfsdruk (MOP) 1000 kPa Drukvastheid: - scheurt niet bij 1,69 x MOP - Maximale bedrijfsdruk (MOP) 1000 kPa Oppervlakte temperatuur: tot +95°C Nominale warmteafgifte: - 695x500 mm: $\Phi 30 = 162 \text{ W}$; $\Phi 50 = 309 \text{ W}$ - 1135x600 mm: $\Phi 30 = 316 \text{ W}$; $\Phi 50 = 601 \text{ W}$ - 1535x600 mm: $\Phi 30 = 430 \text{ W}$; $\Phi 50 = 818 \text{ W}$ - 1700x600 mm: $\Phi 30 = 471 \text{ W}$; $\Phi 50 = 888 \text{ W}$ Kenmerkende curve: - 695x500 mm: $\Phi = 2,2398 \cdot \Delta T^{1,2595}$ - 1135x600 mm: $\Phi = 4,3518 \cdot \Delta T^{1,2599}$ - 1535x600 mm: $\Phi = 5,9144 \cdot \Delta T^{1,2602}$ - 1700x600 mm: $\Phi = 6,9696 \cdot \Delta T^{1,2390}$ Resistentie: Corrosie resistentie: geen corrosie na 100u vochtigheid Resistentie tegen kleinere stootbeschadigingen: Klasse 0



Duschservice
Zum Hohlen Morgen 22
59939 Olsberg
Deutschland / Germany / Allemagne / Duitsland



Ersatzteilbestellung:
Fax 02962 / 972-4260



Allgemeine technische Probleme:
Telefon 02962 / 972-40



E-Mail:
ersatzteile@duschservice.de