

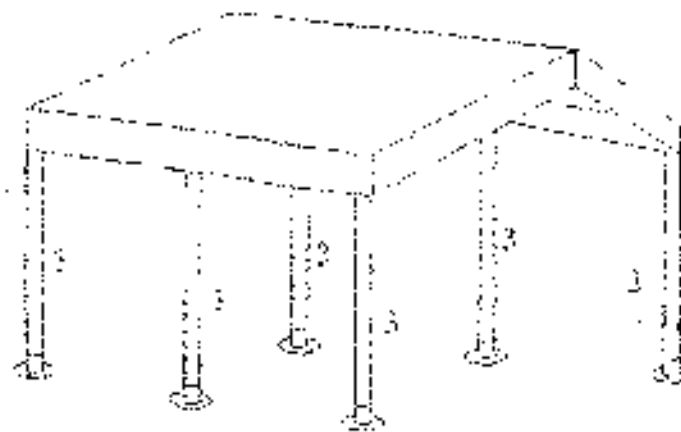

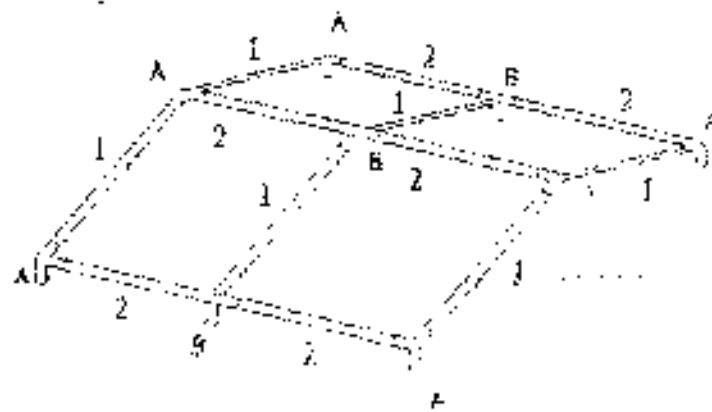







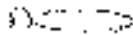
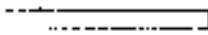

THE INSTRUCTION FOR 3×4M PE PARTY TENTS

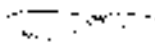
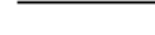

#1		1510×38×1.0mm - 6 PCS		40 PCS
#2		1930×38×1.0mm - 6 PCS		4 PCS
#3		1930×38×1.0mm - 6 PCS		1 PCS
A		6 PCS		2 PCS
B		3 PCS		4 PCS
C		6 PCS		6 PCS
D		4 PCS		4 PCS