

①

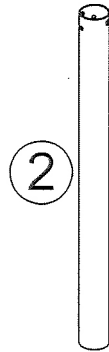

②

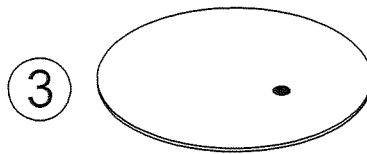

③

①



1PC

②



1PC

③



1PC

A × 1



M6×60 mm

B × 2



M4×8 mm

C × 1



M8×25 mm

D × 1



E × 4





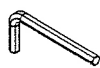

F × 1

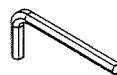

G × 1



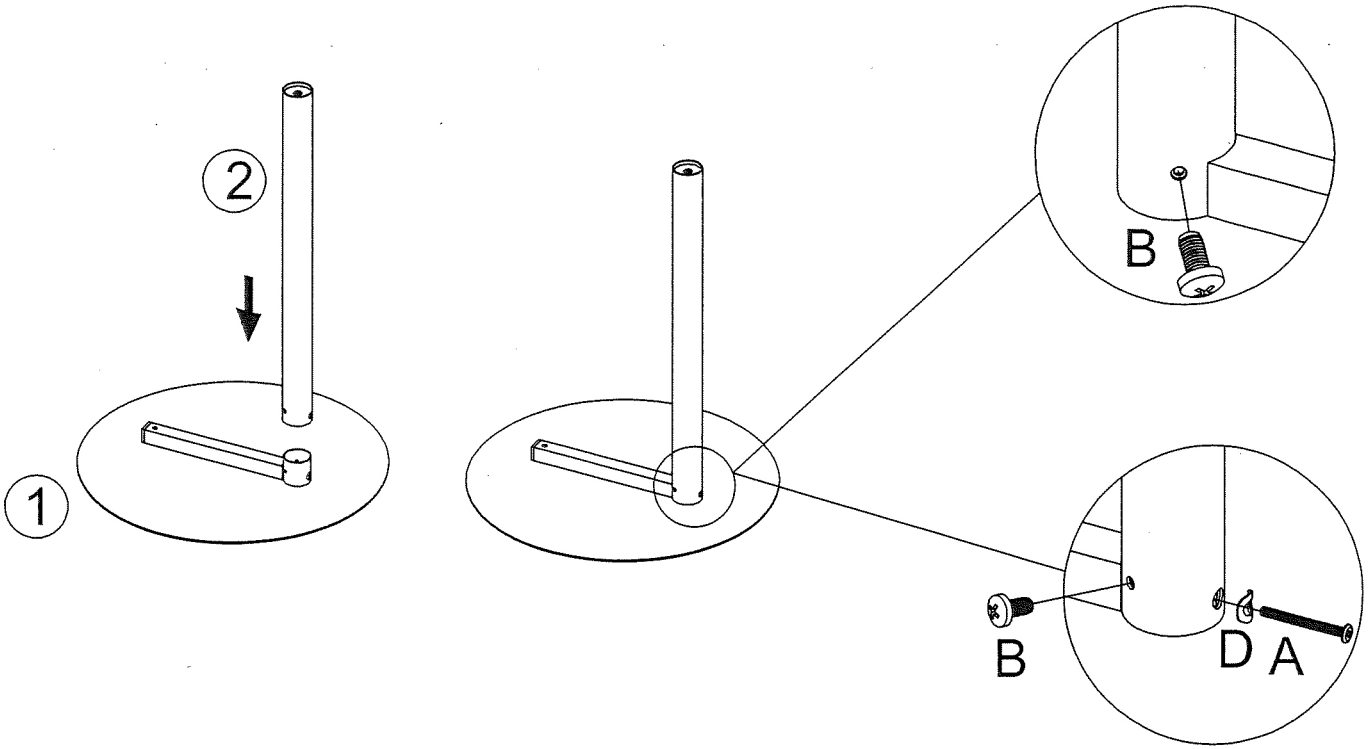

1

A × 1  M6×60 mm	B × 2  M4×8 mm	D × 1 	F × 1 
--	---	--	--



2

C × 1  M8×25 mm	G × 1 
--	--

