



EN

PORTABLE AIR CONDITIONER (LOCAL)

ZELOS



OPERATING INSTRUCTIONS

Read the instructions carefully before operating the appliance or carrying out maintenance work. Observe all the safety instructions; failure to observe the instructions may lead to accidents and/or damage. Store these instructions in a safe place for future reference.



Appliance filled with flammable gas R290.



Before installing and using the appliance, read the owner's manual.



Before repairing the appliance, read the service manual.

The Refrigerant R290

- To realize the function of the air conditioner unit, a special refrigerant circulates in the system. The refrigerant is the fluoride R290 = 3 GWP (Global warming potential). This refrigerant is flammable and inodorous. It can lead to explosions under certain conditions, however the flammability of this refrigerant is very low and it can be ignited only by fire.
- Compared to other common refrigerants, R290 is a non-polluting refrigerant with no harm to the ozoneosphere and a no effect upon the greenhouse effect. R290 has very good thermodynamic features which lead to a really high energy efficiency. The units therefore need less filling.

Warning:

Do not try to accelerate the defrosting process or to clean the appliance in different ways other than those recommended by the manufacturer. Should repair be necessary, contact your nearest authorized Argoclima Service Centre. Any repairs carried out by unqualified personnel may be dangerous. The appliance has to be stored in a room that doesn't have any continuously operating ignition sources. (for example: open flames, an operating gas appliance or an operating electric heater.) Do not pierce or burn. Do not pierce any part of refrigerant circuit.

Appliance has to be installed, operated and stored in a room with a floor area larger than 4 m². For repairs, strictly follow manufacturer's instructions only for appliances filled with R290 flammable gas. Be aware that refrigerants do not have any odour.

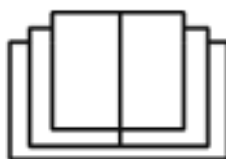

GENERAL OPERATING AND SAFETY INSTRUCTIONS

- This appliance is a local air conditioner designed for domestic use.
- Only use this air-conditioner as described in this manual.
- Ensure that the required voltage and frequency (220-240 V/50 Hz) match the available power source.
- Fuse style T, 250V AC, 2A or higher, the electricity passing through the fuse cannot be above 2A.
- This appliance can be used by children aged from 8 years and above and people with reduced physical, sensory or mental capabilities or lack of experience and knowledge if they have been given supervision or instruction concerning use of the appliance in a safe way and understand the hazards involved.
- Children shall not play with the appliance.
- Do not insert fingers, rods into the air outlet. Take special care to warn children of these dangers.
- Cleaning and user maintenance shall not be made by children without supervision.
- Ensure that the electricity system is able to deliver the operating current required by the air conditioner, in addition to that normally absorbed by other appliances (household appliances, lighting system, etc.). Please refer to the maximum power input data indicated on the air conditioner's data plate.
- Connection to the electricity grid must take place in accordance with current installation standards.
- Ensure that the automatic switches and system protection valves are able to withstand a start-up current of 4A (normally for less than 1 second).
- The system socket must always be fitted with an efficient earth connection.
- Make sure that the plug is fully inserted. Do not use multiple adapters. Do not touch the plug with wet hands. Make sure that the plug is clean.

- Do not use the plug as a means by which to start/stop the air conditioner: use the ON/OFF button on the remote control or on the control panel.
- Do not install the air conditioner in rooms where it may receive water splashes (e.g. laundry rooms, bathrooms, showers and swimming pools).
- This air conditioner can be used by children of 8 years of age or older, and by persons with reduced physical, sensory and mental abilities or who lack the necessary know-how and experience to operate it, if under the supervision or instruction of a person responsible for their safety, so that they are fully aware of the attendant risks.
- Before moving or cleaning the device, ensure that it is unplugged from the socket.
- Do not move the air conditioner while it is operating; first turn the appliance off, check for any condensate build-up and empty it if necessary.
- To turn the appliance off, set the remote control to OFF and remove the plug from the socket. Pull on the plug only. Do not pull the cord.
- **Do not use the appliance if the cord or plug are damaged.** If the power supply cord is damaged, it must be replaced by the manufacturer, dealer or a similarly qualified person so as to avoid any safety risks. Do not try to repair or replace the power cord, risk of electric shock.
- Keep the unit away from fire, possible fire sources, inflammable or explosive objects or oils are likely to splash.
- Do not leave the unit unattended while it's operating, turn the unit off and unplug it.
- Do not splash or pour water on the air conditioner

PRECAUTION!

Do not insert any objects into the air conditioner: this is very dangerous as the fan rotates at high speed.

- **Ensure that air circulates freely around the unit. Do not cover the air intake and delivery grilles with drapes or other items.**
- **To avoid the possibility to fire disaster, the air conditioner shall be not covered.**

WARNING!

- **The air conditioner must be positioned at least 50 cm away from the wall or other obstacles, on a flat and stable surface so as to avoid water leakages.**
- **The air conditioner is equipped with a compressor overload protection system, whereby the compressor only starts once 3 minutes have elapsed from its previous stoppage.**
- **Please wait at least 3 minutes before starting the unit. This helps to prevent the compressor from being damaged.**

WARNING!

In the event of an anomaly, a strange noise, a smell or a smoke, switch the appliance off and unplug from the socket. Do not dismantle or attempt to repair or modify the product. In the event of a malfunction, contact the after-sales service centre directly.

WARNING!

- **Do not expose the air conditioner to direct sunlight.**
- **Do not use insecticides, oils, detergents or spray paints near the appliance; do not use aggressive chemical detergents to clean the casing as this may damage the finish and colour.**
- **Close all open windows to maximise air conditioning efficiency.**

The manufacturer shall not be held liable if the relevant safety and accident prevention rules are not observed.

DESCRIPTION OF THE APPLIANCE

FRONT VIEW

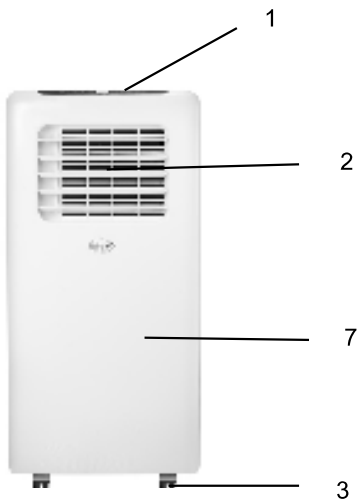

- 1) CONTROL PANEL AND FUNCTION BUTTONS WITHOUT REMOTE CONTROL
- 2) HORIZONTAL FINS AND AIR INTAKE
- 3) WHEELS
- 4) LATERAL AIR INPUT
- 5) LATERAL REMOVABLE FILTER
- 6) REAR PANEL
- 7) FRONT PANEL
- 8) POWER CORD
- 9) AIR INPUT AND REAR REMOVABLE FILTER
- 10) REMOTE CONTROL

SIDE VIEW

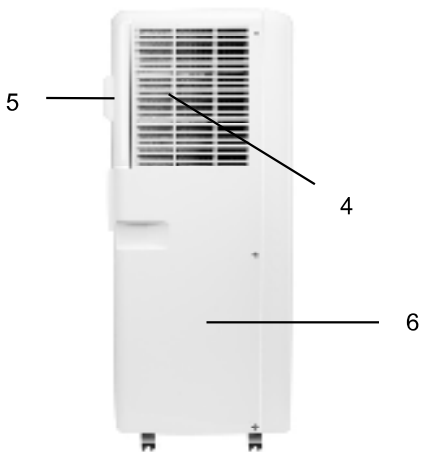

REAR VIEW

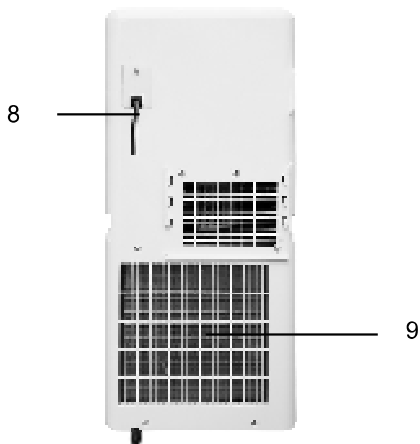

Min/max operating limits (internal temperature)

Cooling: 18 °C DB / 35 °C DB

Dehumidification: 16 °C DB / 35 °C DB

Cooling mode room temperature adjustment range: 16 °C DB / 31 °C DB

APPLIANCE START-UP

Open the packaging and remove the box from above. Remove the product and the other elements supplied (illustrated in the box below).

Remote control



Type
AAA
batteries
for the
remote
control



Round fitting to position between the air discharge outlet and the flexible pipe.



Hose

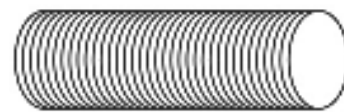

End fitting for window



Window unit kit with plug.



Round fitting for window unit, for positioning between the end of the tube and the window unit itself.



Drainage tube.

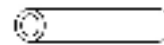

Position the product vertically on a flat and stable surface, as close as possible to a window and at least 50 cm from walls or other nearby obstacles.

USE WITH END FITTING FOR WINDOW

Connect the flat fitting to the hose, extend the hose as far as necessary for reaching the outside and it connect to the back of the air conditioner.

Next, slide the flat fitting downwards into the grooves (A) and secure it with the hook (B).

The upward-facing side of the flat fitting is marked "TOP".

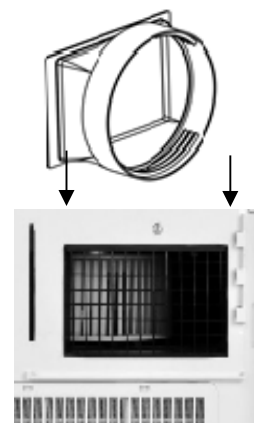
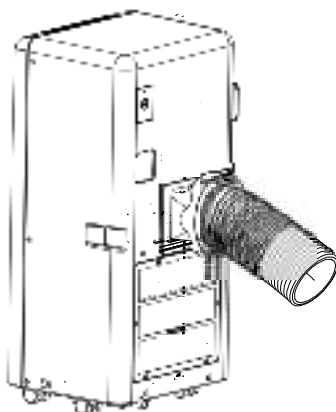

Connect the round window fitting (1) to the end of the hose then the end fitting for the window (2), previously obtained by joining parts A and B

Open the windows and lock one of the two leaves with the handle. Place the end fitting against the fixed leaf of the window, and draw the other leaf towards it.

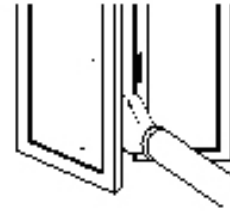
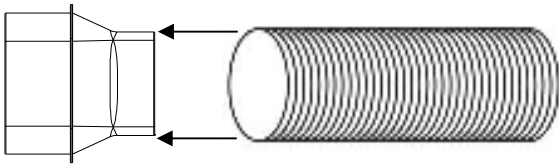

USE WITH WINDOW UNIT KIT

To make the hole in the glass it is advisable to bring the window kit to the glazier as well.

Insert the window unit without its closure cap into the window. Insert the round fitting into the retractable hose and insert the retractable hose with the round fitting into the window unit.

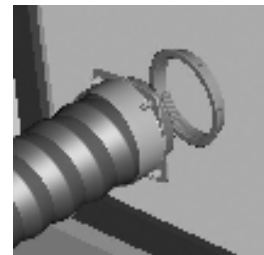
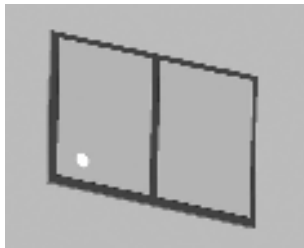

Insert the flat fitting onto the hose.

Insert the assembled hose into the back of the air conditioner.

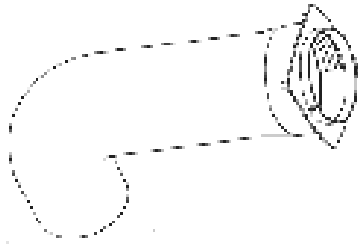

The outlet must be between 40 cm and 130 cm above the ground.

Avoid tight curves or bends in the flexible hose.

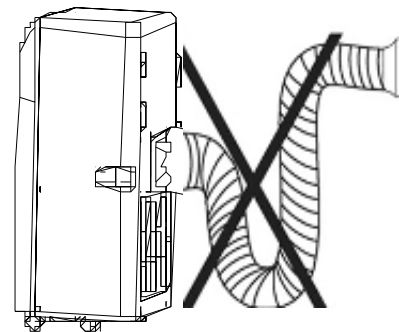
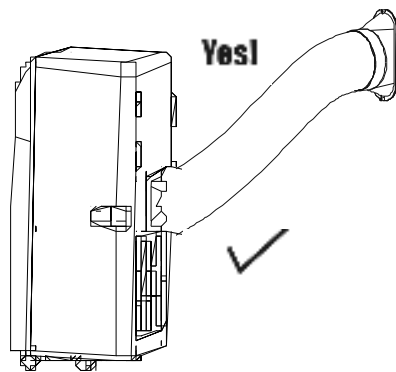

When the air conditioner is not being used, disconnect the hose and fit the closing cap.

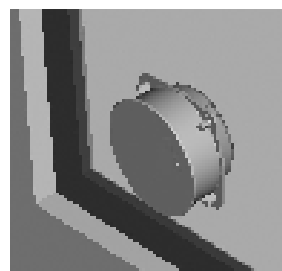

Connect the power cord to a suitable electrical socket (220-240 V). Insert the batteries supplied into the remote control, while observing the polarities. Select the desired operating mode from the remote control.

HOW TO USE THE APPLIANCE

This appliance can be used for cooling, dehumidifying and ventilating.

When switching between modes, the fan continues to rotate but the compressor stops: the compressor will start after 3 minutes. This delay protects the compressor from potential damage.

THE DISCHARGE TUBE MUST ALWAYS BE CONNECTED to the appliance: the only exception is when the appliance is used solely for dehumidification, in which case it is advisable to let the appliance discharge directly into the environment for maximum efficiency (consult the "Dehumidification Mode" paragraph).

Regularly clean the air filters beneath the easily removable rear grille to keep the air conditioner working efficiently.

It is advisable to put a thickness of a few centimeters under the product to ensure an adequate slope of the continuous condensate drain pipe.

OPERATING MODES

1. COOLING MODE (COOL)

- The "Cool" LED on the control panel will turn on.
- The temperature can be adjusted to between 16 °C and 31 °C.
- In this mode, the fan speed can be adjusted and the Timer function can be set.
- For more silent operation, run the fan at low speed.

2. DEHUMIDIFICATION MODE (DEHUM)

- Press the MODE button to select Dehumidification.
- The temperature is automatically set 2 degrees below the room temperature.
- The fan speed is set to low and cannot be adjusted.

NOTE

The air conditioner does not cool the room when it is used as a dehumidifier.

When the appliance is used as a dehumidifier, the flexible hose must not be connected.

For maximum dehumidification efficiency, leave the rear discharge attachment free to discharge directly into the environment.

The dehumidification mode is recommended during autumn and winter.

If used in summer, it is best to leave the flexible hose attached so that the hot air can be discharged towards the outside rather than into the room.

3. VENTILATION MODE (FAN)

- Press the MODE button to select Fan and wait until the relative icon appears.
- Press SPEED to set the ventilation speed.
- The temperature cannot be adjusted.

CONDENSATE ELIMINATION

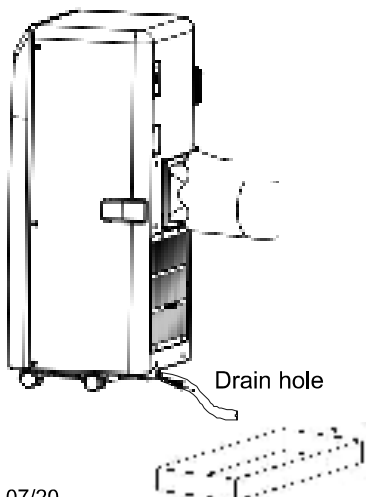

This appliance automatically vaporises condensate in cooling mode.

Ensure that when the unit is operating in cooling mode, the rubber caps closing the drainage holes on the rear of the appliance are properly positioned. When the tank is full, the "Full Tank" led will light up (button W.F. on display)

To empty the container, switch the air conditioner off and unplug it. Remove the cap from the rear drainage hole and direct it over a normal drain.

Ensure that the tube is not twisted or bent. The tube must slope downwards. Re-close the drainage hole with the cap and resume use of the air conditioner.

WARNING!

Continuous Condensate

When using the air conditioner in dehumidification mode, we recommend always ensuring continuous drainage, in order to maximise dehumidification efficiency.

Use the low drainage outlet on the appliance. The water can be drained into a drain by simply connecting the supplied drainage tube.

It is advisable to put a thickness of a few centimeter under the product to ensure an adequate slope of the continuous condensate drain pipe.

REMOTE CONTROL OPERATION

Insert the batteries into the remote control, while respecting the indicated polarities.

Only use type AAA 1.5V batteries.

Remove the batteries if the remote control is not used for a month or longer.

Do not attempt to recharge the batteries. Replace all batteries at the same time.

Do not throw the batteries into fire: they may explode.

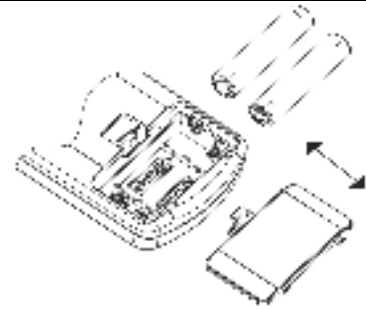

INFORMATION FOR CORRECT DISPOSAL OF THE BATTERIES PURSUANT TO EUROPEAN DIRECTIVE 2006/66/EC and amendments Directive 56/2013/EC

Replace the batteries when depleted. At the end of their working life, batteries must be disposed of separately from unsorted waste. They must be delivered to appropriate separated waste disposal plants or to dealers that provide a similar service. Separate waste disposal of batteries prevents potential negative effects on the environment and human health resulting from inadequate disposal, and also allows the materials from which it is made to be recovered and recycled in order to achieve significant savings in terms of energy and resources. The separate disposal obligation is underlined by the crossed-out dustbin symbol appearing on the battery. Illegal disposal of the product by the user is subject to administrative penalties as per current regulations.

FOR OPTIMAL REMOTE CONTROL OPERATION, POINT THE TRANSMITTER HEAD TOWARDS THE RECEIVER LOCATED ON THE AIR CONDITIONER.

The remote control can be activated by pressing the ON/OFF button on the portable unit. The icon on the remote control display will flash once and a buzzer will sound to indicate that the signal was transmitted to the air conditioner.

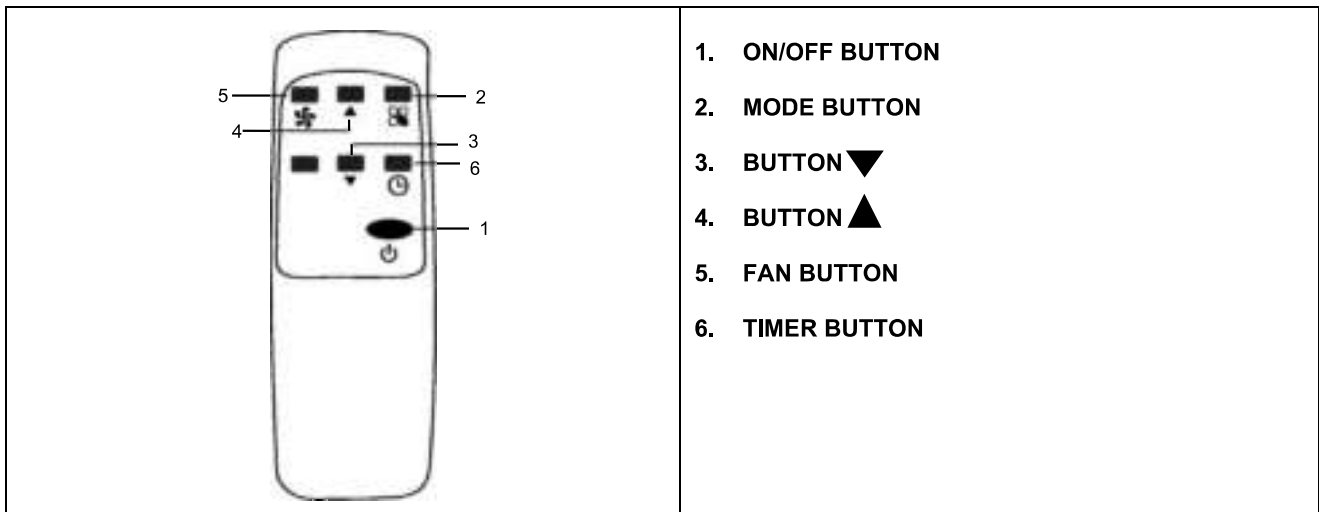

1. ON/OFF BUTTON
2. MODE BUTTON
3. BUTTON ▼
4. BUTTON ▲
5. FAN BUTTON
6. TIMER BUTTON

CONTROL PANEL

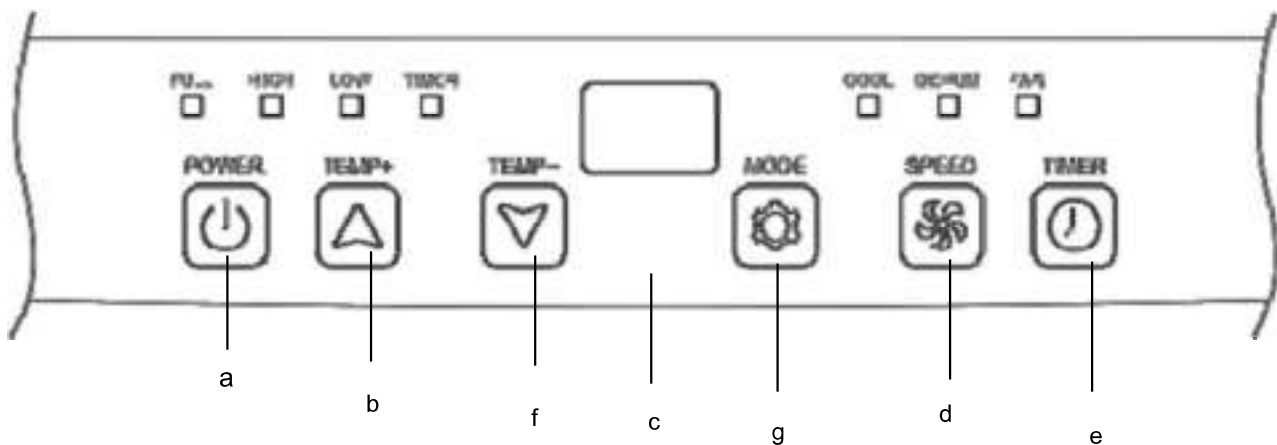

- a. POWER ON/OFF BUTTON
- b. BUTTON ▲
- c. RECEIVING SENSOR
- d. SPEED BUTTON
- e. TIMER BUTTON
- f. BUTTON ▼
- g. MODE BUTTON

FULL - Tank full LED - lights up red when the internal tank is full and needs to be emptied

(1) ON/OFF BUTTON

Press this button to switch the unit on or off.

(2) MODE BUTTON

When the unit is on, press this button to choose the desired mode among: COOLING, FAN and DEHUMIDIFYING.

(3) BUTTON TEMP ▼

Press this button to adjust the temperature and set the time.

(4) BUTTON TEMP ▲

Press this button to adjust the temperature and set the time.

(5) SPEED BUTTON

In the cooling and fan modes, press this button to adjust the ventilation speed to low (Low) or high (High). In certain conditions, the fan speed may not function according to the settings.

In dehumidifying mode, this button cannot be pressed, thus the fan will forcefully choose the low fan speed.

(6) TIMER BUTTON

a. When the air conditioner is off, press "TIMER" to set when to switch the unit on. Press "+" or "-" to set the time.

b. When the air conditioner is on, press "TIMER" to set when to switch the unit off. Press "+" or "-" to set the time.

TROUBLESHOOTING

Troubles	Possible Causes	Suggested Remedies
Unit does not start when pressing power button	- Water full indicator lamp blinks, and water tank is full. (W.F.)	Dump the water out of the water tank.
	- Room temperature is lower than the setting temperature.	Reset the temperature
Not cool enough	- There are heat sources inside the room.	Remove the heat sources if possible
	- The doors and windows are not closed	Make sure all the doors and windows are closed
	- Exhaust air hose is not connected or blocked.	Connect or clean the exhaust air hose.
	- Temperature setting is too high.	Reset the temperature
	- Air inlet is blocked.	Clean the air inlet.
Noisy	- The ground is not levelled or not flat enough	Place the unit on a flat, level ground if possible
	- The sound comes from the flowing of the refrigerant inside the air conditioner	It is normal.
E2 Code	- Water tank full in cooling mode	Take off the rubber stopper and empty the water tank.

CARE AND MAINTENANCE

WARNING!

Prior to carrying out any cleaning or maintenance, unplug the unit from the power socket.

1. Cleaning the air filters

The air filter must be checked at least once every two weeks of operation. Operating with dirty or clogged filters will decrease the effectiveness of the air conditioner and can cause serious problems.

To remove the filter, release the rear grille then slide out the filter by gently pulling it sideways.

Use a vacuum cleaner to remove any dust. Should this not be sufficient, wash the filter with lukewarm water (40°) and neutral detergent (if necessary), rinse it with cold water then leave it to dry naturally before putting it back in place. After putting the filter back in place, close the grille and resume use of the air conditioner.



2. Cleaning the casing.

Use a soft damp cloth to clean the outer surface of the air conditioner.

Do not use excessively hot water, solvents, petrol or other aggressive chemical compounds, talcum powder and brushes: they may damage the surface or colour of the casing.

Remove any stains using warm water with a little neutral detergent.

Do not pour water onto the air conditioner to clean it: this may damage the internal components or cause a short circuit.

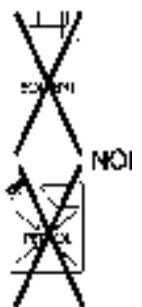
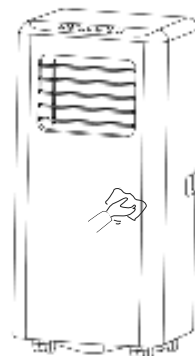

3. Storage.

When you do not envisage using the air conditioner for a long time, clean the filters before storing it away. Keep the appliance in a vertical position at all times. Do not place any heavy objects on the top and, if possible, protect the air conditioner with a plastic sheet.

4. Transport.

Preferably keep the air conditioner in the vertical position when transporting it.

Should this not be possible, rest it on its right-hand side; when it reaches its destination, immediately put the appliance in the vertical position and wait at least 4 hours before using it in the cooling mode.

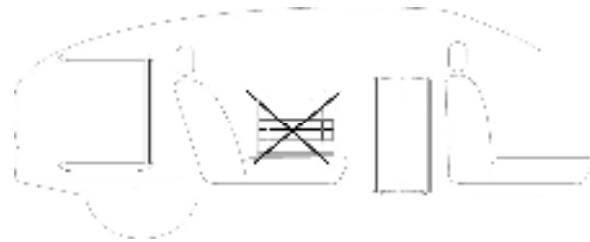

5. For complete safety, regularly check the condition of the power cord; should it be damaged through use, contact the Service Centre to replace it.

TIPS FOR MAXIMISING COMFORT AND MINIMISING CONSUMPTION

CHECK that:

- the unit's extraction and delivery grilles are always unobstructed;
- the air filters are always clean: a dirty filter will decrease the passage of air and thus reduce the unit performance;
- the doors and windows are closed, to avoid infiltration of unconditioned air;
- the flexible hose is correctly positioned, without folds or sharp bends;
- the room temperature is above 16 °C for the cooling mode, and above 16 °C for dehumidification mode.

REGULATION (EU) No. 517/2014 - F-GAS

The unit contains R290, a natural gas with global warming potential (GWP) = 3. Do not release R290 into the atmosphere.

Kg. 0.14 = 0.00042 Tonn CO₂ equiv



INFORMATION FOR THE CORRECT DISPOSAL OF THE PRODUCT IN ACCORDANCE WITH EUROPEAN DIRECTIVE 2012/19/EU

This appliance may not be scrapped with domestic waste at the end of its life cycle. We call your attention to the crucial role played by the consumer in the re-use, recycling and other forms of recovery of such waste. The appliance must be scrapped by a sorted waste disposal centre or by returning it to the retailer (no charge is levied for this service), when you purchase a new equivalent appliance. Sorted disposal of electric and electronic equipment prevents the negative effects on the environment and human health resulting from improper scrapping, and also allows the materials from which it is made to be recovered and recycled, with significant savings in terms of energy and resources. The sorted disposal requirement is indicated by the crossed waste bin label affixed to the appliance.

