

Trouble Shooting

- 1) No lights on - Please make sure the batteries are installed correctly or try new batteries.
- 2) No response from sensor - The lid may have been closed by hand in manual mode. Pressing "CLOSE" will reset the modes.

Important Safety Instructions

- This appliance is intended for household / commercial use only, and should not be used for any other purpose. Any other use may invalidate the warranty and might be dangerous.
- This appliance is not intended for use by persons (including children) with reduced physical, sensory or mental capabilities, or lack of experience and knowledge, unless they have been given supervision or instructions concerning use of the appliance by a person responsible for their safety.
- This product contains electronic parts inside the lid, do not dip the lid into water or use corrosive liquid to clean the product. Use dry cloth to clean the operation indicator of the lid, use a soft damp cloth to clean the body and liner (rim), wipe dry with a clean cloth.
- Children should be supervised to ensure that they do not play with the appliance.

BATTERY INSTRUCTIONS

- 1) Only adults should handle batteries.
- 2) Always purchase the correct size and grade of battery most suitable for the intended use.
- 3) Always replace the whole set of batteries at one time, taking care not to mix old and new ones, or batteries of different types.
- 4) Risk of explosion if battery is replaced by an incorrect type
- 5) Clean the battery contacts and also those of the device prior to battery installation.
- 6) Ensure the batteries are installed correctly with regard to polarity (+ and -).
- 7) Remove batteries from equipment which is not to be used for an extended period of time.
- 8) Remove used batteries promptly.
- 9) For recycling and disposal of batteries to protect the environment, please check the internet or your local phone directory for local recycling centers and / or follow local government regulations.

* We apologize for any inconvenience caused by minor inconsistencies in these instructions, which may occur as a result of product improvement and development.

EK9278 SENSOR TRASH BIN USE INSTRUCTIONS

Suitable for 20L/30L/45L/20L+20L

V2.2



RoHS
COMPLIANT



Parts List

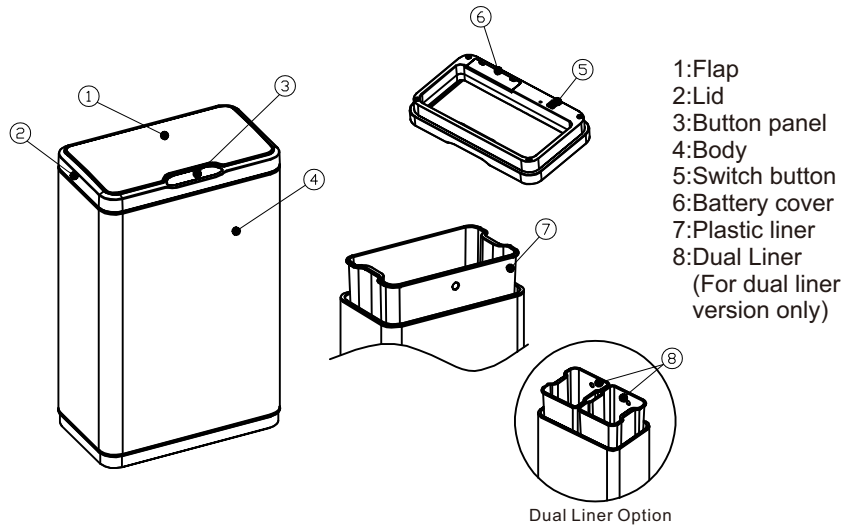

Functions

Effective range:

This product will sense when an object passes through the sensors range, which is about 7.87in/20cm (± 1.97 in/5cm) above the panel.

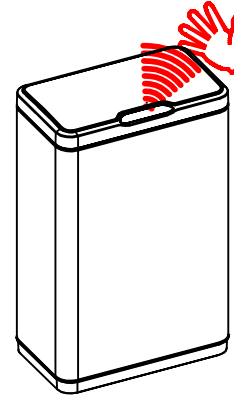

Modes:

Stand-by mode – The lid stays closed and the bin is waiting for a signal to open. A red light flashes to indicate this mode.

Sensor mode – When the sensor unit spots the signal, the lid will open. The lid will stay open as long as the signal stays in the effective range. After the object is removed from the range, the lid will close in 5 seconds.

Manual mode – Users can open the lid by pressing the "OPEN" button. The lid will stay open until the "CLOSE" button is pressed. During this mode, a red light in the middle will flash.

Battery Installation

1) Open the battery cover and take out old batteries(if there is any)

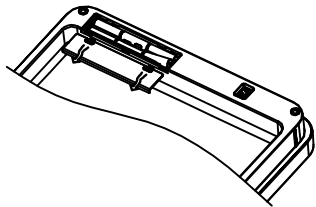

2) Install the batteries into battery box, please mind the polarity (6 x AA - not included)

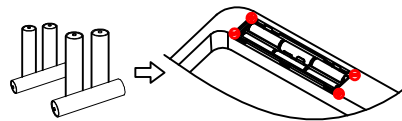

3) Push battery cover to close position, make sure the clip snap firmly

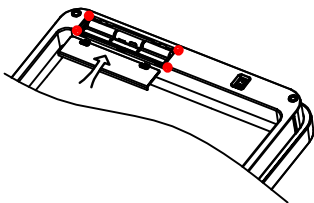

4) Turn on the switch button

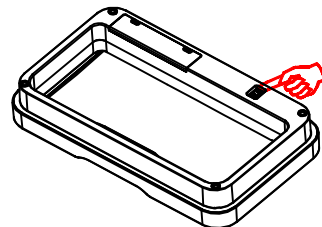

Lighting Indications

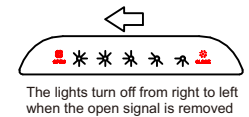
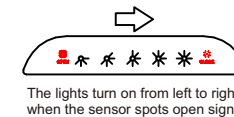
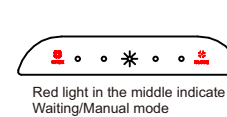

Fixing the Trash Bag

1) wrap the top rim of the liner with plastic bag (please leave the handle outside for easy operation);

2) press the excess bag into the bag fixer on the liner.

