

SHARP



User manual

YC-MG02E-S, YC-MS51E-S, YC-MG51E-S, YC-MG81E-S

Microwave Oven

EN

*Product images are for illustration purpose only. Actual product may vary.

EN

**Attention:**

Your product is marked with this symbol.

It means that used electrical and electronic products should not be mixed with general household waste. There is a separate collection system for these products.

A. Information on Disposal for Users (private households)

1. In the European Union

Attention: If you want to dispose of this equipment, please do not use the ordinary dustbin!

Used electrical and electronic equipment must be treated separately and in accordance with legislation that requires proper treatment, recovery and recycling of used electrical and electronic equipment.

Following the implementation by member states, private households within the EU states may return their used electrical and electronic equipment to designated collection facilities free of charge*.

In some countries* your local retailer may also take back your old product free of charge if you purchase a similar new one.

*) Please contact your local authority for further details.

If your used electrical or electronic equipment has batteries or accumulators, please dispose of these separately beforehand according to local requirements.

By disposing of this product correctly you will help ensure that the waste undergoes the necessary treatment, recovery and recycling and thus prevent potential negative effects on the environment and human health which could otherwise arise due to inappropriate waste handling.

2. In other Countries outside the EU

If you wish to discard this product, please contact your local authorities and ask for the correct method of disposal.

For Switzerland: Used electrical or electronic equipment can be returned free of charge to the dealer, even if you don't purchase a new product. Further collection facilities are listed on the homepage of www.swico.ch or www.sens.ch.

B. Information on Disposal for Business Users

1. In the European Union

If the product is used for business purposes and you want to discard it:

Please contact your SHARP dealer who will inform you about the take-back of the product. You might be charged for the costs arising from take-back and recycling. Small products (and small amounts) might be taken back by your local collection facilities.

For Spain: Please contact the established collection system or your local authority for take-back of your used products.

2. In other Countries outside the EU

If you wish to discard of this product, please contact your local authorities and ask for the correct method of disposal.



CONTENTS

Operation manual

INFORMATION ON PROPER DISPOSAL	1
CONTENTS	2
SPECIFICATIONS	2
OVEN AND ACCESSORIES	3
CONTROL PANEL	4
IMPORTANT SAFETY INSTRUCTIONS	5-15
INSTALLATION	16
BEFORE OPERATION	18
SETTING THE CLOCK	18
MICROWAVE POWER LEVEL	18
MANUAL OPERATION	19
MICROWAVE COOKING	19
GRILL COOKING/ MIX GRILL COOKING	20
OTHER CONVENIENT FUNCTIONS	21
TIME DEFROST AND WEIGHT DEFROST OPERATION	22
AUTO MENU OPERATION	22
AUTO MENU CHART	23
SUITABLE OVENWARE	24
CARE AND CLEANING	25



SPECIFICATIONS

Model name:	YC-MG02E-S	YC-M551E-S	YC-MG51E-S	YC-MG81E-S
AC Line Voltage	: 230 V, 50 Hz single phase	: 230 V, 50 Hz single phase	: 230 V, 50 Hz single phase	: 230 V, 50 Hz single phase
Distribution line fuse/circuit breaker	: 10 A	: 10 A	: 10 A	: 10 A
AC Power required: Microwave	: 1270 W	: 1450 W	: 1450 W	: 1450 W
Output power: Microwave	: 800 W	: 900 W	: 900 W	: 900 W
Grill	: 1000 W		: 1000 W	: 1100 W
Standby	: < 1,0W	: < 1,0W	: < 1,0W	: < 1,0W
Energy Save Mode	: < 0,5W	: < 0,5W	: < 0,5W	: < 0,5W
Microwave Frequency	: 2450 MHz*	: 2450 MHz*	: 2450 MHz*	: 2450 MHz*
Outside Dimensions (W) x (H) x (D) mm	: 440 x 258 x 324	: 513 x 306 x 394	: 513x 306 x 394	: 512 x 300 x 396
Cavity Dimensions (W) x (H) x (D)** mm	: 306 x 205 x 304	: 328 x 206 x 368	: 328 x 206 x 368	: 348 x 226 x 356
Oven Capacity	: 20 litres**	: 25 litres**	: 25 litres**	: 28 litres**
Turntable	: ø 255 mm	: ø 315 mm	: ø 315 mm	: ø 315 mm
Weight	: approx. 11,5 kg	: approx. 14,5 kg	: approx. 15,4 kg	: approx. 15,8 kg
Oven lamp	: 25 W	: 25 W	: 25 W	: 25 W

* This Product fulfils the requirement of the European standard EN55011.

In conformity with this standard, this product is classified as group 2 class B equipment.

Group 2 means that the equipment intentionally generates radio-frequency energy in the form of electromagnetic radiation for the heat treatment of food.

Class B equipment means that the equipment is suitable to be used in domestic establishments.

** Internal capacity is calculated by measuring maximum width, depth and height. Actual capacity for holding food is less.

AS PART OF A POLICY OF CONTINUOUS IMPROVEMENT, WE RESERVE THE RIGHT TO ALTER DESIGN AND SPECIFICATIONS WITHOUT NOTICE.

OVEN AND ACCESSORIES

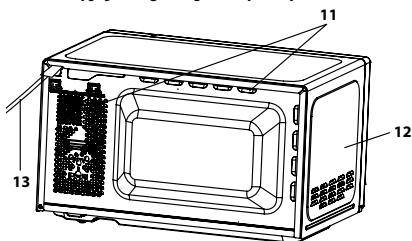
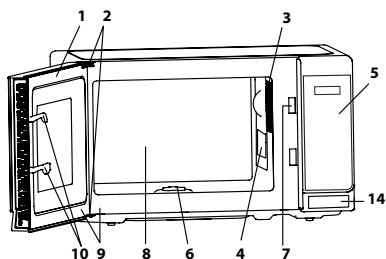

Hub (inside)

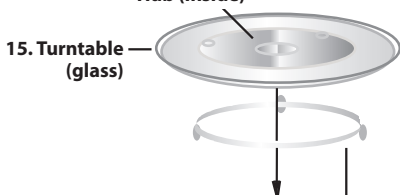
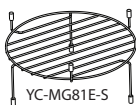
15. Turntable
(glass)17. Coupling — 16. Turntable
support

YC-MG81E-S

YC-MG02E-S,
YC-MG51E-S

18. Rack*

OVEN

1. Door
2. Door hinges
3. Oven lamp
4. Waveguide cover (DO NOT REMOVE)
5. Control panel
6. Coupling
7. Door latches
8. Oven cavity
9. Door seals and sealing surfaces
10. Door safety latches
11. Ventilation openings
12. Outer cabinet
13. Power supply cord
14. Door opening button

ACCESSORIES:

Check to make sure the following accessories are provided:

(15) Turntable (16) Turntable support (17) Coupling (18) Rack*

- Place the turntable support in the centre of the oven floor so that it can freely rotate around the coupling. Then place the turntable on to the turntable support so that it locates firmly into the coupling.
 - To avoid turntable damage, ensure dishes and containers are lifted clear of the turntable rim when removing them from the oven.
- For use of the rack, refer to the grilling sections on page EN-20.

Never touch the grill when it is hot.

NOTE: When you order accessories, please mention two items: part name and model name.

NOTES:

- The waveguide cover is fragile. Care should be taken when cleaning inside the oven to ensure that it is not damaged.
- After cooking fatty foods without a cover, always clean the cavity and especially the grill heating element thoroughly, these must be dry and free from grease. Built-up grease may overheat and begin to smoke or catch fire.
- Always operate the oven with the turntable and turntable support fitted correctly. This promotes thorough, even cooking. A badly fitted turntable may rattle, may not rotate properly and could cause damage to the oven.
- All food and containers of food are always placed on the turntable for cooking.
- The turntable rotates clockwise or anti-clockwise. The rotary direction may change each time you start the oven. This does not affect cooking performance.

⚠ WARNING: ⚠ This symbol means that the surfaces are liable to get hot during use. The door, outer cabinet, oven cavity, accessories and dishes will become very hot during operation. To prevent burns, always use thick oven gloves.

* - Only for models with Grill.



CONTROL PANEL

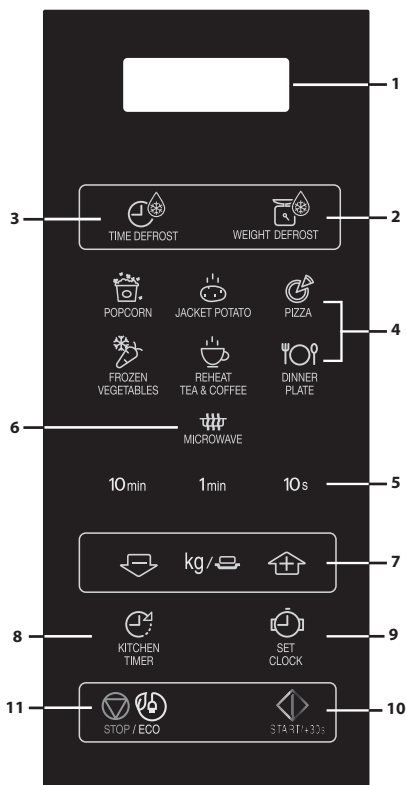

microwave solo

1. **DIGITAL DISPLAY**
2. **WEIGHT DEFROST key**
3. **TIME DEFROST key**
4. **AUTO MENU keys**
5. **TIME keys**
6. **MICROWAVE POWER LEVEL key:**
Press to select microwave power level.
7. **WEIGHT/PORTION keys (up and down)**
8. **KITCHEN TIMER key**
Press to use as a minute timer, or to programme standing time.
9. **CLOCK SET key**
10. **START / \blacktriangleleft + 30s**
11. **STOP/ECO key**

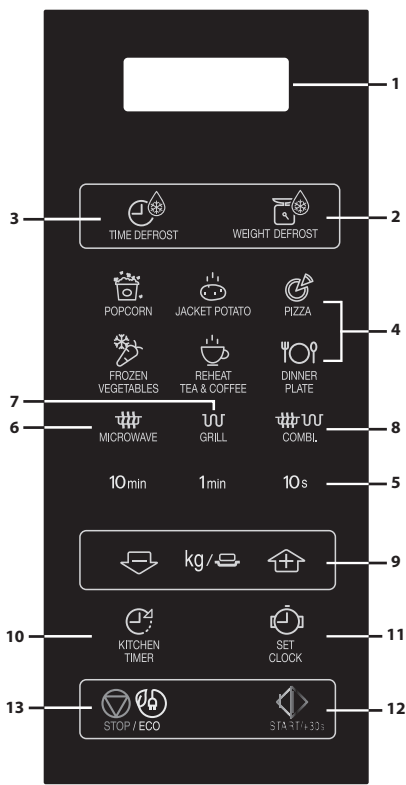

microwave + grill

1. **DIGITAL DISPLAY**
2. **WEIGHT DEFROST key**
3. **TIME DEFROST key**
4. **AUTO MENU keys**
5. **TIME keys**
6. **MICROWAVE POWER LEVEL key:**
Press to select microwave power level.
7. **Grill key**
8. **Mix Grill key**
9. **WEIGHT/PORTION keys (up and down)**
10. **KITCHEN TIMER key**
Press to use as a minute timer, or to programme standing time.
11. **CLOCK SET key**
12. **START / \blacktriangleleft + 30s**
13. **STOP/ECO key**

IMPORTANT SAFETY INSTRUCTIONS



IMPORTANT SAFETY INSTRUCTIONS: READ CAREFULLY AND KEEP FOR FUTURE REFERENCE

To avoid the danger of fire.

The microwave oven should not be left unattended during operation. Power levels that are too high, or cooking times that are too long, may overheat foods resulting in a fire.

This oven is designed to be used on a countertop only. It is not designed to be built into a kitchen unit.

Do not place the oven in a cabinet.

The electrical outlet must be readily accessible so that the unit can be unplugged easily in an emergency.

The AC power supply must be 230 V, 50 Hz, with a minimum 10 A distribution line fuse, or a minimum 10 A distribution circuit breaker.

A separate circuit serving only this appliance should be provided.

Do not place the oven in areas where heat is generated. For example, close to a conventional oven.

Do not install the oven in an area of high humidity or where moisture may collect.

Do not store or use the oven outdoors.



IMPORTANT SAFETY INSTRUCTIONS

If smoke is observed, switch off or unplug the oven and keep the door closed in order to stifle any flames.

Use only microwave-safe containers and utensils. See Page EN-24. Utensils should be checked to ensure that they are suitable for use in microwave ovens.

When heating food in plastic or paper containers, keep an eye on the oven due to the possibility of ignition.

Clean the waveguide cover, the oven cavity, the turntable and turntable support after use. These must be dry and free from grease. Built-up grease may overheat and begin to smoke or catch fire.

Do not place flammable materials near the oven or ventilation openings.

Do not block the ventilation openings.

Remove all metallic seals, wire twists, etc., from food and food packages. Arcing on metallic surfaces may cause a fire.

Do not use the microwave oven to heat oil for deep frying. The temperature cannot be controlled and the oil may catch fire.

To make popcorn, use only special microwave popcorn makers.

Do not store food or any other items inside the oven. Check the settings after you start the oven to ensure the oven is operating as desired.

IMPORTANT SAFETY INSTRUCTIONS



To avoid overheating and fire, special care must be taken when cooking or reheating foods with a high sugar or fat content, for example, Sausage rolls, Pies or Christmas pudding.

See the corresponding hints in the operation manual.

To avoid the possibility of injury

WARNING:

Do not operate the oven if it is damaged or malfunctioning. Check the following before use:

- a) Make sure the door closes properly and ensure it is not misaligned or warped.
- b) Check to make sure the hinges and safety door latches are not broken or loose.
- c) Ensure that the door seals and sealing surfaces have not been damaged. Inside the oven cavity or on the door; make sure there are no dents.
- d) Make sure inside the oven cavity or on the door are no dents.
- e) Ensure that the power supply cord and plug are not damaged.

If the door or door seals are damaged, the oven must not be operated until it has been repaired by a competent person.

Never adjust, repair or modify the oven yourself. It is hazardous for anyone other than a competent person to carry out any service or repair operation which involves the removal of a cover which gives protection against exposure to microwave energy.



IMPORTANT SAFETY INSTRUCTIONS

Do not operate the oven with the door open or alter the door safety latches in any way. Do not operate the oven if there is an object between the door seals and sealing surfaces.

Do not allow grease or dirt to build up on the door seals and adjacent parts. Clean the oven at regular intervals and remove any food deposits. Follow the instructions for "Care and Cleaning" on page EN-25. Failure to maintain the oven in a clean condition could lead to a deterioration of the surface that could adversely affect the life of the appliance and possibly result in a hazardous situation.

Individuals with PACEMAKERS should check with their doctor or the manufacturer of the pacemaker for precautions regarding microwave ovens.

To avoid the possibility of electric shock

Under no circumstances should you remove the outer cabinet.

Never spill or insert any objects into the door lock openings or ventilation openings. In the event of a spill, turn off and unplug the oven immediately, and call an authorised SHARP service agent.

Do not immerse the power supply cord or plug in water or any other liquid.

Do not let the power supply cord hang over the edge of a table or work surface.

IMPORTANT SAFETY INSTRUCTIONS



Keep the power supply cord away from heated surfaces, including the rear of the oven.

Keep the appliance and its cord out of reach of children less than 8 years.

Do not attempt to replace the oven lamp yourself or allow anyone who is not an electrician authorised by SHARP to do so. If the oven lamp fails, please consult your dealer or an authorised SHARP service agent.

If the power supply cord of this appliance is damaged, it must be replaced with a special cord.

The exchange must be made by qualified persons in order to avoid a hazard.

To avoid the possibility of explosion and sudden boiling:

WARNING: Liquids and other foods must not be heated in sealed containers since they are liable to explode.

Microwave heating of beverages can result in delayed eruptive boiling, therefore care must be taken when handling the container.

Never use sealed containers. Remove seals and lids before use. Sealed containers can explode due to a build up of pressure even after the oven has been turned off.

Take care when microwaving liquids. Use a wide mouthed container to allow bubbles to escape.



IMPORTANT SAFETY INSTRUCTIONS

Never heat liquids in narrow necked containers such as baby bottles, as this may result in the contents erupting from the container when heated and cause burns.

To prevent sudden eruption of boiling liquid and possible scalding:

1. Do not use excessive amount of time.
2. Stir liquid prior to heating/reheating.
3. It is advisable to insert a glass rod or similar utensil (not metal) into the liquid whilst reheating.
4. Let liquid stand for at least 20 seconds in the oven at the end of cooking time to prevent delayed eruptive boiling.

Do not cook eggs in their shells, and whole hard boiled eggs should not be heated in microwave ovens since they may explode even after microwave cooking has ended. To cook or reheat eggs which have not been scrambled or mixed, pierce the yolks and the whites, or the eggs may explode. Shell and slice hard boiled eggs before reheating them in the microwave oven.

Pierce the skin of such foods as potatoes, sausages and fruit before cooking, or they may explode.

IMPORTANT SAFETY INSTRUCTIONS



To avoid the possibility of burns

WARNING: The contents of feeding bottles and baby food jars must be stirred or shaken and the temperature checked before consumption, in order to avoid burns.

Use pot holders or oven gloves when removing food from the oven to prevent burns.

Always open containers, popcorn makers, oven cooking bags, etc., away from the face and hands to avoid steam burns and eruption of boiling.

To avoid burns, always test food temperature and stir before serving and pay special attention to the temperature of food and drink given to babies, children or the elderly. Accessible parts may become hot during use. Young children should be kept away. Temperature of the container is not a true indication of the temperature of the food or drink; always check the food temperature.

Always stand back from the oven door when opening it to avoid burns from escaping steam and heat.

Slice stuffed baked foods after heating to release steam and avoid burns.

Keep children away from the door to prevent them burning themselves.



IMPORTANT SAFETY INSTRUCTIONS

To avoid misuse by children

WARNING: Only allow children aged from 8 years and above to use the oven without supervision when adequate instructions have been given so that the child is able to use the oven in a safe way and understands the hazards of improper use. When the appliance is operated in the GRILL, MIX GRILL and AUTO MENU operation, children should only use the oven under adult supervision due to the temperature generated. This appliance is not intended for use by persons (including children) with reduced physical, sensory or mental capabilities, or lack of experience and knowledge, unless they have been given supervision or instruction concerning use of the appliance by a person responsible for their safety. Children should be supervised to ensure that they do not play with the appliance. This oven is enabled with a child lock mode, refer to page EN-21 for more details.

Do not lean or swing on the oven door. Do not play with the oven or use it as a toy.

Children should be taught all important safety instructions: use of pot holders, careful removal of food coverings; paying special attention to packaging (e.g. self-heating materials) designed to make food crisp, as they may be extra hot.

IMPORTANT SAFETY INSTRUCTIONS



Other warnings

Never modify the oven in any way.

Do not move the oven while it is in operation.

This appliance is intended to be used in household and similar applications such as:

- staff kitchen areas in shops, offices and other working environments;
- farm houses;
- by clients in hotels, motels and other residential environments;
- bed and breakfast type environments.

This oven is for home food preparation only and may only be used for cooking food. It is not suitable for commercial or laboratory use.

To promote trouble-free use of your oven and avoid damage.

Never operate the oven when it is empty. When using a browning dish or self-heating material, always place a heat-resistant insulator such as a porcelain plate under it to prevent damage to the turntable and turntable support due to heat stress. The preheating time specified in the dishes instructions must not be exceeded.



IMPORTANT SAFETY INSTRUCTIONS

Do not use metal utensils, which reflect microwaves and may cause electrical arcing. Do not put cans in the oven.

Use only the turntable and the turntable support designed for this oven. Do not operate the oven without the turntable.

To prevent the turntable from breaking:

- (a) Before cleaning the turntable with water, leave the turntable to cool.
- (b) Do not put hot foods or hot utensils on a cold turntable.
- (c) Do not put cold foods or cold utensils on a hot turntable.

Do not place anything on the outer cabinet during operation.

IMPORTANT SAFETY INSTRUCTIONS



NOTE:

Do not use plastic containers for microwaving if the oven is still hot from using the GRILL and MIX GRILL operation because they may melt.

Plastic containers must not be used during above modes unless the container manufacturer says they are suitable.

If you are unsure how to connect your oven, please consult an authorised, qualified electrician.

Neither the manufacturer nor the dealer can accept any liability for damage to the oven or personal injury resulting from failure to observe the correct electrical connection procedure.

Water vapour or drops may occasionally form on the oven walls or around the door seals and sealing surfaces. This is a normal occurrence and is not an indication of microwave leakage or a malfunction.



This symbol means that the surfaces are liable to get hot during use.



INSTALLATION

1. Remove all packing materials from the inside of the oven cavity and remove any protective film found on the microwave oven cabinet surface.
2. Check the oven carefully for any signs of damage.
3. Place the oven on a secure, level surface, strong enough to take the oven weight, plus the heaviest item likely to be cooked in the oven. Do not place the oven in a cabinet.
4. Select a level surface that provide enough open space for the intake and/or outlet vents. The rear surface of appliance can be placed against a wall.
 - The minimum installation height is 85 cm.
 - A minimum space of 20cm is required between the sides of the microwave oven and any adjacent walls or objects.
 - Leave a minimum space of 30 cm above the oven.
 - Do not remove the feet from the bottom of the oven.
 - Blocking the intake and/or outlet openings can damage the oven.
 - Place the oven as far away from radios and TV as possible. Operation of microwave oven may cause interference to your radio or TV reception.

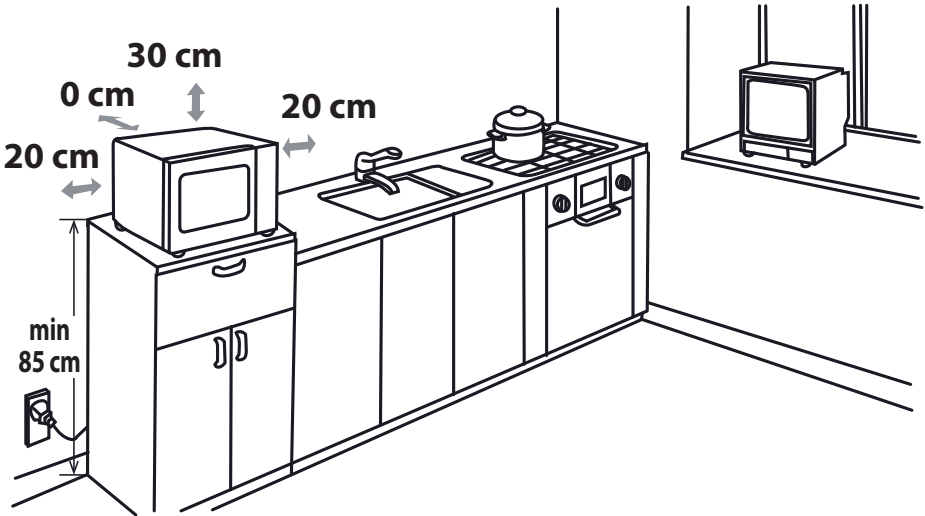

5. Securely connect the plug of the oven to a standard earthed (grounded) household electrical outlet.

WARNING: Do not place the oven where heat, moisture or high humidity are generated, (for example, near or above a conventional oven) or near combustible materials (for example, curtains).

Do not block or obstruct air vent openings.

Do not place objects on top of the oven.

Do not touch the exterior of the microwave oven during or shortly after operation as it will be hot.



BEFORE OPERATION



Plug in the oven. The oven display will display: "0:00", an audible signal will sound once.

This model has a clock function and the oven uses less than 1.0 W in stand by mode. To set the clock, see below.



SETTING THE CLOCK

Your oven has a 24 hour clock mode.

1. Press the **CLOCK SET** key  once and "00:00" will flash.
2. Press the time keys and enter the current time. Enter the hours by pressing the **10 min** key and enter the minutes by pressing the **1 min** and **10 s** keys.
3. Press the **CLOCK SET** key  to finish clock setting.

NOTES:

- If the clock is set, when cooking is complete, the display will show the correct time of day. If the clock has not been set, the display will only show "0:00" when cooking is complete.
- To check the time of day during a cooking process, press **CLOCK SET** key and the LED will display the time of day for 2-3 seconds. This does not affect the cooking process.
- While in the clock setting mode, if the **STOP** key is pressed or if there is no operation within 1 minute, the oven will go back to the former setting.
- If the electrical power supply to your microwave oven is interrupted, the display will intermittently show "0:00" after the power is reinstated. If this occurs during cooking, the programme will be erased. The time of day will also be erased.



MICROWAVE POWER LEVEL

Power Level	Press the MICROWAVE POWER LEVEL key 	Display (Percentage)
HIGH	x1	100P
	x2	90P
MEDIUM HIGH	x3	80P
	x4	70P
MEDIUM	x5	60P
	x6	50P
MEDIUM LOW (DEFROST)	x7	40P
	x8	30P
LOW	x9	20P
	x10	10P
	x11	0P

- Your oven has 11 power levels, as shown.
- To change the power level for cooking, press the **MICROWAVE POWER LEVEL** key until the display indicates the desired level. Set up the desired cooking time by pressing TIME keys. Press the **START** key to start the oven.
- To check the power level during cooking, press the **MICROWAVE POWER LEVEL** key. As long as your finger is pressing the **MICROWAVE POWER LEVEL** key the power level will be displayed. The oven continues to count down although the display will show the power level.
- If "0P" is selected, the oven will work with fan for no power. You can use this level to remove any odours.

Generally the following recommendations apply:

100P/ 90P - (HIGH) used for fast cooking or reheating e.g. for casseroles, hot beverages, vegetables etc.

80P/ 70P - (MEDIUM HIGH) used for longer cooking of dense foods such as roast joints, meat loaf and plated meals, also for sensitive dishes such as sponge cakes. At this reduced setting, the food will cook evenly without over cooking at the sides.

60P/ 50P - (MEDIUM) for dense foods which require a long cooking time when cooked conventionally, e.g.

beef casserole, it is advisable to use this power setting to ensure the meat will be tender.

40P/ 30P - (MEDIUM LOW) to defrost, select this power setting, to ensure that the dish defrosts evenly. This setting is also ideal for simmering rice, pasta, dumplings and cooking egg custard.

20P/ 10P - (LOW) For gentle defrosting, e.g. cream, gateaux, or pastry.

MANUAL OPERATION



Opening the door:

To open the oven door, press door opening button.

Starting the oven:

Prepare and place food in a suitable container onto the turntable or place directly onto the turntable. Close the door and press the **START/◊+30s** key after selecting the desired cooking mode. You may extend the desired cooking time during manual cooking by pressing **TIME keys** or **START/◊+30s key**.

Once the cooking programme has been set and the **START/◊+30s** key is not pressed in 1 minute, the setting will be cancelled.

The **START/◊+30s** key must be pressed to continue cooking if the door is opened during cooking. The audible signal will sound once when the button is pressed in the correct manner.

Use the **STOP** key to:

1. Erase a mistake during programming.
2. Stop the oven temporarily during cooking.
3. Cancel a programme during cooking, press the **STOP** key twice.
4. To set and to cancel the child lock (refer to page EN-21).



START+30s



STOP / ECO

MICROWAVE COOKING



Your oven can be programmed for up 99 minutes 50 seconds (99.50).

MANUAL COOKING/ MANUAL DEFROSTING

- Enter the cooking time and use microwave power levels 100P to 10P to cook or defrost (refer to page EN-18).
- Stir or turn the food, where possible, 2 - 3 times during cooking.
- After cooking, cover the food and leave to stand, where recommended.
- After defrosting, cover the food in foil and leave to stand until thoroughly defrosted.

Example:

To cook 2 minutes and 30 seconds on 70% microwave power.

1. Input the power level by pressing the **MICROWAVE POWER LEVEL** key 4 times for 70 P.
2. Enter the cooking time by pressing the **1 min** key twice and then the **10 s** key 3 times.
3. Press the **START/◊+30s** key to start the timer. (The display will count down through the set cooking/defrosting time.)



NOTE:

- When the oven starts, the oven lamp will light and the turntable will rotate clockwise or anticlockwise.
- If the door is opened during cooking/defrosting to stir or turn over food, the cooking time on the display stops automatically. The cooking/ defrosting time starts to count down again when the door is closed and the **START** key is pressed.
- When cooking/defrosting is complete, open the door or press **STOP** key and the time of day will reappear on the display, if the clock has been set.
- If you wish to know the power level during cooking, press the **MICROWAVE POWER LEVEL** key. As long as your finger is pressing the **MICROWAVE POWER LEVEL** key, the power level will be displayed.

IMPORTANT:

- Close the door after cooking / defrosting. Please note that the light will remain on when the door is open, this is for safety reason to remind you to close the door.
- If you cook food for more than the standard time (see chart below) using the same cooking mode, the oven's safety mechanisms automatically activate. The microwave power level will be reduced or the grill heating element will turn on and off.

Cooking Mode	Standard time
Microwave 100 P	30 minutes
Grill cooking*	Intermittent operation, temperature controlled
Mix grill cooking*	99 mins 50 sec

*- Only for models with Grill



GRILL COOKING/MIX GRILL COOKING*

1. GRILL ONLY COOKING

The grill at the top of the oven cavity has one power setting only. The grill is assisted by the turntable which rotates simultaneously to ensure even browning. Use the rack for grilling small items of food such as bacon, gammon and teacakes. Food can be placed either directly onto the rack, or into a flan dish/heat-resistant plate on the rack.

Example:

To grill for 20 minutes, using **GRILL** key.

1. Press **GRILL** key once.



G

2. Enter the required heating time by pressing the **10 min** key twice.

20:00

3. Press the **START/⟳+30s** key to start the grilling. (The display will count down through the set grilling time.)

20:00

2. MIX GRILL COOKING

MIX GRILL combines microwave power with the grill. MIX means to cook by Microwave power and Grill power alternately.

The combination of microwave power with the grill reduces cooking time and provides a crisp, brown finish. There are 2 choices for the combination:

COMBINATION 1 (Display: C-1)

55% time for microwave power, 45% time for grill cooking. Use for fish and au gratin.

COMBINATION 2 (Display: C-2)

36% time for microwave cooking, 64% time for grill cooking. Use for pudding omelets, and poultry.

Example:

To cook for 15 minutes, using **MIX GRILL** with 55% time microwave power and 45% grill power (C-1).

1. Press **MIX GRILL** key once.



C-1

2. Enter the required heating time by pressing the **10 min** key once and the **1 min** key 5 times.

15:00

3. Press the **START/⟳+30s** key to start the cooking. (The display will count down through the set cooking time.)

15:00

NOTES for GRILL and MIX GRILL COOKING:

- It is not necessary to preheat the grill.
- When browning foods in a deep container, place on the turntable.
- You may detect smoke or a burning smell when using the grill for the first time. This is normal and not a sign that the oven is faulty. To avoid this problem, when first using the oven, heat the oven without food for 20 minutes on grill.

IMPORTANT: During operation, to allow smoke or smells to disperse open a window or switch the kitchen ventilation on.

⚠ WARNING:

The door, outer cabinet, oven cavity and accessories will become very hot during operation. To prevent burns, always use thick oven gloves.

* - Only for models with Grill.

OTHER CONVENIENT FUNCTIONS



1. SEQUENCE COOKING

This function allows you to cook using up to 2 different stages which can include manual cooking time and mode and /or time defrost as well as weight defrost function. Once programmed there is no need to interfere with the cooking operation as the oven will automatically move onto the next stage. The audible signal will sound once after the first stage. If defrosting is required, this should always be the first stage.

Note: Auto menu cannot be set as one of the multiple sequences.

Example: If you want to defrost the food for 5 minutes, then to cook with 80P microwave power for 7 minutes. The steps are as follows:

1. Press the **TIME DEFROST** key once, in the LED display will appear dEF2.
2. Enter the cooking time by pressing the **1 min** key 5 times.
3. Input the power level (80P) by pressing the **MICROWAVE POWER LEVEL** key 3 times.
4. Enter the cooking time by pressing the **1 min** key 7 times.
5. Press the **START** key once to start cooking.

2. +30s FUNCTION (Auto-start)

The +30s key allows you to operate the two following functions:



a. Direct start

You can directly start cooking on 100 P microwave power level for 30 seconds by pressing the **+30s** key.

b. Extend the cooking time

You can extend the cooking time during manual cooking, time defrost and auto menu operation for multiples of 30 second if the **+30s** key is pressed while the oven is in operation. You may extend the desired cooking time also by pressing TIME keys "10min", "1min", "10s". During the weight defrost, the cooking time cannot be increased.



NOTE: The cooking time may be extended to a maximum of 99 minutes 50 seconds.

3. KITCHEN TIMER FUNCTION :

You can use the kitchen timer for timing where microwave cooking is not involved for example to time boiled eggs cooked on conventional hob or to monitor the standing time for cooked/defrosted food.

Example:

To set the timer for 5 minutes.

1. Press the **KITCHEN TIMER** key once. 
2. Enter the desired time by pressing the **1 min** key 5 times.
3. Press the **START**  **+30s** key to start the timer. **Check the display.** (The display will count down through the set cooking/defrosting time.)

When the timer time arrives, the audible signal will sound 5 times and the LED will display then time of day. You can enter any time up to 99 minutes, 50 seconds. To cancel the KITCHEN TIMER whilst counting down, simply press the **STOP** key.

NOTE: The KITCHEN TIMER function cannot be used whilst cooking.

4. CHILD LOCK:

Use to prevent unsupervised operation of the oven by little children.

a. To set the CHILD LOCK:

Press and hold the **STOP** key for 3 seconds until a long a beep sound. The display will show:



b. To cancel the CHILD LOCK:

Press and hold the **STOP** key for 3 seconds until a long beep sound.

5. ECO MODE:

In standby mode, press the "ECO" button once, the LED display will be off and microwave oven enter to ECO mode, any operation can light the LED display again, and the microwave oven will return to standby mode.





TIME DEFROST AND WEIGHT DEFROST OPERATION

1. TIME DEFROST

This function quickly defrosts food while enabling you to choose a suitable defrost period, depending on the food type. Follow the example below for details on how to operate this function. The time range is 0:10 – 99:50.

Example: To defrost the food for 10 minutes.

1. Select the menu required by pressing the **TIME DEFROST** key once.
2. Enter the cooking time by pressing the **10 min** key once.
3. Press the **START/◀** **+30s** key to start defrosting.



the display will show:

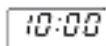

Notes for Time Defrost:

- After cooking the audible signal will sound five times and the LED will display then time of day, if the clock has been set. If the clock has not been set, the display will only show "0:00" when cooking is complete.
- The preset microwave power level is 30P and can not be changed.

2. WEIGHT DEFROST

The microwave oven is pre-programmed with a time and power level so that the following food is defrosted easily: Pork, beef and chicken. The weight range for this food is from 0.1kg – 2kg in 0.1kg steps.

Follow the example below for details on how to operate these functions.

Example: To defrost a Meat joint weighing 1.2kg using WEIGHT DEFROST.

Place the meat in a flat dish or microwave oven defrost rack on the turntable.

1. Select the menu required by pressing the **WEIGHT DEFROST** key once.
2. Enter the weight by pressing the **WEIGHT/PORTION** keys until the desired weight is displayed
3. Press the **START/◀** **+30s** key to start defrosting. (The display will count down through defrosting time)



the display will show:

kg/⊞  display:

Frozen foods are defrosted from -18°C.

NOTES FOR WEIGHT DEFROST:

- Before freezing foods, ensure food is fresh and of good quality.
- Food weight should be rounded up to the nearest 0.1kg, for example, 0.65kg to 0.7kg.
- If necessary, shield small areas of meat or poultry with flat pieces of aluminium foil. This will prevent the areas from becoming warm during defrosting. Ensure the foil does not touch the oven walls.



AUTO MENU OPERATION

The **AUTO MENU** keys automatically work out the correct cooking mode and cooking of the foods (details on page EN-4 and EN-23). Follow the example below for details on how to operate this function.

Example: To cook two jacket potatoes (0.46kg) by using the AUTO MENU function.

1. Select the required menu by pressing the **Jacket Potato** key once.
2. Press **WEIGHT/PORTION UP/DOWN** keys or continue to press the **Jacket Potato** key to choose the required number of potatoes (up to 3).
3. Press the **START/◀** **+30s** key to start cooking. (The display will count down through cooking time)



the display will show:

kg/⊞  x1, display:

NOTES:

- The weight or quantity of the food can be input by pressing the WEIGHT/PORTION UP/DOWN keys until the desired weight/quantity is displayed. Enter the weight of the food only. Do not include the weight of the container.
- For food weighing more or less than the weights/quantities given in the AUTO MENU chart on page EN-23 cook by manual operation.

AUTO MENU CHART



Auto Menu	WEIGHT/ PORTION / UTENSILS	Procedure
Popcorn	0.05kg, 0.1kg	Place the popcorn bag directly on the turntable (Please see the note below: 'Important Information About Microwave Popcorn Feature')
Jacket Potato	1, 2, 3 potatoes (pieces) 1 potato = approx. 0.23kg (initial temp. 20° C)	Please use potatoes with a similar size of approx. 230g. Pierce each potato in several places and place towards the edge of the turntable. Turn over and re-arrange halfway through cooking. Stand for 3 - 5 minutes before serving.
Pizza	0.1kg, 0.2kg, 0.4kg (initial temp 5°C) Plate	Place the Pizza on a plate in the centre of the turntable. Do not cover.
Frozen vegetable e.g. Brussel sprouts, green beans, peas, mixed vegetables, broccoli	0.15kg, 0.35kg, 0.5kg (initial temp -18°C) Bowl and lid	Place vegetables in a suitable container. Add 1tbsp of water per 100g of vegetables, cover the dish and place on the turntable. Stir halfway through cooking and after cooking.
Reheat Tea & Coffee (120ml/ cup)	1, 2, 3 (initial temp. 5° C) Cup	Place the cup(s) on the turntable and stir after heating.
Dinner Plate	0.25kg, 0.35kg, 0.5kg (initial temp. 5° C) Plate	Place the plate in the centre of the turntable. Do not cover. Stir after cooking.

Notes:

- The final temperature will vary according to the initial food temperature. Check food is piping hot after cooking. If necessary, you can extend the cooking manually.
- The results when using auto cook depend on variances such as the shape and size of the food and your personal preference as regards cooking results. If you are not satisfied with the programmed result, please adjust the cooking time to match your requirement.

Important Information about Microwave Popcorn Feature:

1. When selecting 0.1kg grams of popcorn, it is suggested that you fold down a triangle on each corner of the bag before cooking.
Refer to the picture at right.

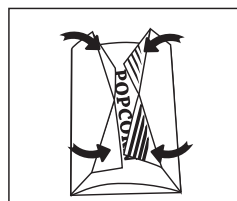

2. If/When the popcorn bag expands and no longer rotates properly, please press STOP key once and open the oven door and adjust the bag position to ensure even cooking.

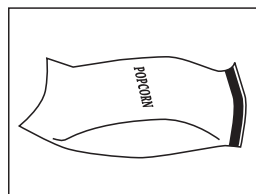



SUITABLE OVENWARE

To cook/defrost food in a microwave oven, the microwave energy must be able to pass through the container to penetrate the food. Therefore it is important to choose suitable cookware.

Round/oval dishes are preferable to square/oblong ones, as the food in the corners tends to overcook. A variety of cookware can be used as listed below.

Cookware	Microwave Safe	Grill	Comments
Aluminium foil Foil Containers	✓ / ✗	✓	Small pieces of aluminium foil can be used to shield food from overheating. Keep foil at least 2cm from the oven walls, as arcing may occur. Foil containers are not recommended unless specified by the manufacturer, e.g. Microfoil [®] , follow instructions carefully.
Browning dishes	✓	✗	Always follow the manufacturers instructions. Do not exceed heating times given. Be very careful as these dishes become very hot.
China and ceramics	✓ / ✗	✗	Porcelain, pottery, glazed earthenware and bone china are usually suitable, except for those with metallic decoration.
Glassware e.g. Pyrex [®]	✓	✓	Care should be taken if using fine glassware as it can break or crack if heated suddenly.
Metal	✗	✓	It is not recommended to use metal cookware as it will arc, which can lead to fire.
Plastic/Polystyrene e.g fast food containers	✓	✗	Care must be taken as some containers warp, melt or discolour at high temperatures.
Cling film	✓	✗	It should not touch the food and must be pierced to let the steam escape.
Freezer/Roasting bags	✓	✗	Must be pierced to let steam escape. Ensure bags are suitable for microwave use.
Paper - Plates, cups and kitchen paper	✓	✗	Do not use plastic or metal ties, as they may melt or catch fire due to the metal 'arcing'.
Straw and wooden Containers	✓	✗	Only use for warming or to absorb moisture. Care must be taken as overheating may cause fire.
Recycled paper and newspaper	✗	✓	Always attend the oven when using these materials as overheating may cause fire. May contain extracts of metal which will cause 'arcing' and may lead to fire.

⚠ WARNING:
When heating food in plastic or paper containers, monitor the oven due to the possibility of ignition.

CARE AND CLEANING



CAUTION: DO NOT USE COMMERCIAL OVEN CLEANERS, STEAM CLEANERS, ABRASIVE, HARSH CLEANERS, ANY THAT CONTAIN SODIUM HYDROXIDE OR SCOURING PADS ON ANY PART OF YOUR MICROWAVE OVEN.

Before cleaning, make sure the oven cavity, door, oven cabinet and accessories are completely cool. CLEAN THE OVEN AT REGULAR INTERVALS AND REMOVE ANY FOOD DEPOSITS - Keep the oven clean, or the oven could lead to a deterioration of the surface. This could adversely affect the life of the appliance and possibly result in a hazardous situation.

Oven exterior

The outside of your oven can be cleaned easily with mild soap and water. Make sure the soap is wiped off with a moist cloth, and dry the exterior with a soft towel.

Control panel

Open the door before cleaning to de-activate the control panel. Care should be taken in cleaning the control panel. Using a cloth dampened with water only, gently wipe the panel until it becomes clean.

Avoid using excessive amounts of water. Do not use any sort of chemical or abrasive cleaner.

Oven Interior

1. For cleaning, wipe any splatters or spills with a soft damp cloth or sponge after each use while the oven is still warm. For heavier spills, use a mild soap and wipe several times with a damp cloth until all residues are

removed. Built-up splashes may overheat and begin to smoke or catch fire, and cause arcing. Do not remove the waveguide cover.

2. Make sure that mild soap or water does not penetrate the small vents in the walls which may cause damage to the oven.

3. Do not use spray type cleaners on the oven interior.

4. (*Grill models only*) Heat up your oven regularly by using the grill and heat the oven without food for 20 minutes on grill (page EN-20). Remaining food or fat splashed can cause smoke or bad smell.

Keep the waveguide cover clean at all times.

The waveguide cover is constructed from a fragile material and should be cleaned with care (follow the cleaning instructions above).

NOTE: Excessive soaking may cause disintegration of the waveguide cover.

The waveguide cover is a consumable part and without regular cleaning, will need to be replaced.

Accessories

The accessories like turntable, turntable support and rack should be washed in a mild washing up liquid solution and dried. They are dishwasher safe.

Door

To remove all trace of dirt, regularly clean both sides of the door, the door seals and adjacent parts with a soft, damp cloth. Do not use abrasive cleaner.

NOTE: A steam cleaner should not be used.

Cleaning tip - For easier cleaning of your oven:

Place half a lemon in a bowl, add 300ml (1/2 pint) water and heat on 100% for 10 -12 minutes.

Wipe the oven clean using a soft, dry cloth.



UMC Poland Sp. z o.o.
Ostaszewo 57B, 87-148 Łysomice, Poland

SHARP CORPORATION
1 Takumi-cho, Sakai-ku
Sakai City, Osaka
590-8522, Japan

SDA/MAN/0024

www.sharpconsumer.eu

SHARP