



marantz[®]

5 Channel Power Amplifier

MM7055

2 Channel Power Amplifier

MM7025

User Guide

SAFETY PRECAUTIONS



CAUTION
RISK OF ELECTRIC SHOCK
DO NOT OPEN



CAUTION:

TO REDUCE THE RISK OF ELECTRIC SHOCK, DO NOT REMOVE COVER (OR BACK). NO USER-SERVICEABLE PARTS INSIDE. REFER SERVICING TO QUALIFIED SERVICE PERSONNEL.



The lightning flash with arrowhead symbol, within an equilateral triangle, is intended to alert the user to the presence of uninsulated "dangerous voltage" within the product's enclosure that may be of sufficient magnitude to constitute a risk of electric shock to persons.



The exclamation point within an equilateral triangle is intended to alert the user to the presence of important operating and maintenance (servicing) instructions in the literature accompanying the appliance.

WARNING:

TO REDUCE THE RISK OF FIRE OR ELECTRIC SHOCK, DO NOT EXPOSE THIS APPLIANCE TO RAIN OR MOISTURE.

IMPOTANT SAFETY INSTRUCTIONS

1. Read these instructions.
2. Keep these instructions.
3. Heed all warnings.
4. Follow all instructions.
5. Do not use this apparatus near water.
6. Clean only with dry cloth.
7. Do not block any ventilation openings. Install in accordance with the manufacturer's instructions.
8. Do not install near any heat sources such as radiators, heat registers, stoves, or other apparatus (including amplifiers) that produce heat.
9. Protect the power cord from being walked on or pinched particularly at plugs, convenience receptacles, and the point where they exit from the apparatus.
10. Only use attachments/accessories specified by the manufacturer.
11. Use only with the cart, stand, tripod, bracket, or table specified by the manufacturer, or sold with the apparatus. When a cart is used, use caution when moving the cart/apparatus combination to avoid injury from tip-over.
12. Unplug this apparatus during lightning storms or when unused for long periods of time.
13. Refer all servicing to qualified service personnel. Servicing is required when the apparatus has been damaged in any way, such as power-supply cord or plug is damaged, liquid has been spilled or objects have fallen into the apparatus, the apparatus has been exposed to rain or moisture, does not operate normally, or has been dropped.
14. Batteries shall not be exposed to excessive heat such as sunshine, fire or the like.



Hot surface mark

CAUTION:

HOT SURFACE. DO NOT TOUCH.

The top surface over the internal heat sink may become hot when operating this product continuously. Do not touch hot areas, especially around the "Hot surface mark" and the top panel.

VORSICHT:

HEISSE OBERFLÄCHE. NICHT ANFASSEN.

Die Oberseite über dem inneren Kühlkörper könnte heiß werden, wenn dieses Produkt dauerhaft betrieben wird. Berühren Sie keine heißen Bereiche, hier besonders um die Kennzeichnung "Hot surface mark" und die Oberseite.

PRECAUTION:

SURFACE CHAUDE. NE PAS TOUCHER.

La surface supérieure du dissipateur de chaleur peut devenir chaude si vous utilisez ce produit en continu. Ne touchez pas les zones chaudes, tout particulièrement vers l'inscription "Hot surface mark" et le panneau supérieur.

ATTENZIONE:

SUPERFICIE CALDA. NON TOCCARE.

La superficie superiore al di sopra del dissipatore interno può riscaldarsi quando si adopera questo prodotto in maniera continuativa. Non toccare parti calde, in particolare quelle intorno alla dicitura "Hot surface mark" e al pannello superiore.

PRECAUCIÓN:

SUPERFICIE CALIENTE. NO TOCAR.

La superficie superior sobre el disipador de calor interno podría llegar a calentarse al operar este producto de forma continua. No toque las áreas calientes, especialmente las situadas alrededor de la "Hot surface mark" y del panel superior.

WAARSCHUWING:

HEET OPPEVLAK. NIET AANRAKEN.

Bij ononderbroken bediening van dit product kan het oppervlak boven de interne koelplaat heet worden. Raak het toestel niet aan waar het heet is, vooral niet in de buurt van het "Hot surface mark" en het bovenpaneel.

FÖRSIKTIHETSMÅTT:

VARM YTA. RÖR EJ.

Ytan ovanför den interna kylflänsen kan bli varm när produkten används kontinuerligt. Rör inte varma områden. Var särskilt försiktig vid märkningen "Hot surface mark" och på toppanelen.

□ **NOTE ON USE / HINWEIS ZUM GEBRAUCH / OBSERVATIONS RELATIVES A L'UTILISATION / NOTE SULL'USO / NOTAS SOBRE EL USO / ALVORENSTE GEBRUIKEN / OBSERVERA ANGÅENDE ANVÄNDNINGEN**

WARNINGS	WARNHINWEISE	AVERTISSEMENTS	AVVERTENZE	ADVERTENCIAS	WAARSCHUWINGEN	VARNINGAR
<ul style="list-style-type: none"> • Avoid high temperatures. Allow for sufficient heat dispersion when installed in a rack. • Handle the power cord carefully. Hold the plug when unplugging the cord. • Keep the unit free from moisture, water, and dust. • Unplug the power cord when not using the unit for long periods of time. • Do not obstruct the ventilation holes. • Do not let foreign objects into the unit. • Do not let insecticides, benzene, and thinner come in contact with the unit. • Never disassemble or modify the unit in any way. • Ventilation should not be impeded by covering the ventilation openings with items, such as newspapers, tablecloths or curtains. • Naked flame sources such as lighted candles should not be placed on the unit. • Observe and follow local regulations regarding battery disposal. • Do not expose the unit to dripping or splashing fluids. • Do not place objects filled with liquids, such as vases, on the unit. • Do not handle the mains cord with wet hands. • When the switch is in the OFF position, the equipment is not completely switched off from MAINS. • The equipment shall be installed near the power supply so that the power supply is easily accessible. 	<ul style="list-style-type: none"> • Vermeiden Sie hohe Temperaturen. Beachten Sie, dass eine ausreichende Belüftung gewährleistet wird, wenn das Gerät auf ein Regal gestellt wird. • Gehen Sie vorsichtig mit dem Netzkabel um. Halten Sie das Kabel am Stecker, wenn Sie den Stecker herausziehen. • Halten Sie das Gerät von Feuchtigkeit, Wasser und Staub fern. • Wenn das Gerät längere Zeit nicht verwendet werden soll, trennen Sie das Netzkabel vom Netzstecker. • Decken Sie den Lüftungsbereich nicht ab. • Lassen Sie keine fremden Gegenstände in das Gerät kommen. • Lassen Sie das Gerät nicht mit Insektiziden, Benzin oder Verdünnungsmitteln in Berührung kommen. • Versuchen Sie niemals das Gerät auseinander zu nehmen oder zu verändern. • Die Belüftung sollte auf keinen Fall durch das Abdecken der Belüftungsöffnungen durch Gegenstände wie beispielsweise Zeitungen, Tischtücher, Vorhänge o. Ä. behindert werden. • Auf dem Gerät sollten keinerlei direkte Feuerquellen wie beispielsweise angezündete Kerzen aufgestellt werden. • Bitte beachten Sie bei der Entsorgung der Batterien die örtlich geltenden Umweltbestimmungen. • Das Gerät sollte keiner tropfenden oder spritzenden Flüssigkeit ausgesetzt werden. • Auf dem Gerät sollten keine mit Flüssigkeit gefüllten Behälter wie beispielsweise Vasen aufgestellt werden. • Das Netzkabel nicht mit feuchten oder nassen Händen anfassen. • Wenn der Schalter ausgeschaltet ist (OFF-Position), ist das Gerät nicht vollständig vom Stromnetz (MAINS) abgetrennt. • Das Gerät sollte in der Nähe einer Netzsteckdose aufgestellt werden, damit es leicht an das Stromnetz angeschlossen werden kann. 	<ul style="list-style-type: none"> • Eviter des températures élevées. • Tenir compte d'une dispersion de chaleur suffisante lors de l'installation sur une étagère. • Manipuler le cordon d'alimentation avec précaution. Tenir la prise lors du débranchement du cordon. • Protéger l'appareil contre l'humidité, l'eau et la poussière. • Débrancher le cordon d'alimentation lorsque l'appareil n'est pas utilisé pendant de longues périodes. • Ne pas obstruer les trous d'aération. • Ne pas laisser des objets étrangers dans l'appareil. • Ne pas mettre en contact des insecticides, du benzène et un diluant avec l'appareil. • Ne jamais démonter ou modifier l'appareil d'une manière ou d'une autre. • Ne pas recouvrir les orifices de ventilation avec des objets tels que des journaux, nappes ou rideaux. Cela entraverait la ventilation. • Ne jamais placer de flamme nue sur l'appareil, notamment des bougies allumées. • Veillez à respecter les lois en vigueur lorsque vous jetez les piles usagées. • L'appareil ne doit pas être exposé à l'eau ou à l'humidité. • Ne pas poser d'objet contenant du liquide, par exemple un vase, sur l'appareil. • Ne pas manipuler le cordon d'alimentation avec les mains mouillées. • Lorsque l'interrupteur est sur la position OFF, l'appareil n'est pas complètement déconnecté du SECTEUR (MAINS). • L'appareil sera installé près de la source d'alimentation, de sorte que cette dernière soit facilement accessible. 	<ul style="list-style-type: none"> • Evitate di esporre l'unità a temperature elevate. • Assicuratevi che vi sia un'adeguata dispersione del calore quando installate l'unità in un mobile per componenti audio. • Maneggiate il cavo di alimentazione con attenzione. Tenete ferma la spina quando scollegate il cavo dalla presa. • Tenete l'unità lontana dall'umidità, dall'acqua e dalla polvere. • Scollegate il cavo di alimentazione quando prevedete di non utilizzare l'unità per un lungo periodo di tempo. • Non coprite i fori di ventilazione. • Non inserite corpi estranei all'interno dell'unità. • Assicuratevi che l'unità non entri in contatto con insetticidi, benzolo o solventi. • Non smontate né modificate l'unità in alcun modo. • Le aperture di ventilazione non devono essere ostruite coprendole con oggetti, quali giornali, tovaglie, tende e così via. • Non posizionate sull'unità fi amme libere, come ad esempio candele accese. • Prestate attenzione agli aspetti legati alla tutela dell'ambiente nello smaltimento delle batterie. • L'apparecchiatura non deve essere esposta a goccioli o spruzzi. • Non posizionate sull'unità alcun oggetto contenente liquidi, come ad esempio i vasi. • Non toccare il cavo di alimentazione con le mani bagnate. • Quando l'interruttore è nella posizione OFF, l'apparecchiatura non è completamente scollegata da MAINS. • L'apparecchio va installato in prossimità della fonte di alimentazione, in modo che quest'ultima sia facilmente accessibile. 	<ul style="list-style-type: none"> • Evite altas temperaturas. Permita la suficiente dispersión del calor cuando está instalado en la consola. • Maneje el cordón de energía con cuidado. Sostenga el enchufe cuando desconecte el cordón de energía. • Mantenga el equipo libre de humedad, agua y polvo. • Desconecte el cordón de energía cuando no utilice el equipo por mucho tiempo. • No obstruya los orificios de ventilación. • No deje objetos extraños dentro del equipo. • No permita el contacto de insecticidas, gasolina y diluyentes con el equipo. • Nunca desarme o modifique el equipo de ninguna manera. • La ventilación no debe quedar obstruida por haberse cubierto las aperturas con objetos como periódicos, manteles o cortinas. • No deberán colocarse sobre el aparato fuentes inflamables sin protección, como velas encendidas. • A la hora de deshacerse de las pilas, respete la normativa para el cuidado del medio ambiente. • No exponer el aparato al goteo o salpicaduras cuando se utilice. • No colocar sobre el aparato objetos llenos de líquido, como jarras. • No maneje el cable de alimentación con las manos mojadas. • Cuando el interruptor está en la posición OFF, el equipo no está completamente desconectado de la alimentación MAINS. • El equipo se instalará cerca de la fuente de alimentación de manera que resulte fácil acceder a ella. 	<ul style="list-style-type: none"> • Vermijd hoge temperaturen. Zorg er bij installatie in een audiorack voor, dat de door het toestel geproduceerde warmte goed kan worden afgevoerd. • Hanteer het netsnoer voorzichtig. Houd het snoer bij de stekker vast wanneer deze moet worden aan- of losgekoppeld. • Laat geen vochtigheid, water of stof in het apparaat binnendringen. • Neem altijd het netsnoer uit het stopcontact wanneer het apparaat gedurende een lange periode niet wordt gebruikt. • De ventilatieopeningen mogen niet worden geblokkeerd. • Laat geen vreemde voorwerpen in dit apparaat vallen. • Voorkom dat insecticiden, benzene of verfvendunners met dit toestel in contact komen. • Dit toestel mag niet gedemonteerd of aangepast worden. • De ventilatie mag niet worden belemmerd door de ventilatieopeningen af te dekken met bijvoorbeeld kranten, een tafelkleed of gordijnen. • Plaats geen open vlammen, bijvoorbeeld een brandende kaars, op het apparaat. • Houd u steeds aan de milieuvoorschriften wanneer u gebruikte batterijen wegdoet. • Stel het apparaat niet bloot aan druppels of spatten. • Plaats geen voorwerpen gevuld met water, bijvoorbeeld een vaas, op het apparaat. • Raak het netsnoer niet met natte handen aan. • Als de schakelaar op OFF staat, is het apparaat niet volledig losgekoppeld van de netspanning (MAINS). • De apparatuur wordt in de buurt van het stopcontact geïnstalleerd, zodat dit altijd gemakkelijk toegankelijk is. 	<ul style="list-style-type: none"> • Undvik höga temperaturer. Se till att det finns möjlighet till god värmeavledning vid montering i ett rack. • Hantera nätkabeln varsamt. Håll i kabeln när den kopplas från el-uttaget. • Utsätt inte apparaten för fukt, vatten och damm. • Koppla loss nätkabeln om apparaten inte kommer att användas i lång tid. • Täpp inte till ventilationsöppningarna. • Se till att främmande föremål inte tränger in i apparaten. • Se till att inte insektsmedel på spraybruk, bensen och thinner kommer i kontakt med apparatens hölje. • Ta inte isär apparaten och försök inte bygga om den. • Ventilationen bör inte förhindras genom att täcka för ventilationsöppningarna med föremål såsom tidningar, bordsdukar eller gardiner. • Placera inte öppen eld, t.ex. tända ljus, på apparaten. • Tänk på miljöaspekterna när du bortskaffar batterier. • Apparaten får inte utsättas för vätska. • Placera inte föremål fyllda med vätska, t.ex. vaser, på apparaten. • Hantera inte nätsladden med våta händer. • Även om strömbrytaren står i det avstängda läget OFF, så är utrustningen inte helt bortkopplad från det elektriska nätet (MAINS). • Utrustningen ska vara installerad nära strömuttaget så att strömförsörjningen är lätt att tillgå.

• DECLARATION OF CONFORMITY

We declare under our sole responsibility that this product, to which this declaration relates, is in conformity with the following standards: EN60065, EN55013, EN55020, EN61000-3-2 and EN61000-3-3.

Following the provisions of Low Voltage Directive 2006/95/EC and EMC Directive 2004/108/EC, the EC regulation 1275/2008 and its frame work Directive 2009/125/EC for Energy-related Products (ErP).

• ÜBEREINSTIMMUNGSERKLÄRUNG

Wir erklären unter unserer Verantwortung, daß dieses Produkt, auf das sich diese Erklärung bezieht, den folgenden Standards entspricht: EN60065, EN55013, EN55020, EN61000-3-2 und EN61000-3-3.

Gemäß den Bestimmungen der Niederspannungsrichtlinie 2006/95/EG und EMV Richtlinie 2004/108/EG, der Verordnung (EG) Nr. 1275/2008 der Kommission und deren Rahmenrichtlinie 2009/125/EG zu energieverbrauchsrelevanten Produkten (ErP).

• DECLARATION DE CONFORMITE

Nous déclarons sous notre seule responsabilité que l'appareil, auquel se réfère cette déclaration, est conforme aux standards suivants: EN60065, EN55013, EN55020, EN61000-3-2 et EN61000-3-3.

Selon la directive 2006/95/EC concernant la basse tension et la directive CEM 2004/108/EC, la réglementation européenne 1275/2008 et la directive 2009/125/EC établissant un cadre de travail applicable aux produits liés à l'énergie (ErP).

• DICHIARAZIONE DI CONFORMITÀ

Dichiaro con piena responsabilità che questo prodotto, al quale la nostra dichiarazione si riferisce, è conforme alle seguenti normative: EN60065, EN55013, EN55020, EN61000-3-2 e EN61000-3-3.

Facendo seguito alle disposizioni della direttiva sul basso voltaggio 2006/95/EC alla direttiva EMC 2004/108/EC, alla norma EC 1275/2008 e alla relativa legge quadro 2009/125/EC in materia di prodotti alimentati ad energia (ErP).

QUESTO PRODOTTO È CONFORME

AL D.M. 28/08/95 N. 548

• DECLARACIÓN DE CONFORMIDAD

Declaramos bajo nuestra exclusiva responsabilidad que este producto al que hace referencia esta declaración, está conforme con los siguientes estándares:

EN60065, EN55013, EN55020, EN61000-3-2 y EN61000-3-3.

De acuerdo con la directiva sobre baja tensión 2006/95/CE y la directiva sobre CEM 2004/108/CE, la normativa CE 1275/2008 y su directiva marco 2009/125/EC para productos relacionados con la energía (ErP).

• EENVORMIGHEIDSVERKLARING

Wij verklaren uitsluitend op onze verantwoordelijkheid dat dit product, waarop deze verklaring betrekking heeft, in overeenstemming is met de volgende normen:

EN60065, EN55013, EN55020, EN61000-3-2 en EN61000-3-3.

Volgens de voorzieningen van lage spanningsrichtlijn 2006/95/EC en EMC-richtlijn 2004/108/EC, de EU-richtlijn 1275/2008 en de kaderrichtlijn 2009/125/EC voor energieverbruikende producten (ErP).

• ÖVERENSSTÄMMELSEINTYG

Härmed intygas helt på eget ansvar att denna produkt, vilken detta intyg avser, uppfyller följande standarder:

EN60065, EN55013, EN55020, EN61000-3-2 och EN61000-3-3.

Uppfyller reglerna i lågspänningsdirektiv 2006/95/EC och

EMC-direktivet 2004/108/EC, EU-förordningen 1275/2008 och

ramverksdirektivet 2009/125/EC för energirelaterade produkter (ErP).

Marantz Europe

A division of D&M Europe B.V.

Beemdstraat 11, 5653 MA Eindhoven,

The Netherlands

A NOTE ABOUT RECYCLING:

This product's packaging materials are recyclable and can be reused. Please dispose of any materials in accordance with the local recycling regulations.

When discarding the unit, comply with local rules or regulations.

Batteries should never be thrown away or incinerated but disposed of in accordance with the local regulations concerning battery disposal.

This product and the supplied accessories, excluding the batteries, constitute the applicable product according to the WEEE directive.

HINWEIS ZUM RECYCLING:

Das Verpackungsmaterial dieses Produktes ist zum Recyceln geeignet und kann wieder verwendet werden. Bitte entsorgen Sie alle Materialien entsprechend der örtlichen Recycling-Vorschriften.

Beachten Sie bei der Entsorgung des Gerätes die örtlichen Vorschriften und Bestimmungen.

Die Batterien dürfen nicht in den Hausmüll geworfen oder verbrannt werden; bitte entsorgen Sie die Batterien gemäß der örtlichen Vorschriften.

Dieses Produkt und das im Lieferumfang enthaltene Zubehör (mit Ausnahme der Batterien!) entsprechen der WEEE-Direktive.

UNE REMARQUE CONCERNANT LE RECYCLAGE:

Les matériaux d'emballage de ce produit sont recyclables et peuvent être réutilisés. Veuillez disposer des matériaux conformément aux lois sur le recyclage en vigueur.

Lorsque vous mettez cet appareil au rebut, respectez les lois ou réglementations en vigueur.

Les piles ne doivent jamais être jetées ou incinérées, mais mises au rebut conformément aux lois en vigueur sur la mise au rebut des piles.

Ce produit et les accessoires inclus, à l'exception des piles, sont des produits conformes à la directive DEEE.

NOTA RELATIVA AL RICICLAGGIO:

I materiali di imballaggio di questo prodotto sono riutilizzabili e riciclabili. Smaltire i materiali conformemente alle normative locali sul riciclaggio.

Per lo smaltimento dell'unità, osservare le normative o le leggi locali in vigore.

Non gettare le batterie, né incenerirle, ma smaltirle conformemente alla normativa locale sui rifiuti chimici.

Questo prodotto e gli accessori inclusi nell'imballaggio sono applicabili alla direttiva RAEE, ad eccezione delle batterie.

ACERCA DEL RECICLAJE:

Los materiales de embalaje de este producto son reciclables y se pueden volver a utilizar. Disponga de estos materiales siguiendo los reglamentos de reciclaje de su localidad.

Cuando se deshaga de la unidad, cumpla con las reglas o reglamentos locales.

Las pilas nunca deberán tirarse ni incinerarse. Deberá disponer de ellas siguiendo los reglamentos de su localidad relacionados con los desperdicios químicos.

Este producto junto con los accesorios empaquetados es el producto aplicable a la directiva RAEE excepto pilas.

EEN AANTEKENING MET BETREKKING TOT DE RECYCLING:

Het inpakmateriaal van dit product is recycleerbaar en kan opnieuw gebruikt worden. Er wordt verzocht om zich van elk afvalmateriaal te ontdoen volgens de plaatselijke voorschriften.

Volg voor het wegdoen van de speler de voorschriften voor de verwijdering van wit- en bruingoed op.

Batterijen mogen nooit worden weggegooid of verbrand, maar moeten volgens de plaatselijke voorschriften betreffende chemisch afval worden verwijderd.

Op dit product en de meegeleverde accessoires, m.u.v. de batterijen is de richtlijn voor afgedankte elektrische en elektronische apparaten (WEEE) van toepassing.

OBSERVERA ANGÅENDE ÅTERVINNING:

Produktens emballage är återvinningsbart och kan återanvändas. Kassera det enligt lokala återvinningsbestämmelser.

När du kasserar enheten ska du göra det i överensstämmelse med lokala regler och bestämmelser. Batterier får absolut inte kastas i soporna eller brännas. Kassera dem enligt lokala bestämmelser för kemiskt avfall.

Denna apparat och de tillbehör som levereras med den uppfyller gällande WEEE-direktiv, med undantag av batterierna.



Pb

CAUTIONS ON INSTALLATION
VORSICHTSHINWEISE ZUR AUFSTELLUNG
PRÉCAUTIONS D'INSTALLATION
PRECAUZIONI SULL'INSTALLAZIONE
EMPLAZAMIENTO DE LA INSTALACIÓN
VOORZORGSMAATREGELEN BIJ DE
INSTALLATIE
FÖRSIKTIGHET VID INSTALLATIONEN

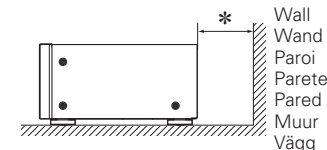
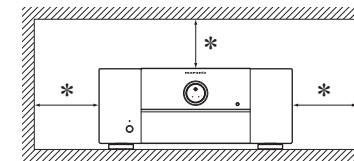

Wall
Wand
Parete
Pared
Muur
Vägg

* For proper heat dispersal, do not install this unit in a confined space, such as a bookcase or similar enclosure.

- More than 0.3 m is recommended.
- Do not place any other equipment on this unit.

* Stellen Sie das Gerät nicht an einem geschlossenen Ort, wie in einem Bücherregal oder einer ähnlichen Einrichtung auf, da dies eine ausreichende Belüftung des Geräts behindern könnte.

- Empfohlen wird über 0,3 m.
- Keine anderen Gegenstände auf das Gerät stellen.

* Pour permettre la dissipation de chaleur requise, n'installez pas cette unité dans un espace confiné tel qu'une bibliothèque ou un endroit similaire.

- Une distance de plus de 0,3 m est recommandée.
- Ne placez aucun matériel sur cet appareil.

* Per una dispersione adeguata del calore, non installare questa apparecchiatura in uno spazio ristretto, come ad esempio una libreria o simili.

- Si raccomanda una distanza superiore ai 0,3 m.
- Non posizionare alcun altro oggetto o dispositivo su questo dispositivo.

* Para la dispersión del calor adecuadamente, no instale este equipo en un lugar confinado tal como una librería o unidad similar.

- Se recomienda dejar más de 0,3 m alrededor.
- No coloque ningún otro equipo sobre la unidad.

* Plaats dit toestel niet in een kleine afgesloten ruimte, zoals een boekenkast e.d., omdat anders de warmte niet op gepaste wijze kan worden afgevoerd.

- Meer dan 0,3 m is aanbevolen.
- Plaats geen andere apparatuur op het toestel.

* För att tillförsäkra god värmeavledning får utrustningen inte installeras i instängda utrymmen, som t.ex. en bokhylla eller liknande.

- Mer än 0,3 m rekommenderas.
- Placera ingen annan utrustning ovanpå den här enheten.

Усилитель

Marantz MM7055/MM7025

(РУКОВОДСТВО ПО ЭКСПЛУАТАЦИИ)



Вы приобрели усилитель мощности производства компании “D&M Холдингс Инк”, Япония (“D & M Holdings Inc.”, Japan). Модель MM7055/MM7025 является многоканальным усилителем и предназначена для многоканального усиления звука в домашних аудиосистемах. Это изделие широко известно в кругах истинных ценителей высококлассного звука. Качество и безопасность подтверждены множеством тестов, проведенных как зарубежными, так и российскими испытательными лабораториями.

Изготовитель в течение 3 лет (срок службы) после выпуска данного изделия обеспечивает наличие комплектующих в целях возможности проведения ремонта и технического обслуживания, по истечении которого эксплуатация и техническое обслуживание продолжается в соответствии с действующими нормативными документами. Изделие остается безопасным для жизни, здоровья человека и окружающей среды в течение всего срока эксплуатации. Гарантийный срок - 1 год.

Информация о Российской сертификации

Но сертификата соответствия	Орган по сертификации	Нормативные документы	Наименование сертифицированной продукции	Срок действия сертификата
РОСС JPAЯ46.B15095	РОСТЕСТ-МОСКВА	ГОСТ Р МЭК 60065-2005 ГОСТ 22505-97 ГОСТ Р 51515-99 ГОСТ Р 51317.3.2-99 ГОСТ Р 51317.3.3-99	Устройства усилительные/ преобразовательные	До 17.04.2011

Основные технические характеристики

См. в конце инструкции

ВНИМАНИЕ: Если Вы приобрели аудиоаппаратуру надлежащего качества, то, по Российским законам, она не подлежит возврату или обмену на аналогичный товар других размера, формы и т.д.

D&M Холдингс Инк
Здание D&M, 2-1 Ниссин-тё
Кавасаки-ку, Кавасаки-си, Канагава
2108569, Япония

D&M Holdings Inc.
D&M Building, 2-1 Nisshin-Cho
Kawasaki-Ku, Kawasaki-Shi, Kanagawa
2108569, Japan

Getting started

Thank you for purchasing this Marantz product. To ensure proper operation, please read this user guide carefully before using the product.

After reading them, be sure to keep them for future reference.

Contents

Getting started	1
Accessories	1
About this manual.....	1
Features.....	2
Cautions on handling	2
Part names	3
Front panel.....	3
Rear panel.....	3
Connections	4
Preparations.....	4
Speaker connections	4
Example connection variation	5
Connecting MM7055 with an AV pre-tuner (AV7005)	6
Connecting the power cord	7
Remote control connection	7
Connection to an external control device	8
Operations	9
Turning the power on	9
Turning the power standby.....	9
Switching the illumination lamp ON/OFF.....	9
Setting the power to standby automatically (Auto standby function)	9
Explanation of terms	10
Troubleshooting	10
Specifications	11
Index	11

Accessories

Check that the following parts are supplied with the product.

- ① User guide 1
- ② Power cord 1
- ③ Remote control cable 1

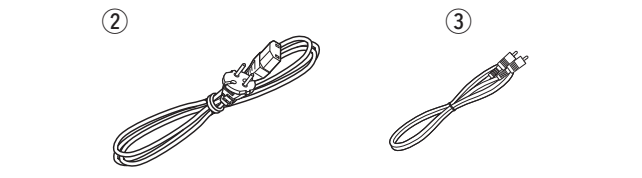

About this manual

☐ Symbols



This symbol indicates a reference page on which related information is described.



This symbol indicates a supplementary information and tips for operations.

NOTE

This symbol indicates a supplementary information and tips for operations.

☐ Illustrations

Note that the illustrations in these instructions are for explanation purposes and may differ from the actual unit.

Features

Current feedback discrete power amp

This is equipped with a current feedback power amp that uses the complimentary push-pull circuit used in the SM-11S1 Marantz Hi-Fi power amp. This amp provides increased operating stability, and high-speed, wide ranging high-density playback.

The current/voltage conversion amplification section in the latter part of the power amp is equipped with a Wilson current mirror circuit that amplifies to the high sound range with low distortion.

Improved instant power supply capability

The final stage of the power amp is equipped with the same LAPT (high efficiency power transistor) that is installed in the SM-11S1 Marantz Hi-Fi power amp, providing improved instant power supply capability.

The power section is equipped with a large-sized transformer.

As one of the essential parts of the power section, this unit is equipped with Marantz original 33,000 μF / 71 V \times 2 (MM7055), and 15,000 μF / 71 V \times 2 (MM7025) block condensers, which have been repeatedly tested for sound quality.

These improvements to the power supply capability provide a powerful, presence-filled sound.

High sound quality design based on pure surround philosophy

Equipped with a chimney-shaped heat sink to efficiently process the heat emitted from each channel amp, and exceptionally quiet cooling fans. A high-sensitivity temperature sensor IC is used to control the cooling fans, adjusting the rotation speed to match the amount of heat generated by the amp.

These components provide the sound quality and low-noise you would expect at a high-end theater.

In addition, this unit is designed for superb quality sound, and is equipped with high quality components such as a high-end audio condenser and film condenser throughout.

BALANCED/UNBALANCED selecting function

Depending on the desired use, input for each channel can be selected between BALANCED input and UNBALANCED input.

Remote Power Control

This unit is equipped with a remote power control function. When a Marantz AV Pretuner AV8003 or AV7005 is connected to this unit, this unit's power can be switched ON/OFF together with the AV8003 or AV7005 power supply.

Connection to the AV8003 or AV7005 is a ground floating connection that prevents negative influences on sound quality as far as possible.

Other Functions

Equipped with IR flash input that supports custom installations, and DC trigger input and output terminals.

Cautions on handling

• Before turning the power switch on

Check once again that all connections are correct and that there are no problems with the connection cables.

- Power is supplied to some of the circuitry even when the unit is set to the standby mode. When going on vacation or leaving home for long periods of time, be sure to unplug the power cord from the power outlet.

• About condensation

If there is a major difference in temperature between the inside of the unit and the surroundings, condensation (dew) may form on the operating parts inside the unit, causing the unit not to operate properly.

If this happens, let the unit sit for an hour or two with the power turned off and wait until there is little difference in temperature before using the unit.

• Cautions on using mobile phones

Using a mobile phone near this unit may result in noise. If that occurs, move the mobile phone away from this unit when it is in use.

• Moving the unit

Turn off the power and unplug the power cord from the power outlet. Next, disconnect the connection cables to other system units before moving the unit.

• About Care

- Wipe the cabinet and control panel clean with a soft cloth.
- Follow the instructions when using a chemical cleaner.
- Benzene, paint thinner or other organic solvents as well as insecticide may cause material changes and discoloration if brought into contact with the unit, and should therefore not be used.

Part names

Front panel

For buttons not explained here, see the page indicated in parentheses ().

MM7055

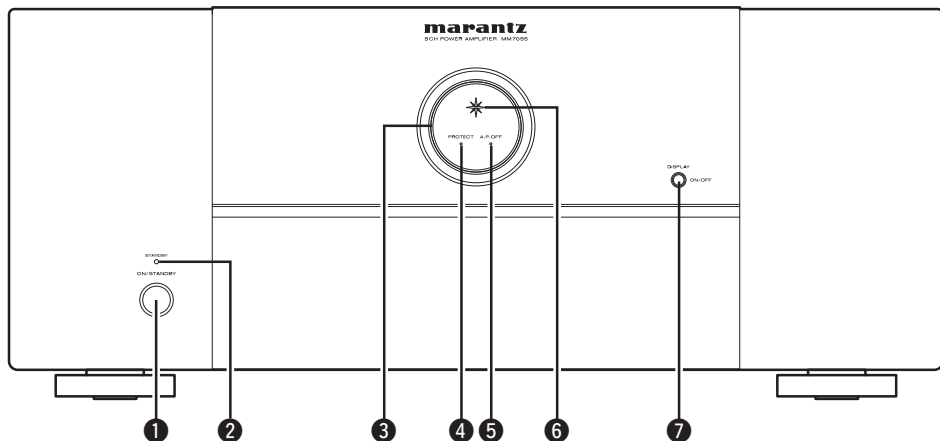

MM7025

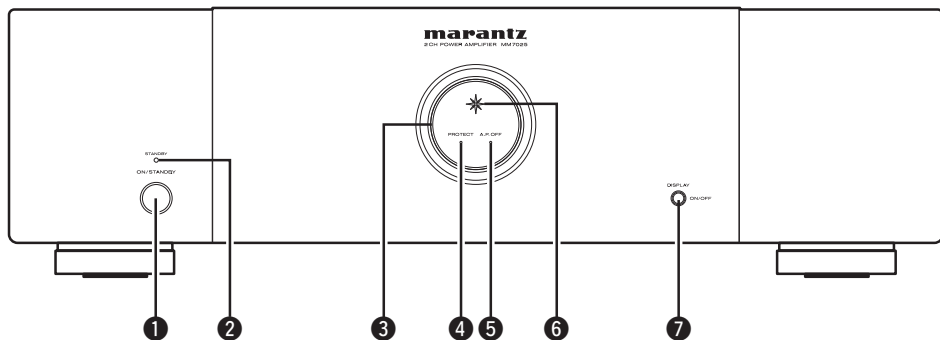

- 1 Power switch (ON/STANDBY) (9)
- 2 STANDBY indicator (9)
- 3 Illumination lamp (9)
- 4 Protection indicator (PROTECT) (9, 10)
- 5 Auto power off indicator (A.P.OFF) (9)
- 6 Power indicator (9)
- 7 DISPLAY button (9)
 - Press this button to turn the illumination lamp ON/OFF.
 - You can set the auto standby function by pressing and holding this button for more than 5 seconds.

Rear panel

See the page indicated in parentheses ().

MM7055

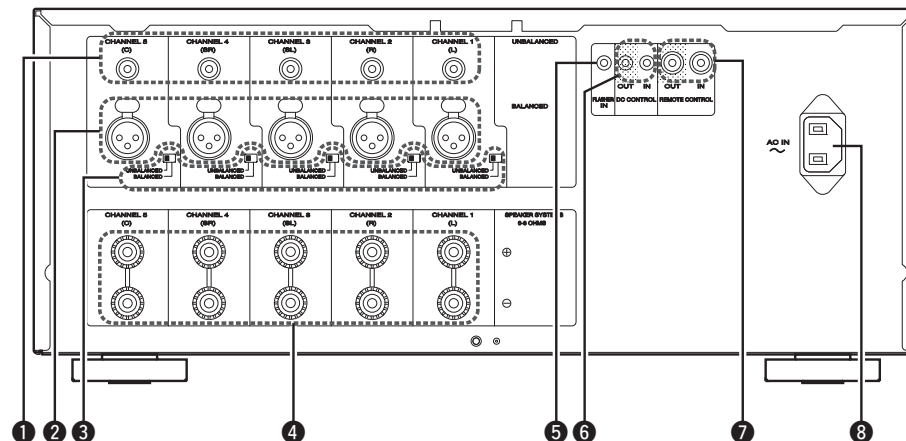

MM7025

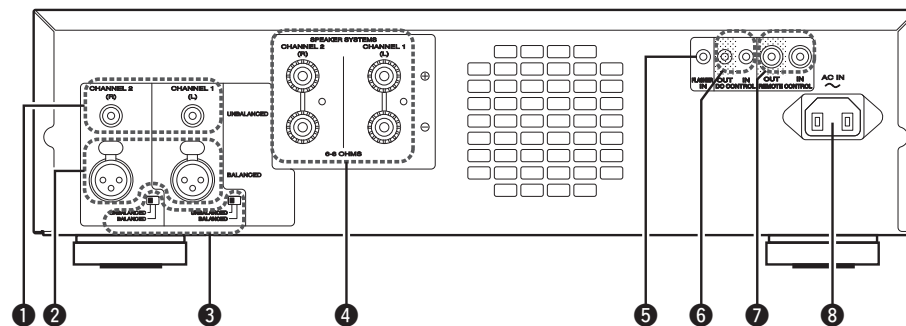

- 1 RCA input connectors (UNBALANCED) (6)
- 2 XLR input connectors (BALANCED) (6)
- 3 Input selector (4)
- 4 Speaker terminals (SPEAKER SYSTEMS) (6)
- 5 Flasher input terminals (FLASHER IN) (8)
- 6 DC CONTROL jacks (8)
- 7 REMOTE CONTROL connectors (7, 8)
- 8 AC inlet (AC IN) (7)

Connections



NOTE

- Do not plug in the power cord until all connections have been completed.
- When making connections, also refer to the operating instructions of the other components being connected.
- Check the channel, and then connect correctly.
- Do not bundle power cords together with connection cables. Doing so can result in noise.

Preparations

Cables used for connections

Prepare the correct cables for use with the additional devices.

Audio cables	
Balanced connections (XLR)	 <p>Balanced cable</p>
Unbalanced connections (RCA)	 <p>Audio cable</p>
Speaker connections	 <p>Speaker cable</p>

Sets the connected input connectors

Switches the input settings used for input to each channel.



BALANCED: Set when connected to the XLR connector.
UNBALANCED: Set when connected to the RCA connector.

NOTE

If audio is input into input connectors that are not set using the input switching switch, the audio will not be output from the speakers.

XLR connector PIN arrangement

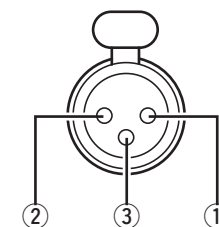

- ① GND (Ground)
- ② HOT (Hot)
- ③ COLD (Cold)

The PIN arrangement in this device uses the European method. In the USA method, ② is COLD, and ③ is HOT.

When connecting a device that utilizes the USA type of PIN arrangement, replace the ② and ③ plugs on one side of the balanced cable.

NOTE

Do not short the HOT and GND or COLD and GND for use.

Speaker connections

Carefully check the channels of the speakers to be connected to this unit (L/R/SL/SR/C) and + (red), - (black), and connect like poles together.

NOTE

- Connect so that the speaker cable core wires do not protrude from the speaker terminal. The protection circuit may be activated if the core wires touch the rear panel or if the + and - sides touch each other (see page 10 "Protection circuit").
- Never touch the speaker terminals while the power supply is connected. Doing so could result in electric shock.
- Use speakers with impedance of 6 ohms or more.

Connecting the speaker cables

Peel off about 10 mm of sheathing from the tip of the speaker cable, then either twist the core wire tightly or terminate it.

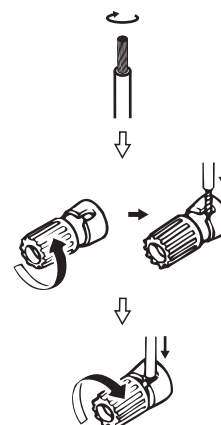

Example connection variation

Connection to an AV pre-tuner

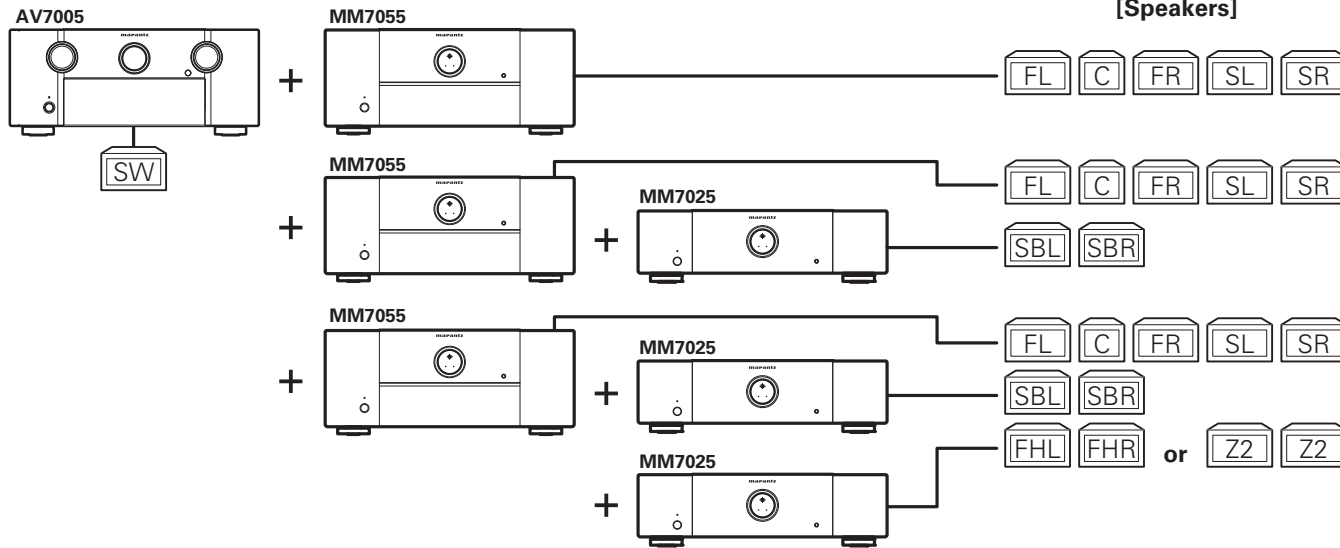

➔ 5.1ch surround playback

➔ 7.1ch surround playback

➔ 9.1ch surround playback
or
7.1ch surround playback
+
ZONE2 playback

Connection to an AV receiver

Using both the AV receiver and the amplifier of this unit. Combine with an AV receiver that has a pre-out output.

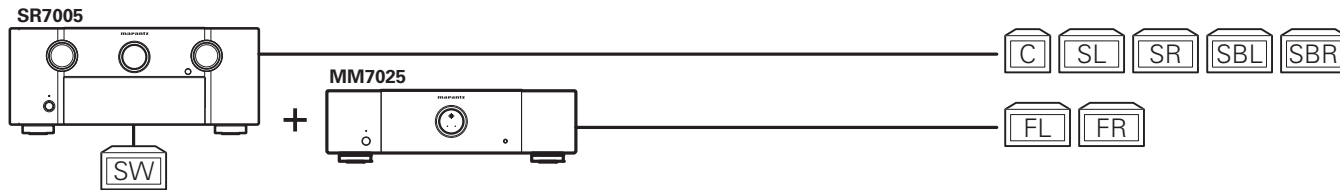

➔ Front speaker upgrade

Connection to a 2ch pre-amp

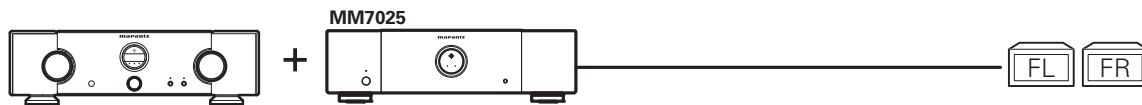

➔ 2ch playback

FL Front speaker (L)	C Center speaker	SL Surround speaker (L)	SBL Surround back speaker (L)	FHL Front height speaker (L)
FR Front speaker (R)	SW Subwoofer	SR Surround speaker (R)	SBR Surround back speaker (R)	FHR Front height speaker (R)
Z2 Zone2 speaker				

Getting started

Part names

Connections

Operations

Explanation of terms

Troubleshooting

Specifications

Index

Connecting MM7055 with an AV pre-tuner (AV7005)

The illustrations below show connection examples for performing 5.1-channel surround playback using the MM7055 and AV pre-tuner (AV7005).



- For settings and operating procedures of the AV7005, see the AV7005 instruction manual.
- When connecting the AV7005, be sure to also consult the AV7005 instruction manual.

Balanced connections (when connecting to the XLR input connectors)

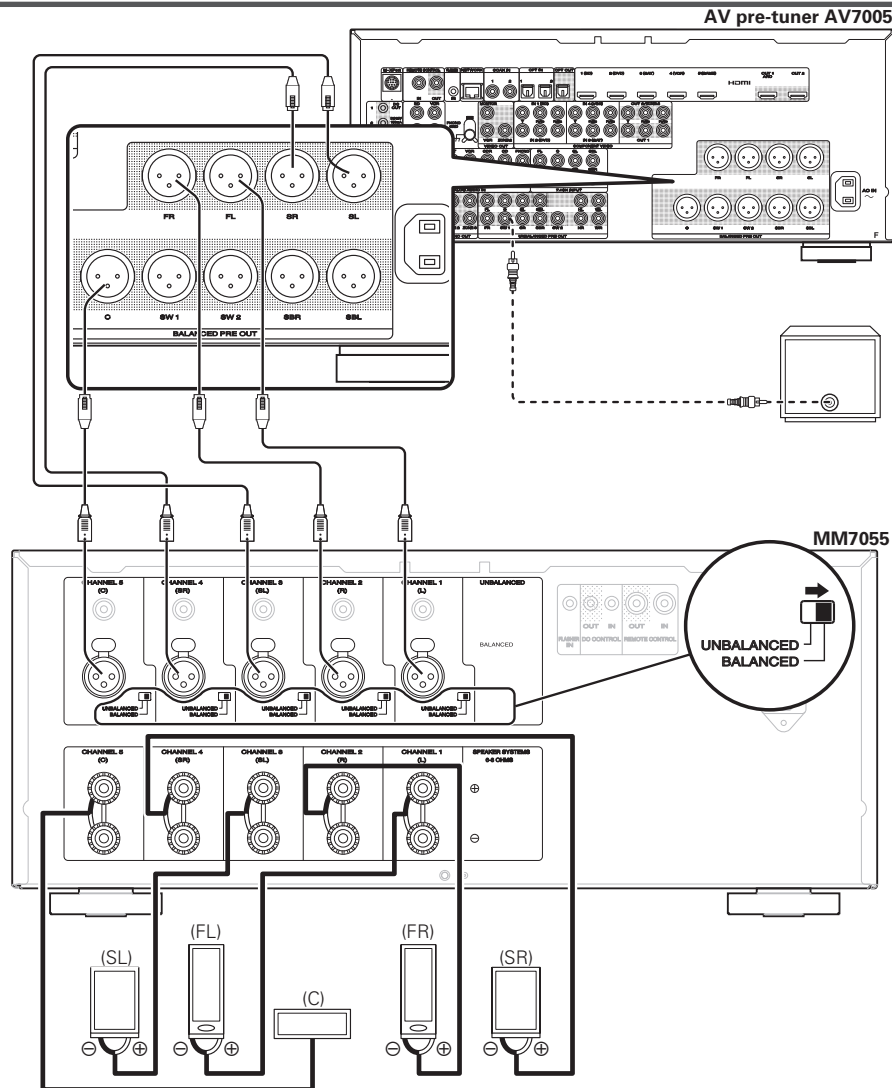

Unbalanced connections (when connecting to the RCA input connectors)

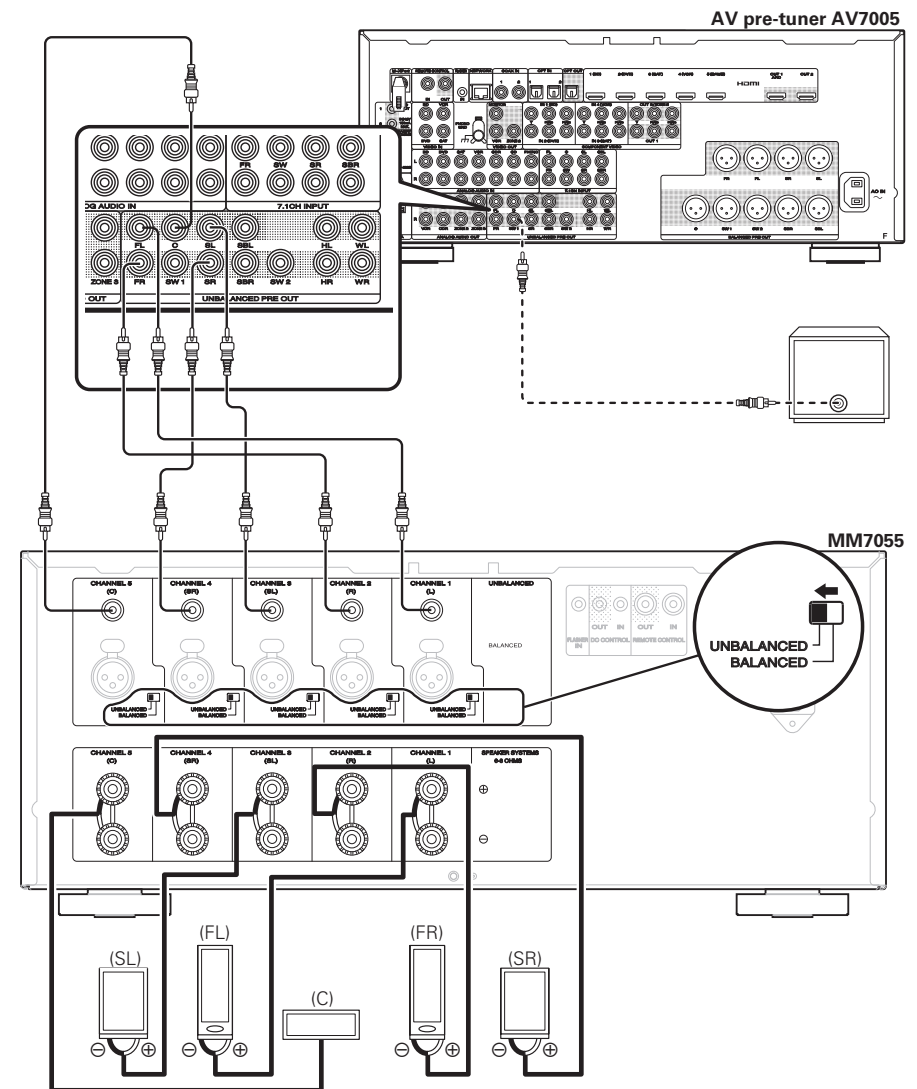

Connecting the power cord

Wait until all connections have been completed before connecting the power cord.

MM7055

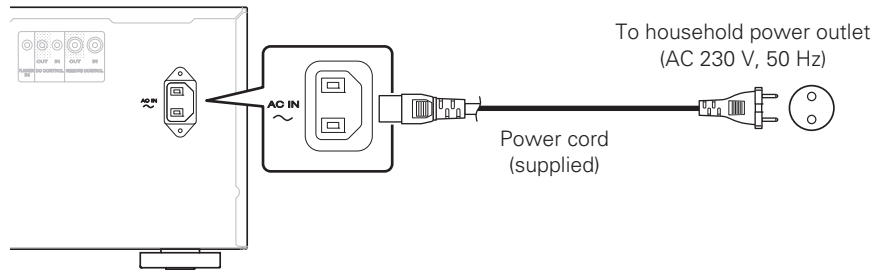

MM7025

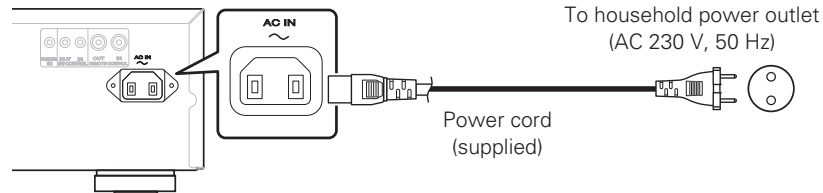

NOTE

- Insert the plugs securely. Loose connections will result in the generation of noise.
- During power standby, a minimal amount of power is consumed. To totally cut off the power, remove the power cord from the power outlet.

Remote control connection

When connecting a Marantz AV8003 or AV7005 AV pre-tuner, you can switch the power of this unit to ON/STANDBY together with the AV8003/AV7005 power supply. For details, see the AV8003 or AV7005 instruction manual.

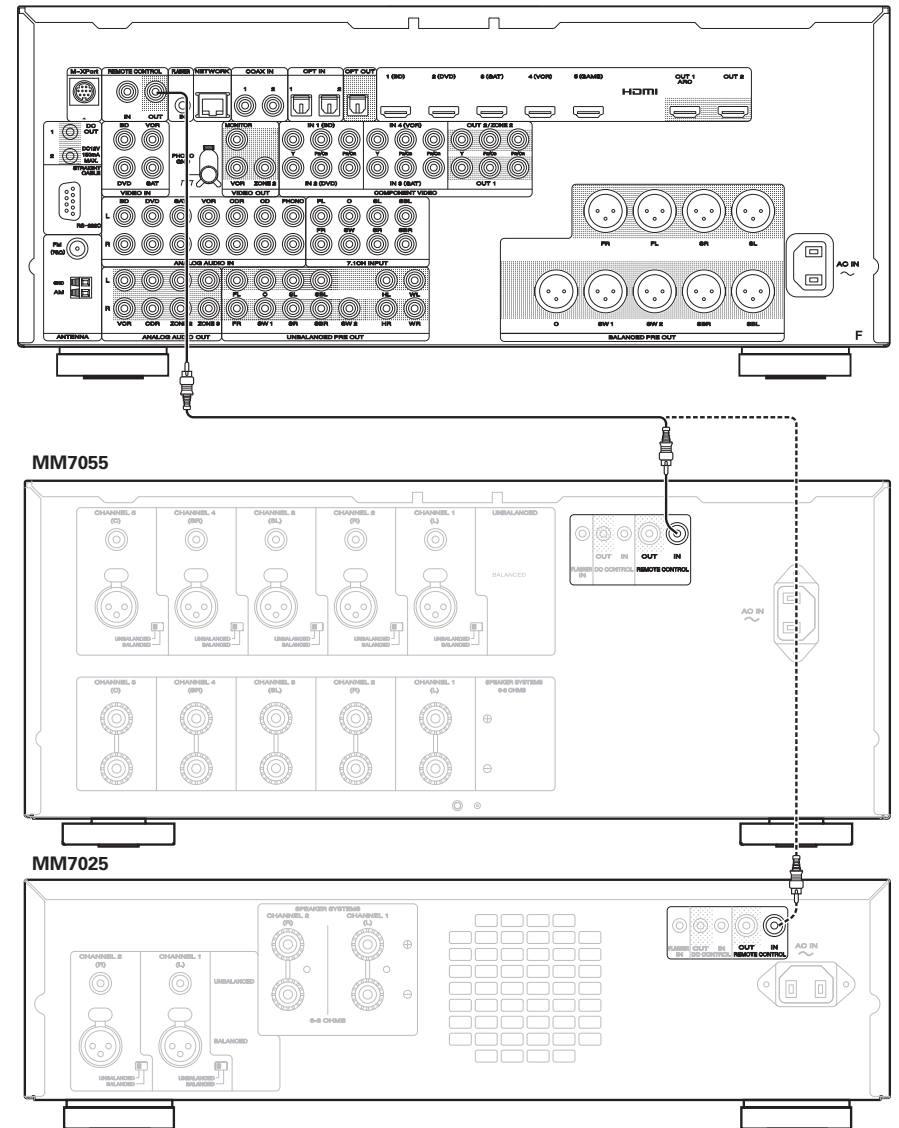

Connection to an external control device

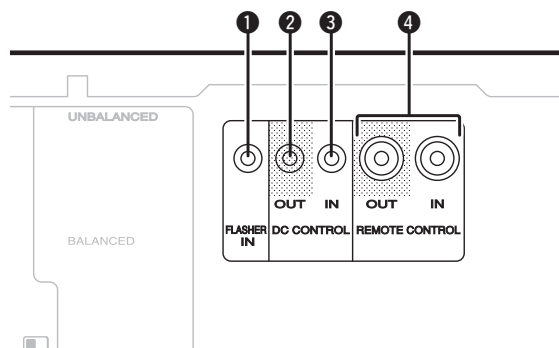

1 Flasher input connector (FLASHER IN)

Used when connecting a control box or other control device to this unit, and using such a device to control this unit.

2 DC control output connector (DC CONTROL OUT)

Used when connecting a device that has a DC control input terminal to this unit, and linking the power ON/STANDBY function of this device with the power ON/STANDBY of the connected device.

An electrical signal of max 12 V/44 mA is output from the DC control output terminal.

For details, see the instruction manual of the connected device.

NOTE

Do not use the DC control output terminal as the power supply for an external device.

3 DC control input connector (DC CONTROL IN)

Used when connecting a unit that has a DC control input terminal to this device, and linking the power ON/STANDBY of the connected device with the power ON/STANDBY of this unit.

For details, see the instruction manual of the connected device.

NOTE

When a 5 V – 15 V voltage is input to the DC control input terminal, the power of this unit switches ON.

However, inputting voltage outside of this range will cause damage to this unit.

4 Remote control connector

Used when connecting an external control device to this unit, and using the device to control this unit.

NOTE

When connecting a Marantz AV8003 or AV7005 AV pre-tuner, you can switch the power of this unit to ON/STANDBY together with the AV8003/AV7005 power supply.

For details, see the AV8003 or AV7005 instruction manual.

Operations

MM7055

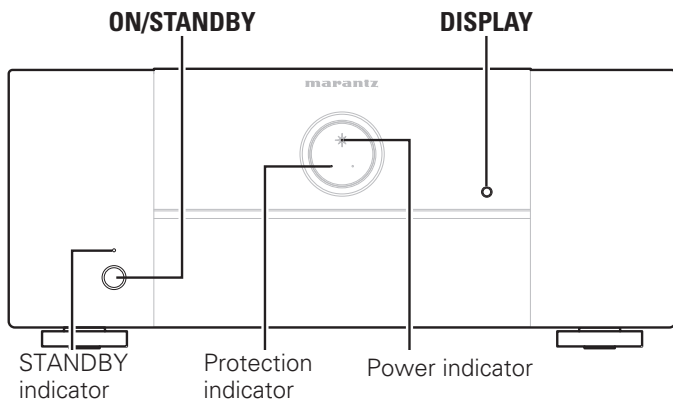

MM7025

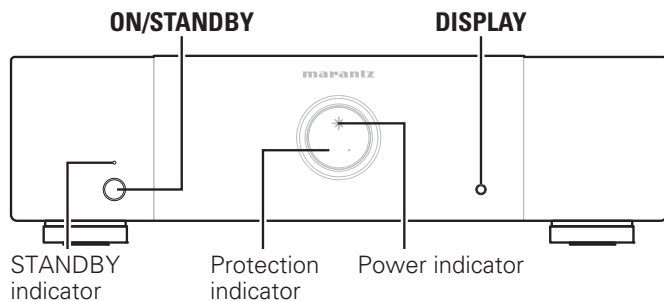

Turning the power on

When the power is in standby, press **ON/STANDBY**.

- The protection indicator flashes for approximately 7 seconds, and the power switches on.
- The power indicator lights.

NOTE

When turning the power ON, turn the volume control of connected devices down to the minimum.

Turning the power standby

When the power is in power on, press **ON/STANDBY**.

The STANDBY indicator lights, and the power changes to standby.

NOTE

Even if the unit is switched to standby, some of the circuits are still active. If you will not be using this unit for a prolonged period (due to a holiday etc), remove the power plug from the wall socket.

Furthermore, to prevent unexpected accidents, make sure the power plug is located where it can be removed at any time.

Switching the illumination lamp ON/OFF

If the unit is being used with the factory settings, the illumination lamp lights.

You can turn the illumination lamp off if it is making the room too bright at nighttime.

Press **DISPLAY**.

Each time this button is pressed, the illumination lamp turns ON/OFF.

Setting the power to standby automatically (Auto standby function)

When the auto standby function is set to ON, if there are no signals input into this unit and no operations are performed for more than 30 minutes, the power of this unit automatically switches to standby.

- The factory setting is "Off".

Press **DISPLAY** for more than 5 seconds.

The auto power off display switches as shown below according to the auto standby function.

- When the auto standby function is ON: Lit
- When the auto standby function is OFF: Off

Explanation of terms

P

Protection circuit

This is a function to prevent damage to components within the power supply when an abnormality such as an overload or excess voltage occurs for any reason.

In this unit, the STANDBY indicator and protection indicator blinks and the unit enters standby mode when an abnormality occurs.

S

Speaker impedance

This is certain-rated resistance of the speaker set to an alternating current and expressed in ohms.

The smaller the impedance, the greater the output.

However, load on the amplifier is increased. Use speakers whose impedance is supported by this unit.

Troubleshooting

If a problem should arise, first check the following:

1. Are the connections correct?
2. Is the set being operated as described in the user guide?
3. Are the other components operating properly?

If this unit does not operate properly, check the items listed in the table below. Should the problem persist, there may be a malfunction. In this case, disconnect the power immediately and contact your store of purchase.

Symptom	Cause/Solution	Page
The power does not switch on. Or, the power switches off immediately after being switched on.	<ul style="list-style-type: none"> • Check that the power plug is inserted correctly in the wall socket. • The protective circuit has operated. In this case, remove the power plug from the wall socket, and wait for at least 1 minute before inserting it in the wall socket again. 	7 7, 10
There is no sound from the speakers.	<ul style="list-style-type: none"> • Check the speaker connections and connections to the other devices. • Alter the input selector to match the input connector (BALANCED or UNBALANCED) of the connected device. 	6 4
The power suddenly switches off during use, and the STANDBY indicator and protection indicator flash at approximately 0.5 second intervals.	<ul style="list-style-type: none"> • The internal temperature of the unit has increased, causing the protective circuit to operate. Remove the power plug from the wall socket, wait until the temperature of the unit has dropped adequately, and then insert the power plug back into the wall socket. • Install this unit in a well-ventilated location. • Use speakers that have the specified impedance. • If the two core wires of the speaker cables are touching, or if a core wire is out of the terminal causing the core wire to touch the rear panel of this unit, the protective circuit will operate. Remove the power plug from the wall socket, and firmly re-insert the core wire, or fix the terminal before reconnecting it. • Turn the volume down on the amp connected to this unit, and insert the power plug again. 	– – 4 4, 10 –
When the power switches off suddenly during use, the STANDBY indicator flash at approximately 0.1 second intervals and protection indicator flash at approximately 0.5 second intervals.	<ul style="list-style-type: none"> • The protective circuit has operated. In this case, remove the power plug from the wall socket, re-examine the installation conditions of this unit, and check the speaker cable connections. If the same situation occurs when the power is switched on again, contact the Marantz Service Center. 	6, 7, 10

Specifications

MM7055

Rated power output (from 20 Hz to 20 kHz/THD = 0.08 %, two channels driven):	140 W/ch, 8 Ω 170 W/ch, 6 Ω
Maximum effective output power (from 1 kHz, two channels driven):	210 W/ch, 6 Ω
Output bandwidth (8 Ω load, 0.09 %):	5 Hz – 40 kHz
Frequency response (1 W, 8 Ω):	8 Hz – 100 kHz (±3 dB)
Damping factor:	100
Input sensitivity/impedance:	1.2 V / 22 kΩ (UNBALANCED) 2.4 V / 30 kΩ (BALANCED)
Signal-to-noise ratio (IHF-A):	105 dB
Voltage amplification level:	29 dB
Supply voltage:	AC 230 V, 50 Hz
Power consumption:	660 W
Standby power:	0.2 W
Maximum external dimensions:	440 (W) x 183 (H) x 384 (D) mm
Weight:	15.7 kg

MM7025

Rated power output (from 20 Hz to 20 kHz, two channels driven):	140 W/ch, 8 Ω 170 W/ch, 6 Ω
Maximum effective output power (from 1 kHz, two channels driven):	210 W/ch, 6 Ω
Output bandwidth (8 Ω load, 0.09 %):	5 Hz – 40 kHz
Frequency response (1 W, 8 Ω):	8 Hz – 100 kHz (±3 dB)
Damping factor:	100
Input sensitivity/impedance:	1.2 V / 22 kΩ (UNBALANCED) 2.4 V / 30 kΩ (BALANCED)
Signal-to-noise ratio (IHF-A):	105 dB
Voltage amplification level:	29 dB
Supply voltage:	AC 230 V, 50 Hz
Power consumption:	330 W
Standby power:	0.2 W
Maximum external dimensions:	440 (W) x 126 (H) x 352 (D) mm
Weight:	10.8 kg

For purposes of improvement, specifications and design are subject to change without notice.

Index

Numerics

2ch playback	5
5.1ch surround playback	5
7.1ch surround playback	5
9.1ch surround playback	5

A

Accessories	1
Audio cable	4
Auto standby function	9

B

Balanced cable	4
----------------	---

C

Condensation	2
Connection	
Power cord	7
Connections	
Balanced	6
External control device	8
Power cord	7
Remote control	7
Unbalanced	6

E

Example connection variation	5
------------------------------	---

F

For expanding to front height speakers or front wide speakers	5
Front panel	3
Front speaker upgrade	5

P

Protection circuit	10
--------------------	----

R

Rear panel	3
------------	---

S

Speaker cable	4
Speaker impedance	10
Switches the connected input connectors	4
Switching the illumination lamp ON/OFF	9

T

Troubleshooting	10
Turning the Power On	9
Turning the power standby	9

X

XLR connector PIN arrangement	4
-------------------------------	---



Dimensions / Dimensions / Dimensions / Abmessungen / Dimensioni / Afmetingen / Storlek

MM7055

Unit : mm (in)

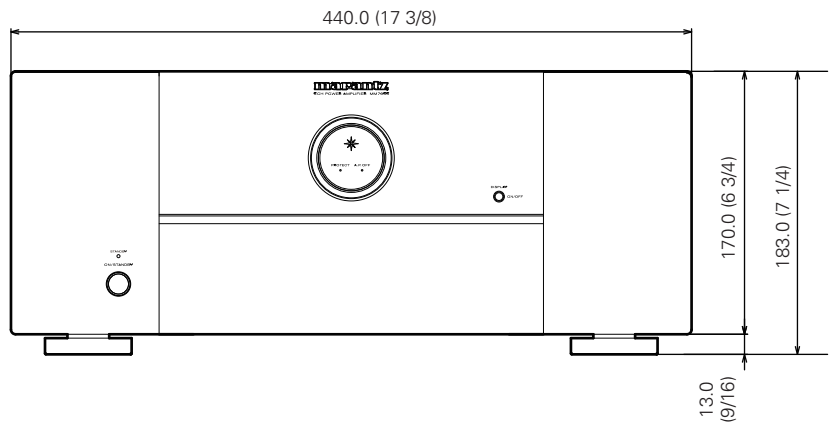
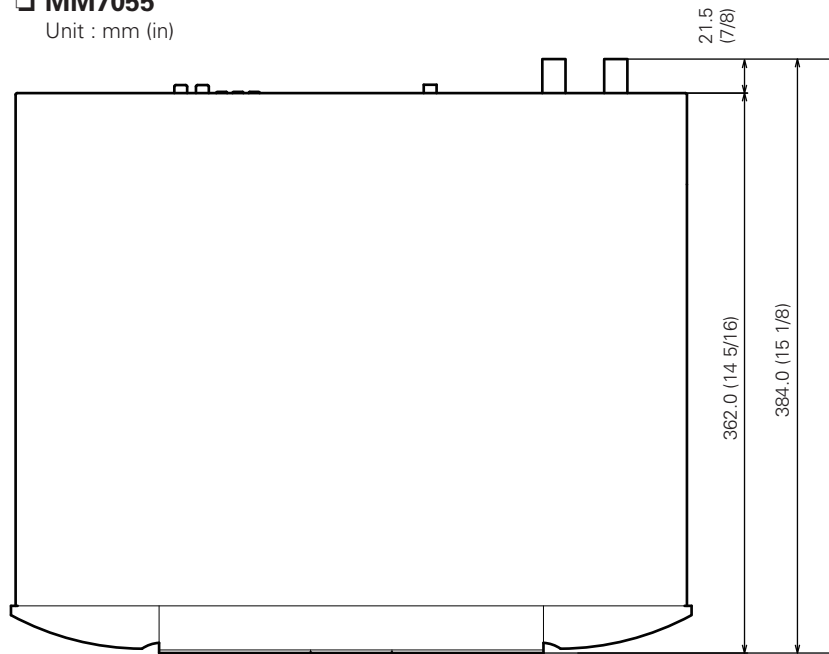

MM7025

Unit : mm (in)

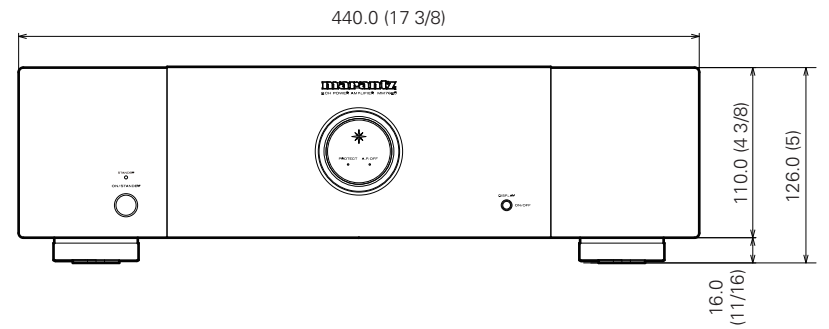
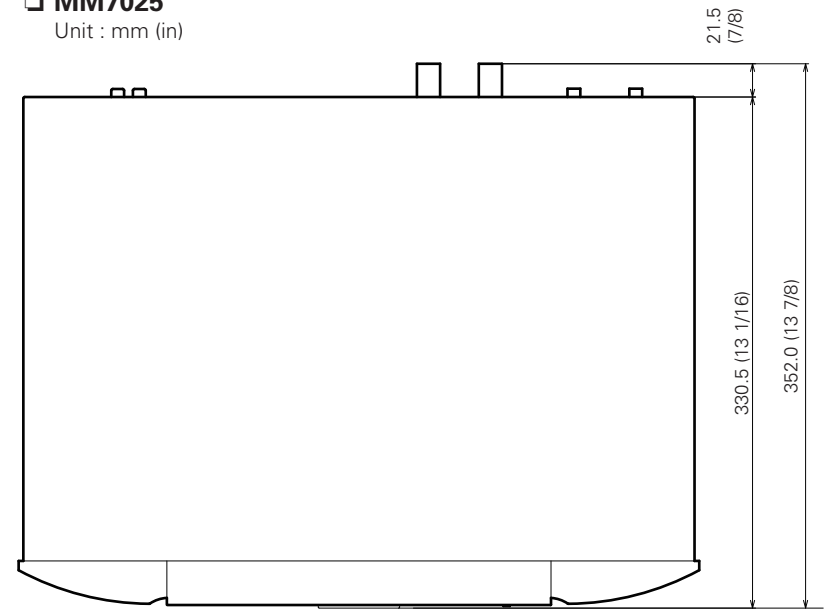

www.marantz.com

You can find your nearest authorized distributor or dealer on our website.

marantz[®] is a registered trademark.