

Nikon

DIGITAL CAMERA

1 s2

Reference Manual

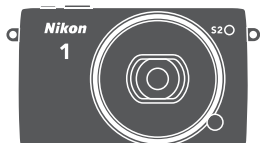

1

En

To get the most from your camera, please be sure to read all instructions thoroughly and keep them where they will be read by all who use the product.

Camera Settings

The explanations in this manual assume that default settings are used.

Symbols and Conventions

To make it easier to find the information you need, the following symbols and conventions are used:



This icon marks cautions; information that should be read before use to prevent damage to the camera.



This icon marks notes; information that should be read before using the camera.































This icon marks references to other pages in this manual.

The ▲, ▼, ◀, and ▶ symbols represent up, down, left, and right on the multi selector.

For Your Safety

Before using the camera for the first time, read the safety instructions in “For Your Safety” (□ x–xii).

1 s2

Getting the Most from Your Camera	 ii
Table of Contents	 iv
 Introduction	 1
 Taking and Viewing Photographs	 22
 Recording and Viewing Movies	 45
 Other Shooting Modes	 54
 More on Photography	 69
 More on Playback	 85
 Connections	 96
 The Playback Menu	 110
 The Shooting Menu	 121
 The Movie Menu	 143
 The Image Processing Menu	 148
 The Setup Menu	 162
 Technical Notes	 171

Getting the Most from Your Camera

Take photos with the shutter-release button.

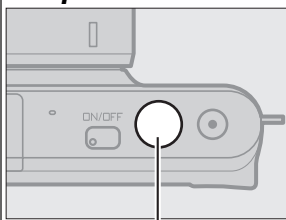

Shutter-release button

See page 7 for more information.

Shoot movies with the movie-record button.

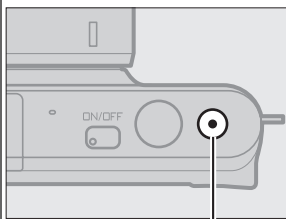

Movie-record button

Movies can be recorded by pressing the movie-record button in auto (📖 22), creative (📖 32), and advanced movie (📖 45) modes.

Download pictures to a computer.

Install the supplied software (📖 96), and **copy** photos and movies to your computer using ViewNX 2 (📖 100).

View pictures in high definition.

Use an HDMI cable to **connect the camera to an HDTV** (📖 103).

Accessories

Expand your photographic horizons with a wide variety of interchangeable lenses and other accessories (📖 171).



Lenses



Wireless mobile adapters



Software for Nikon digital cameras (available on CD)



Mount adapters

Waterproof cases

Table of Contents

Getting the Most from Your Camera	ii
Accessories	iii
For Your Safety.....	x
Notices.....	xiii
Introduction	1
Before You Begin	1
Parts of the Camera.....	2
First Steps.....	10
Taking and Viewing Photographs	22
Point-and-Shoot Photography (Auto Mode)	22
Viewing Photographs	25
Deleting Pictures	26
Live Image Control.....	30
Choosing a Creative Mode.....	32
Choosing a Mode That Matches the Subject or Situation.....	33
Taking Photos in P , S , A , and M Modes	35
The Creative Palette	41
HDR	42
Selective Color.....	43
Cross Process	44
Recording and Viewing Movies	45
Recording Movies.....	45
Taking Photographs During Movie Recording.....	50
Viewing Movies.....	51
Deleting Movies.....	52

Other Shooting Modes **54**

- ☒ **Choosing the Moment (Best Moment Capture)** 54
 - Choosing a Shot Manually (Active Selection)..... 54
 - Letting the Camera Choose the Moment (Smart Photo Selector)..... 58
- ☑ **Combining Photos with Brief Movie Vignettes (Motion Snapshot Mode)** 64
 - Viewing Motion Snapshots 68
 - Deleting Motion Snapshots 68

More on Photography **69**

- Continuous Mode**..... 69
- Self-Timer Modes** 71
- Exposure Compensation** 73
- The Built-in Flash**..... 74
 - Auto Pop-up Modes..... 74
 - Manual Pop-up Modes 76
- The WU-1a Wireless Mobile Adapter**..... 80
 - Uploading Pictures to a Smart Device 82

More on Playback **85**

- Photo Information** 85
- Thumbnail Playback**..... 88
- Calendar Playback** 89
- Playback Zoom** 90
- Deleting Pictures** 91
 - Deleting the Current Picture 91
 - The Playback Menu 91
- Rating Pictures**..... 92
- Slide Shows** 93

Connections	96
Installing the Supplied Software	96
System Requirements.....	98
Viewing and Editing Pictures on a Computer	100
Transferring Pictures	100
Viewing Pictures	102
Viewing Pictures on TV	103
High-Definition Devices.....	103
Printing Photographs	105
Connecting the Printer.....	105
Printing Pictures One at a Time.....	106
Printing Multiple Pictures.....	108
Creating a DPOF Print Order: Print Set	109
The Playback Menu	110
Selecting Multiple Images.....	112
Image Review	113
Rotate Tall	113
Protect	113
Rating	113
D-Lighting	114
Resize	115
Crop	116
Face-Priority Zoom	117
Edit Movie	117
Combine 4-Second Movies	119
Combine NMS Movies	120

The Shooting Menu	121
Reset Shooting Options	124
Exposure Mode	124
Image Quality	125
Image Size	125
Active Selection	127
Number of Shots Saved	127
Movie Before/After	128
File Format	129
Soft	129
Toy Camera Effect	130
Metering	130
Auto Distortion Control	131
Active D-Lighting	132
Long Exposure NR	133
Optical VR	133
Electronic VR	134
Focus Mode	134
Manual Focus	136
AF-Area Mode	138
Focus Lock	139
Face-Priority	140
Built-in AF Assist	140
Flash Control	141
Flash Compensation	142
Underwater Flash	142

The Movie Menu	143
Reset Movie Options.....	145
Slow Motion.....	145
Frame Size/Frame Rate.....	146
Movie Sound Options	147
Auto Image Capture.....	147
The Image Processing Menu	148
Reset Processing Options	149
White Balance.....	149
Fine-Tuning White Balance	150
Preset Manual.....	151
ISO Sensitivity	154
Picture Control.....	155
Modifying Picture Controls.....	155
Custom Picture Control.....	159
Edit/Save.....	159
Load from/Save to Card.....	160
High ISO Noise Reduction.....	161
The Setup Menu	162
Reset Setup Options	164
Format Memory Card.....	164
Slot Empty Release Lock	164
Display.....	165
Display Brightness	165
Grid Display	165
Shooting.....	165
Playback.....	165
Silent Photography.....	166
Sound Settings.....	166
Auto Power Off.....	166

Shutter Button AE Lock.....	166
Flicker Reduction.....	167
Reset File Numbering.....	167
Time Zone and Date	168
Language	168
Auto Image Rotation	169
Pixel Mapping.....	170
Firmware Version	170
Technical Notes	171
Optional Accessories	171
Approved Memory Cards.....	173
Attaching a Power Connector and AC Adapter.....	174
Storage and Cleaning	176
Storage	176
Cleaning.....	176
Caring for the Camera and Battery: Cautions	177
Available Settings	181
Defaults	183
Memory Card Capacity	184
Troubleshooting	186
Battery/Display	186
Shooting (All Modes).....	187
Shooting (P, S, A, and M Modes).....	188
Movies.....	188
Playback	189
Miscellaneous	189
Error Messages	190
Specifications	193
Nikon 1 S2 Digital Camera.....	193
Battery Life	209
Index	210

For Your Safety

To prevent damage to your Nikon product or injury to yourself or to others, read the following safety precautions in their entirety before using this equipment. Keep these safety instructions where all those who use the product will read them.

The consequences that could result from failure to observe the precautions listed in this section are indicated by the following symbol:



This icon marks warnings. To prevent possible injury, read all warnings before using this Nikon product.

■ WARNINGS

- ⚠ **Keep the sun out of the frame.** Keep the sun well out of the frame when shooting backlit subjects. Sunlight focused into the camera when the sun is in or close to the frame could cause a fire.
- ⚠ **Turn off immediately in the event of malfunction.** Should you notice smoke or an unusual smell coming from the equipment or AC adapter (available separately), unplug the AC adapter and remove the battery immediately, taking care to avoid burns. Continued operation could result in injury. After removing the battery, take the equipment to a Nikon-authorized service center for inspection.
- ⚠ **Do not use in the presence of flammable gas.** Do not use electronic equipment in the presence of flammable gas, as this could result in explosion or fire.
- ⚠ **Keep dry.** Do not immerse in or expose to water or handle with wet hands. Failure to keep the product dry could result in damage to the product, fire, or electric shock, while handling the product with wet hands could result in electric shock.
- ⚠ **Do not disassemble.** Touching the product's internal parts could result in injury. In the event of malfunction, the product should be repaired only by a qualified technician. Should the product break open as the result of a fall or other accident, remove the battery and/or AC adapter and then take the product to a Nikon-authorized service center for inspection.
- ⚠ **Keep out of reach of children.** Failure to observe this precaution could result in injury. In addition, note that small parts constitute a choking hazard. Should a child swallow any part of this equipment, consult a physician immediately.
- ⚠ **Do not place the strap around the neck of an infant or child.** Placing the camera strap around the neck of an infant or child could result in strangulation.

- ⚠ Follow the instructions of airline and hospital personnel.** This camera transmits radio frequencies that could interfere with medical equipment or aircraft navigation. Disable the wireless network feature and remove all wireless accessories from the camera before boarding an aircraft, and turn the camera off during take off and landing. In medical facilities, follow staff instructions regarding the use of wireless devices.
- ⚠ Do not remain in contact with the camera, battery, or charger for extended periods while the devices are on or in use.** Parts of the device become hot. Leaving the device in direct contact with the skin for extended periods may result in low-temperature burns.
- ⚠ Do not leave the product where it will be exposed to extremely high temperatures, such as in an enclosed automobile or in direct sunlight.** Failure to observe this precaution could cause damage or fire.
- ⚠ Do not aim the flash at the operator of a motor vehicle.** Failure to observe this precaution could result in accidents.
- ⚠ Observe caution when using a flash.**
- Using the camera with the flash in close contact with the skin or other objects could cause burns.
 - Using a flash close to the subject's eyes could cause temporary visual impairment. The flash should be no less than one meter (3 ft 4 in.) from the subject. Particular care should be observed when photographing infants.
- ⚠ Avoid contact with liquid crystal.** Should the display break, care should be taken to avoid injury due to broken glass and to prevent the liquid crystal from the display touching the skin or entering the eyes or mouth.
- ⚠ Do not carry tripods with a lens or camera attached.** You could trip or accidentally strike others, resulting in injury.
- ⚠ Observe proper precautions when handling batteries.** Batteries may leak or explode if improperly handled. Observe the following precautions when handling batteries for use in this product:
- Use only batteries approved for use in this equipment.
 - Do not short or disassemble the battery.
 - Be sure the product is off before replacing the battery. If you are using an AC adapter, be sure it is unplugged.
 - Do not attempt to insert the battery upside down or backwards.
 - Do not expose the battery to flame or to excessive heat.
 - Do not immerse in or expose to water.
 - Replace the terminal cover when transporting the battery. Do not transport or store the battery with metal objects such as necklaces or hairpins.
 - Batteries are prone to leakage when fully discharged. To avoid damage to the product, be sure to remove the battery when no charge remains.

- When the battery is not in use, attach the terminal cover and store in a cool, dry place.
 - The battery may be hot immediately after use or when the product has been used on battery power for an extended period. Before removing the battery turn the camera off and allow the battery to cool.
 - Discontinue use immediately should you notice any changes in the battery, such as discoloration or deformation.
- ⚠ **Use appropriate cables.** When connecting cables to the input and output jacks, use only the cables provided or sold by Nikon for the purpose to maintain compliance with product regulations.
- ⚠ **CD-ROMs:** CD-ROMs containing software or manuals should not be played back on audio CD equipment. Playing CD-ROMs on an audio CD player could cause hearing loss or damage the equipment.

⚠ **Observe proper precautions when handling the charger:**

- Keep dry. Failure to observe this precaution could result in injury or product malfunction due to fire or electric shock.
- Do not short the charger terminals. Failure to observe this precaution could result in overheating and damage to the charger.
- Dust on or near the metal parts of the plug should be removed with a dry cloth. Continued use could result in fire.
- Do not go near the charger during thunderstorms. Failure to observe this precaution could result in electric shock.
- Do not handle the plug or charger with wet hands. Failure to observe this precaution could result in injury or product malfunction due to fire or electric shock.
- Do not use with travel converters or adapters designed to convert from one voltage to another or with DC-to-AC inverters. Failure to observe this precaution could damage the product or cause overheating or fire.

Notices

- No part of the manuals included with this product may be reproduced, transmitted, transcribed, stored in a retrieval system, or translated into any language in any form, by any means, without Nikon's prior written permission.
- Nikon reserves the right to change the specifications of the hardware and software described in these manuals at any time and without prior notice.
- Nikon will not be held liable for any damages resulting from the use of this product.
- While every effort has been made to ensure that the information in these manuals is accurate and complete, we would appreciate it were you to bring any errors or omissions to the attention of the Nikon representative in your area (address provided separately).

Notice for Customers in Canada

CAN ICES-3 B / NMB-3 B

Notice for Customers in Europe

CAUTION: RISK OF EXPLOSION IF BATTERY IS REPLACED BY AN INCORRECT TYPE. DISPOSE OF USED BATTERIES ACCORDING TO THE INSTRUCTIONS.

This symbol indicates that electrical and electronic equipment is to be collected separately.



The following apply only to users in European countries:

- This product is designated for separate collection at an appropriate collection point. Do not dispose of as household waste.
- Separate collection and recycling helps conserve natural resources and prevent negative consequences for human health and the environment that might result from incorrect disposal.
- For more information, contact the retailer or the local authorities in charge of waste management.

This symbol on the battery indicates that the battery is to be collected separately.



The following apply only to users in European countries:

- All batteries, whether marked with this symbol or not, are designated for separate collection at an appropriate collection point. Do not dispose of as household waste.
- For more information, contact the retailer or the local authorities in charge of waste management.

Notice for Customers in the U.S.A.

The Battery Charger

IMPORTANT SAFETY INSTRUCTIONS—SAVE THESE INSTRUCTIONS

DANGER—TO REDUCE THE RISK OF FIRE OR ELECTRIC SHOCK, CAREFULLY FOLLOW THESE INSTRUCTIONS

For connection to a supply not in the U.S.A., use an attachment plug adapter of the proper configuration for the power outlet if needed. This power unit is intended to be correctly oriented in a vertical or floor mount position.

Federal Communications Commission (FCC) Radio Frequency Interference Statement

This equipment has been tested and found to comply with the limits for a Class B digital device, pursuant to Part 15 of the FCC rules. These limits are designed to provide reasonable protection against harmful interference in a residential installation. This equipment generates, uses, and can radiate radio frequency energy and, if not installed and used in accordance with the instructions, may cause harmful interference to radio communications. However, there is no guarantee that interference will not occur in a particular installation. If this equipment does cause harmful interference to radio or television reception, which can be determined by turning the equipment off and on, the user is encouraged to try to correct the interference by one or more of the following measures:

- Reorient or relocate the receiving antenna.
- Increase the separation between the equipment and receiver.
- Connect the equipment into an outlet on a circuit different from that to which the receiver is connected.
- Consult the dealer or an experienced radio/television technician for help.



Nikon
1 S2

CAUTIONS

Modifications

The FCC requires the user be notified that any changes or modifications made to this device that are not expressly approved by Nikon Corporation may void the user's authority to operate the equipment.

Interface Cables

Use the interface cables sold or provided by Nikon for your equipment. Using other interface cables may exceed the limits of Class B Part 15 of the FCC rules.

Notice for Customers in the State of California

WARNING: Handling the cord on this product may expose you to lead, a chemical known to the State of California to cause birth defects or other reproductive harm. *Wash hands after handling.*

Nikon Inc., 1300 Walt Whitman Road,
Melville, New York 11747-3064, U.S.A.
Tel.: 631-547-4200

Notice Concerning Prohibition of Copying or Reproduction

Note that simply being in possession of material that has been digitally copied or reproduced by means of a scanner, digital camera, or other device may be punishable by law.

- **Items prohibited by law from being copied or reproduced**
- **Cautions on certain copies and reproductions**

Do not copy or reproduce paper money, coins, securities, government bonds, or local government bonds, even if such copies or reproductions are stamped "Sample."

The copying or reproduction of paper money, coins, or securities which are circulated in a foreign country is prohibited.

Unless the prior permission of the government has been obtained, the copying or reproduction of unused postage stamps or post cards issued by the government is prohibited.

The copying or reproduction of stamps issued by the government and of certified documents stipulated by law is prohibited.

The government has issued cautions on copies or reproductions of securities issued by private companies (shares, bills, checks, gift certificates, etc.), commuter passes, or coupon tickets, except when a minimum of necessary copies are to be provided for business use by a company. Also, do not copy or reproduce passports issued by the government, licenses issued by public agencies and private groups, ID cards, and tickets, such as passes and meal coupons.

- **Comply with copyright notices**

The copying or reproduction of copyrighted creative works such as books, music, paintings, woodcuts, prints, maps, drawings, movies, and photographs is governed by national and international copyright laws. Do not use this product for the purpose of making illegal copies or to infringe copyright laws.

Disposing of Data Storage Devices

Please note that deleting images or formatting memory cards or other data storage devices does not completely erase the original image data. Deleted files can sometimes be recovered from discarded storage devices using commercially available software, potentially resulting in the malicious use of personal image data. Ensuring the privacy of such data is the user's responsibility.

Before discarding a data storage device or transferring ownership to another person, erase all data using commercial deletion software, or format the device and then completely refill it with images containing no private information (for example, pictures of empty sky). Care should be taken to avoid injury when physically destroying data storage devices.

AVC Patent Portfolio License

THIS PRODUCT IS LICENSED UNDER THE AVC PATENT PORTFOLIO LICENSE FOR THE PERSONAL AND NON-COMMERCIAL USE OF A CONSUMER TO (I) ENCODE VIDEO IN COMPLIANCE WITH THE AVC STANDARD (“AVC VIDEO”) AND/OR (II) DECODE AVC VIDEO THAT WAS ENCODED BY A CONSUMER ENGAGED IN A PERSONAL AND NON-COMMERCIAL ACTIVITY AND/OR WAS OBTAINED FROM A VIDEO PROVIDER LICENSED TO PROVIDE AVC VIDEO. NO LICENSE IS GRANTED OR SHALL BE IMPLIED FOR ANY OTHER USE. ADDITIONAL INFORMATION MAY BE OBTAINED FROM MPEG LA, L.L.C. SEE <http://www.mpegla.com>

Temperature Warnings

The camera may become warm to the touch during use; this is normal and does not indicate a malfunction. At high ambient temperatures, after extended periods of continuous use, or after several photographs have been taken in quick succession, a temperature warning may be displayed, following which the camera will turn off automatically to minimize damage to its internal circuits. Wait for the camera to cool before resuming use.

Use Only Nikon Brand Electronic Accessories

Nikon cameras are designed to the highest standards and include complex electronic circuitry. Only Nikon brand electronic accessories (including chargers, batteries, AC adapters, and lens accessories) certified by Nikon specifically for use with this Nikon digital camera are engineered and proven to operate within the operational and safety requirements of this electronic circuitry.

The use of non-Nikon electronic accessories could damage the camera and may void your Nikon warranty. The use of third-party rechargeable Li-ion batteries not bearing the Nikon holographic seal shown at right could interfere with normal operation of the camera or result in the batteries overheating, igniting, rupturing, or leaking.



For more information about Nikon brand accessories, contact a local authorized Nikon dealer.

Use Only Nikon Brand Accessories

Only Nikon brand accessories certified by Nikon specifically for use with your Nikon digital camera are engineered and proven to operate within its operational and safety requirements. THE USE OF NON-NIKON ACCESSORIES COULD DAMAGE YOUR CAMERA AND MAY VOID YOUR NIKON WARRANTY.

Servicing the Camera and Accessories

The camera is a precision device and requires regular servicing. Nikon recommends that the camera be inspected by the original retailer or a Nikon-authorized service representative once every one to two years, and that it be serviced once every three to five years (note that fees apply to these services). Frequent inspection and servicing are particularly recommended if the camera is used professionally. Any accessories regularly used with the camera, such as lenses, should be included when the camera is inspected or serviced.

Before Taking Important Pictures

Before taking pictures on important occasions (such as at weddings or before taking the camera on a trip), take a test shot to ensure that the camera is functioning normally. Nikon will not be held liable for damages or lost profits that may result from product malfunction.

Life-Long Learning

As part of Nikon's "Life-Long Learning" commitment to ongoing product support and education, continually-updated information is available on-line at the following sites:

- **For users in the U.S.A.:** <http://www.nikonusa.com/>
- **For users in Europe and Africa:** <http://www.europe-nikon.com/support/>
- **For users in Asia, Oceania, and the Middle East:** <http://www.nikon-asia.com/>

Visit these sites to keep up-to-date with the latest product information, tips, answers to frequently-asked questions (FAQs), and general advice on digital imaging and photography. Additional information may be available from the Nikon representative in your area. For contact information, visit <http://imaging.nikon.com/>

Introduction

Before You Begin

Before using your camera for the first time, confirm that the package contains the items listed in the *User's Manual*.



Parts of the Camera

Take a few moments to familiarize yourself with camera controls and displays. You may find it helpful to bookmark this section and refer to it as you read through the rest of the manual.

The Camera Body

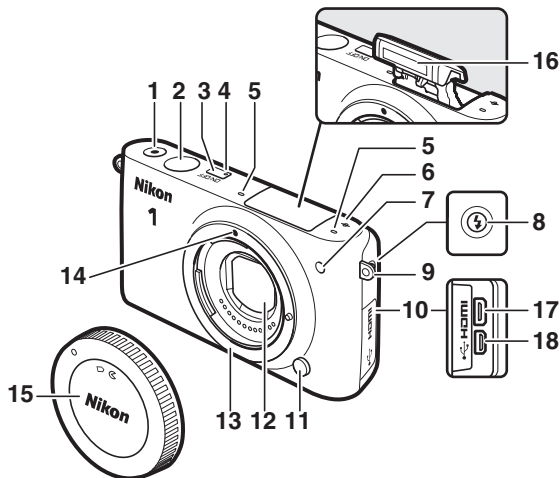

1 Movie-record button	45, 46	9 Eyelet for camera strap.....	10
2 Shutter-release button	27, 50, 56, 59, 65	10 Connector cover	
3 Power switch.....	17	11 Lens release button.....	16
4 Power lamp	17	12 Dust shield.....	176, 177
5 Microphone.....	147	13 Lens mount	15, 137
6 Focal plane mark (☉).....	137	14 Mounting mark	15
7 AF-assist illuminator	140	15 Body cap	172
Self-timer lamp.....	72	16 Built-in flash.....	74
Red-eye reduction lamp	75, 77	17 HDMI connector	103
8 Flash pop-up button.....	76	18 USB connector.....	80, 100, 105

The Camera Body (Continued)

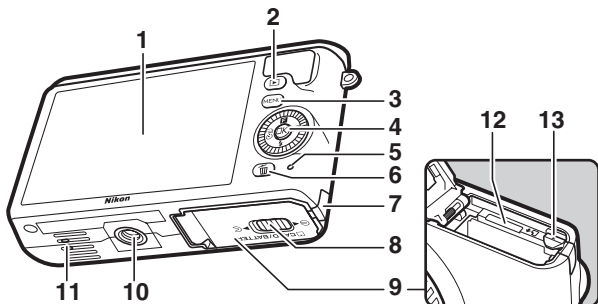

1 Monitor4, 85, 165	6 (delete) button..... 26, 91
2 (playback) button25, 62, 68	7 Power connector cover for optional power connector 174
3 MENU (menu) button 6	8 Battery-chamber/memory card slot cover latch..... 12, 14, 174
4 Multi selector.....5	9 Battery-chamber/ memory card slot cover ... 12, 14, 174
5 (OK) button.....5	10 Tripod socket *
6 (feature)9	11 Speaker
7 (exposure compensation).....73	12 Memory card slot..... 12
8 (flash mode).....74	13 Battery latch..... 12, 14, 174
9 (continuous shooting/ self-timer)..... 69, 71	
5 Memory card access lamp 14, 24	

* Camera does not support TA-N100 tripod mounting spacer.

Holding the Camera

When framing photographs, hold the camera as shown below.

*Hold the camera in
your right hand.*

*Keep your elbows
propped lightly
against your torso.*

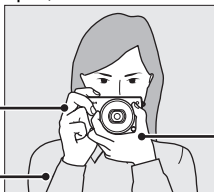

*Cradle the lens with
your left hand.*

The Monitor

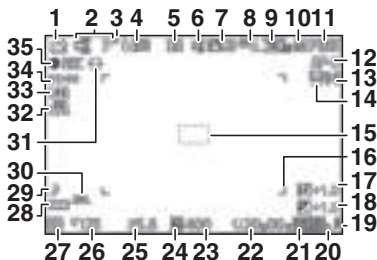

1 Shooting mode 7	20 "k" (appears when memory remains for over 1000 exposures) 21
2 Live image control 30	21 Number of exposures remaining 21
Creative mode 32	Number of shots remaining before memory buffer fills 70
Best moment capture selection 54, 58	White balance recording indicator 152
Advanced movie selection 45, 48	Card warning indicator 164, 190
Exposure mode 124	22 Time available 46
3 Flexible program indicator 35	23 ISO sensitivity 154
4 Flash mode 75, 77	24 ISO sensitivity indicator 154
5 Self-timer 71	Auto ISO sensitivity indicator 154
Continuous mode * 69	25 Aperture 37, 38
6 Active D-Lighting * 132	26 Shutter speed 36, 38
7 Picture Control * 155	27 Metering 130
8 White balance * 149	28 Battery indicator * 21
9 Frame size/frame rate 146	29 Sound settings * 166
10 Image size * 125	30 Autoexposure (AE) lock indicator 166
11 Image quality * 125	31 Auto distortion control 131
12 Focus mode * 134	32 Auto image capture 147
13 AF-area mode * 138	33 Microphone sensitivity * 147
14 Face-priority * 28, 140	34 Time elapsed 46
15 Focus area 23, 138	35 Recording indicator 46
16 AF-area brackets * 134	
17 Flash compensation 142	
18 Exposure compensation 73	
19 Flash-ready indicator 78	

* Available only when **Detailed** is selected for **Display > Shooting** in the setup menu (□ 165).

Note: Display shown with all indicators lit for illustrative purposes.

The Multi Selector

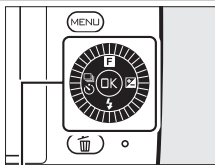

The multi selector and  button are used to adjust settings and navigate the camera menus.



Multi selector



Settings:

Access the  (feature) menu, a context-sensitive menu listing options for shooting or playback ( 9).

Menu navigation:

Move cursor up.

Settings:

View continuous shooting/self-timer menu ( 69, 71).

Menu navigation:

Return to previous menu.

Settings:

View flash mode menu ( 74, 76).

Menu navigation:

Move cursor down.

Select highlighted item.

Settings:

View exposure compensation menu ( 73).

Menu navigation:

Select highlighted item or display sub-menu.

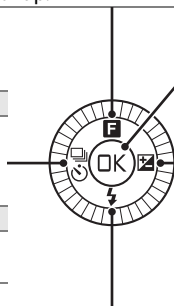

The Multi Selector

Items can be highlighted by rotating the multi selector as shown at right.



The MENU Button

The shooting mode and most shooting, playback, and setup options can be accessed from the camera menus. Press the MENU button to display the menu selection dialog shown below, then use the multi selector to highlight the icon for the desired menu and press **OK**.

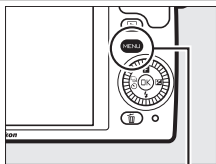

MENU button

Playback menu (📖 110):
Adjust playback settings.

Shooting menu (📖 121):
Adjust settings for still photography.

Shooting mode menu (📖 7):
Choose a shooting mode.

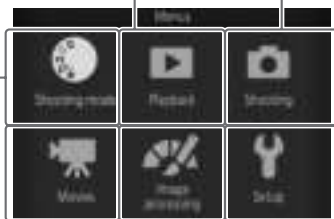

Movie menu (📖 143):
Adjust movie-recording options.

Setup menu (📖 162):
Adjust basic camera settings.

Image processing menu (📖 148):
Adjust white balance, ISO sensitivity, Picture Controls, and other image processing settings for photographs and movies.

■ Choosing a Shooting Mode

To display the shooting mode menu, press the MENU button, highlight **Shooting mode**, and press **OK**. Use the multi-selector to highlight a shooting mode and press **OK** to select the highlighted option.



📷 Motion Snapshot mode (📖 64): Each time the shutter is released, the camera records a still image and about 1.6 s of movie footage. When the resulting "Motion Snapshot" is viewed on the camera, the movie will play back in slow motion over approximately 4 s, followed by the still image.

📷 Best moment capture mode (📖 54): Choose **Active Selection** to select the best picture from ten shots in temporary storage or **Smart Photo Selector** to let the camera pick the best shot based on composition and movement.

📷 Auto mode (📖 22): Let the camera pick the settings for photographs and movies.

📷 Creative mode (📖 32): For photographs in which you want to use special effects, match settings to the scene, or control shutter speed and aperture.

📷 Advanced movie mode (📖 45): Choose an exposure mode and adjust shutter-speed or aperture or record movies in slow or fast motion or with other special effects.

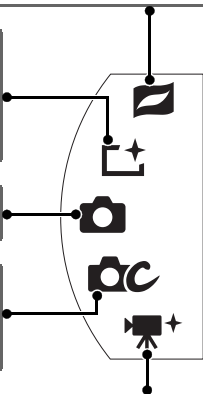

■ Using the Menus

Use the multi selector (📖 5) to navigate the playback, shooting, movie, image processing, and setup menus.

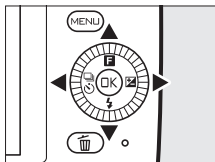

Multi selector

1 Select an item.

Press ▲ or ▼ to highlight menu items and press ▶ to view options for the highlighted item.



2 Select an option.

Press ▲ or ▼ to highlight the desired option and press **OK** to select.

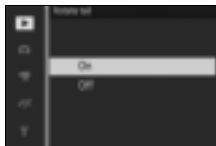

✍ Using the Menus

The items listed may vary with camera settings. Items displayed in gray are not currently available (📖 181). To exit the menus and return to shooting mode, press the shutter-release button halfway (📖 27).

✍ Choosing a Menu

To display another menu, press ◀ in Step 1 and then press ▲ or ▼ to highlight the desired icon. Press ▶ to position the cursor in the highlighted menu.

The **F** (Feature) Menu

To display the feature menu and adjust camera settings or access playback options, press **F** (feature) on the multi selector.



F menu (shooting mode)



F menu (playback)

1 Select an item.

Use the multi selector to highlight an item and press **OK** to display options (to exit the **F** menu, press the shutter-release button halfway as described on page 27 or highlight **X** and press **OK**).



2 Select an option.

Highlight the desired option or value and press **OK** to select.



The **F** Menu

The **F** menu is context-sensitive: its contents vary with camera settings or the type of image displayed; options that are currently unavailable are shown in gray. In auto mode, pressing **F** displays the shooting mode menu (□ 7).

First Steps

1 Attach the camera strap.

Attach the strap securely to the two camera eyelets.

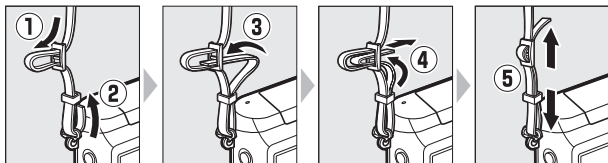

2 Charge the battery.

Insert the battery into the charger ① and plug the charger in ②. An exhausted battery fully charges in about three hours. Unplug the charger and remove the battery when charging is complete.

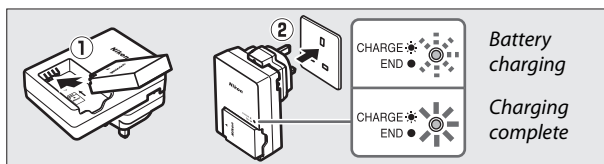

The Plug Adapter

Depending on the country or region of purchase, a plug adapter may be supplied with the charger. The shape of the adapter varies with the country or region of purchase. If a plug adapter is supplied, raise the wall plug and connect the plug adapter as shown at right, making sure the plug is fully inserted. Attempting to forcibly remove the plug adapter could damage the product.

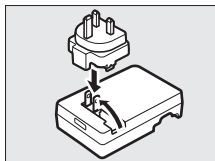

The Battery and Charger

Read and follow the warnings and cautions on pages x–xii and 177–180 of this manual. Do not use the battery at ambient temperatures below 0°C (32°F) or above 40°C (104°F); failure to observe this precaution could damage the battery or impair its performance. Capacity may be reduced and charging times may increase at battery temperatures from 0°C (32°F) to 10°C (50°F) and from 45°C (113°F) to 60°C (140°F); the battery will not charge if its temperature is below 0°C (32°F) or above 60°C (140°F).

Charge the battery at ambient temperatures between 5°C (41°F) and 35°C (95°F). If the **CHARGE** lamp flashes quickly during charging, cease use immediately and take battery and charger to your retailer or a Nikon-authorized service representative.

Do not move the charger or touch the battery during charging. Failure to observe this precaution could in very rare instances result in the charger showing that charging is complete when the battery is only partially charged. Remove and reinsert the battery to begin charging again.

Use the charger with compatible batteries only. Unplug when not in use.



3 Insert the battery and a memory card.

The camera stores pictures on microSD, microSDHC, and microSDXC memory cards (available separately;  173). Before inserting the battery or memory cards, check that they are in the correct orientation. Using the battery to keep the orange battery latch pressed to one side, slide the battery in until it latches, and then slide in the memory card until it clicks into place. Do not attempt to insert the card at an angle; failure to observe this precaution could damage the product.

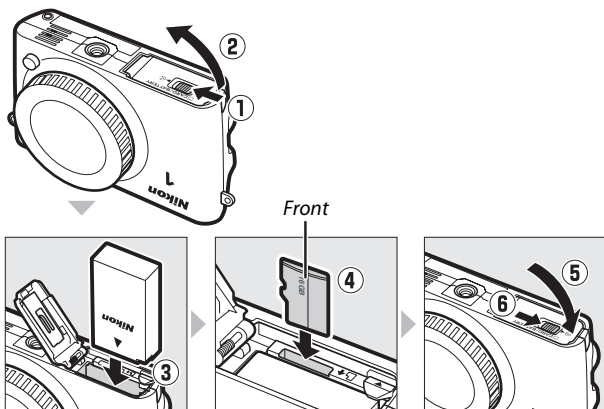

✔ Inserting and Removing Batteries and Memory Cards

Always turn the camera off before inserting or removing batteries or memory cards. Note that the battery and memory cards may be hot after use; observe due caution when removing the battery and memory cards.

✍ Formatting Memory Cards

If this is the first time the memory card will be used in the camera or if the card has been formatted in another device, select **Format memory card** in the setup menu and follow the on-screen instructions to format the card (□ 164). *Note that this permanently deletes any data the card may contain.* Be sure to copy any photographs and other data you wish to keep to a computer before proceeding.

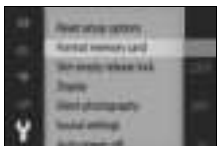

Removing Batteries and Memory Cards

After turning the camera off, confirm that the memory card access lamp (📄 3) is off and open the battery-chamber/memory card slot cover. To remove the battery, first release it by pressing the orange battery latch in the direction shown by the arrow and then remove the battery by hand.

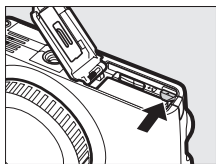

To remove a memory card, first press the card in to eject it (1); the card can then be removed by hand (2). Care should be taken to prevent the card popping from the camera when ejected.

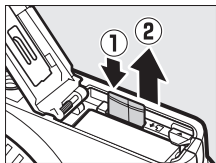

Memory Cards

- Do not remove memory cards from the camera, turn the camera off, or remove or disconnect the power source during formatting or while data are being recorded, deleted, or copied to a computer. Failure to observe these precautions could result in loss of data or in damage to the camera or card.
- Do not touch the card terminals with your fingers or metal objects.
- Do not bend, drop, or subject to strong physical shocks.
- Do not apply force to the card casing. Failure to observe this precaution could damage the card.
- Do not expose to water, heat, high levels of humidity, or direct sunlight.
- Do not format memory cards in a computer.

4 Attach a lens.

Be careful to prevent dust from entering the camera when the lens or body cap is removed. The lens generally used in this manual for illustrative purposes is a 1 NIKKOR VR 10–30mm f/3.5–5.6 PD-ZOOM.

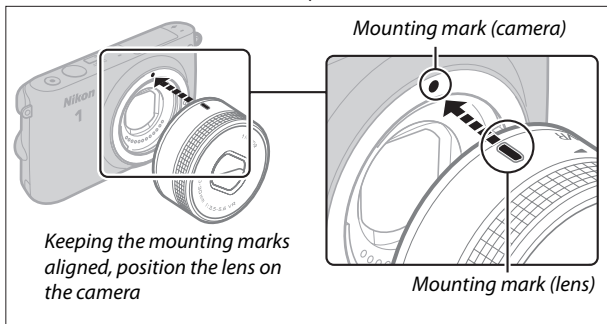
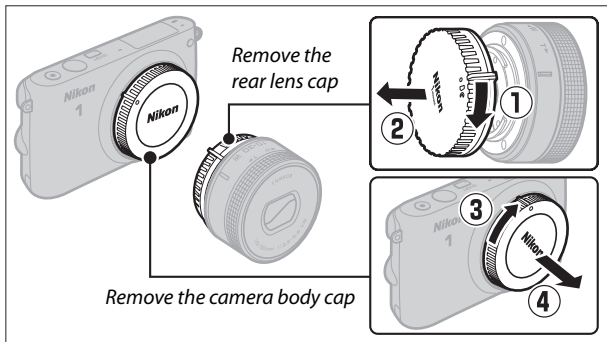

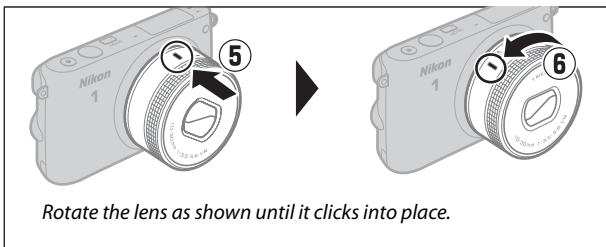

If the lens supports vibration reduction (VR), vibration reduction can be controlled from the camera (📖 133).

🔍 Detaching the Lens

Be sure the lens is retracted before removal. To remove the lens, turn the camera off, then press and hold the lens release button (1) while turning the lens clockwise (2). After removing the lens, replace the camera body cap, the rear lens cap, and, if applicable, the front lens cap.

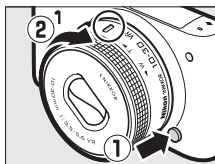

🔍 Lenses with Retractable Lens Barrel Buttons

Lenses with retractable lens barrel buttons can not be used when retracted. To unlock and extend the lens, readying the camera for use, keep the retractable lens barrel button pressed (1) while rotating the zoom ring as shown (2). The lens can be retracted and the zoom ring locked by pressing the button and rotating the ring in the opposite direction. Be careful not to press the retractable lens barrel button while attaching or removing the lens.

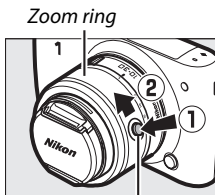

Retractable lens barrel button

5 Turn the camera on.

Press the power switch to turn the camera on. The power lamp will briefly light green and the monitor will turn on. If the lens is equipped with a front lens cap, remove the cap before shooting. If a 1 NIKKOR VR 10–30mm f/3.5–5.6 PD-ZOOM lens is attached, the lens will automatically extend when the camera is turned on and retract when the camera is turned off.

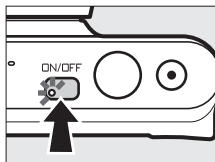

Turning the Camera Off

To turn the camera off, press the power switch again. The monitor will turn off.

Auto Power Off

If no operations are performed for about a minute, the display will turn off and the power lamp start to flash (if desired, the delay before the display turns off automatically can be changed using the **Auto power off** option in the setup menu; □ 166). The camera can be reactivated by operating the shutter-release button. If no operations are performed for about three minutes after the display has turned off, the camera will turn off automatically.



Attaching and Removing Lenses

Turn the camera off before attaching or removing lenses. Note that when the camera is turned off, the sensor protection barrier in the lens will close, protecting the camera image sensor.

Lenses with Retractable Lens Barrel Buttons

The camera will turn on automatically when the retractable lens barrel lock is released; in addition, if the view through the lens is displayed or the monitor is off, the camera will turn off when the lens barrel is locked (in the case of 1 NIKKOR VR 10–30mm f/3.5–5.6 and 1 NIKKOR VR 30–110mm f/3.8–5.6 lenses, firmware version 1.10 or later is required if locking the lens barrel is to turn the camera off when the monitor is off; for information on updating lens firmware, visit the Nikon website for your area).

6 Choose a language.



A language-selection dialog will be displayed the first time the camera is turned on. Use the multi selector and  button ( 5) to choose a language.



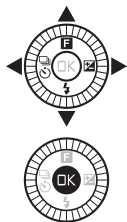

7 Set the clock.

Use the multi selector and  button (book 5) to set the time and date. *Note that the camera uses a 24-hour clock.*





Press  or  to highlight time zone and press .



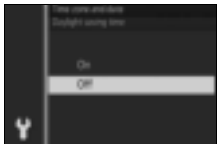



Press  or  to highlight date format and press .



Press  or  to highlight daylight saving time option and press .



Press  or  to highlight items and press  or  to change. Press  to exit to shooting display when setup is complete.

Note: Language and clock can be changed at any time using **Language** (book 168) and **Time zone and date** (book 168) options in setup menu.



 **The Camera Clock**

The camera clock is less accurate than most watches and household clocks. Check the clock regularly against more accurate time pieces and reset as necessary.

The camera clock is powered by an independent, rechargeable power source, which is charged as necessary when the main battery is installed or the camera is powered by an optional EP-5E power connector and EH-5b AC adapter (📖 174). Three days of charging will power the clock for about a month. If a message warning that the clock is not set is displayed when the camera is turned on, the clock battery is exhausted and the clock has been reset. Set the clock to the correct time and date.



8 Check the battery level and memory card capacity.

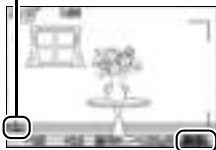

Check the battery level and number of exposures remaining in the monitor.

Battery level



Exposures remaining

■ ■ Battery Level

Display	Description
NO ICON	Battery fully charged or partially discharged; level shown by  or  icon in detailed display (☞ 165).
	Low battery. Ready fully-charged battery or prepare to charge battery.
Cannot take pictures. Insert fully-charged battery.	Battery exhausted; shutter-release disabled. Insert charged battery.

■ ■ Number of Exposures Remaining

The monitor shows the number of pictures that can be stored on the memory card at current settings (values over 1000 are rounded down to the nearest hundred; e.g., values between 1200 and 1299 are shown as 1.2 k). If a warning is displayed stating that there is not enough memory for additional images, insert another memory card (☞ 12) or delete some photos (☞ 91).



Taking and Viewing Photographs

This chapter describes how to take, view, and delete photographs in auto and creative mode.

Point-and-Shoot Photography (Auto Mode)



Follow the steps below to take photographs in auto mode, a “point-and-shoot” mode in which the camera automatically detects the subject type and adjusts settings according to the subject and situation.

1 Turn the camera on.

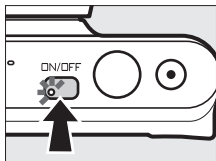
Press the power switch to turn the camera on.



2 Select mode.

Press the MENU button to display the menus. Select **Shooting mode**, then highlight  (auto) and press  (see page 7).

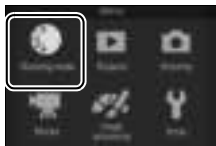

3 Ready the camera.

Hold the camera securely with both hands, being careful not to obstruct the lens, AF-assist illuminator, or microphone. Rotate the camera as shown at lower right when taking pictures in “tall” (portrait) orientation.

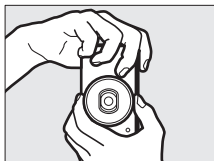
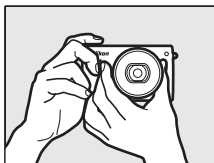

4 Frame the photograph.

Position your subject in the center of the frame.

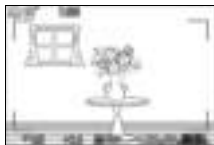

5 Focus.

Press the shutter-release button halfway to focus. If the subject is poorly lit, the flash may pop up (📖 74) and the AF-assist illuminator (📖 140) may light to assist the focus operation.



If the camera is able to focus, the selected focus area will be highlighted in green and a beep will sound (a beep may not sound if the subject is moving).

Focus area

If the camera is unable to focus, the focus area will be displayed in red.

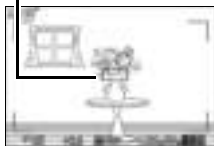

6 Shoot.

Smoothly press the shutter-release button the rest of the way down to release the shutter and record the photograph. The memory card access lamp will light and the photograph will be displayed in the monitor for a few seconds (the photo will automatically clear from the display when the shutter-release button is pressed halfway). *Do not eject the memory card or remove the battery until the lamp has gone out and recording is complete.*

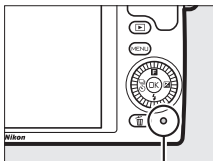
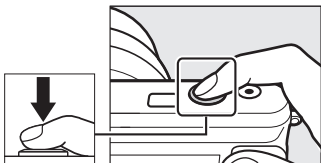

Memory card access lamp

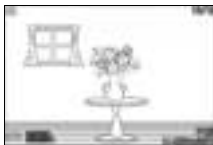

The Framing Grid

A framing grid can be displayed by selecting **On** for **Display > Grid display** in the setup menu (📖 165).

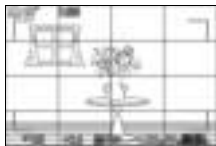

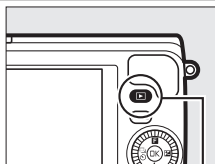

Viewing Photographs

Press  to display your most recent photograph full frame in the monitor (full-frame playback).

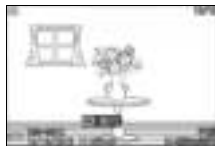

 button



Press  or  or rotate the multi selector to view additional pictures.



To end playback and return to shooting mode, press the shutter-release button halfway.

The **F** (Feature) Menu (📖 9)

The following options can be accessed by pressing **F** when a photo is displayed:

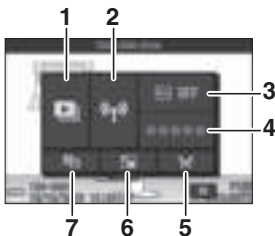

1	Start slide show	93
2	Wi-Fi upload *	82
3	Protect.....	113
4	Rating.....	113
5	Crop	116
6	Resize	115
7	D-Lighting.....	114

* Displayed when optional WU-1a wireless mobile adapter is connected.

Deleting Pictures

To delete the current picture, press . *Note that once deleted, pictures can not be recovered.*

1 Display the photograph.



Display the photograph you wish to delete as described on the preceding page.

2 Press .

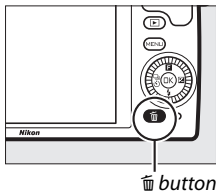
A confirmation dialog will be displayed.



3 Delete the photograph.

Press  again to delete the picture and return to playback, or press  to exit without deleting the picture.

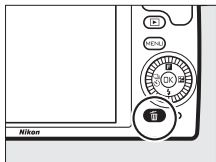

The Shutter-Release Button

The camera has a two-stage shutter-release button. The camera focuses when the shutter-release button is pressed halfway. To take the photograph, press the shutter-release button the rest of the way down.



Focus: Press halfway

Shoot: Press the rest of the way down

Taking Several Photographs in Succession





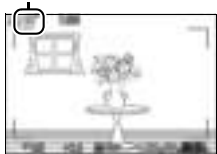

If **Off** is selected for **Image review** in the playback menu (📖 113), you can take additional photographs without refocusing by keeping the shutter-release button pressed halfway between shots.

Automatic Scene Selection

In auto mode, the camera automatically analyzes the subject and selects the appropriate scene. The selected scene is shown in the monitor.

Scene icon



	Portrait: Human portrait subjects.
	Landscape: Landscapes and cityscapes.
	Night portrait: Portrait subjects framed against dark backgrounds.
	Close up: Subjects close to the camera.
	Night landscape: Poorly-lit landscapes and cityscapes.
	Auto: Subjects that do not fall into the categories listed above.



Using a Zoom Lens

Use the zoom ring to zoom in on the subject so that it fills a larger area of the frame, or zoom out to increase the area visible in the final photograph. During movie recording with the 1 NIKKOR VR 10–30mm f/3.5–5.6 PD-ZOOM, the zoom rate is unaffected by the speed with which the ring is rotated.

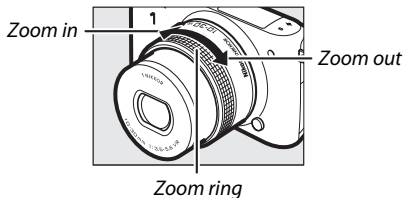

If you are using a 1 NIKKOR VR 10–100mm f/4.5–5.6 PD-ZOOM lens (available separately), slide the power drive zoom switch to **T** to zoom in and to **W** to zoom out. The speed with which the camera zooms in and out varies with how far you slide the switch. The zoom position is shown by the zoom guide in the display.

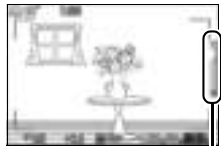

Zoom guide

Face Priority

The camera detects and focuses on portrait subjects (face priority). A double yellow border will be displayed if a portrait subject is detected facing the camera (if multiple faces, up to a maximum of five, are detected, the camera will select the closest subject). Press the shutter-release button halfway to focus on the subject in the double yellow border. The border will clear from the display if the camera can no longer detect the subject (because, for example, the subject has looked away).



Available Settings

For information on the options available in auto mode, see page 181.

Deleting Multiple Pictures

The **Delete** option in the playback menu (📖 91) can be used to delete all or selected pictures.

See Also

See page 166 for information on silencing the beep that sounds when the camera focuses or the shutter is released. For information on toggling photo info on or off, see page 165. See page 88 for information on viewing multiple images. For information on zooming in on the center of the current image, see page 90. See page 93 for information on slide shows.



Live Image Control

Live image controls let you preview how changes to each control will affect the final photograph. To choose a live image control for auto mode, press **OK** to display the live image control menu, then use the multi selector to highlight a control and press **OK** to view the effect. Rotate the multi selector to choose a setting and press **OK** to select.



Active D-Lighting: Preserve details in highlights and shadows for natural contrast.



Active D-Lighting: High

Active D-Lighting: Low

Background softening: Soften background details to make your subject stand out, or bring both background and foreground into focus.



Background sharp

Background softened

Increase effect



Reduce effect

Sharpen background



Soften background

Motion control: Suggest motion by blurring moving objects, or “freeze” motion to capture moving objects clearly.



Freeze motion



Blur motion

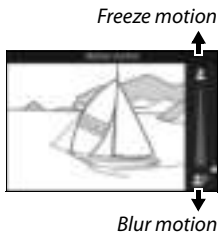

Brightness control: Make pictures brighter or darker.



Brighter



Darker

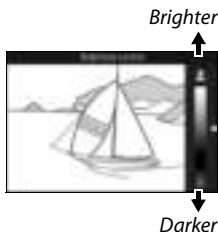

Live Image Control

Continuous shooting is not available (☐ 69) and the built-in flash can not be used when live image control is in effect. Pressing the movie-record button cancels live image control.

Choosing a Creative Mode

Choose creative mode to match settings to the subject or situation, take photos using special effects, or control shutter speed and aperture.

1 Select **CC** mode.

Press the MENU button to display the menus. Highlight **Shooting mode** and press **OK**, then highlight **CC** (creative mode) and press **OK** (☰ 7).

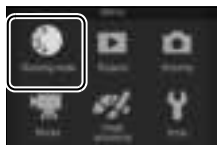

2 Choose an option.

Press **F** (feature) on the multi selector to display the **F** menu, then highlight **Creative** and press **OK**. Highlight an option suited to your subject and creative intent (☰ 33) and press **OK**.



Choosing a Mode That Matches the Subject or Situation

Choose a creative mode according to the subject or situation:

Option	Description
Programmed auto (P)	The camera sets shutter speed and aperture for optimal exposure (□ 35). Recommended for snapshots and in other situations in which there is little time to adjust camera settings.
Shutter-priority auto (S)	You choose the shutter speed; the camera selects an aperture for best results (□ 36). Use to freeze or blur motion.
Aperture-priority auto (A)	You choose the aperture; the camera selects a shutter speed for best results (□ 37). Use to blur the background or bring both foreground and background into focus.
Manual (M)	You control both shutter speed and aperture (□ 38). Choose a shutter speed of “Bulb” for long time-exposures (□ 39).
Creative Palette (C)	Rotate the palette to choose creative effects while previewing them in the display (□ 41).
HDR (HDR)	Photograph high-contrast scenes (□ 42).
Soft (O)	Shoot photographs with a soft filter effect. Use the F (feature) menu (□ 34) to select the amount of softening and to choose how softening applies to portraits (□ 129).
Miniature effect (M)	The top and bottom of each photo is blurred so that the subject appears to have been a diorama photographed at short range. Works best when shooting from a high vantage point.
Selective color (S)	Take photos in which only a selected hue appears in color (□ 43).
Cross process (C)	Choose a base color to create photographs with different hues (□ 44).
Toy camera effect (T)	Alter color saturation and reduce peripheral illumination for a toy camera effect (□ 130). The effect can be adjusted using the F menu (□ 34).



The **F** (Feature) Menu (📖 9)

Pressing **F** in creative mode displays the items listed below. The items available vary with the option selected for creative mode (📖 33).

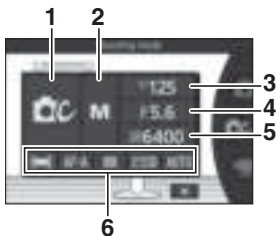

1	Shooting mode.....	7
2	Creative.....	32
3	Shutter speed.....	36, 38
4	Aperture.....	37, 38
5	ISO sensitivity.....	154
6	AF-area mode	138
	Focus mode	134
	Metering.....	130
	Picture Control.....	155
	White balance	149
	Select color	43
	Filter strength	129
	Portrait.....	129
	Hue	44
	Saturation	130
	Vignetting.....	130

Available Settings

For information on the options available in creative mode, see page 182.

Taking Photos in P, S, A, and M Modes

P, S, A, and M modes offer varying degrees of control over shutter speed and aperture. Choose a mode and adjust settings according to your creative intent.

■ P Programmed Auto

In this mode, the camera automatically adjusts shutter speed and aperture for optimal exposure in most situations. This mode is recommended for snapshots and other situations in which you want to leave the camera in charge of shutter speed and aperture.



Choosing a Combination of Shutter Speed and Aperture

Although the shutter speed and aperture chosen by the camera will produce optimal results, you can also choose from other combinations that will produce the same exposure (“flexible program”). Rotate the multi selector clockwise for large apertures (low f-numbers) that blur background details or fast shutter speeds that “freeze” motion. Rotate the multi selector counterclockwise for small apertures (high f-numbers) that increase depth of field or slow shutter speeds that blur motion. * is displayed while flexible program is in effect.

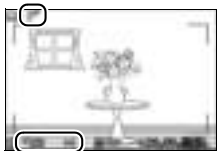

Restoring Default Shutter Speed and Aperture Settings

To restore default shutter speed and aperture settings, rotate the multi selector until * is no longer displayed or turn the camera off. The default shutter speed and aperture is automatically restored when the camera enters standby mode.

■ S Shutter-Priority Auto

In shutter-priority auto, you choose the shutter speed while the camera automatically selects the aperture that will produce the optimal exposure. Use slow shutter speeds to suggest motion by blurring moving subjects, fast shutter speeds to “freeze” motion.



Fast shutter speed (1/1600 s)



Slow shutter speed (1 s)

Choosing a Shutter Speed

Rotate the multi selector to choose from shutter speeds between 30 s and 1/16,000 s. Rotate the selector clockwise for faster shutter speeds, counterclockwise for slower shutter speeds.



Continuous Shooting

The selected shutter speed may change when a frame rate of 10 fps or faster is selected in continuous shooting mode (□ 69).

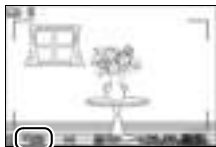

■ ■ A Aperture-Priority Auto

In aperture-priority auto, you choose the aperture while the camera automatically selects the shutter speed that will produce the optimal exposure. Large apertures (low f-numbers) reduce depth of field, blurring objects behind and in front of the main subject. Small apertures (high f-numbers) increase depth of field, bringing out details in the background and foreground. Short field depths are generally used in portraits to blur background details, long field depths in landscape photographs to bring the foreground and background into focus.



Large aperture (f/5.6)



Small aperture (f/16)

Choosing an Aperture

Rotate the multi selector counterclockwise for larger apertures (lower f-numbers), clockwise for smaller apertures (higher f-numbers). The minimum and maximum values depend on the lens currently in use.

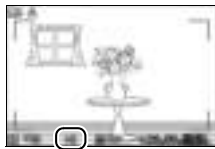

■ M Manual

In manual mode, you control both shutter speed and aperture.

Choosing Shutter Speed and Aperture

Adjust shutter speed and aperture with reference to the exposure indicator (see below). Press **▶** to highlight shutter speed or aperture and rotate the multi-selector to choose a value, then repeat for the remaining item. Rotate the selector clockwise for faster shutter speeds or smaller apertures (higher f-numbers), counterclockwise for slower shutter speeds and larger apertures (lower f-numbers). Shutter speeds can be set to values as fast as $\frac{1}{16,000}$ s or as slow as 30 s, or to “Bulb” to hold the shutter open indefinitely for a long time-exposure (☞ 39). Aperture can be set to values between the minimum and maximum for the lens.

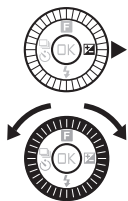

Shutter speed

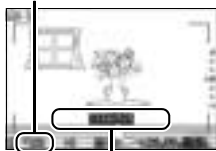

Press ▶ to highlight aperture.

Aperture

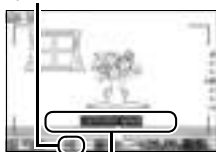

Press ▶ to highlight shutter speed.

☑ Continuous Shooting

The selected shutter speed may change when a frame rate of 10 fps or faster is selected in continuous shooting mode (☞ 69).

The Exposure Indicator

When shutter speeds other than “Bulb” are selected, the exposure indicator shows whether the photograph would be under- or over-exposed at current settings.

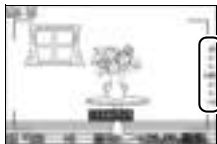

Optimal exposure	Underexposed by $\frac{1}{3}$ EV	Overexposed by over 2 EV
+ . . -0 . . -	+ . . =0 . . -	+ 0 . . . -

ISO Sensitivity (P, S, A, and M Modes)

When an “auto” option is selected for **ISO sensitivity** (□ 154), the camera will automatically adjust sensitivity within the selected range if optimal exposure can not be achieved at the selected shutter speed or aperture.



■ Long Time-Exposures (M Mode Only)

Select a shutter speed of “Bulb” for long time-exposures of moving lights, the stars, night scenery, or fireworks. The shutter remains open while the shutter-release button is held down. To prevent blur, use a tripod.



1 Ready the camera.

Mount the camera on a tripod or place it on a stable, level surface. To prevent loss of power before the exposure is complete, use a fully charged EN-EL22 battery or an optional EH-5b AC adapter and EP-5E power connector. Note that noise (bright spots, randomly-spaced bright pixels, or fog) may be present in long exposures; before shooting, choose **On** for **Long exposure NR** in the shooting menu (□ 133).

2 Choose a shutter speed of "Bulb".

Press ► to highlight shutter speed and rotate the multi-selector counterclockwise to select "Bulb".

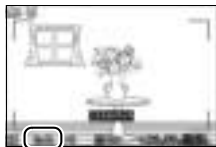
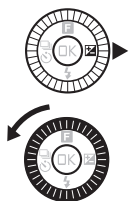

3 Open the shutter.

After focusing, press the shutter-release button all the way down. Keep the shutter-release button pressed until the exposure is complete.

4 Close the shutter.

Take your finger off the shutter-release button.

Shooting ends automatically after about two minutes. Note that some time may be required to record long exposures.

The Creative Palette

Choose a creative effect. Rotate the multi selector to choose the effect while previewing the results in the monitor. The effect changes gradually as the multi selector is rotated.

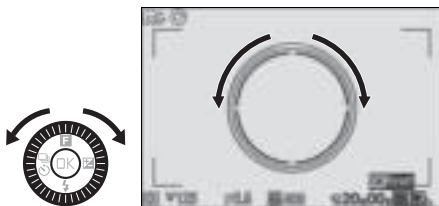

Press the shutter-release button all the way down to take a picture with the selected effect. The built-in flash can not be used.

Scene Detection

The camera automatically adjusts settings to suit the subject and situation. The effects available vary with the type of subject detected. To reset the palette, press **OK** while the creative palette is displayed.



HDR

Details in highlights and shadows are preserved using HDR (high dynamic range). Each time the shutter-release button is fully pressed, the camera takes two shots in quick succession and combines them to preserve details in highlights and shadows in high-contrast scenes; the built-in flash does not fire. Some time may be required to process the pictures; the final photograph will be displayed when processing is complete.



*First exposure
(darker)*

+



*Second exposure
(brighter)*



*Combined HDR
image*

Framing HDR Photographs

The edges of the image will be cropped out. The desired results may not be achieved if the camera or subject moves during shooting. Depending on the scene, shading may be uneven and shadows may appear around bright objects or halos around dark objects.

Selective Color

Take black-and-white pictures in which one hue appears in a color.

1 Choose **Select color**.

Press **F** to display the **F** (feature) menu, then highlight **Select color** and press **OK**.



2 Choose a color.

Use the multi selector to choose a color and press **OK**.

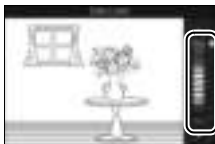

3 Take pictures.

Press the shutter-release button all the way down to take pictures. Only the selected hue will appear in color; all other hues will be recorded in shades of gray.



Cross Process

Select a base hue to take pictures with modified colors.

1 Select Hue.

Press **F** to display the **F** (feature) menu, then highlight **Hue** and press **OK**.



2 Choose a color.

Use the multi selector to choose a base color (red, green, blue, or yellow) and press **OK**.

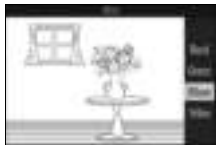

3 Take pictures.

Press the shutter-release button all the way down to take pictures with modified colors.



Recording and Viewing Movies

Recording Movies

Use the movie-record button to record movies in auto, creative, and advanced movie mode.

1 Turn the camera on.

Press the power switch to turn the camera on.

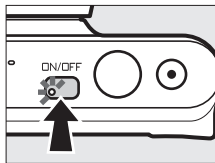

2 Choose a shooting mode.

Press the MENU button to display the menus, then highlight **Shooting mode** and press **OK**. Highlight **Auto** (auto), **C** (creative), or **M+** (advanced movie) and press **OK** (□ 7). In advanced movie mode, you can choose a movie type using the **Advanced movie** option in the **F** menu (□ 48).



3 Frame the opening shot.

Frame the opening shot with your subject in the center of the display. If **Slow motion** is selected in advanced movie mode (□ 48), press the shutter-release button halfway to focus.



The Icon

A  icon indicates that movies can not be recorded.

4 Start recording.

Press the movie-record button to begin recording. A recording indicator, the time elapsed, and the time available are displayed while recording is in progress.

Audio Recording

Be careful not to cover the microphone and note that the built-in microphone may record sounds made by the camera or lens. Except when recording slow-motion movies, the camera focuses continuously; to avoid recording focus noise, select **Single AF** for **Focus mode** in the movie menu (□ 134).

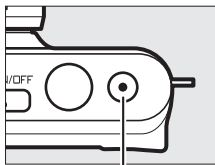

Movie-record button

*Recording indicator/
Time elapsed*

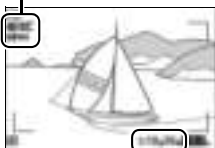

Time available

5 End recording.

Press the movie-record button again to end recording. Recording will end automatically when the maximum length is reached (□ 146), the memory card is full, the lens is removed, or the camera becomes hot (□ xvi).

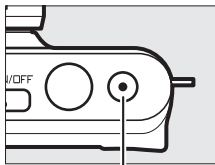

Movie-record button

Maximum Length

The camera can record movies up to 4 GB in size (for more information, see page 146); note that depending on memory card write speed, shooting may end before this length is reached (□ 173).

■ Shooting Mode

Movies can be recorded in the shooting modes listed below. Movies can not be recorded in best moment capture or Motion Snapshot modes.



📷 Auto mode (📖 22)

Choose this mode to leave the camera in charge of choosing settings. The camera automatically adjusts settings according to the subject and situation.

📷 Creative mode (📖 32)

*Record movies in exposure mode P (programmed auto). If **Creative Palette** is selected, the chosen effect will be applied to the movie (📖 41).*

📷+ Advanced movie mode (📖 48)

Choose an exposure mode (📖 124) and adjust shutter speed or aperture, or record movies in slow or fast motion or with other special effects.

🔧 Movie Sound

The **Movie sound options** item in the movie menu offers microphone sensitivity and wind noise options (📖 147).

🔧 Available Settings











For information on the options available in advanced movie mode, see page 181.



■ Advanced Movie Options

In **+** (advanced movie) mode, the following options can be accessed by pressing **F** and selecting **Advanced movie** in the **F** (feature) menu.



 HD movie	Record high-definition (HD) movies.
 Slow motion	<p>Record up to about 2 seconds of silent slow-motion footage. Slow-motion movies are recorded at 400 fps and play back at about 30 fps.</p> <p><i>Recording</i> </p> <p><i>Playback</i> </p>
 Fast motion	<p>Record silent fast-motion footage that plays back at about 4 times normal speed. Playback time is one quarter the recording time.</p> <p><i>Recording</i> </p> <p><i>Playback</i> </p>
 Jump cut	<p>Record silent jump-cut movies. Recording pauses every other second for a drop-frame effect.</p> <p><i>Recording</i> </p> <p><i>Playback</i> </p>
 4-second movie	Record a 4-second movie clip. Multiple clips can be joined into a single movie using the Combine 4-second movies option in the playback menu (□ 119).

The **F** (Feature) Menu (📖 9)

Pressing **F** in advanced movie mode displays the items listed below. The items available vary with the type of movie selected (📖 48).

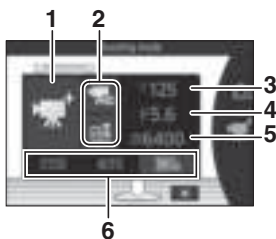

1	Shooting mode.....	7
2	Advanced movie.....	48
	Exposure mode.....	124
3	Shutter speed.....	36, 38
4	Aperture	37, 38
5	ISO sensitivity.....	154
6	Picture Control.....	155
	White balance	149
	Frame size/frame rate	146
	Slow motion	145

Slow Motion

When slow motion is selected in advanced movie mode, the camera can be focused by pressing the shutter-release button halfway before recording begins. The camera focuses on the subject at the center of the display; face detection (📖 28) is not available. Focus and exposure can not be adjusted during recording. Frame rate options are described on page 145.

Recording Time

The following table lists the approximate maximum recording times for individual movies shot at the default frame rate in each shooting mode.

Auto mode	20 minutes
Creative mode	20 minutes
Advanced movie mode	
HD movie	20 minutes
Slow motion	2 seconds
Fast motion	5 minutes
Jump cut	10 minutes
4-second movie	4 seconds



Taking Photographs During Movie Recording

Press the shutter-release button all the way down to take a photograph without interrupting movie recording. Photographs taken during movie recording have an aspect ratio of 3 : 2.

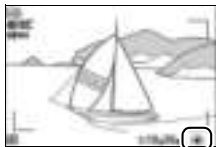

Taking Photographs During Movie Recording

Up to 10 photographs can be taken with each movie shot. Please note that photographs can not be taken with slow-motion movies.



Focus Lock

If **Single AF** is selected for **Focus mode** in the movie menu for advanced movie mode, focus will lock while the shutter-release button is pressed halfway ( 139).

See Also







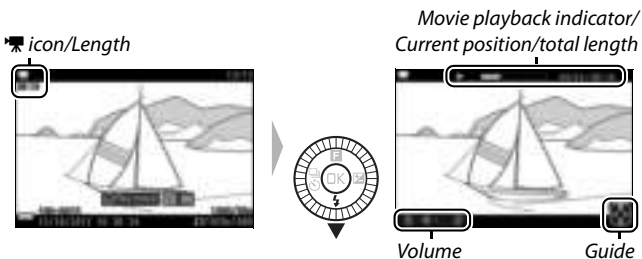



See page 147 for information on configuring the camera to take photographs automatically during movie recording.

Viewing Movies

Movies are indicated by a  icon in full-frame playback (25). Press  to start playback.



The following operations can be performed:

To	Use	Description
Pause		Pause playback.
Play		Resume playback when the movie is paused or during rewind/advance.
Advance/ rewind		Press  to rewind,  to advance. Speed increases with each press, from 2x to 4x to 8x to 16x. If playback is paused, the movie rewinds or advances one frame at a time; keep the button pressed for continuous rewind or advance.
Adjust volume		Rotate the multi selector to adjust volume.
Return to full-frame playback	 / 	Press  or  to exit to full-frame playback.



The **F** (Feature) Menu (📖 9)

The following options can be accessed by pressing **F** when a movie is displayed:

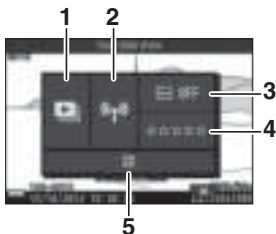



1	Start slide show	93
2	Wi-Fi upload *	82
3	Protect	113
4	Rating	113
5	Edit movie	117

* Displayed when optional WU-1a wireless mobile adapter is connected.



Deleting Movies

To delete the current movie, press . A confirmation dialog will be displayed; press  again to delete the movie and return to playback, or press  to exit without deleting the movie. *Note that once deleted, movies can not be recovered.*

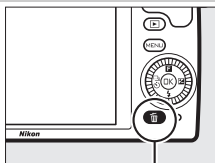

 button

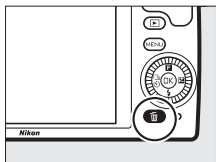

See Also

See page 117 for information on trimming unwanted footage from movies. For information on the frame size and frame rate options available for HD movies, see page 146.

Recording Movies

Flicker, banding, or distortion may be visible in the display and in the final movie under fluorescent, mercury vapor, or sodium lamps or if the camera is panned horizontally or an object moves at high speed through frame (flicker and banding can be reduced by choosing a **Flicker reduction** option that matches the frequency of the local AC power supply as described on page 167, but note that the slowest shutter speed available is $\frac{1}{100}$ s at **50 Hz**, $\frac{1}{60}$ s at **60 Hz**; flicker reduction is not available with slow-motion movies). Bright light sources may leave after-images when the camera is panned. Jagged edges, color fringing, moiré, and bright spots may also appear. When recording movies, avoid pointing the camera at the sun or other strong light sources. Failure to observe this precaution could result in damage to the camera's internal circuitry.

The Movie Crop

The movie crop is shown in the monitor.





Normal crop (16:9)



*Slow-motion movie crop
(8:3)*



Other Shooting Modes

In addition to the modes described above, the camera offers  (best moment capture) mode to help with hard-to-time shots and a  (Motion Snapshot) mode that combines photographs with brief movie vignettes ( 64).

Choosing the Moment (Best Moment Capture)

Choose a shot from 10 frames recorded to temporary storage shortly before or after the shutter is released (Active Selection) or let the camera choose the best shot based on composition and movement (Smart Photo Selector).

Choosing a Shot Manually (Active Selection)

Choose up to 10 shots from 10 frames recorded shortly before or after the shutter-release button is pressed all the way down.

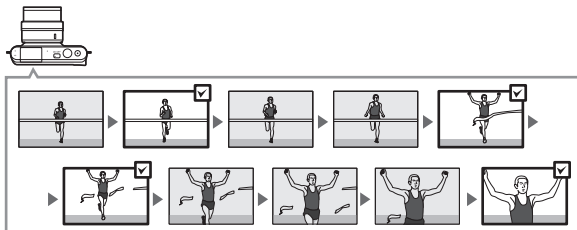

1 Select **☑** mode.

Press the MENU button to display the menus. Highlight **Shooting mode** and press **OK**, then highlight **☑** (best moment capture) and press **OK** (☞ 7).

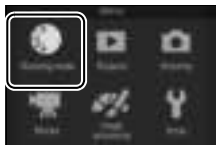

2 Choose **Active Selection**.

Press **F** (feature) to display the **F** menu. Highlight **Best moment capture** and press **OK**, then highlight **Active Selection** and press **OK**.



3 Frame the photograph.

Compose the photograph with your subject in the center of the frame.



4 Begin buffering photographs.

Press the shutter-release button half-way to focus (📖 23). A  icon will be displayed as the camera begins recording images to the memory buffer.









5 Shoot.

Smoothly press the shutter-release button the rest of the way down. The 10 frames recorded to the buffer in the moments before and after the shutter-release button was pressed all the way down will be copied to temporary storage.



6 Select up to 10 frames.

Press  or  to scroll through the frames and press  or  to select or deselect. Selected images are indicated by a  icon, while the remaining images are marked with  icons to show that they will be deleted.



7 Save the selected frames.

Press  to save the selected frames to the memory card. The memory card access lamp will light while recording is in progress; note that some time may be required to save the selected images.

Active Selection

At default settings, the frame recorded at the moment the shutter-release button was pressed all the way down is automatically marked with a  icon in Step 6.

The **F (Feature) Menu 9**

Pressing **F** in best moment capture mode displays the items listed below. The items available vary with the mode selected ( 54, 58).

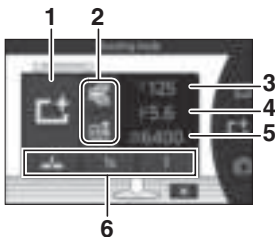

1	Shooting mode.....	7
2	Best moment capture	54
	Exposure mode.....	124
3	Shutter speed.....	36, 38
4	Aperture	37, 38
5	ISO sensitivity.....	154
6	On release, record	127
	Capture 10 frames over	127
	Frames saved (default).....	127
	Number of shots saved.....	127

Available Settings

For information on the options available in best moment capture mode, see page 181.

Best Moment Capture Mode

Movies can not be recorded, and pressing the movie-record button has no effect. The flash can not be used.

See Also

See page 127 for information on adjusting settings for Active Selection.



Letting the Camera Choose the Moment (Smart Photo Selector)

The Smart Photo Selector helps you capture a fleeting expression on the face of a portrait subject or other hard-to-time shots such as group photos in party scenes. Each time the shutter is released, the camera automatically selects the best shot and four best shot candidates based on composition and motion.



1 Select **☐↕** mode.

Press the MENU button to display the menus. Highlight **Shooting mode** and press **OK**, then highlight **☐↕** (best moment capture) and press **OK** (📖 7).



2 Choose Smart Photo Selector.

Press **F** (feature) to display the **F** menu. Highlight **Best moment capture** and press **OK**, then highlight **Smart Photo Selector** and press **OK**.



3 Frame the photograph.

Compose the photograph with your subject in the center of the frame.



4 Begin buffering photographs.

Press the shutter-release button halfway to focus (📖 23). A  icon will be displayed as the camera begins recording images to the memory buffer. The camera continuously adjusts focus to account for changes in the distance to the subject while the shutter-release button is pressed halfway.



5 Shoot.

Smoothly press the shutter-release button the rest of the way down. The camera will compare shots recorded to the buffer both before and after the shutter-release button was pressed all the way down, and select five to copy to the memory card. Note that some time may be required. The best picture is displayed in the monitor when recording is complete.



Smart Photo Selector

The camera automatically chooses a scene mode appropriate to the subject.

Buffering

Buffering begins when the shutter-release button is pressed halfway and ends after about 90 seconds or when the shutter-release button is pressed all the way down.

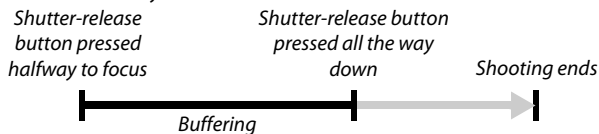

Smart Photo Selector Files



Do not delete the "NCSPSLST.LST" file from the "NCFL" folder on the memory card or change the file names of images taken with the Smart Photo Selector. The camera will no longer recognize the affected files as Smart Photo Selector images and will instead handle them as independent photographs.

See Also

Use the **Number of shots saved** option in the shooting menu to choose the number of shots selected by the Smart Photo Selector (📖 127).





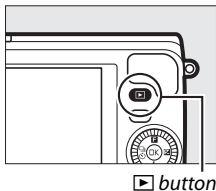

■ Viewing Photos Taken with the Smart Photo Selector

Press  and use the multi selector to display photographs taken with the Smart Photo Selector (book 25; pictures taken with the Smart Photo Selector are indicated by a  icon). Of the photographs recorded by the Smart Photo Selector, only the best shot will be displayed (when you press  to view the next picture, the camera will skip over the best shot candidates, with the result that the next picture displayed will not have a file number that immediately follows that of the current picture). To end playback and return to shooting mode, press the shutter-release button halfway.





Choosing the Best Shot

When a photograph taken with the Smart Photo Selector is displayed, you can choose the best shot by pressing . Press  or  to view the other pictures in the sequence and press  to select the current picture as the best shot. To return to normal playback, press .



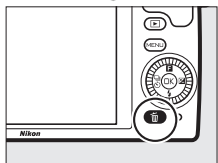
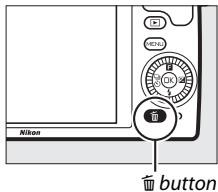

■ Deleting Pictures

Pressing  when a picture taken with the Smart Photo Selector is selected displays a confirmation dialog; press  again to delete the best shot and the best shot candidates, or press  to exit without deleting the pictures. *Note that once deleted, pictures can not be recovered.*



Deleting Individual Photographs

Pressing the  button in the best shot selection dialog displays the following options; highlight an option using the multi selector and press  to select.

- **This image:** Delete the current photo (note that the picture currently selected as the best shot can not be deleted).
- **All except best shot:** Delete the best shot candidates, but not picture currently selected as the best shot.

A confirmation dialog will be displayed; to delete the selected image or images, highlight **Yes** and press .



☑ Combining Photos with Brief Movie Vignettes (Motion Snapshot Mode)

Record brief movie vignettes with your photographs. Each time the shutter is released, the camera records a still image and about 1.6 s of movie footage. When the resulting “Motion Snapshot” is viewed on the camera, the movie will play back in slow motion over approximately 4 s, followed by the still image.

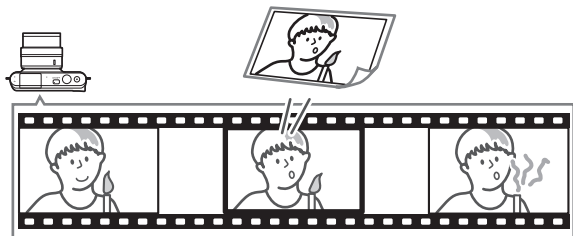

1 Select **☑** mode.

Press the MENU button to display the menus. Highlight **Shooting mode** and press **OK**, then highlight **☑** (Motion Snapshot), and press **OK** (p. 7).

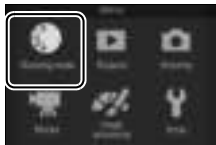

2 Frame the picture.

Compose the photograph with your subject in the center of the frame.



3 Begin buffering.

Press the shutter-release button halfway to focus (📖 23). A  icon will be displayed as the camera begins recording footage to the memory buffer.



4 Shoot.

Smoothly press the shutter-release button the rest of the way down. The camera will record a photograph, together with about 1.6 s of movie footage beginning before and ending after the time the shutter-release button was pressed all the way down. Note that some time may be required. When recording is complete, the photograph will be displayed for a few seconds.



Buffering

Buffering begins when the shutter-release button is pressed halfway and ends after about 90 seconds or when the shutter-release button is pressed all the way down.

*Shutter-release
button pressed
halfway to focus*

*Shutter-release button
pressed all the way
down*

Shooting ends



The **F** (Feature) Menu (📖 9)

Pressing **F** in Motion Snapshot mode displays the following items:

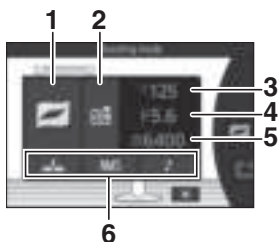



1	Shooting mode.....	7
2	Exposure mode.....	124
3	Shutter speed.....	36, 38
4	Aperture	37, 38
5	ISO sensitivity.....	154
6	Movie before/after.....	128
	File format.....	129
	Audio.....	67

Available Settings

For information on the options available in Motion Snapshot mode, see page 181.

■ Audio

To record about four seconds of sound with Motion Snapshots beginning at the start of movie recording, use the multi selector and  button to select **Ambient** for **Audio** in the **F** (feature) menu ( 66). Motion Snapshots can also be recorded with background music (**Background music**) or no sound (**None**).





Motion Snapshot Mode

Movies can not be recorded using the movie-record button and the flash can not be used.

See Also

See page 128 for information on choosing what portions of the buffer are included in the movie footage. For information on saving Motion Snapshots in a format that can be viewed in most movie playback software, see page 129. See page 120 for information on combining the movie portions of multiple Motion Snapshots into a single movie.

Viewing Motion Snapshots

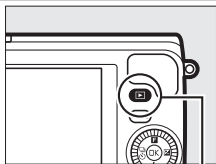

Press  and use the multi selector to display a Motion Snapshot (📖 25; Motion Snapshots are indicated by a  icon). Pressing  when a Motion Snapshot is displayed plays back the movie portion in slow motion over a period of about 4 s, followed by the photo; playback is accompanied by the audio track selected using the **Audio** option (📖 67). To end playback and return to shooting mode, press the shutter-release button halfway.



 button



Deleting Motion Snapshots

To delete the current Motion Snapshot, press . A confirmation dialog will be displayed; press  again to delete the photo and movie and return to playback, or press  to exit without deleting the file. *Note that once deleted, Motion Snapshots can not be recovered.*

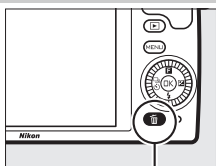

 button

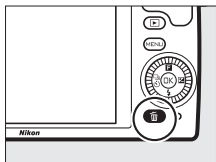



More on Photography

This section describes other features you can use when taking pictures.

Continuous Mode

Shoot a continuous series (burst) of photographs.

1 Display release mode options.

Press ◀ (S) to display release mode options.









2 Select .

Highlight  (continuous) and press ▶ to display frame rate options.



3 Select a frame rate.

Highlight the desired frame rate and press . Frame rate is expressed in terms of the number of frames recorded per second (fps); choose from frame rates of approximately 5, 10, 20, 30, and 60 fps (, , , , and , respectively). Except when  is selected, the maximum number of shots that can be recorded in a single burst is 10.



4 Frame your subject and shoot.

Press the shutter-release button all the way down to shoot the burst.



Continuous Mode

Only one picture will be taken if the flash fires when  is selected; at settings of 10, 20, 30, and 60 fps, the built-in flash will not fire.

While photographs are being recorded to the memory card, the memory card access lamp will light. Depending on shooting conditions and memory card write speed, recording may take some time. If the battery is exhausted before all photographs are recorded, the shutter release will be disabled and the remaining images transferred to the memory card.

Continuous shooting is not available in creative modes other than **P**, **S**, **A**, or **M**, in best moment capture, advanced movie, or Motion Snapshot mode, or when live image control is used in auto mode ( 30).

Buffer Size

The camera is equipped with a memory buffer for temporary storage, allowing shooting to continue while photographs are being saved to the memory card. The approximate number of images that can be stored in the memory buffer at current settings is displayed while the shutter-release button is pressed halfway (this number is an approximation only and varies with shooting conditions). The illustration shows the display when space remains in the buffer for about 20 pictures.

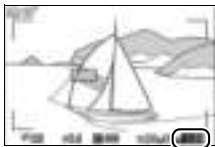

Single Frame

To take only one picture each time the shutter-release button is pressed all the way down, select  (single frame) for release mode.

Self-Timer Modes

The self-timer is used to delay shutter release until 10 or 2 seconds after the shutter-release button is pressed all the way down.

1 Display release mode options.

Press ◀ (📷) to display release mode options.



2 Select 10s.

Highlight 10s (self-timer) and press ▶ to display self-timer options.



3 Select the desired self-timer option.

Use the multi selector to highlight 10s or 2s and press (OK).



4 Mount the camera on a tripod.

Mount the camera on a tripod or place the camera on a stable, level surface.



5 Frame the photograph and shoot.

Press the shutter-release button half-way to focus, and then press the button the rest of the way down. The self-timer lamp will start to flash and a beep will begin to sound. Two seconds before the photo is taken, the lamp will stop flashing and the beeping will become more rapid.

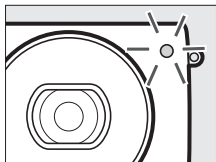

Note that the timer may not start or a photograph may not be taken if the camera is unable to focus or in other situations in which the shutter can not be released. Turning the camera off cancels the self-timer.



Movie Mode

To record movies using the self-timer, select advanced movie mode and use the movie-record button to start the timer. Movie recording ends when the movie-record button is pressed a second time.

Raising the Flash

In **P**, **S**, **A**, or **M** mode, press the flash pop-up button to raise the flash before shooting. Shooting will be interrupted if the flash is raised while the timer is counting down.

See Also

For information on controlling the beeps that sound when the self-timer is used, see page 166.

Exposure Compensation

Exposure compensation is used to alter exposure from the value suggested by the camera, making pictures brighter or darker.



-1 EV



No compensation



+1 EV

1 Display exposure compensation options.

Press **▶** (**☒**) to display exposure compensation options.



2 Choose a value.

Use the multi selector to choose from values between -3 EV (underexposure) and +3 EV (overexposure) in increments of $\frac{1}{3}$ EV. In general, positive values make the image brighter while negative values make it darker.



Normal exposure can be restored by setting exposure compensation to ± 0 . In modes **P**, **S**, and **A**, exposure compensation is not reset when the camera is turned off.

Exposure Compensation

Exposure compensation is most effective when used with center-weighted or spot metering ( 130).

The Built-in Flash



When used with the built-in flash, exposure compensation affects both background exposure and flash level.





The Built-in Flash

Use the built-in flash for additional lighting when the subject is poorly lit or to “fill-in” (illuminate) back-lit subjects. The built-in flash is available in the following shooting modes, but note that some camera settings automatically disable the built-in flash:

Auto Pop-up Modes

In  (auto) mode and when soft, miniature effect, selective color, cross process, or toy camera effect is selected in  (creative) mode, the flash will pop-up automatically and fire when required.

1 Choose a flash mode.

Press  () on the multi selector to display a list of flash modes, then use the multi selector to highlight the desired mode and press  to select.

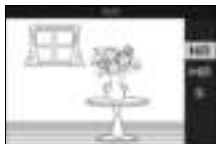





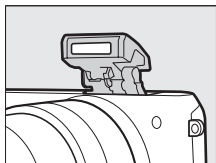



2 Take pictures.

Press the shutter-release button half-way to focus and the rest of the way down to shoot. The flash will pop up and fire when required.



Flash Modes

The following flash modes are available in  (auto),  (soft),  (miniature effect),  (selective color),  (cross process), and  (toy camera effect) modes:

-  AUTO (auto flash): When lighting is poor or the subject is backlit, the flash pops up automatically when the shutter-release button is pressed halfway and fires as required.
-  AUTO (auto with red-eye reduction): Use for portraits. The flash pops up and fires as required, but before it fires, the red-eye reduction lamp lights to help reduce “red-eye.”
-  (off): The flash does not fire.



Manual Pop-up Modes

When **P**, **S**, **A**, or **M** is selected in **CC** (creative) mode, the flash must be raised manually. The flash will not fire if it is not raised.

1 Raise the flash.

Press the flash pop-up button to raise the flash.

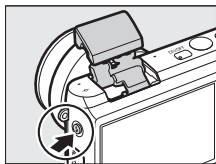

Flash pop-up button

2 Choose a flash mode.

Press **▼** (⚡) on the multi selector to display a list of flash modes, then use the multi selector to highlight the desired mode and press **OK** to select.







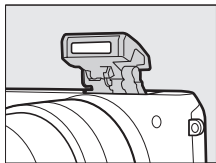

3 Take pictures.

The flash will fire with every shot. To disable the flash, press it gently downward until it latches.



Flash Modes

The following flash modes are available when **P**, **S**, **A**, or **M** is selected in **CC** (creative) mode:

-  (fill flash): The flash fires with every shot.
-  (red-eye reduction): Use for portraits. The flash fires with every shot, but before it fires, the red-eye reduction lamp lights to help reduce “red-eye.”
-  **SLOW** (red-eye reduction with slow sync): As for “red-eye reduction”, above, except that shutter speed slows automatically to capture background lighting at night or under low light. Use when you want to include background lighting in portraits. Available only in modes **P** and **A**.
-  **SLOW** (fill flash + slow sync): As for “fill flash”, above, except that shutter speed slows automatically to capture background lighting at night or under low light. Use when you want to capture both subject and background. Available only in modes **P** and **A**.
-  **SLOW REAR** (rear curtain + slow sync): As for “rear-curtain sync”, below, except that shutter speed slows automatically to capture background lighting at night or under low light. Use when you want to capture both subject and background. Available only in modes **P** and **A**.
-  **REAR** (rear-curtain sync): The flash fires just before the shutter closes, creating a stream of light behind moving light sources as shown below at right. Available only in modes **S** and **M**.



Front-curtain sync



Rear-curtain sync

-  (off): The flash does not fire. Available only when built-in flash is raised.



✓ Raising the Flash

When using the flash, be sure it is fully raised as shown at right. Do not touch the flash during shooting.

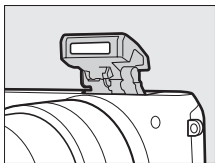

✎ Lowering the Built-in Flash

To save power when the flash is not in use, press it gently downward until the latch clicks into place. *Do not use force.* Failure to observe this precaution could result in product malfunction.

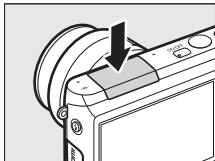

✎ The Flash-Ready Indicator

The flash-ready indicator (⚡) lights to show that the flash is fully charged when the shutter-release button is pressed halfway.

✎ Preventing the Built-in Flash from Firing

Lowering the flash prevents it firing in modes **P**, **S**, **A**, and **M**. The flash can also be turned off by selecting a flash mode of (☹) (off).



Using the Built-in Flash

If the flash is fired multiple times in quick succession, the flash and shutter may be temporarily disabled to protect the flash. Shooting can be resumed after a brief pause.

Objects close to the camera may be overexposed in photographs taken with the flash at high ISO sensitivities.

To avoid vignetting, remove lens hoods and shoot at ranges of at least 0.6 m (2 ft). Some lenses may cause vignetting at greater distances or obstruct the red-eye reduction lamp, interfering with red-eye reduction. The following illustrations show the effect of vignetting caused by shadows cast by the lens when the built-in flash is used.

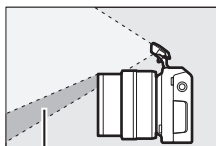

Shadow



Shadow

See Also

See page 142 for information on adjusting flash level.

Aperture, Sensitivity, and Flash Range

Flash range varies with sensitivity (ISO equivalency) and aperture.



The WU-1a Wireless Mobile Adapter

Attach an optional WU-1a wireless mobile adapter to the camera USB connector to copy images to, or control the camera from, smartphone or tablet devices running the Wireless Mobile Utility app. For information on using the camera to upload selected pictures to the smart device, see page 82.

1 Connect the WU-1a.

Turn the camera off and connect the WU-1a to the camera USB connector.

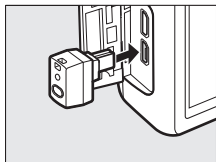

2 Activate the adapter.

Select **Wireless mobile adapter** in the setup menu. A confirmation dialog will be displayed; select **Yes** to activate the WU-1a, allowing wireless connection to smart devices, or **No** to deactivate the WU-1a and prevent wireless connection.

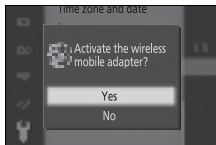

Using the WU-1a

See the WU-1a manual for more information. Note that you may need to adjust smart device wireless settings before proceeding.

3 Launch the Wireless Mobile Utility.

Launch the Wireless Mobile Utility on the smart device.

4 Take pictures remotely.

Once a wireless connection is established, the smart device will display the view through the camera lens; the camera will display a message stating that a wireless connection is active.



Wireless Networks

Camera settings can not be adjusted while the camera is connected to a wireless network. To end the connection, press the MENU button.

The Wireless Mobile Utility

The Wireless Mobile Utility is available from Google Play and the App Store. System requirements and Information on installation, wireless connections and use may be found in the Wireless Mobile Utility manual available in pdf format from the following URL:

<http://nikonimglib.com/ManDL/WMAU/>



Uploading Pictures to a Smart Device

Follow the steps below to upload photos from the camera to a smart device. Movies can not be selected for upload.

■ Uploading Photos One at a Time

Use the **Wi-Fi upload** option in the playback **F** (feature) menu (📖 9) to upload the photo currently displayed in full-frame playback.

1 Display the photo on the camera.

Display the desired photo in full-frame playback.

2 Select Wi-Fi upload.

Press **F** (feature) to display the **F** menu, then highlight **Wi-Fi upload** and press **OK**. A confirmation dialog will be displayed.



3 Select Yes.

Highlight **Yes** and press **OK**. To upload multiple selected photos, choose **Select images from list** and proceed to Step 2 on page 83.

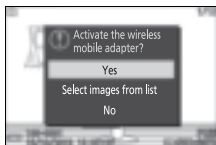

4 Select the camera SSID on the smart device.

Select the camera SSID in the list of networks displayed by the smart device.

5 Download the photo to the smart device.

Launch the Wireless Mobile Utility on the smart device and follow the on-screen instructions to download the photo. When download is complete, press the MENU button on the camera to terminate the Wi-Fi connection.

■ ■ Uploading Multiple Selected Photos

To upload multiple selected photos, use the **Wi-Fi upload** option in the playback menu.

1 Choose Wi-Fi upload.

Press the MENU button to display the menus. Highlight **Wi-Fi upload** in the playback menu and press ►.

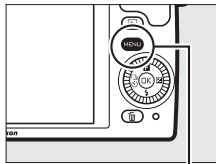

MENU button

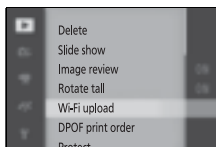

2 Select photos.

Press ◀ or ▶ to scroll through pictures and press ▼ to select or deselect, or press and hold ▲ to view the highlighted picture full frame. Selected images are indicated by a  icon.



3 Press **OK**.

Press **OK** to complete the operation. A confirmation dialog will be displayed.

4 Select **Yes**.

Highlight **Yes** and press **OK**.

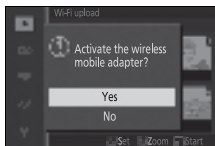

5 Select the camera SSID on the smart device.

Select the camera SSID in the list of networks displayed by the smart device.

6 Download the photos to the smart device.

Launch the Wireless Mobile Utility on the smart device and follow the on-screen instructions to download the selected photos. When download is complete, press the MENU button on the camera to terminate the Wi-Fi connection.



More on Playback

Photo Information

Photo information is superimposed on images displayed in full-frame playback (☞ 25). The information displayed can be selected using the **Display > Playback** option in the setup menu (☞ 165).

■ Basic Info

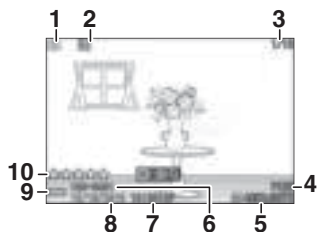

Still images

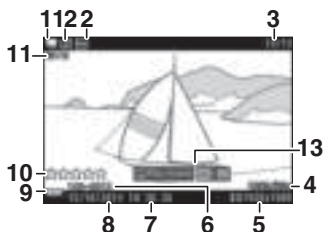

Movies

1 Shooting mode	6 Folder number-file number 87
2 Protect status 113	7 Time of recording 19, 168
3 Frame number/total number of images	8 Date of recording 19, 168
4 Image quality 125	9 Battery indicator 21
Frame rate 145, 146	10 Rating 92
5 Image size 125	11 Movie length 51
Frame size 145, 146	12 Audio recording indicator 147
	13 On-screen guide (for movies) 51



■ Detailed info

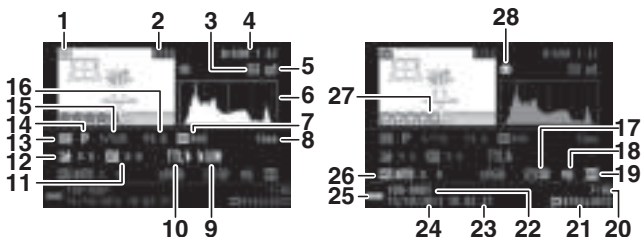

Still images

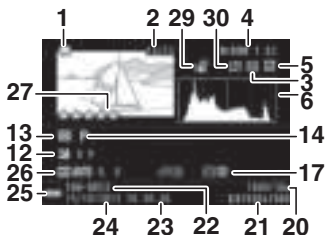

Movies

1 Shooting mode	16 Aperture..... 37, 38
2 Frame number/total number of images	17 Picture Control 155
3 Protect status..... 113	18 Active D-Lighting indicator..... 132
4 Camera name	19 HDR indicator 42
5 Retouch indicator 114, 115, 116	20 Image quality 125
Movie edit indicator..... 117	Frame rate 145, 146
6 Histogram showing distribution of tones in image 87	21 Image size..... 125
7 ISO sensitivity 154	Frame size..... 145, 146
8 Focal length 198, 199	22 Folder number-file number 87
9 Flash mode 75, 77	23 Time of recording 19, 168
10 Flash control..... 141	24 Date of recording..... 19, 168
11 Flash compensation..... 142	25 Battery indicator..... 21
12 Exposure compensation 73	26 White balance..... 149
13 Metering 130	White balance fine-tuning 150
14 Creative mode 32	27 Rating 92
Exposure mode 124	28 Auto distortion control 131
15 Shutter speed 36, 38	29 Electronic VR..... 134
	30 Audio recording indicator 147

Folder and File Numbers

Photographs are stored as files with names containing a four-digit number between 0001 and 9999 assigned automatically in ascending order by the camera. These in turn are stored in folders containing up to 999 images. A new folder is created automatically when file numbering reaches 9999 or the number of images in the current folder reaches 999.

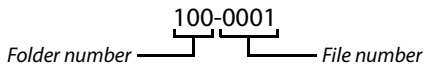

Histograms 86

Camera histograms are intended only as a guide and may differ from those in imaging applications. Sample histograms are shown below:

- **If brightness varies evenly across the image**, the distribution of tones will be relatively even.
- **If the image is dark**, tone distribution will be shifted to the left.
- **If the image is bright**, tone distribution will be shifted to the right.

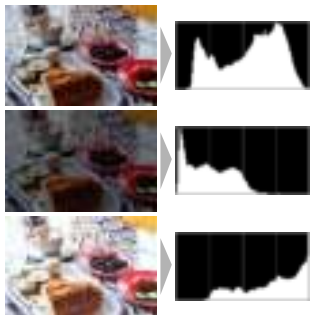











Exposure compensation shifts the distribution of tones to the right when raised, to the left when lowered. Histograms can give you a rough idea of overall exposure when bright ambient lighting makes it difficult to see the display in the monitor.



Thumbnail Playback

To view pictures in “contact sheets” of 4, 9, or 16 images, press  when a picture is displayed full frame and rotate the multi selector counterclockwise.







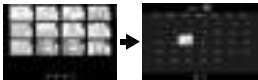

The following operations can be performed:

To	Use	Description
Display more images		Rotate the multi selector counterclockwise to increase the number of images displayed from 1 to 4, from 4 to 9, or from 9 to 16. To view images taken on selected dates ( 89), rotate the selector counterclockwise when 16 images are displayed. 
Display fewer images		Rotate the multi selector clockwise to reduce the number of images displayed from 16 to 9 or 9 to 4. To view the highlighted image full frame, rotate the selector clockwise when 4 images are displayed. 
Highlight images		Use the multi selector to highlight images. You can delete ( 91) the highlighted image or zoom in for a closer look ( 90).
View highlighted image		Press  to view the highlighted image full frame.
Delete highlighted image		See page 91.

Calendar Playback

To view pictures taken on a selected date, rotate the multi selector counterclockwise when 16 pictures are displayed (☐ 88).

The following operations can be performed:













To	Use	Description
Display calendar		To view the calendar, rotate the multi selector counterclockwise when 16 images are displayed (☐ 88). 
Exit to thumbnail playback		To return to the 16-image display, rotate the multi selector clockwise when the calendar is displayed. 
Highlight date		Use multi selector to highlight date in calendar display.
View pictures taken on highlighted date		Press  to view the first picture taken on the highlighted date.
Delete pictures taken on highlighted date		Press  to delete all pictures taken on the highlighted date.



Playback Zoom

To zoom in on a photograph, display it full frame and press  and rotate the multi selector clockwise. Playback zoom is not available with movies or Motion Snapshots.

The following operations can be performed:

To	Use	Description	
Zoom in		Rotate the multi selector clockwise to zoom in, counterclockwise to zoom out. Whenever you zoom in or out, a navigation window will appear with the area currently visible in the display indicated by a yellow border.	
Zoom out			
View other areas of image		Press  ,  ,  , or  to scroll the image.	
View faces		Faces (up to five) detected during face priority are indicated by white borders in the navigation window. Press  or  to view other faces.	
Exit zoom		Return to full-frame playback.	



See Also

The **Face-priority zoom** option in the playback menu ( 117) is used to choose whether the multi selector to be used to scroll from face to face during face-priority zoom.

Deleting Pictures

Pictures can be deleted from the memory card as described below. *Note that once deleted, pictures can not be recovered; protected images, however, will not be deleted.*

Deleting the Current Picture

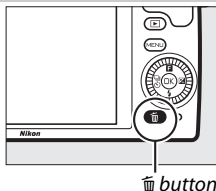

To delete the picture currently displayed in full-frame playback or selected in the thumbnail list, press . A confirmation dialog will be displayed; press  again to delete the picture and return to playback, or press  to exit without deleting the picture.



The Playback Menu

To delete multiple images, press the MENU button, select **Delete** in the playback menu, and choose from the options below. A confirmation dialog will be displayed; select **Yes** to delete the images (note that some time may be required if a large number of images is selected).



Delete selected images	Highlight images and press  to select or deselect ( 112). Press  to exit when the selection is complete.
Delete all images	Delete all pictures on the memory card.

Rating Pictures

Rate pictures or mark them as candidates for later deletion. Rating is not available with protected images.

1 Select a picture.

Display a picture in full-frame playback.

2 Select Rating.

Press **F** (feature) to display the **F** menu. Highlight **Rating** and press **OK**.



3 Choose a rating.

Highlight a rating of from zero to five stars, or select **F** to mark the picture as a candidate for later deletion. Press **OK** to select the highlighted rating.



Slide Shows

To view a slide show of the pictures on the memory card, press the **MENU** button, select **Slide show** in the playback menu, and follow the steps below.

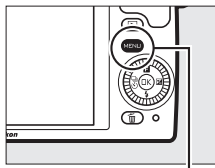

MENU button

1 Select the type of image used in the show.

Highlight the desired option and press **OK**.

All images	Display all the images on the memory card.
Still images	Display still images only.
Movies	Display movies and Motion Snapshots recorded with MOV file selected for File format (📖 129).
Motion Snapshot	Display Motion Snapshots recorded with NMS files selected for File format (📖 129). Only the movie portion will be played; the associated photographs are not displayed.
Select images by date	Display only images recorded on a selected date. A calendar will be displayed; use the multi-selector to highlight a date.



2 Adjust display times and audio settings.

Adjust the following options:





Frame interval	Choose how long each still image is displayed.
Movie playback time	Choose how much of each movie is played back before the next slide is displayed. Choose Same as frame interval to display the next slide after the time selected for Frame interval , No limit to play back the entire movie before displaying the next slide.
Audio	Mute audio playback, or select Movie sound tracks to play audio recorded with movies and with Motion Snapshots recorded with Ambient selected for Audio (□ 67). No sound is played for still images.

3 Select Start.

Highlight **Start** and press  to start the slide show.



The following operations can be performed while a slide show is in progress:

To	Use	Description
Skip back/skip ahead		Press ◀ to return to the previous frame, ▶ to skip to the next frame.
Pause/resume		Pause the show. Press again to resume.
Adjust volume		Rotate the multi selector to adjust volume.
Exit to playback mode		End the show and return to playback mode.

The options shown at right are displayed when the show ends. Select **Resume** to restart or **Exit** to exit to the playback menu.



Installing the Supplied Software

Install the supplied software to copy pictures to your computer for viewing and editing. Before installing the software, confirm that your system meets the requirements on page 98.

1 Launch the installer.

Start the computer, insert the ViewNX 2 installer CD, and launch the installer. A language-selection dialog will be displayed; if the desired language is not available, click **Region Selection** to choose a different region and then choose the desired language (region selection is not available in the European release).

① *Select region (if required)*

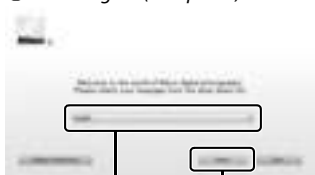

② *Select language*

③ *Click Next*

2 Start the installer.

Click **Install** and follow the on-screen instructions.



3 Exit the installer.

Click **Yes** (Windows) or **OK** (Mac) when installation is complete.



4 Remove the installer CD from the CD-ROM drive.

Supplied Software

Be sure to update to the latest versions of the supplied software. Nikon Message Center 2 will periodically check for updates while the computer is connected to the Internet.

Motion Snapshots

ViewNX 2 is required to view Motion Snapshots saved using the **File format > NMS files** option in the shooting menu (p 129).

Supported Operating Systems

See the websites listed on page xvii for the latest information on supported operating systems.



System Requirements

The system requirements for ViewNX 2 are:

Windows	
CPU	<ul style="list-style-type: none">• Photos: Intel Celeron, Pentium 4, Core Series; 1.6 GHz or better• Movies (playback): Pentium D 3.0 GHz or better; Intel Core i5 or better recommended when viewing movies with a frame size of 1280 × 720 or more at a frame rate of 30 fps or above or movies with a frame size of 1920 × 1080 or more• Movies (editing): Intel Core i5 or better
OS	Pre-installed versions of Windows 8.1, Windows 7, or Windows Vista
Memory (RAM)	<ul style="list-style-type: none">• 32-bit Windows 8.1, Windows 7, or Windows Vista: 1 GB or more (2 GB or more recommended)• 64-bit Windows 8.1, Windows 7, or Windows Vista: 2 GB or more (4 GB or more recommended)
Hard disk space	A minimum of 1 GB available on the startup disk (3 GB or more recommended)
Graphics	<ul style="list-style-type: none">• Resolution: 1024 × 768 pixels (XGA) or more (1280 × 1024 pixels or more recommended)• Color: 24-bit color (True Color) or more



Mac	
CPU	<ul style="list-style-type: none"> • Photos: Intel Core or Xeon series • Movies (playback): Core Duo 2 GHz or better; Intel Core i5 or better recommended when viewing movies with a frame size of 1280 × 720 or more at a frame rate of 30 fps or above or movies with a frame size of 1920 × 1080 or more • Movies (editing): Intel Core i5 or better
OS	OS X 10.9, 10.8, or 10.7
Memory (RAM)	2 GB or more (4 GB or more recommended)
Hard disk space	A minimum of 1 GB available on the startup disk (3 GB or more recommended)
Graphics	<ul style="list-style-type: none"> • Resolution: 1024 × 768 pixels (XGA) or more (1280 × 1024 pixels or more recommended) • Color: 24-bit color (millions of colors) or more



Viewing and Editing Pictures on a Computer

Transferring Pictures

1 Choose how pictures will be copied to the computer.

Choose one of the following methods:

- **Direct USB connection:** Turn the camera off and ensure that the memory card is inserted in the camera. Connect the camera to the computer using the supplied USB cable (do not use force or insert the connectors at an angle) and then turn the camera on.

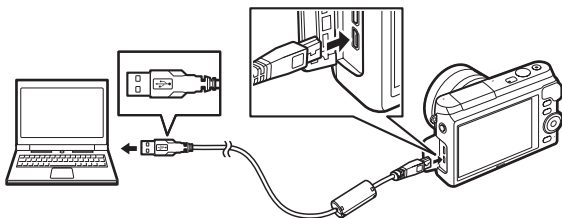

- **Card slot:** If your computer is equipped with a slot for microSD memory cards, the card can be inserted directly in the slot.
- **Card reader:** Connect a card reader (available separately from third-party suppliers) to the computer and insert the memory card.

2 Start the Nikon Transfer 2 component of ViewNX 2.

If a message is displayed prompting you to choose a program, select Nikon Transfer 2.

Windows 7

If the following dialog is displayed, select Nikon Transfer 2 as described below.

- 1 Under **Import pictures and videos**, click **Change program**. A program selection dialog will be displayed; select **Import File using Nikon Transfer 2** and click **OK**.



- 2 Double-click **Import file**.

3 Click Start Transfer.

At default settings, all the pictures on the memory card will be copied to the computer.



Click **Start Transfer**

4 Terminate the connection.

If the camera is connected to the computer, turn the camera off and disconnect the USB cable. If you are using a card reader or card slot, choose the appropriate option in the computer operating system to eject the removable disk corresponding to the memory card and then remove the card from the card reader or card slot.



Viewing Pictures

Pictures are displayed in ViewNX 2 when transfer is complete.

Starting ViewNX 2 Manually

- **Windows:** Double-click the ViewNX 2 shortcut on the desktop.
- **Mac:** Click the ViewNX 2 icon in the Dock.



Retouching Photographs

To crop pictures and perform such tasks as adjusting sharpness and tone levels, click the **Edit** button in the toolbar.



Printing Pictures

Click the **Print** button in the toolbar. A dialog will be displayed, allowing you to print pictures on a printer connected to the computer.



For More Information

Consult online help for more information on using ViewNX 2.



Viewing Pictures on TV

Connect the camera to a television for playback.

Connecting an HDMI Cable

Always turn the camera off before connecting or disconnecting HDMI cables. When connecting cables, do not use force or attempt to insert the connectors at an angle.

High-Definition Devices

A type D High-Definition Multimedia Interface (HDMI) cable (available separately from third-party suppliers) can be used to connect the camera to high-definition video devices.

1 Connect the HDMI cable.

Turn the camera off and connect the HDMI cable.

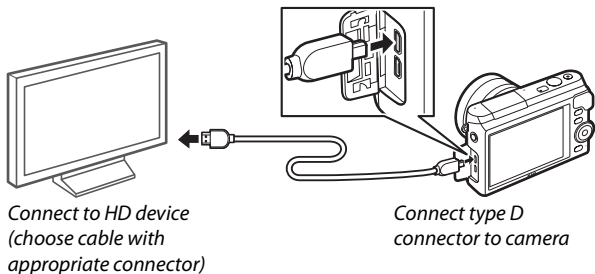

2 Tune the device to the HDMI channel.

3 Turn the camera on.

Turn the camera on; the camera monitor will remain off and the camera shooting mode display will appear on the HD device. Pictures can be played back using camera controls as described elsewhere in this manual; note that the edges of images may not be visible in the display.

Close the Connector Cover

Close the connector cover when the connectors are not in use. Foreign matter in the connectors can interfere with data transfer.

Television Playback

Volume can be adjusted using the controls on the television; adjusting volume on the camera has no effect. Use of an EH-5b AC adapter and EP-5E power connector (available separately) is recommended for extended playback.

Electronic VR

Electronic vibration reduction ( 134) can not be used while an HDMI cable is connected.

■■ HDMI Device Control

To control the camera remotely from a device that supports HDMI-CEC (**H**igh-**D**efinition **M**ultimedia **I**nterface-**C**onsumer **E**lectronics **C**ontrol), select **On** for **HDMI device control** in the camera setup menu. For information on using a remote control, see the television manual.



Printing Photographs

Selected JPEG images can be printed on a PictBridge printer connected directly to the camera.

Connecting the Printer

Connect the camera using the supplied USB cable.

1 Turn the camera off.

2 Connect the USB cable.

Turn the printer on and connect the USB cable as shown. Do not use force or attempt to insert the connectors at an angle.

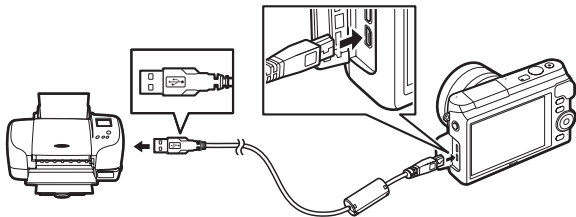

3 Turn the camera on.

A welcome screen will be displayed in the monitor, followed by a PictBridge playback display. To print pictures one at a time, proceed to page 106. To print multiple selected pictures or all pictures, proceed to page 108.

Selecting Photographs for Printing

Movies and NEF (RAW) photographs (☐ 125) can not be selected for printing. If Motion Snapshots are selected, only the photographs will be printed; the movie portion will not be printed. If photographs taken with the Smart Photo Selector are selected, only the best shot will be printed.

Printing Pictures One at a Time

1 Display the desired picture.

Press ◀ or ▶ to view additional pictures. Rotate the multi selector clockwise to zoom in on the current frame (□ 90; rotate the multi selector counterclockwise to exit zoom). To view nine pictures at a time, rotate the selector counterclockwise when a picture is displayed full frame. Press ▲, ▼, ◀, or ▶ to highlight pictures, or rotate the multi selector clockwise to display the highlighted picture full frame.



2 Adjust printer settings.

Press Ⓞ to display the following items, then press ▲ or ▼ to highlight an item and press ▶ to view options (only options supported by the current printer are listed; to use the default option, select **Use printer settings**). After selecting an option, press Ⓞ to return to the printer settings menu.

Option	Description
Page size	Choose a page size.
Number of copies	This option is listed only when pictures are printed one at a time. Press ▲ or ▼ to choose number of copies (maximum 99).
Print border	Choose whether to frame photos in white borders.
Print time stamp	Choose whether to print the times and dates of recordings on photos.
Crop	This option is listed only when pictures are printed one at a time. To exit without cropping, highlight No and press Ⓞ. To crop the current picture, highlight Yes and press ▶. A crop selection dialog will be displayed; rotate the multi selector clockwise to increase the size of the crop, counterclockwise to decrease. Press ▲, ▼, ◀, or ▶ to position the crop. Note that print quality may drop if small crops are printed at large sizes.



3 Start printing.

Highlight **Start printing** and press  to start printing. To cancel before all copies have been printed, press  again.



Printing Multiple Pictures

1 Display the PictBridge menu.

Press the MENU button in the PictBridge playback display (□ 105).

2 Choose an option.



Highlight one of the following options and press ►.

- **Select images for printing:** Select pictures for printing. Press ◀ or ► to highlight pictures and press ▲ or ▼ to choose the number of prints (up to 99).
- **Print DPOF print order:** Print the current DPOF print order (□ 109). The order can be viewed and modified before printing as described above under “Select images for printing”.
- **Index print:** To create an index print of all JPEG pictures on the memory card, proceed to Step 3. Note that if the memory card contains more than 256 pictures, a confirmation dialog will be displayed and only the first 256 images will be printed. A warning will be displayed if the page size selected in Step 3 is too small.

3 Adjust printer settings.

Adjust printer settings as described in Step 2 on page 106.

4 Start printing.

Highlight **Start printing** and press  to start printing. To cancel before all copies have been printed, press  again.

Errors

See page 190 for information on what to do if an error occurs during printing.

Creating a DPOF Print Order: Print Set

The **DPOF print order** option is used to create digital “print orders” for PictBridge-compatible printers and devices that support DPOF. Press the MENU button, select **DPOF print order** in the playback menu, and choose from the following options:

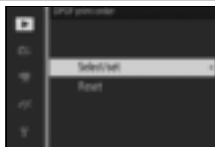

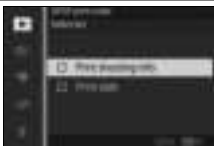
Select/set	Press ◀ or ▶ to highlight pictures (□ 112). To select the current picture for printing, press ▲. The picture will be marked with a ☐ icon and the number of prints will be set to 1; press ▲ or ▼ to specify the number of prints (up to 99; to deselect the picture, press ▼ when the number of prints is 1). When the selection is complete, press Ⓚ to display printing options. Highlight Print shooting info (print the shutter speed and aperture on all pictures in the print order) or Print date (print the date of recording on all pictures in the print order) and press ▶ to select or deselect, and then press Ⓚ to complete the print order.	 A screenshot of a camera's print order menu. The menu is dark with white text. At the top, it says 'Print order'. Below that, there are two options: 'Print shooting info' and 'Print date'. The 'Print shooting info' option is currently highlighted with a white bar.
Reset	Remove all pictures from the print order.	

DPOF Print Order

DPOF date and shooting info options are not supported when printing via direct USB connection; to print the date of recording on photographs in the current print order, use the PictBridge **Print time stamp** option (□ 106).

The **DPOF print order** option can not be used if there is not enough space on the memory card to store the print order. For restrictions on the types of images that can be selected for printing, see page 105.

Print orders may not print correctly if images are deleted using a computer or other device after the print order is created.





The Playback Menu

To display the playback menu, press **MENU** and select **Playback**.



The playback menu contains the following options:

Option	Description	Default	
Delete	Delete multiple images.	—	91
Slide show	View movies and photos in a slide show.	Image type: All images Frame interval: 4 s Movie playback time: Same as frame interval Audio: Movie sound tracks	93
Image review	Choose whether pictures are displayed after shooting.	On	113
Rotate tall	Rotate "tall" (portrait-orientation) pictures for display during playback.	On	113
Wi-Fi upload	Upload selected photos to smart devices via wireless networks when a WU-1a wireless mobile adapter is connected.	—	82
DPOF print order	Create digital "print orders".	—	109
Protect	Protect pictures from accidental deletion.	—	113
Rating	Rate pictures.	—	113

Option	Description	Default	
D-Lighting	Brighten shadows in dark or backlit photos, creating a retouched copy that is saved separately from the unmodified original.	—	114
Resize	Create small copies of selected pictures.	Choose size: 1280×856; 1.1 M	115
Crop	Create cropped copies of selected pictures.	Aspect ratio: 3 : 2	116
Face-priority zoom	Choose whether ◀ and ▶ can be used during playback zoom ( 90) to select faces detected with face priority.	On	117
Edit movie	Create copies of movies from which unwanted footage has been trimmed.	—	117
Combine 4-second movies	Combine multiple 4-second movies into a single movie.	—	119
Combine NMS movies	Make a movie from the movie portions of multiple Motion Snapshots.	—	120

Playback

The camera may be unable to display or retouch images that were created or have been edited with other devices.

Image Quality

Copies created from JPEG photos are the same quality as the original. NEF (RAW) images can not be retouched ( 125).



Selecting Multiple Images

Choosing the options listed below displays an image selection dialog. Press ◀ or ▶ to highlight pictures (only pictures to which the operation applies are available for selection).

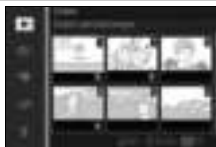

- **Delete > Delete selected images** (📖 91)
- **Wi-Fi upload** (📖 82)
- **DPOF print order > Select/set** (📖 109)
- **Protect > Select/set** (📖 113)
- **Rating** (📖 113)
- **D-Lighting** (📖 114)
- **Resize > Select images** (📖 115)
- **Crop > Select images** (📖 116)
- **Edit movie** (📖 117)
- **Combine 4-second movies** (📖 119)
- **Combine NMS movies** (📖 120)



Image Review

If **On** is selected, pictures will be displayed immediately after shooting. To view pictures when **Off** is selected, press the  button.





Rotate Tall

Choose whether to rotate “tall” (portrait-orientation) pictures for display during playback. Note that because the camera itself is already in the appropriate orientation during shooting, images are not rotated automatically during image review.







On	“Tall” (portrait-orientation) pictures are automatically rotated for display in the camera monitor. Pictures taken with Off selected for Auto image rotation ( 169) will be displayed in “wide” (landscape) orientation.
Off	“Tall” (portrait-orientation) pictures are displayed in “wide” (landscape) orientation.

Protect

Protect selected images from accidental deletion. Note that this option does NOT protect files from deletion when the memory card is formatted ( 164).

Select/set	Press  or  to highlight pictures ( 112) and press  to select or deselect. Press  to exit when the operation is complete.
Reset	Remove protection from all pictures.

Rating

Press  or  to highlight pictures ( 112) and press  or  to choose a rating ( 92). Press  to exit when the operation is complete.



D-Lighting



Applied to selected images, D-Lighting creates copies that have been processed to brighten shadows. Use to retouch dark or backlit JPEG photographs (NEF/RAW images can not be retouched;  125).



Before



After

Press ◀ or ▶ to highlight an image ( 112) and press  to display the options shown at right. Press ▲ or ▼ to choose the amount of correction performed (the effect can be previewed in the display) and press  to create a retouched copy.

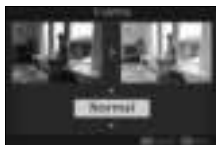

D-Lighting

Noise (randomly-spaced bright pixels, fog, or lines) may appear in copies created with **D-Lighting**. Uneven shading may be visible with some subjects.



Image Size

Copies are the same size as the original.

Resize

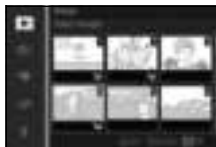
Create small copies of selected JPEG photographs (NEF/RAW images can not be resized;  125). Select **Choose size** and choose a size from **1280×856; 1.1 M** (1280 × 856 pixels), **960×640; 0.6 M** (960 × 640 pixels), and **640×424; 0.3 M** (640 × 424



pixels), and then choose **Select images**. Press ◀ or ▶ to highlight pictures ( 112) and press ▼ to select or deselect. When the selection is complete, press  to display a confirmation dialog and select **Yes** to save the resized copies.

Resized Copies

Playback zoom may not be available with resized copies.



Crop

Create cropped copies of selected JPEG photographs (NEF/RAW images can not be cropped;  125).

Select images	To select an image for trimming, choose Select images , highlight a picture ( 112), and press OK .
Aspect ratio	Choose from aspect ratios of 3 : 2, 4 : 3, 1 : 1, and 16 : 9.

The selected image will be displayed with a default crop of the selected aspect ratio shown in yellow. Use the controls below to size and position the crop and save the copy.

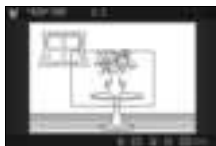

To	Use	Description
Decrease crop size		Rotate the multi selector counterclockwise to decrease the size of the crop.
Increase crop size		Rotate the multi selector clockwise to increase the size of the crop.
Position crop		Press ▲ , ▼ , ◀ , or ▶ to position the crop.
Create copy		Save the current crop as a separate file.

Cropped Copies

Playback zoom may not be available with cropped copies. The size of the copy varies with crop size and aspect ratio and appears at upper left in the crop display.

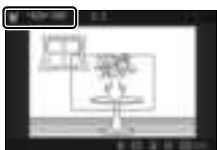

Face-Priority Zoom

If **On** is selected, ◀ and ▶ can be used during playback zoom to select faces detected with face priority. If **Off** is selected, ◀ and ▶ can be used with ▲ and ▼ to scroll the display.

Edit Movie

Trim footage from movies to create edited copies.

1 Choose an edit option.

Highlight one of the following options and press ▶:

- **Choose start point:** Remove all frames before a chosen starting frame.

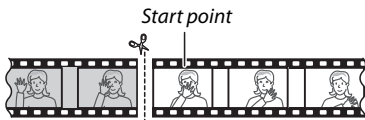

- **Choose end point:** Remove all frames after a chosen closing frame.

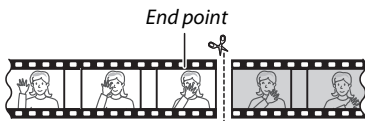

2 Select a movie.

Press ◀ or ▶ to highlight a movie (📖 112) and press Ⓞ to select.

3 Pause the movie on opening or closing frame.

Play the movie back, pressing **OK** to begin and resume playback and **▼** to pause (see 51; the first frame is indicated by a **▶** icon in the display, the last frame by **◀**). While playback is paused, press **◀** or **▶** to rewind or advance one frame at a time. Pause playback when you reach the frame that will become the new opening or closing frame.



4 Delete the unwanted frames.

Press **▲** to delete all frames before (**Choose start point**) or after (**Choose end point**) the current frame.



5 Save the copy.

Highlight **Yes** and press **OK** to save the edited copy. If necessary, the copy can be trimmed as described above to remove additional footage.



✓ Trimming Movies

Movies must be at least two seconds long. If a copy can not be created at the current playback position, the current position will be displayed in red in Step 4 and no copy will be created. The copy will not be saved if there is insufficient space available on the memory card.

To prevent the camera from turning off unexpectedly, use a fully-charged battery when editing movies.

Combine 4-Second Movies

Combine up to eight 4-second movies into a single movie (4-second movies are recorded using the **4-second movie** option in advanced movie mode; for more information, see page 48).

1 Select movies.

Select 4-second movies as described on page 112. Press ▼ to view or hide the order in which the clips will appear in the final movie. To preview a clip, highlight it and press ▲.



2 Combine the selected movies.

Press Ⓞ. A confirmation dialog will be displayed; select **Yes** to join the selected clips and their audio tracks into a new movie, which is stored separately from its component clips.



Combine NMS Movies

Combine the movie segments of up to eight NMS-format Motion Snapshots (☞ 129) into a single movie.

1 Select Motion Snapshots.

Select Motion Snapshots as described on page 112. Press ▼ to view or hide the order in which the clips will appear in the final movie. To preview the movie portion of the highlighted Motion Snapshot, press ▲.

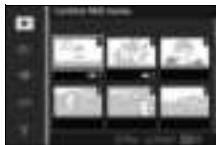

2 Combine the selected Motion Snapshots.

Press Ⓞ. A confirmation dialog will be displayed; select **Yes** to join the movie portions of the selected Motion Snapshots into a new movie, which is stored separately from its component clips. Any audio included in Motion Snapshots recorded with **Audio** (☞ 67) set to **Ambient** will be included in the new movie.



The Shooting Menu





To display the shooting menu, press **MENU** and select **Shooting**.





The shooting menu contains the following options:

Option	Description	Default	
Reset shooting options	Reset shooting options to default values.	—	124
Creative	Choose a creative mode.	Creative Palette	33
Best moment capture	Choose from Active Selection and Smart Photo Selector .	Active Selection	54
Exposure mode	Choose how the camera sets shutter speed and aperture in Motion Snapshot mode (64) and when Active Selection is chosen in best moment capture mode (54).	Scene auto selector	124
Image quality	Choose a file format and compression ratio.	JPEG fine	125
Image size	Choose a size for new photos.	4592×3072; 14.1 M	125
Active Selection	Choose the frames Active Selection (54) records to temporary storage, the length of time over which the frames are captured, and the default number of frames saved.	On release, record: Preceding and following Capture 10 frames over: 1s Frames saved (default): 1	127



Option	Description	Default	
Number of shots saved	Choose the number of shots selected by the Smart Photo Selector ( 58).	5	127
Movie before/after	Choose when the movie portion of Motion Snapshots is recorded ( 64).	1.0 s : 0.6 s	128
File format	Choose a file format for new Motion Snapshots ( 64).	NMS files	129
Audio	Choose the audio recorded with Motion Snapshots ( 64).	Background music	67
Select color	Choose the hue that appears in color in pictures taken with Selective color selected in creative mode.	—	43
Soft	Choose amount of softening applied to pictures taken with Soft selected in creative mode. You can also choose how softening applies to pictures with portrait subjects.	Filter strength: Normal Portrait: On	129
Hue	Choose base hue for pictures taken with Cross process selected in creative mode.	Blue	44
Toy camera effect	Adjust saturation and vignetting for pictures taken with Toy camera effect selected in creative mode.	Saturation: Normal Vignetting: Normal	130
Metering	Choose how the camera meters exposure.	Matrix	130
Auto distortion control	Choose whether the camera corrects barrel and pin-cushion distortion.	Off	131



Option	Description	Default	
Active D-Lighting	Avoid loss of detail in highlights and shadows.	On	132
Long exposure NR	Reduce noise in long time-exposures.	Off	133
Optical VR	Choose whether to use optical vibration reduction with compatible 1 NIKKOR lenses.	On	133
Electronic VR	Choose whether to use electronic vibration reduction in Motion Snapshot mode ( 64). This feature is available even if vibration reduction is not offered by the attached 1 NIKKOR lens.	Off	134
Focus mode	Choose how the camera focuses.	See page 135	134
AF-area mode	Choose how the focus area is selected.	Auto-area	138
Face-priority	Turn face priority on or off.	On	140
Built-in AF assist	Control the built-in AF-assist illuminator.	On	140
Flash control	Choose a flash mode for the built-in flash.	TTL (Manual: Full)	141
Flash compensation	Control flash output.	0.0	142
Underwater flash	Choose Enable when using an optional underwater flash unit.	Disable	142



Reset Shooting Options

Select **Yes** to reset the options in the shooting menu and other shooting settings to default values (☞ 121, 183).

Exposure Mode

The options in the exposure mode menu offer varying degrees of control over shutter speed and aperture in Motion Snapshot and advanced movie modes (☞ 45, 48) and when **Active Selection** is chosen in best moment capture mode (☞ 54).

 Scene auto selector	An automatic, “point-and-shoot” mode in which the camera not only chooses shutter speed and aperture but adjusts other settings to suit the subject (automatic scene selection; ☞ 27).
P Programmed auto	The camera sets shutter speed and aperture for optimal exposure (☞ 35). Recommended for snapshots and in other situations in which there is little time to adjust camera settings.
S Shutter-priority auto	You choose the shutter speed; the camera selects an aperture for best results (☞ 36). Use to freeze or blur motion.
A Aperture-priority auto	You choose the aperture; the camera selects a shutter speed for best results (☞ 37). Use to blur the background or bring both foreground and background into focus.
M Manual	You control both shutter speed and aperture (☞ 38). Set shutter speed to “Bulb” for long time-exposures.





Image Quality

Choose a file format and compression ratio for photographs.

Option	File type	Description
NEF (RAW)	NEF	Compressed 12-bit raw data from the image sensor are saved directly to the memory card. White balance, contrast, and other settings can be adjusted on a computer after shooting.
JPEG fine	JPEG	Record JPEG images at a compression ratio of roughly 1 : 4 (fine quality).
JPEG normal		Record JPEG images at a compression ratio of roughly 1 : 8 (normal quality).

Image Size

Choose the size of photographs.

Option	Size (pixels)	Approximate print size at 300 dpi (cm/in.)*
 4592×3072; 14.1 M	4592 × 3072	38.9 × 26/ 15.3 × 10.2
 3440×2296; 7.9 M	3440 × 2296	29.1 × 19.4/ 11.5 × 7.6
 2288×1528; 3.5 M	2288 × 1528	19.4 × 12.9/ 7.6 × 5.1

*Print size in inches equals image size in pixels divided by printer resolution in dots per inch (dpi; 1 inch = approximately 2.54 cm).



NEF (RAW)

The option selected for image size does not affect the size of NEF (RAW) images. NEF (RAW) images can be viewed on the camera or using software such as Capture NX 2 (available separately; □ 172) or ViewNX 2 (supplied).

File Names

Photos and movies are stored as image files with names of the form “xxx_nnnn.yyy,” where:

- xxx is either NMS (Motion Snapshots recorded with **NMS files** selected for **File format**; □ 129) or DSC (photos, MOV-format Motion Snapshots, and movies, including copies created with **Edit movie**; □ 117),
- nnnn a four-digit number between 0001 and 9999 assigned automatically in ascending order by the camera, and
- yyy one of the following three letter extensions: “NEF” for NEF (RAW) images, “JPG” for JPEG images, or “MOV” for movies.

Trimmed copies created with **Edit movie** (□ 117) have file names beginning with “DSC”; copies created with the other retouch options in the playback menu have file names beginning with “CSC” (e.g., “CSC_0001.JPG”).

Image Quality and Size

Together, image quality and size determine how much space each photograph occupies on the memory card. Larger, higher quality images can be printed at larger sizes but also require more memory, meaning that fewer such images can be stored on the memory card (□ 184).



Active Selection

Choose the frames Active Selection (📖 54) records to temporary storage, the length of time over which the frames are captured, and the default number of frames saved.

■ ■ On Release, Record

Choose the frames copied from the buffer to temporary storage when the shutter-release button is pressed all the way down.

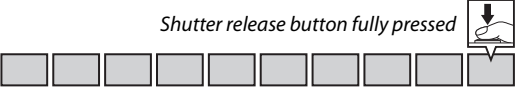
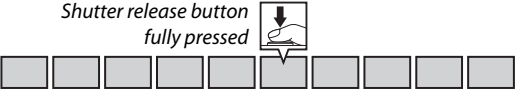
Preceding frames	The camera captures the 10 preceding frames. <i>Shutter release button fully pressed</i> 
Preceding and following	The camera captures the 5 preceding frames and 5 following frames. <i>Shutter release button fully pressed</i> 

■ ■ Capture 10 Frames Over

Choose whether the frames are captured over $\frac{1}{2}$ s (a frame rate of 20 fps) or over 1 s (10 fps).

■ ■ Frames Saved (Default)

Choose the number of frames selected by default in the confirmation dialog displayed when shooting is complete: the frame recorded to the buffer when the shutter-release button was pressed (**1**) or all the frames in temporary storage (**All**).



Number of Shots Saved

Choose the number of shots selected by the Smart Photo Selector. If **5** is selected, the camera will save the best shot and 4 best shot candidates. If **1** is selected, the camera will save only the best shot.

Movie Before/After

Choose whether the movie portions of Motion Snapshots end when the shutter-release button is pressed all the way or about 0.6 s after (📖 64). If **1.6 s : 0 s** is selected, the photograph used for the Motion Snapshot will feature the last frame of the movie.

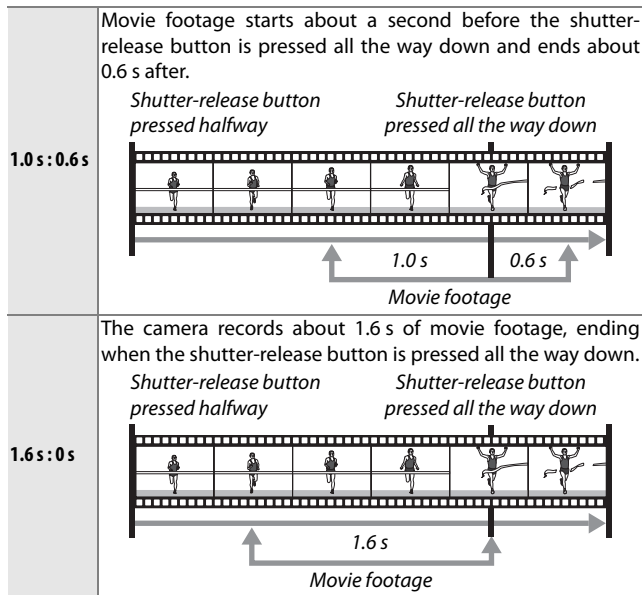

File Format

Choose the file format for Motion Snapshots (📖 64).

NMS files	Motion Snapshots are recorded as a 4 s MOV file and a JPEG image. Motion Snapshots can only be viewed on the camera or using ViewNX 2 (📖 97).
MOV file	Motion Snapshots are recorded as a 10 s MOV file that can be viewed in a variety of computer applications. The Motion Snapshot is not displayed automatically when shooting ends (📖 65); for information on viewing Motion Snapshot movies, see page 51.

Soft

Choose amount of softening applied to pictures taken with **Soft** selected in creative mode. You can also choose how softening applies to portrait subjects.

■ ■ Filter strength

Choose from **High**, **Normal**, and **Low**.

■ ■ Portrait

If **On** is selected and the camera detects portrait subjects (up to three), softening will be adjusted to make them stand out. If **Off** is selected, softening will be applied equally to the portrait subject and the background.



Toy Camera Effect

Adjust saturation and vignetting for pictures taken with **Toy camera effect** selected in creative mode.

■ Saturation





Choose from **High**, **Normal**, and **Low**.

■ Vignetting

Choose the amount of vignetting from **High**, **Normal**, and **Low**.

Metering

Choose how the camera sets exposure.

 Matrix	The camera meters a wide area of the frame and adjusts for contrast (tone distribution), color, composition, and subject distance, producing natural results in most situations.
 Center-weighted	The camera meters the entire frame but assigns the greatest weight to the center area. This is the classic meter for portraits and is recommended if you are using filters with an exposure factor (filter factor) over 1x.
 Spot	The camera meters the current focus area; use to meter off-center subjects (if Auto-area is selected for AF-area mode as described on page 138, the camera will meter the center focus area, while during face priority the camera will meter the focus area closest to the center of the selected face;  28). Spot metering ensures that the subject will be correctly exposed, even when framed against a background that is much brighter or darker.



Auto Distortion Control

Reduce distortion caused by the optical characteristics of the lens. The options available depend on the type of lens attached. If the following options are displayed, choose a setting according to whether the camera is being used on land or under water. Note that underwater use requires a WP-N3 waterproof case (available separately).

On (above water)	Reduce barrel distortion in pictures taken with wide-angle lenses and pin-cushion distortion in pictures taken with long lenses.
On (underwater)	Reduce pin-cushion distortion in pictures taken underwater.
Off	Auto distortion control off.

If the following options are displayed, you can choose whether to enable auto distortion control:

On	Reduce barrel distortion in pictures taken with wide-angle lenses and pin-cushion distortion in pictures taken with long lenses.
Off	Auto distortion control off.

Auto distortion control is available only with 1 NIKKOR lenses and not with NIKKOR lenses attached using the FT1 mount adapter (☞ 171, 203). Results are not guaranteed with third-party lenses. Note that when auto distortion control is enabled, the edges of photographs may be cropped out and there may be an increase in the time needed to process images before they are saved.



Active D-Lighting

Active D-Lighting preserves details in highlights and shadows for natural contrast. Use with high contrast scenes such as a brightly lit outdoor view framed in a door or window or a subject in the shade on a sunny day. It is most effective when used with **Matrix** metering (☐ 130).



Active D-Lighting: Off



Active D-Lighting: ☑ On

☑ Active D-Lighting

Noise (randomly-spaced bright pixels, fog, or lines) may appear in photographs taken with Active D-Lighting. Uneven shading may be visible with some subjects.

✎ “Active D-Lighting” Versus “D-Lighting”

The **Active D-Lighting** option in the shooting menu adjusts exposure before shooting to optimize the dynamic range, while the **D-Lighting** option in the playback menu (☐ 114) brightens shadows in images after shooting.



Long Exposure NR

Photographs taken at slow shutter speeds are automatically processed to reduce “noise” (bright spots, randomly-spaced bright pixels, or fog), slightly increasing recording times. Selecting **On** increases the amount of noise reduction performed at shutter speeds slower than 1 s and increases the time required to record images by roughly 1.5 to 2 times. During processing, a warning will be displayed and pictures can not be taken (if the camera is turned off before processing is complete, the picture will be saved but noise reduction will not be performed). In continuous release mode, frame rates will slow and while photographs are being processed, the capacity of the memory buffer will drop.

Optical VR

Choose **On** to use optical vibration reduction with compatible 1 NIKKOR lenses.

Vibration Reduction

When the camera is panned, vibration reduction applies only to motion that is not part of the pan (if the camera is panned horizontally, for example, vibration reduction will be applied only to vertical shake), making it much easier to pan the camera smoothly in a wide arc. The composition may appear to change after the shutter is released, but this does not indicate a malfunction.

Optical VR

If the lens supports both normal and active vibration reduction, selecting **On** will enable active vibration, reducing both the relatively mild camera shake that occurs when the photographer is stationary and the strong camera shake associated with shooting from a moving vehicle or while walking.



Electronic VR

Select **On** to enable electronic vibration reduction in Motion Snapshot mode (□ 64), when filming movies in auto and creative modes, and when **HD movie** is selected in advanced movie mode (□ 48, but note that electronic VR is not available when **1080/60p** or **720/60p** is selected for **Frame size/frame rate**). This feature is available even if the attached 1 NIKKOR lens does not support vibration reduction. Note that there will be a slight delay before recording begins and that the edges of the image will be cropped out when **On** is selected.

Focus Mode

Choose how the camera focuses.

AF-A	Auto-select AF: The camera automatically selects AF-S if the subject is stationary, AF-C if it is moving.
AF-S	Single AF: For stationary subjects. Focus locks when the shutter-release button is pressed halfway.*
AF-C	Continuous AF: For subjects in motion. The camera focuses continuously on the subject in the AF-area brackets while the shutter-release button is pressed halfway (note that the AF-area brackets appear only in the detailed display; □ 165). Photos can be taken whether or not the camera is in focus.
AF-F	Full-time AF: For subjects in motion. The camera focuses continuously; photos can be taken whether or not the camera is in focus.
MF	Manual focus: Focus manually (□ 136). Photos can be taken whether or not the camera is in focus.







AF-area brackets

* Shutter can only be released if camera is able to focus.

Focus Mode

The options available vary as shown below.

Menu		Focus mode
Shooting		AF-A (default), AF-S, AF-C, MF
Movies	 HD movie,  Fast motion,	AF-F (default), AF-S, MF
	 Jump cut,  4-second movie	
	 Slow motion	AF-S (default), MF

Getting Good Results with Autofocus

Autofocus does not perform well under the conditions listed below. The shutter release may be disabled if the camera is unable to focus under these conditions, or the focus area may be displayed in green and the camera may sound a beep, allowing the shutter to be released even when the subject is not in focus. In these cases, focus manually (📖 136) or use focus lock (📖 139) to focus on another subject at the same distance, and then recompose the photograph.

There is little or no contrast between the subject and the background.

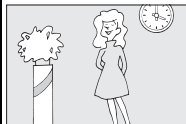

Example: The subject is the same color as the background.

The subject contains areas of sharply contrasting brightness.

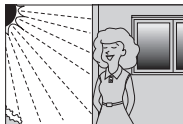

Examples: The subject is half in the shade; a night scene with point illumination.

The subject contains objects at different distances from the camera.



Example: The subject is inside a cage.

Background objects appear larger than the subject.

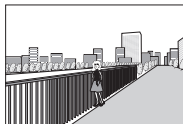

Example: A building is in the frame behind the subject.

The subject is dominated by regular geometric patterns.

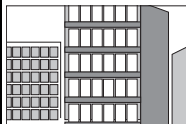

Example: Blinds or a row of windows in a skyscraper.

The subject contains many fine details or is made up of objects that are small or lack variation in brightness.

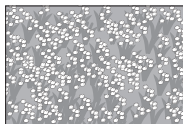

Example: A field of flowers.





See Also

See page 166 for information on controlling the beep that sounds when the camera focuses.

Manual Focus

Manual focus can be used when autofocus does not produce the desired results.

1 Select manual focus.

Highlight **Manual focus** in the focus mode menu ( 134) and press .



2 Choose a magnification.

Highlight an option and press . Choose from **10x zoom**, **5x zoom**, **2x zoom**, and **1x zoom** (zoom off).



3 Display the manual focus guides.

In the shooting display, press  to magnify the view at the center of the frame by the amount selected in Step 2 (this feature is not available during movie recording or in slow-motion movie mode). Manual focus guides are also displayed.



4 Focus.

Rotate the multi selector until the subject is in focus. Rotate the multi selector clockwise to increase the focus distance, counterclockwise to decrease; the faster you rotate the multi selector, the quicker the focus distance changes. The focus indicator shows the approximate focus distance. Press OK when the subject is in focus.

Press \blacktriangle , \blacktriangledown , \blacktriangleleft , or \blacktriangleright to view areas of the frame not currently visible in the display; the visible portion is shown by the navigation window.



Focus indicator

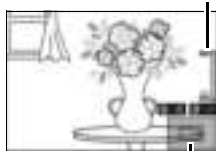

Navigation window

Movies

The multi selector can also be used to choose the focus distance if manual focus is selected prior to movie recording. Rotate the multi selector clockwise to increase the focus distance, counterclockwise to decrease; the faster you rotate the multi selector, the quicker the focus distance changes.

Focal Plane Position

To determine the distance between your subject and the camera, measure from the focal plane mark on the camera body. The distance between the lens mounting flange and the focal plane is approximately 17 mm (0.7 in.).

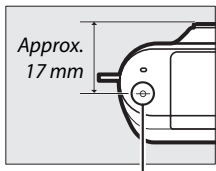









Focal plane mark

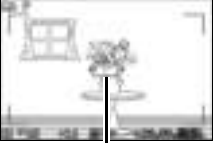

AF-Area Mode

Choose how the focus area for autofocus is selected.

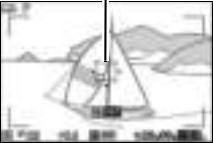
 Auto-area	The camera automatically detects the subject and selects the focus area.
 Single-point	<p>Press  to view the focus area selection display, then use the multi selector to position the focus area over your subject and press ; the camera focuses on the subject in the selected focus area only. Use with stationary subjects.</p>  <p><i>Focus area</i></p>
 Subject tracking	<p>Press  to view the focus area selection display, then use the multi selector to position the focus area over your subject and press . The focus area will track the subject as it moves through the frame. The camera will focus on the selected subject when the shutter-release button is pressed halfway. To end focus tracking when shooting is complete, press .</p>  <p><i>Focus area</i></p>

Subject Tracking

The camera may be unable to track subjects if they move quickly, leave the frame or are obscured by other objects, change visibly in size, color, or brightness, or are too small, too large, too bright, too dark, or similar in color or brightness to the background.

Focus Lock

When **Single AF** is selected for **Focus mode** (📖 134), focus lock can be used to change the composition after focusing on the subject in the center of the frame, allowing you to focus on a subject that will not be in the center of the final composition. If the camera is unable to focus using autofocus (📖 135), you can also focus on another subject at the same distance and then use focus lock to recompose the photograph. Focus lock is most effective when an option other than **Auto-area** is selected for **AF-area mode** (📖 138).

1 Lock focus.

Position the subject in the center of the frame and press the shutter-release button halfway to initiate focus. Check that the focus area is displayed in green. Focus will remain locked while the shutter-release button is pressed halfway.

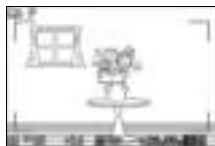

2 Recompose the photograph and shoot.

Focus will remain locked between shots.

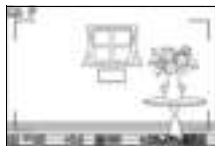

Do not change the distance between the camera and the subject while focus lock is in effect. If the subject moves, lift your finger from the shutter-release button to end focus lock and then focus again at the new distance.



Face-Priority

Choose **On** to enable face priority (📖 28).

Built-in AF Assist

When **On** is selected, the built-in AF-assist illuminator will light to illuminate poorly-lit subjects if:

- **AF-S** is selected for focus mode (📖 134) or single AF is selected in **AF-A**, and
- **Auto-area** or **Single-point** is selected for **AF-area mode** (📖 138).

AF-assist illuminator

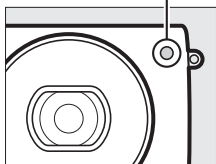

The AF-assist illuminator will not light to assist the focus operation in advanced movie mode, during movie recording, or when **Off** is selected. If the AF-assist illuminator does not light, autofocus may not produce the desired results when lighting is poor.



The AF-Assist Illuminator

Larger lenses may prevent the illuminator lighting all or part of the subject. Remove lens hoods when using the illuminator.



Flash Control

Choose a flash control mode for the built-in flash.

TTL  TTL	Flash output is adjusted automatically in response to shooting conditions (i-TTL flash control).
M  Manual	<p>Choose a flash level between Full and 1/32 (1/32 of full power). At full power, the built-in flash has a guide number of about 5/16 (m/ft, ISO 100, 20 °C/68 °F; at ISO 200, the guide number is about 7/23).</p> <p>A  icon flashes in the display during flash photography when this option is selected.</p>

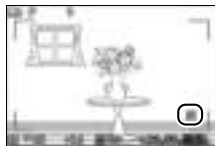

Flash Compensation

Flash compensation alters flash output from the level suggested by the camera, changing the brightness of the main subject relative to the background. Choose from values between -3 EV (darker) and $+1$ EV (brighter) in increments of $\frac{1}{3}$ EV; in general, positive values make the subject brighter while negative values make it darker.

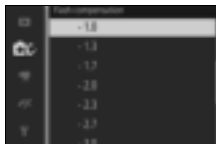

A  icon is displayed when flash compensation is in effect. Normal flash output can be restored by setting flash compensation to ± 0 . Flash compensation is not reset when the camera is turned off.

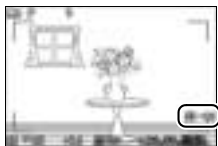

Underwater Flash

Choose **Enable** when using an optional underwater flash unit.



The Movie Menu

To display the movie menu, press **MENU** and select **Movies**.

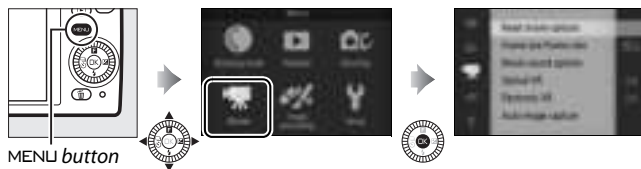

The movie menu contains the following options:

Option	Description	Default	
Reset movie options	Reset movie menu options to their default values.	—	145
Advanced movie	Choose a movie type for advanced movie mode.	HD movie	48
Exposure mode	Choose how the camera sets exposure in advanced movie mode.	Scene auto selector	124
Slow motion	Choose a frame rate for slow-motion movies recorded in advanced movie mode (48).	400 fps	145
Frame size/ frame rate	Choose a frame size and rate for movies recorded in auto and creative modes and when HD movie is selected in advanced movie mode (48).	1080/30p	146
Metering	Choose how the camera meters exposure.	Matrix	130
Movie sound options	Choose sound recording options.	Microphone: Auto sensitivity (A) Wind noise reduction: On	147

Option	Description	Default	
Optical VR	Choose whether to use optical vibration reduction with compatible 1 NIKKOR lenses.	On	133
Electronic VR	Choose whether to use electronic vibration control when recording movies. This feature is available even if vibration reduction is not offered by the attached 1 NIKKOR lens.	On	134
Focus mode	Choose how the camera focuses.	See page 135	134
AF-area mode	Choose how the focus area is selected.	Auto-area ¹	138
Face-priority	Turn face priority on or off.	On ²	140
Auto image capture	Choose whether the camera takes photos automatically during movie recording and select the number of pictures taken per minute.	Auto photography: Off Max. shots per minute: 4	147

1 The camera focuses on the subject in the center of the frame when  **Slow motion** is selected in advanced movie mode.

2 Face detection is not available when  **Slow motion** is selected in advanced movie mode.



Reset Movie Options

Select **Yes** to reset the options in the movie menu to default values (☐ 143).

Slow Motion

Choose a frame rate for slow-motion movies (☐ 48). The faster the frame rate, the smaller the frame size.

Option	Frame size (pixels)	Bit rate ¹	Maximum length (shooting) ¹	Maximum length (playback) ^{1,2}
400 fps	640 × 240	2 Mbps	2 seconds	26 seconds
1200 fps	320 × 120	1 Mbps		80 seconds

1 All figures are approximate.

2 Slow-motion movies will play back over a period of about 13 (400 fps) or 40 (1200 fps) times the recording time.

See Also

For information on the total length of movies that can be stored on the memory card, see page 185.



Frame Size/Frame Rate

Choose a frame size and frame rate for movies recorded in auto and creative modes and when **HD movie** is selected in advanced movie mode (📖 48).





Option	Frame size (pixels)	Recording rate	Bit rate (approx.)	Maximum length
 1080/60p	1920 × 1080	59.94 fps	42 Mbps	10 minutes
 1080/30p		29.97 fps	24 Mbps	20 minutes
 720/60p	1280 × 720	59.94 fps	16 Mbps	29 minutes
 720/30p		29.97 fps	12 Mbps	

Photo Frame Size

Photographs recorded by pressing the shutter-release button all the way down during movie recording have an aspect ratio of 3 : 2. The frame size varies with the option selected for **Frame size/frame rate**:

- **1080/60p and 1080/30p**: 4592 × 3072 pixels
- **720/60p and 720/30p**: 1280 × 856 pixels

See Also

For information on the total length of movies that can be stored on the memory card, see page 185.



Movie Sound Options

Adjust movie sound recording settings for the built-in microphone.

Microphone

Select **Microphone off** to disable sound recording. Selecting any other option enables recording and sets the microphone to the selected sensitivity.

The Icon

Movies recorded with the microphone off are indicated by a  icon in full-frame and movie playback.

Wind Noise Reduction

Select **On** to enable the low-cut filter, reducing noise produced by wind blowing over the microphone (note that other sounds may also be affected).

Auto Image Capture

Choose whether the camera takes photos automatically while movies are being recorded in auto or creative mode or with **HD movie** selected in advanced movie mode. Photos will be taken when a suitably-framed portrait subject is in focus and the composition is stable. The maximum number of photos that can be taken during a single clip is ten, including photos taken manually (📖 50).

Auto photography	The camera will take photos automatically during movie recording if On is selected.
Max. shots per minute	Choose the maximum number of shots per minute (one or four).



The Image Processing Menu

To display the image processing menu, press **MENU** and select **Image processing**.



The image processing menu contains the following options:

Option	Description	Default	
Reset processing options	Reset image processing options to their default values.	—	149
White balance	Adjust settings for different types of lighting.	Auto	149
ISO sensitivity	Control the camera's sensitivity to light.	Auto (200–6400)	154
Picture Control	Choose how the camera processes pictures.	Standard	155
Custom Picture Control	Create custom Picture Controls.	—	159
High ISO noise reduction	Reduce noise at high ISO sensitivities.	On	161









Reset Processing Options

Select **Yes** to reset the options in the image processing menu to default values (☞ 148).

White Balance

White balance ensures that colors are unaffected by the color of the light source. Auto white balance is recommended for most light sources, but other values can be selected if necessary according to the type of source.

AUTO Auto	Automatic white balance adjustment. Recommended in most situations.
 Incandescent	Use under incandescent lighting.
 Fluorescent	Use with cool-white fluorescent lighting.
 Direct sunlight	Use with subjects lit by direct sunlight.
 Flash	Use with built-in flash.
 Cloudy	Use in daylight under overcast skies.
 Shade	Use in daylight with subjects in the shade.
 Underwater	Choose when taking pictures underwater using an optional WP-N3 waterproof case (☞ 171).
PRE Preset manual	Measure white balance (☞ 151).



Fine-Tuning White Balance

Options other than **Preset manual** can be fine-tuned as follows:

1 Display fine-tuning options.

Highlight an option other than **Preset manual** and press **▶** to display the fine-tuning options shown at right.

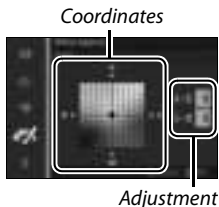

2 Fine-tune white balance.

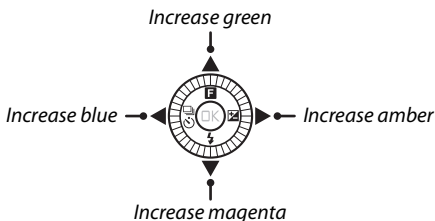

Use the multi selector to fine-tune white balance.



White Balance Fine Tuning

The colors on the fine-tuning axes are relative, not absolute. For example, moving the cursor to **B** (blue) when a “warm” setting such as  (incandescent) is selected will make photographs slightly “colder” but will not actually make them blue.

3 Save changes and exit.

Press **ⓄK**. An asterisk will appear next to the white balance icon ( 4) in the detailed display ( 165) to show that white balance has been altered from default values.

Preset Manual

Preset manual is used to record and recall custom white balance settings for shooting under mixed lighting or to compensate for light sources with a strong color cast.

1 Light a reference object.

Place a neutral gray or white object under the lighting that will be used in the final photograph. A standard gray panel can be used for increased precision.

2 Select Preset manual.

Highlight **Preset manual** in the white balance menu and press ►. The dialog shown at right will be displayed; highlight **Yes** and press **OK** to overwrite the existing value for preset manual white balance.

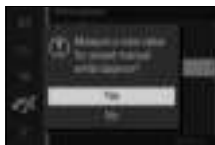

The message shown at right will be displayed.



3 Measure white balance.

When the camera is ready to measure white balance, a flashing PRE will be displayed. Before the indicator stops flashing, frame the reference object so that it fills the display and press the shutter-release button all the way down. No photograph will be recorded; white balance can be measured accurately even when the camera is not in focus.

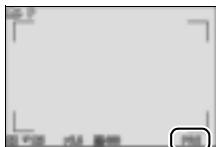

4 Check the results.

If the camera was able to measure a value for white balance, the message shown at right will be displayed. To return to shooting mode immediately, press the shutter-release button half-way.



If lighting is too dark or too bright, the camera may be unable to measure white balance. The message at right will be displayed. Return to Step 3 and measure white balance again.



☑ Auto Power Off

White balance measurement will end without a new value being acquired if no operations are performed for the time selected for **Auto power off** in the setup menu (☐ 166; the default is 1 minute).

☑ Preset White Balance

The camera can store only one value for preset white balance at a time; the existing value will be replaced when a new value is measured. Note that exposure is automatically increased by 1 EV when measuring white balance; in mode **M**, adjust exposure so that the exposure indicator shows ± 0 (☐ 38).

☑ Color Temperature

The perceived color of a light source varies with the viewer and other conditions. Color temperature is an objective measure of the color of a light source, defined with reference to the temperature to which an object would have to be heated to radiate light in the same wavelengths. While light sources with a color temperature in the neighborhood of 5000–5500 K appear white, light sources with a lower color temperature, such as incandescent light bulbs, appear slightly yellow or red. Light sources with a higher color temperature appear tinged with blue. The camera white balance options are adapted to the following color temperatures (all figures are approximate):

- | | |
|--|---------------------------------------|
| • Sodium-vapor lamps: 2700 K | • ☀ (direct sunlight): 5200 K |
| • ⚡ (incandescent)/
Warm-white fluorescent: 3000 K | • ⚡ (flash): 5400 K |
| • White fluorescent: 3700 K | • ☁ (cloudy): 6000 K |
| • ☀ (cool-white fluorescent): 4200 K | • Daylight fluorescent: 6500 K |
| • Day white fluorescent: 5000 K | • Mercury-vapor lamps: 7200 K |
| | • 🏠 (shade): 8000 K |



ISO Sensitivity

The camera's sensitivity to light can be adjusted according to the amount of light available. The higher the ISO sensitivity, the less light needed to make an exposure, allowing faster shutter speeds or smaller apertures.

A6400 Auto (200–6400) A3200 Auto (200–3200) A800 Auto (200–800)	The camera adjusts ISO sensitivity in response to lighting conditions. ISO sensitivity is adjusted in the range given in brackets; choose larger ranges for increased sensitivity when lighting is poor, smaller ranges to reduce noise (randomly-spaced bright pixels, fog, or lines).
200, 400, 800, 1600, 3200, 6400, 12800, 12800 (NR)	ISO sensitivity is fixed at the selected value. If 12800 (NR) is selected, the camera will take four shots each time the shutter-release button is pressed all the way down and combine them to create a single image processed to reduce the noise that occurs at high sensitivities.

"Auto" ISO Sensitivity Options

When auto ISO sensitivity control is in effect, the display shows an **ISO AUTO** icon and the current ISO sensitivity.

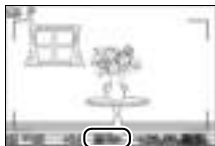







12800 (NR)

The edges of the image will be cropped out and the built-in flash and Active D-Lighting can not be used. The desired results may not be achieved if the camera or subject moves during shooting. If NEF (RAW) is selected for image quality, the picture will be recorded as a fine-quality JPEG image. Only one shot will be taken if the shutter speed is slower than $\frac{1}{30}$ s.



Picture Control

Choose how the camera processes photographs.

 SD Standard	Standard processing for balanced results. Recommended in most situations.
 NL Neutral	Minimal processing for natural results. Choose for photographs that will later be extensively processed or retouched.
 VI Vivid	Pictures are enhanced for a vivid, photoprint effect. Choose for photographs that emphasize primary colors.
 MC Monochrome	Take monochrome photographs.
 PT Portrait	Process portraits for natural texture and a rounded feel.
 LS Landscape	Take vibrant photographs of landscapes and cityscapes.

Modifying Picture Controls

Existing preset and custom Picture Controls (📖 159) can be modified to suit the scene or your creative intent.

1 Display options.

Highlight an item in the Picture Control menu and press ► to display Picture Control settings (📖 157; the settings available with custom Picture Controls are the same as the preset controls on which they are based). To use an unmodified Picture Control, highlight it and press Ⓚ.



2 Adjust settings.

Press ▲ or ▼ to highlight the desired setting and press ◀ or ▶ to choose a value. Repeat this step until all settings have been adjusted, or select **Quick adjust** to choose a preset combination of settings. Default settings can be restored by pressing the  button.



3 Save changes and exit.

Press .

Preset Picture Controls Versus Custom Picture Controls

The Picture Controls supplied with the camera are referred to as *preset Picture Controls*. *Custom Picture Controls* are created through modifications to existing Picture Controls using the **Custom Picture Control** option in the image processing menu ([□ 159](#)). If desired, custom Picture Controls can be saved to a memory card and copied to other Nikon 1 S2 cameras or loaded into compatible software ([□ 160](#)).

Modified Picture Controls

Picture Controls that have been modified from default settings are indicated by an asterisk ("*") in the Picture Control menu ([□ 155](#)) and in the detailed display ([□ 165](#)).



Picture Control Settings



Quick adjust		Mute or exaggerate the effect of the selected Picture Control (note that this resets all manual adjustments). Not available with Neutral , Monochrome , or custom Picture Controls.
Manual adjustments (all Picture Controls)	Sharpening	Manually adjust the sharpness of outlines, or select A to adjust sharpness automatically.
	Contrast	Adjust contrast manually, or select A for automatic contrast adjustment.
	Brightness	Adjust brightness without affecting exposure.
Manual adjustments (non-monochrome only)	Saturation	Control the vividness of colors. Select A to adjust saturation automatically.
	Hue	Adjust hue.
Manual adjustments (monochrome only)	Filter effects	Simulate the effect of color filters on monochrome photographs.
	Toning	Choose the tint used in monochrome photographs.

"A" (Auto)

Results for auto sharpening, contrast, and saturation vary with exposure and the size and position of the subject in the frame.



Previous Settings

The line under the value displayed in the Picture Control setting menu indicates the previous value for the setting. Use this as a reference when adjusting settings.



Filter Effects (Monochrome Only)

The options in this menu simulate the effect of color filters on monochrome photographs. The following filter effects are available:

Y (yellow)	Enhance contrast. Can be used to reduce the brightness of the sky in landscape photographs.
O (orange)	Orange produces more contrast than yellow, red more contrast than orange.
R (red)	
G (green)	Softens skin tones. Can be used for portraits.

Note that the effects achieved with **Filter effects** are more pronounced than those produced by physical glass filters.

Toning (Monochrome Only)

Choose from **B&W** (black-and-white), **Sepia**, **Cyanotype** (blue-tinted monochrome), **Red**, **Yellow**, **Green**, **Blue Green**, **Blue**, **Purple**, **Blue**, **Red Purple**. Pressing ▼ when **Toning** is highlighted displays saturation options. Press ◀ or ▶ to adjust saturation. Saturation control is not available when **B&W** (black-and-white) is selected.



Custom Picture Control

The Picture Controls supplied with the camera can be modified and saved as custom Picture Controls.

Edit/Save

To create a custom Picture Control, select **Edit/save** and follow the steps below.

1 Select a Picture Control.

Highlight an existing Picture Control and press **▶**, or press **OK** to proceed to Step 3 to save a copy of the highlighted Picture Control without further modification.



2 Edit the selected Picture Control.

See page 157 for more information. To abandon any changes and start over from default settings, press the **⏏** button. Press **OK** when settings are complete.



3 Save the Picture Control.

Highlight a destination (C-1 through C-9) and press **OK** to save the custom Picture Control and return to the image processing menu.



The new Picture Control will be listed in the **Picture Control** menu.

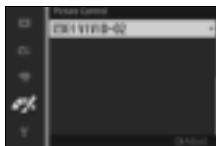

Load from/Save to Card

Custom Picture Controls created using the Picture Control Utility available with ViewNX 2 or optional software such as Capture NX 2 can be copied to a memory card and loaded into the camera, or custom Picture Controls created with the camera can be copied to the memory card to be used in other Nikon 1 S2 cameras and compatible software and then deleted when no longer needed.



To copy custom Picture Controls to or from the memory card, or to delete custom Picture Controls from the memory card, select **Load from/save to card** in the **Custom Picture Control** menu. The following options will be displayed:

Copy to camera	Copy custom Picture Controls from the memory card to custom Picture Controls C-1 through C-9.
Delete from card	Delete selected custom Picture Controls from the memory card. The confirmation dialog shown at right will be displayed before a Picture Control is deleted; to delete the selected Picture Control, highlight Yes and press OK .
Copy to card	Copy a custom Picture Control (C-1 through C-9) to a selected destination (1 through 99) on the memory card.



Copy to Card

Up to 99 custom Picture Controls can be stored on the memory card at any one time. The memory card can only be used to store user-created custom Picture Controls. The preset Picture Controls supplied with the camera can not be copied to the memory card or deleted.

Custom Picture Control > Delete

The **Delete** option in the **Custom Picture Control** menu can be used to delete selected custom Picture Controls from the camera when they are no longer needed.



High ISO Noise Reduction

Select **On** to reduce “noise” (randomly-spaced bright pixels, lines, or fog). If **Off** is selected, noise reduction will still be performed, but the amount is less than that performed when **On** is selected.

The Setup Menu

To display the setup menu, press **MENU** and select **Setup**.



The setup menu contains the following options:

Option	Description	Default	
Reset setup options	Reset setup menu options to default values.	—	164
Format memory card	Format the memory card.	—	164
Slot empty release lock	Allow the shutter to be released when no memory card is inserted in the camera.	Release locked	164
Display	Adjust display brightness, view or hide a framing grid, and choose the information displayed in the monitor.	Display brightness: 0 Grid display: Off Shooting: Simple Playback: Basic info	165
Silent photography	Mute the sounds made during shooting.	Off	166
Sound settings	Choose the sounds made during shooting.	AF: On Self-timer: On	166
Auto power off	Choose the auto power off delay.	1 min	166
Shutter button AE lock	Choose whether exposure locks when the shutter-release button is pressed halfway.	Off	166

Option	Description	Default	
HDMI device control	Choose whether remote controls for HDMI-CEC devices to which the camera is connected can be used to operate the camera.	On	104
Flicker reduction	Reduce flicker or banding.	—	167
Reset file numbering	Reset file numbering.	—	167
Time zone and date	Set the camera clock.	Daylight saving time: Off	168
Language	Choose a language for the camera displays.	—	168
Auto image rotation	Record camera orientation with pictures.	On	169
Wireless mobile adapter*	Enable or disable the wireless mobile adapter.	—	80
Pixel mapping	Check and optimize the camera image sensor and image processors.	—	170
Firmware version	Display the current firmware version.	—	170

* Available only when optional WU-1a wireless mobile adapter is attached.



Reset Setup Options

Select **Yes** to reset all setup menu options other than **Flicker reduction**, **Time zone and date**, and **Language** to default values.

Format Memory Card

Select **Yes** to format the memory card. *Note that this permanently deletes all data on the card, including protected images;* before proceeding, be sure to copy important pictures and other data to a computer (📖 100). To exit without formatting the memory card, highlight **No** and press **OK**.

The message shown at right is displayed while the card is formatted; *do not remove the memory card or remove or disconnect the power source until formatting is complete.*



Slot Empty Release Lock

If **Enable release** is selected, the shutter can be released when no memory card is inserted. No pictures will be recorded, although they will be displayed in demo mode. Select **Release locked** to enable the shutter only when a card is inserted.



Display

Adjust the following display options.

Display Brightness

Press ▲ or ▼ to choose a value for monitor brightness. Choose higher values to brighten the display and lower values to make the display darker.

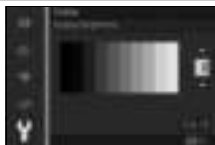

Grid Display

Select **On** to display a framing grid (📖 24).

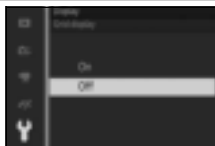

Shooting

Choose the information displayed during shooting (📖 4).

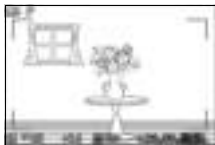

Simple

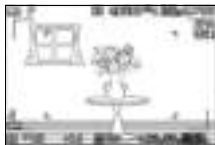

Detailed

Playback

Choose the information displayed during playback (📖 85).

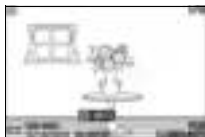

Basic info



Detailed info

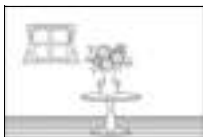

Image only



Silent Photography

Select **On** to mute the sounds made by the camera during shooting.

Sound Settings

Highlight items and press ► to select or deselect. Select **AF** to sound a beep when the camera focuses, **Self-timer** to sound a beep during self-timer photography, or remove the checks to mute these sounds. Press **OK** to exit when settings are complete.

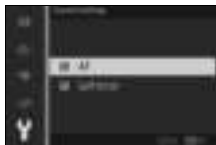

Auto Power Off

Choose how long the display remains on when no operations are performed (📖 17). Choose shorter delays to reduce the drain on the battery. Once the display has turned off, it can be reactivated by pressing the shutter-release button.

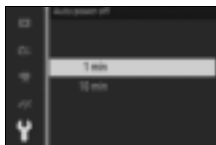

Shutter Button AE Lock

If **On** is selected, exposure will lock while the shutter-release button is pressed halfway.



Flicker Reduction

Reduce flicker and banding in the display and in movies while shooting under fluorescent or mercury-vapor lighting. Choose a frequency which matches that of the local AC power supply.

Flicker Reduction

If you are unsure as to the frequency of the local power supply, test both options and choose the one that produces the best results. Flicker reduction may not produce the desired results if the subject is very bright, in which case you should select mode **A** or **M** and choose a smaller aperture (higher f-number).

Reset File Numbering

When a photograph is taken or a movie is recorded, the camera names the file by adding one to the number of the previous file (📖 126). If the current folder is numbered 999 and contains either 999 photographs or a photograph numbered 9999, the shutter-release button will be disabled and no further photographs can be taken. To reset file numbering to 0001, select **Yes** for **Reset file numbering** and then either format the current memory card or insert a new memory card.



Time Zone and Date

Change time zones, set the camera clock, choose the date display order, or turn daylight saving time on or off (📖 19).



Time zone	Choose a time zone. The camera clock is automatically set to the time in the new time zone.
Date and time	Set the camera clock.
Date format	Choose the order in which the day, month, and year are displayed.
Daylight saving time	Turn daylight saving time on or off. The camera clock will automatically be advanced or set back one hour. The default setting is Off .

Language

Choose a language for camera messages and displays.



Auto Image Rotation

Photographs taken while **On** is selected contain information on camera orientation, allowing them to be rotated automatically during playback or when viewed in ViewNX 2 (supplied) or Capture NX 2 (available separately;  172). The following orientations are recorded:

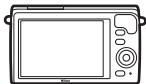

*Landscape (wide)
orientation*



*Camera rotated 90°
clockwise*



*Camera rotated 90°
counterclockwise*

Camera orientation is not recorded when **Off** is selected. Choose this option when panning or taking photographs with the lens pointing up or down.

Auto Image Rotation

Image orientation is not recorded in movie or Motion Snapshot modes.

Rotate Tall

To automatically rotate "tall" (portrait-orientation) photographs for display during playback, select **On** for the **Rotate tall** option in the playback menu ( 113).



Pixel Mapping

Check and optimize the camera image sensor and image processors if you notice unexpected bright spots in your pictures (note that the camera comes with the sensor and processors already optimized). Before performing pixel mapping as described below, check that the battery is fully charged.

1 Attach a lens and lens cap.

Turn the camera off and attach a 1 NIKKOR lens. If the lens is equipped with a cap, do not remove it.

2 Select Pixel mapping.

Turn the camera on, press **MENU**, and select **Pixel mapping** in the setup menu.

3 Select Yes.

Pixel mapping begins immediately. Note that other operations can not be performed while pixel mapping is in progress. *Do not turn the camera off or remove or disconnect the power source until pixel mapping is complete.*

4 Turn the camera off.

Turn the camera off when pixel mapping is complete.

Firmware Version

View the current firmware version.



Technical Notes

Read this chapter for information on compatible accessories, cleaning and storing the camera, and what to do if an error message is displayed or you encounter problems using the camera.

Optional Accessories

At the time of writing, the following accessories were available for your camera.

Lenses	1 mount lenses
Mount adapters	Mount Adapter FT1: The FT1 allows NIKKOR F mount lenses to be used with Nikon 1 interchangeable lens format digital cameras. The angle of view of an F mount lens mounted on the FT1 is equivalent to that of a 35 mm format lens with a focal length about $2.7 \times$ longer. See page 203 for information on using the FT1; be sure to update to the latest version of the FT1 firmware before use. For information on attaching and removing the FT1 and on precautions for use, see the <i>FT1 Mount Adapter User's Manual</i> . For information on the lenses that can be used, see <i>Compatible NIKKOR F Mount Lenses</i> . The <i>FT1 Mount Adapter User's Manual</i> and <i>Compatible NIKKOR F Mount Lenses</i> are included with the FT1.
Power sources	<ul style="list-style-type: none">• Rechargeable Li-ion Battery EN-EL22 (□ 10–12): Additional EN-EL22 batteries are available from local retailers and Nikon-authorized service representatives.• Battery Charger MH-29 (□ 10): Recharge EN-EL22 batteries.• Power Connector EP-5E, AC Adapter EH-5b: These accessories can be used to power the camera for extended periods (EH-5a and EH-5 AC adapters can also be used). An EP-5E power connector is required to connect the camera to the EH-5b, EH-5a, or EH-5; see page 174 for details.
Waterproof cases	Waterproof Case WP-N3: In addition to protecting the camera from rain, snow, and spray, this waterproof case can be used to take photographs underwater.



Underwater flash units	Underwater Speedlight SB-N10: Use with the optional WP-N3 waterproof case.
Software	<p>Capture NX2: A complete photo editing package offering such features as white balance adjustment and color control points.</p> <div style="border: 1px solid black; padding: 5px;"> <p>Note: Use the latest versions of Nikon software; see the websites listed on page xvii for the latest information on supported operating systems. At default settings, Nikon Message Center 2 will periodically check for updates to Capture NX 2 and other Nikon software and firmware while you are logged in to an account on the computer and the computer is connected to the Internet. A message is automatically displayed when an update is found.</p> </div>
Body caps	Body Cap BF-N1000: The body cap keeps the dust shield free of dust when a lens is not in place.
Wireless mobile adapters	Wireless Mobile Adapter WU-1a (☎ 80): Supports two-way communication between the camera and smart devices running the Wireless Mobile Utility app. Use the Wireless Mobile Utility to take pictures remotely or download existing pictures to the smart device.

Optional Accessories

Availability may vary with country or region. See our website or brochures for the latest information.



Approved Memory Cards

The following cards have been tested and approved for use in the camera. Cards with class 6 or faster write speeds are recommended for movie recording. Recording may end unexpectedly when cards with slower write speeds are used.

	microSD cards	microSDHC cards ²	microSDXC cards ³
SanDisk			64 GB
Toshiba	2 GB ¹	4 GB, 8 GB, 16 GB, 32 GB	
Panasonic			—

- 1** Check that any card readers or other devices with which the card will be used support 2 GB cards.
- 2** Check that any card readers or other devices with which the card will be used are SDHC-compliant. The camera supports UHS-I.
- 3** Check that any card readers or other devices with which the card will be used are SDXC-compliant. The camera supports UHS-I.



Other cards have not been tested. For more details on the above cards, please contact the manufacturer.



Attaching a Power Connector and AC Adapter

Turn the camera off before attaching an optional power connector and AC adapter.

1 Ready the camera.

Open the battery-chamber/memory card slot and power connector covers.

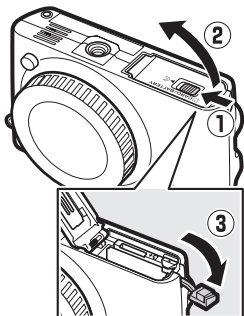

2 Insert the EP-5E power connector.

Be sure to insert the connector in the orientation shown, using the connector to keep the orange battery latch pressed to one side. The latch locks the connector in place when the connector is fully inserted.

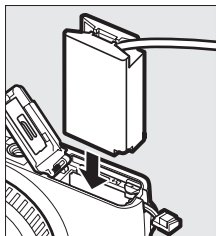

3 Close the battery-chamber/memory card slot cover.

Position the power connector cable so that it passes through the power connector slot and close the battery-chamber/memory card slot cover.

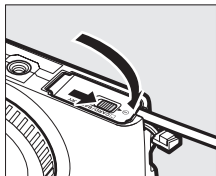

4 Connect the AC adapter.

Connect the AC adapter power cable to the AC socket on AC adapter (①) and the EP-5E power cable to the DC socket (②). A  icon is displayed in the monitor when the camera is powered by the AC adapter and power connector.

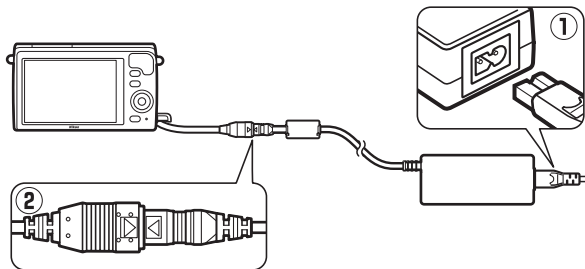

Storage and Cleaning

Storage

If the camera will not be used for an extended period, remove the battery and store it in a cool, dry area with the terminal cover in place. To prevent mold or mildew, store the camera in a dry, well-ventilated area. Do not store your camera with naphtha or camphor moth balls or in locations that:

- are poorly ventilated or subject to humidities of over 60%
- are next to equipment that produces strong electromagnetic fields, such as televisions or radios
- are exposed to temperatures above +50 °C (122 °F) or below -10 °C (14 °F)

Cleaning

Camera body	Use a blower to remove dust and lint, then wipe gently with a soft, dry cloth. After using the camera at the beach or sea-side, wipe off sand or salt with a cloth lightly dampened in distilled water and dry thoroughly. Important: <i>Dust or other foreign matter inside the camera may cause damage not covered under warranty.</i>
Lens	Lenses are easily damaged. Remove dust and lint with a blower. If using an aerosol blower, keep the can vertical to prevent the discharge of liquid. To remove fingerprints and other stains, apply a small amount of lens cleaner to a soft cloth and clean with care.
Monitor	Remove dust and lint with a blower. When removing fingerprints and other stains, wipe the surface lightly with a soft cloth or chamois leather. Do not apply pressure, as this could result in damage or malfunction.
Dust shield	The dust shield is easily damaged. Remove dust and lint with a blower.

Do not use alcohol, thinner, or other volatile chemicals.



Caring for the Camera and Battery: Cautions

Do not drop: The product may malfunction if subjected to strong shocks or vibration.

Keep dry: This product is not waterproof, and may malfunction if immersed in water or exposed to high levels of humidity. Rusting of the internal mechanism can cause irreparable damage.

Avoid sudden changes in temperature: Sudden changes in temperature, such as those that occur when entering or leaving a heated building on a cold day, can cause condensation inside the device. To prevent condensation, place the device in a carrying case or plastic bag before exposing it to sudden changes in temperature.

Keep away from strong magnetic fields: Do not use or store this device in the vicinity of equipment that generates strong electromagnetic radiation or magnetic fields. Strong static charges or the magnetic fields produced by equipment such as radio transmitters could interfere with the display, damage data stored on the memory card, or affect the product's internal circuitry.

Keep the lens mount covered: Be sure to attach the body cap if the camera is without a lens.

Do not touch the dust shield: The dust shield covering the image sensor is easily damaged. Under no circumstances should you exert pressure on the shield or poke it with cleaning tools. These actions could scratch or otherwise damage the shield.

Turn the product off before removing or disconnecting the power source: Do not unplug the product or remove the battery while the product is on or while images are being recorded or deleted. Forcibly cutting power in these circumstances could result in loss of data or in damage to product memory or internal circuitry. To prevent an accidental interruption of power, avoid carrying the product from one location to another while the AC adapter is connected.



Cleaning: When cleaning the camera body, use a blower to gently remove dust and lint, then wipe gently with a soft, dry cloth. After using the camera at the beach or seaside, wipe off any sand or salt using a cloth lightly dampened in pure water and then dry the camera thoroughly.

Lenses are easily damaged. Dust and lint should be gently removed with a blower. When using an aerosol blower, keep the can vertical to prevent discharge of liquid. To remove fingerprints and other stains from the lens, apply a small amount of lens cleaner to a clean, soft cloth and wipe the lens carefully.

Storage: To prevent mold or mildew, store the camera in a cool, dry, well-ventilated area. If you are using an AC adapter, unplug the adapter to prevent fire. If the product will not be used for an extended period, remove the battery to prevent leakage and store the camera in a plastic bag containing a desiccant. Do not, however, store the camera case in a plastic bag, as this may cause the material to deteriorate. Note that desiccant gradually loses its capacity to absorb moisture and should be replaced at regular intervals.

To prevent mold or mildew, take the camera out of storage at least once a month. Turn the camera on and release the shutter a few times before putting it away.

Store the battery in a cool, dry place. Replace the terminal cover before putting the battery away.

Notes on the monitor: The monitor is constructed with extremely high precision; at least 99.99% of pixels are effective, with no more than 0.01% being missing or defective. Hence while these displays may contain pixels that are always lit (white, red, blue, or green) or always off (black), this is not a malfunction and has no effect on images recorded with the device.

Images in the monitor may be difficult to see in a bright light.



Do not apply pressure to the display, as this could cause damage or malfunction. Dust or lint on the display can be removed with a blower. Stains can be removed by wiping lightly with a soft cloth or chamois leather. Should the monitor break, care should be taken to avoid injury from broken glass and to prevent liquid crystal from the display touching the skin or entering the eyes and mouth.

Do not leave the lens pointed at the sun: Do not leave the lens pointed at the sun or other strong light source for an extended period. Intense light may cause the image sensor to deteriorate or produce a white blur effect in photographs.

Moiré: Moiré is an interference pattern created by the interaction of an image containing a regular, repeating grid, such as the pattern of weave in cloth or windows in a building, with the camera image sensor grid. In some cases, it may appear in the form of lines. If you notice moiré in your photographs, try changing the distance to the subject, zooming in and out, or changing the angle between the subject and the camera.

Lines: Noise in the form of lines may in rare cases appear in pictures of extremely bright or backlit subjects.

Batteries: Batteries may leak or explode if improperly handled. Observe the following precautions when handling batteries:

- Use only batteries approved for use in this equipment.
- Do not expose the battery to flame or excessive heat.
- Keep the battery terminals clean.
- Turn the product off before replacing the battery.
- Remove the battery from the camera or charger when not in use and replace the terminal cover. These devices draw minute amounts of charge even when off and could draw the battery down to the point that it will no longer function. If the battery will not be used for some time, insert it in the camera and run it flat before removing it and storing it in a location with an ambient temperature of 15 °C to 25 °C (59 °F to 77 °F; avoid hot or extremely cold locations). Repeat this process at least once every six months.
- Turning the camera on and off repeatedly when the battery is fully discharged will shorten battery life. Batteries that have been fully discharged must be charged before use.
- The internal temperature of the battery may rise while the battery is in use. Attempting to charge the battery while the internal temperature is elevated will impair battery performance, and the battery may not charge or charge only partially. Wait for the battery to cool before charging.
- Continuing to charge the battery after it is fully charged can impair battery performance.



- A marked drop in the time a fully charged battery retains its charge when used at room temperature indicates that it requires replacement. Purchase a new EN-EL22 battery.
- Charge the battery before use. When taking photographs on important occasions, ready a spare EN-EL22 battery and keep it fully charged. Depending on your location, it may be difficult to purchase replacement batteries on short notice. Note that on cold days, the capacity of batteries tends to decrease. Be sure the battery is fully charged before taking photographs outside in cold weather. Keep a spare battery in a warm place and exchange the two as necessary. Once warmed, a cold battery may recover some of its charge.
- Used batteries are a valuable resource; recycle in accord with local regulations.

Servicing the Camera and Accessories

The camera is a precision device and requires regular servicing. Nikon recommends that the camera be inspected by the original retailer or Nikon-authorized service representative once every one to two years, and that it be serviced once every three to five years (note that fees apply to these services). Frequent inspection and servicing are particularly recommended if the camera is used professionally. Any accessories regularly used with the camera, such as lenses, should be included when the camera is inspected or serviced.



Available Settings

The following table lists the settings that can be adjusted in each mode.

📷 Auto, 📷 Best Moment Capture, 🎬+ Advanced Movie, and 📺 Motion Snapshot Modes

	📷	📷		🎬+				📺					
		📷	📷	SCENE	P, S, A	M	SCENE	P, S, A	M				
Shooting, movie, and image processing menus	Image quality	✓ ¹	✓	✓	—	—	—	—	—	—	—	—	—
	Image size ²	✓ ¹	✓	✓	—	—	—	—	—	—	—	—	—
	Metering	—	✓ ³	—	—	✓ ⁴	✓ ⁴	—	✓	✓	—	—	—
	Auto distortion control	✓ ¹	✓	✓	—	—	—	—	—	—	—	—	—
	Active D-Lighting	—	✓ ³	—	—	—	—	—	—	—	—	—	—
	Long exposure NR	✓ ⁵	—	—	—	—	—	—	—	—	—	—	—
	Focus mode	—	✓ ³	—	—	✓	✓	—	—	—	—	—	—
	AF-area mode	—	✓ ³	—	—	✓ ⁴	✓ ⁴	—	✓	✓	—	—	—
	Face-priority	—	✓ ³	—	—	✓ ⁴	✓ ⁴	—	✓	✓	—	—	—
	Flash compensation	—	—	—	—	—	—	—	—	—	—	—	—
	Underwater flash	✓ ⁵	—	—	—	—	—	—	—	—	—	—	—
	White balance	—	✓ ³	—	—	✓	✓	—	✓	✓	—	—	—
	ISO sensitivity	—	✓ ³	—	—	✓	✓	—	✓	✓	—	—	—
	Picture Control	—	✓ ³	—	—	✓	✓	—	✓	✓	—	—	—
	Custom Picture Control	—	✓ ³	—	—	✓	✓	—	✓	✓	—	—	—
High ISO noise reduction	✓	✓	✓	✓	✓	✓	✓	✓	✓	✓	✓	✓	
Other settings	Continuous ⁶	✓	—	—	—	—	—	—	—	—	—	—	—
	Self-timer ⁶	✓	—	—	✓	✓	✓	—	—	—	—	—	—
	Exposure compensation	✓	✓ ⁷	—	✓	✓	—	✓	✓	—	—	—	—
	Flash mode	✓ ⁵	—	—	—	—	—	—	—	—	—	—	—

1 Has no effect on movies recorded with movie-record button.

2 RAW images fixed at 4592 × 3072 pixels.

3 Available when **P, S, A,** or **M** is selected for **Exposure mode**.

4 Not available when 🎬 **Slow motion** is selected in advanced movie mode (□ 48).







5 Not available when 10, 20, 30, or 60 fps is selected in continuous mode (□ 69).

6 Continuous and self-timer can not be used together.

7 Available when SCENE, **P, S,** or **A** is selected for **Exposure mode**.



Creative Mode

In the table below, creative modes are represented by the following icons:  creative palette,  HDR,  soft,  miniature effect,  selective color,  cross process, and  toy camera effect.

		P, S, A	M			 ,  ,  ,  , 
Shooting, movie, and image processing menus	Image quality	✓ ¹	✓ ¹	✓ ^{1,2}	✓ ^{1,2}	✓ ^{1,2}
	Image size	✓ ^{1,3}	✓ ^{1,3}	✓ ¹	✓ ¹	✓ ¹
	Metering	✓ ¹	✓ ¹	—	—	—
	Auto distortion control	✓ ¹	✓ ¹	✓ ¹	✓ ¹	✓ ¹
	Active D-Lighting	✓ ¹	✓ ¹	—	—	—
	Long exposure NR	✓ ⁴	✓ ⁴	—	—	—
	Focus mode	✓ ¹	✓ ¹	—	—	—
	AF-area mode	✓ ¹	✓ ¹	—	—	—
	Face-priority	✓	✓	—	—	—
	Flash compensation	✓ ^{4,5}	✓ ^{4,5}	—	—	✓ ⁵
	Underwater flash	✓ ^{4,5}	✓ ^{4,5}	—	—	✓ ⁵
	White balance	✓	✓	—	—	—
	ISO sensitivity	✓ ¹	✓ ¹	—	—	—
	Picture Control	✓	✓	—	—	—
	Custom Picture Control	✓	✓	—	—	—
High ISO noise reduction	✓	✓	—	—	—	
Other settings	Continuous ⁶	✓	✓	—	—	—
	Self-timer ⁶	✓	✓	✓	✓	✓
	Exposure compensation	✓	—	—	✓	✓
	Flash mode	✓ ⁴	✓ ⁴	—	—	✓

1 Has no effect on movies recorded with movie-record button.

2 **NEF (RAW)** not available.

3 RAW images fixed at 4592 × 3072 pixels.

4 Not available when 10, 20, 30, or 60 fps is selected in continuous mode (□ 69).

5 Not available at an ISO sensitivity of **12800 (NR)**.

6 Continuous and self-timer can not be used together.



Defaults

Defaults for the options in the playback, shooting, movie, image processing, and setup menus may be found on pages 110, 121, 143, 148, and 162, respectively. Defaults for other settings are listed below.

Option	Default
Focus area (☐ 138)	Center*
Flexible program (☐ 35)	Off
Focus lock (☐ 139)	Off
Continuous/self-timer (☐ 69, 71)	 (single frame)
Exposure compensation (☐ 73)	0.0
Flash mode (☐ 75, 77)	Auto, Soft, Miniature effect, Selective color, Cross process, Toy camera effect: Auto P Programmed auto, S Shutter-priority auto, A Aperture-priority auto, M Manual: Fill flash
Picture Control settings (☐ 155)	Unmodified

* Not displayed when **Auto-area** is selected for **AF-area mode**.



Memory Card Capacity

The following table shows the number of pictures or amount of movie footage that can be stored on a 16GB SanDisk SDSDQXP-016G-J35 UHS-I microSDHC card at different image quality, size, or movie settings. All figures are approximate; file size varies with the type of card and scene recorded.

■ Auto, Creative, Active Selection, and Smart Photo Selector*

Image quality (□ 125)	Image size (□ 125)	File size	No. of images
NEF (RAW)	—	18.9 MB	803
JPEG fine	4592 × 3072	8.7 MB	1700
	3440 × 2296	5.1 MB	2900
	2288 × 1528	2.6 MB	5800
JPEG normal	4592 × 3072	4.6 MB	3200
	3440 × 2296	2.8 MB	5300
	2288 × 1528	1.6 MB	9500

* **Number of shots saved** set to 1.

■ Smart Photo Selector*

Image quality (□ 125)	Image size (□ 125)	File size	No. of shots
NEF (RAW)	—	94.4 MB	160
JPEG fine	4592 × 3072	43.3 MB	350
	3440 × 2296	25.5 MB	592
	2288 × 1528	12.9 MB	1100
JPEG normal	4592 × 3072	23.1 MB	656
	3440 × 2296	14.2 MB	1000
	2288 × 1528	7.9 MB	1900

* **Number of shots saved** set to 5. File size is total for 5 images.



■■ HD, Fast-Motion, Jump-Cut, and 4-Second Movies

Frame size/frame rate (□ 146) ¹	Maximum total length (approx.) ²
1080/60p	47 minutes
1080/30p	1 hour 20 minutes
720/60p	1 hour 57 minutes
720/30p	2 hours 32 minutes

1 HD movies only. Fast-motion, jump-cut, and 4-second movies are recorded at 1080/30p.

2 For information on the maximum length that can be recorded in a single clip, see page 146.

■■ Slow-Motion Movies

Frame rate (□ 145)	Maximum total recorded length (approx.)*
400 fps	1 hour
1200 fps	43 minutes

* Up to 2 s of slow-motion footage can be recorded in a single clip. Playback length is about 13 (**400 fps**) or 40 (**1200 fps**) times the recorded length.

■■ Motion Snapshots

Image quality	Image size	Format (□ 129)	File size	No. of shots
—	—	NMS	15.9 MB *	954
—	—	MOV	18.1 MB	836

* File size is the total for a single photograph and movie.



Troubleshooting

If the camera fails to function as expected, check this list of common problems before consulting your retailer or Nikon representative.

Battery/Display

The camera is on but does not respond: Wait for recording or any other processing to end. If the problem persists, turn the camera off. If the camera still does not respond, remove and replace the battery or disconnect and reconnect the AC adapter, but note that this will delete any data not yet saved. Data already saved to the memory card are unaffected.

The display is off:

- The camera is off (☞ 17) or the battery is exhausted (☞ 10, 21).
 - The display has turned off automatically to save power (☞ 166). The display can be reactivated by pressing the shutter-release button.
 - The camera is connected to a computer (☞ 100) or television (☞ 103).
-

The camera turns off without warning:

- The battery is low (☞ 10, 21).
 - The display has turned off automatically to save power (☞ 166). The display can be reactivated by pressing the shutter-release button.
 - The camera's internal temperature is high (☞ xvi, 192). Wait for the camera to cool before turning it on again.
-

Indicators are not displayed: Use the **Display > Shooting** and **Display > Playback** options in the setup menu to choose the information displayed (☞ 165).



Shooting (All Modes)

The camera takes time to turn on: Delete files or format the memory card.

The shutter-release is disabled:

- The battery is exhausted (☐ 10, 21).
 - The memory card is full (☐ 21).
 - The flash is charging (☐ 78).
 - The camera is not in focus (☐ 23).
 - You are currently filming a slow-motion movie (☐ 50).
-

Only one picture is taken each time the shutter-release button is pressed in continuous release mode:  is selected in continuous mode (☐ 69) and the built-in flash is raised.

The camera does not focus automatically:

- The subject is not suited to autofocus (☐ 135).
 - The camera is in manual focus mode (☐ 134, 136).
-

Focus does not lock when the shutter-release button is pressed halfway: Set the focus mode to **AF-S** (☐ 134, 139).

Focus area selection is unavailable: Focus area selection is not available in auto-area AF (☐ 138) or face priority (☐ 28). In other AF-area modes, the focus area can be selected by pressing .

AF-area mode selection is unavailable: The camera is in auto or best moment capture mode (☐ 54), an option other than **P, S, A, M** is selected in creative mode (☐ 33), manual focus mode is selected (☐ 134), or the  **Scene auto selector** is used (☐ 124).

Image size selection is unavailable: **NEF (RAW)** is selected for image quality (☐ 125).

The camera is slow to record photos: Turn long exposure noise reduction off (☐ 133) and choose an option for ISO sensitivity (☐ 154) other than **12800 (NR)**. In creative mode, additional time may be needed to record photos when **HDR** is selected (☐ 42).

Noise (bright spots, randomly-spaced bright pixels, fog, or lines) appears in photos:

- Lower ISO sensitivity or enable high ISO noise reduction (☐ 154).
 - Use long exposure noise reduction at shutter speeds slower than 1 s (☐ 133).
-

Smudges appear in photographs: Clean the front and rear lens elements or the dust shield (☐ 176).



Flicker or banding appears in movies or in the display: Choose a **Flicker reduction** setting that matches the local AC power supply (☞ 167).

No flash: See page 79. The flash will not fire when off (☞ 75, 77); in **P**, **S**, **A**, and **M** modes, the flash will not fire when lowered.

Menu items are unavailable: Some options are only available in particular shooting or exposure modes (☞ 181) or when wireless mobile adapter is attached (☞ 80).

Shooting (P, S, A, and M Modes)

The shutter release is disabled: You selected mode **S** after choosing a shutter speed of “Bulb” in mode **M** (☞ 36). Choose a different shutter speed.

Some shutter speeds are not available: You are using the flash.

Colors are unnatural:

- Adjust white balance to match the light source (☞ 149).
- Adjust Picture Control settings (☞ 155).

Cannot measure white balance: The subject is too dark or too bright (☞ 152).

Picture Controls produce varying results: **A** (auto) is selected for sharpening, contrast, or saturation. For consistent results over a series of photos, choose another setting (☞ 157).

Noise (reddish areas and other artifacts) appears in long time-exposures: Enable long exposure noise reduction (☞ 133).

Movies

Cannot record movies: The movie-record button can not be used to record movies in best moment capture or Motion Snapshot mode (☞ 57, 67).

No sound is recorded for movies:

- **Microphone off** is selected for **Movie sound options > Microphone** (☞ 147).
- Live audio is not recorded with slow-motion, fast-motion, or jump-cut movies (☞ 48) or with Motion Snapshots recorded with **None** selected for **Audio** (☞ 67).



Playback

“Tall” (portrait) orientation photos are displayed in “wide” (landscape) orientation:

- Select **On** for **Rotate tall** (☐ 113).
 - The photos were taken with **Auto image rotation** off (☐ 169).
 - Camera was pointed up or down when the photo was taken (☐ 169).
 - Photo is displayed in image review (☐ 113).
-

Cannot hear movie sound:

- Rotate the multi selector clockwise to raise the volume (☐ 51). If the camera is connected to a television (☐ 103), use the controls for the TV to adjust the volume.
 - Live audio is not recorded with slow-motion, fast-motion, or jump-cut movies (☐ 48) or with Motion Snapshots recorded with **None** selected for **Audio** (☐ 67).
-

Cannot delete images: Remove protection from the files before deletion (☐ 113).

Cannot select photos for printing: The memory card is full (☐ 21) or the photos are in NEF (RAW) format. To print NEF (RAW) photos, transfer the pictures to a computer and use the supplied software or Capture NX 2 (☐ 100).

Pictures are not displayed on TV: The camera is not correctly connected (☐ 103).

Pictures cannot be transferred to a computer: If your system does not meet the requirements on page 98, you may still be able to transfer pictures to the computer using a card reader.

Photos are not displayed in Capture NX 2: Update to the latest version (☐ 172).

Miscellaneous

The date of recording is not correct: Set the camera clock (☐ 19, 168).

Menu items are unavailable: Some options are only available at particular settings (☐ 181) or when a memory card is inserted (☐ 12).



Error Messages

This section lists the error messages that appear in the display.

Message	Solution	
(Shutter-speed or aperture display flashes)	If the subject is too bright, lower ISO sensitivity or choose a faster shutter speed or smaller aperture (higher f-number).	36, 37, 38, 154
	If the subject is too dark, raise ISO sensitivity, use the flash, or choose a slower shutter speed or larger aperture (lower f-number).	36, 37, 38, 74, 154
Keeping the zoom ring button pressed, rotate the zoom ring to extend the lens.	A lens with a retractable lens barrel button is attached with the lens barrel retracted. Keeping the retractable lens barrel button pressed, rotate the zoom ring to extend the lens.	16, 200
Check lens. Pictures can only be taken when a lens is attached.	Attach a lens.	15
Cannot take pictures. Insert fully-charged battery.	Turn the camera off and recharge the battery or insert a fully charged spare battery.	10, 12
Start-up error. Turn the camera off and then on again.	Turn the camera off, remove and replace the battery, and then turn the camera on.	12, 17
The clock has been reset.	Set the camera clock.	19, 168
No memory card.	Turn the camera off and confirm that the card is correctly inserted.	12



Message	Solution	
This memory card cannot be used. Card may be damaged; insert a different card.	<ul style="list-style-type: none"> • Use an approved card. • Format the card. If the problem persists, the card may be damaged. Contact a Nikon-authorized service representative. • Insert a new memory card. 	173 164 12, 173
This memory card is not formatted. Format the memory card?	Select Yes to format the card, or turn the camera off and insert another memory card.	12, 164
Memory card is full.	<ul style="list-style-type: none"> • You may be able to record additional images if you reduce image quality or size. • Delete unwanted images. • Insert another memory card. 	125 91 12, 173
Cannot create additional folders on memory card.	If the current folder is numbered 999 and contains either 999 photographs or a photograph numbered 9999, the shutter-release button will be disabled and no further photographs can be taken. Choose Yes for Reset file numbering and then either format the current memory card or insert a new memory card.	167
The movie-record button cannot be used in this mode.	The movie-record button can not be used in best moment capture or Motion Snapshot modes.	57, 67
Photographs cannot be recorded in this mode.	The shutter-release button can not be used to take photographs while a slow-motion movie is being recorded.	50
Photographs cannot be taken in shutter-priority auto mode at a shutter speed of "Bulb".	Choose a different shutter speed, or select mode M .	36, 38



Message	Solution	
Failed to update lens firmware. Try again after turning the camera off and on.	Turn the camera off and then on again and reattempt the update. If the problem persists or reoccurs frequently, contact a Nikon-authorized service representative.	—
An error has occurred in the internal circuitry. Try again after turning the camera off and on.	Turn the camera off and then on again. If the problem persists or reoccurs frequently, contact a Nikon-authorized service representative.	—
The camera's internal temperature is high. The camera will now turn off.	Wait for the camera to cool.	xvi
Memory card contains no images.	To view pictures, insert a memory card containing images.	12
Cannot display this file.	The file has been created or modified on a computer or different make of camera, or is corrupt.	—
Check printer.	Check the printer.	—*
Check paper.	Select Resume after loading paper of the correct size.	—*
Paper jam.	Clear the jam and select Resume .	—*
Out of paper.	Insert paper and select Resume .	—*
Check ink supply.	Select Resume after checking the ink.	—*
Out of ink.	Replace the ink and select Resume .	—*

* See the printer manual for more information.



Specifications

Nikon 1 S2 Digital Camera

Type		
Type	Digital camera with support for interchangeable lenses	
Lens mount	Nikon 1 mount	
Effective angle of view	Approx. 2.7× lens focal length (35 mm format equivalent)	
Effective pixels		
Effective pixels	14.2 million	
Image sensor		
Image sensor	13.1 mm × 8.8 mm CMOS sensor (Nikon CX format)	
Storage		
Image size (pixels)	Still images taken in auto, creative, and best moment capture modes (aspect ratio 3 : 2)	
	• 4592 × 3072	• 3440 × 2296
	• 2288 × 1528	
	Still images taken during movie recording (aspect ratio 3 : 2)	
	• 4592 × 3072 (1080/60p, 1080/30p)	
	• 1280 × 856 (720/60p, 720/30p)	
	Motion Snapshots (photo portion, aspect ratio 16 : 9)	
	4592 × 2576	
File format	• NEF (RAW): 12-bit, compressed • JPEG: JPEG-Baseline compliant with fine (approx. 1 : 4), normal (approx. 1 : 8) compression	
Picture Control system	Standard, Neutral, Vivid, Monochrome, Portrait, Landscape; selected Picture Control can be modified; storage for custom Picture Controls	
Media	microSD (micro Secure Digital), microSDHC, and microSDXC memory cards	
File system	DCF 2.0, DPOF, Exif 2.3, PictBridge	



Shooting modes	auto; creative, with a choice of the following options: P , S , A , M , creative palette, HDR, soft, miniature effect, selective color, cross process, and toy camera effect; best moment capture (Active Selection and Smart Photo Selector); advanced movie (HD movie, slow motion, jump cut, fast motion and 4-second movie), Motion Snapshot
Shutter	
Type	Electronic shutter
Speed	1/16,000–30 s in steps of 1/3 EV; Bulb Note: Bulb ends automatically after approximately 2 minutes
Flash sync speed	Synchronizes with shutter at X=1/60 s or slower
Release	
Mode	<ul style="list-style-type: none"> • Single frame, continuous • Self-timer
Frame advance rate	Approx. 5, 10, 20, 30, or 60 fps
Self-timer	2 s, 10 s
Exposure	
Metering	TTL metering using image sensor
Metering method	<ul style="list-style-type: none"> • Matrix • Center-weighted: Meters 4.5 mm circle in center of frame • Spot: Meters 2 mm circle centered on selected focus area
Mode	P programmed auto with flexible program; S shutter-priority auto; A aperture-priority auto; M manual; scene auto selector
Exposure compensation	-3–+3 EV in increments of 1/3 EV
Exposure lock	Luminosity locked at metered value when shutter-release button is pressed halfway
ISO sensitivity (Recommended Exposure Index)	ISO 200–12800 in steps of 1 EV; 12800 (NR); auto ISO sensitivity control (ISO 200–6400, 200–3200, 200–800) available (user controlled in P , S , A , and M modes)
Active D-Lighting	On, off



Focus	
Autofocus	Hybrid autofocus (phase-detection/contrast-detect AF); AF-assist illuminator
Lens servo	<ul style="list-style-type: none"> • Autofocus (AF): Single AF (AF-S); continuous AF (AF-C); auto AF-S/AF-C selection (AF-A); full-time AF (AF-F) • Manual focus (MF)
AF-area mode	Single-point, auto-area, subject tracking
Focus area	<ul style="list-style-type: none"> • Single-point AF: 135 focus areas; the center 73 areas support phase-detection AF • Auto-area AF: 41 focus areas
Focus lock	Focus can be locked by pressing shutter-release button halfway (single AF)
Face priority	On, off
Flash	
Built-in flash	<ul style="list-style-type: none"> • Auto; Soft, Miniature effect, Selective color, Cross process, Toy camera effect (Creative mode): Flash pops up automatically and fires as required • P programmed auto, S shutter-priority auto, A aperture-priority auto, M manual (Creative mode): Manual pop-up
Guide Number (GN)	Approx. 5/16 (m/ft, ISO 100, 20 °C/68 °F; at ISO 200, Guide Number is approx. 7/23)
Control	i-TTL flash control using image sensor
Mode	Auto, auto + red-eye reduction, fill flash, fill flash + slow sync, red-eye reduction, red-eye reduction + slow sync, rear-curtain sync, rear curtain + slow sync, off
Flash compensation	-3 +1 EV in increments of 1/3 EV
Flash-ready indicator	Lights when built-in flash unit is fully charged
White balance	Auto, incandescent, fluorescent, direct sunlight, flash, cloudy, shade, underwater, preset manual, all except preset manual with fine tuning



Movie	
Metering	TTL metering using image sensor
Metering method	<ul style="list-style-type: none"> • Matrix • Center-weighted: Meters 4.5 mm circle in center of frame • Spot: Meters 2 mm circle centered on selected focus area
Frame size (pixels)/ recording rate	HD movies (aspect ratio 16 : 9)
	<ul style="list-style-type: none"> • 1920 × 1080/60p (59.94 fps) • 1920 × 1080/30p (29.97 fps) • 1280 × 720/60p (59.94 fps) • 1280 × 720/30p (29.97 fps)
	Slow-motion movies (aspect ratio 8 : 3)
	<ul style="list-style-type: none"> • 640 × 240/400 fps (plays at 30p/29.97 fps) • 320 × 120/1200 fps (plays at 30p/29.97 fps)
	Fast-motion, jump-cut, and 4-second movies (aspect ratio 16 : 9)
	1920 × 1080/30p (29.97 fps)
	Motion Snapshots (movie portion, aspect ratio 16 : 9)
	1280 × 720/60p (59.94 fps) (plays at 24p/23.976 fps)
File format	MOV
Video compression	H.264/MPEG-4 Advanced Video Coding
Audio recording format	PCM
Audio recording device	Built-in stereo microphone; sensitivity adjustable
Monitor	7.5 cm (3-in.), approx. 460k-dot, TFT LCD with brightness adjustment
Playback	Full-frame and thumbnail (4, 9, or 16 images or calendar) playback with playback zoom, movie playback, slide show, histogram display, auto image rotation, and rating option
Interface	
USB	Hi-Speed USB
HDMI output	Type D HDMI connector



Supported languages	Arabic, Bengali, Bulgarian, Chinese (Simplified and Traditional), Czech, Danish, Dutch, English, Finnish, French, German, Greek, Hindi, Hungarian, Indonesian, Italian, Japanese, Korean, Marathi, Norwegian, Persian, Polish, Portuguese (European and Brazilian), Romanian, Russian, Serbian, Spanish, Swedish, Tamil, Telugu, Thai, Turkish, Ukrainian, Vietnamese
Power source	
Battery	One rechargeable Li-ion EN-EL22 battery
AC adapter	EH-5b AC adapter; requires EP-5E power connector (available separately)
Tripod socket	
	1/4-in. (ISO 1222)
Dimensions/weight	
Dimensions (W × H × D)	Approx. 101.0 × 60.8 × 29.4 mm (4.0 × 2.4 × 1.2 in.), excluding projections
Weight	Approx. 230 g (8.1 oz) with battery and memory card but without body cap; approx. 190 g (6.7 oz), camera body only
Operating environment	
Temperature	0 °C–40 °C (+32 °F–104 °F)
Humidity	85% or less (no condensation)

- Unless otherwise stated, all figures are for a camera with a fully-charged battery operating at the temperature specified by the Camera and Imaging Products Association (CIPA): 23 ±3 °C (73.4 ±5.4 °F).
- Nikon reserves the right to change the specifications of the hardware and software described in this manual at any time and without prior notice. Nikon will not be held liable for damages that may result from any mistakes that this manual may contain.



MH-29 battery charger	
Rated input	AC 100–240 V, 50–60 Hz, 0.2 A
Rated output	DC 8.4 V/0.6 A
Supported batteries	Nikon EN-EL22 rechargeable Li-ion batteries
Charging time	Approx. 3 hours at an ambient temperature of 25 °C (77 °F) when no charge remains
Operating temperature	0 °C–40 °C (+32 °F–104 °F)
Dimensions (W × H × D)	Approx. 67.0 × 28.0 × 94.0 mm (2.6 × 1.1 × 3.7 in.), excluding plug adapter
Weight	Approx. 83 g (2.9 oz), excluding plug adapter

EN-EL22 rechargeable Li-ion battery	
Type	Rechargeable lithium-ion battery
Rated capacity	7.2 V, 1010 mAh
Operating temperature	0 °C–40 °C (+32 °F–104 °F)
Dimensions (W × H × D)	Approx. 30.7 × 50.0 × 13.0 mm (1.2 × 2.0 × 0.5 in.)
Weight	Approx. 39 g (1.4 oz), excluding terminal cover

1 NIKKOR VR 10–30mm f/3.5–5.6 PD-ZOOM	
Type	1 mount lens
Focal length	10–30 mm
Maximum aperture	f/3.5–5.6
Construction	9 elements in 7 groups (including 4 aspherical lens elements, 1 ED lens element, and HRI lens elements)
Angle of view	77°–29° 40'
Vibration reduction	Lens shift using voice coil motors (VCMs)
Minimum focus distance	0.2 m (0.7 ft) from focal plane at all zoom positions
Diaphragm blades	7 (rounded diaphragm opening)
Diaphragm	Fully automatic
Aperture range	<ul style="list-style-type: none"> • 10 mm focal length: f/3.5–16 • 30 mm focal length: f/5.6–16
Dimensions	Approx. 58 mm diameter × 28 mm (distance from camera lens mount flange when lens is retracted)
Weight	Approx. 85 g (3.0 oz)



1 NIKKOR 11–27.5mm f/3.5–5.6	
Type	1 mount lens
Focal length	11–27.5 mm
Maximum aperture	f/3.5–5.6
Construction	8 elements in 6 groups (including 1 ED lens element and 1 aspherical lens element), 1 protective glass element
Angle of view	72°–32° 20'
Minimum focus distance	0.3 m (1.0 ft) from focal plane at all zoom positions
Diaphragm blades	7 (rounded diaphragm opening)
Diaphragm	Fully automatic
Aperture range	<ul style="list-style-type: none"> • 11 mm focal length: f/3.5–16 • 27.5 mm focal length: f/5.6–16
Filter-attachment size	40.5 mm (P=0.5 mm)
Dimensions	Approx. 57.5 mm diameter × 31 mm (distance from camera lens mount flange when lens is retracted)
Weight	Approx. 83 g (3.0 oz)

Specifications subject to change without notice. Nikon will not be held liable for damages that may result from any mistakes that this manual may contain.



■ 1 NIKKOR Lenses
1 NIKKOR VR 10–30mm f/3.5–5.6 PD-ZOOM

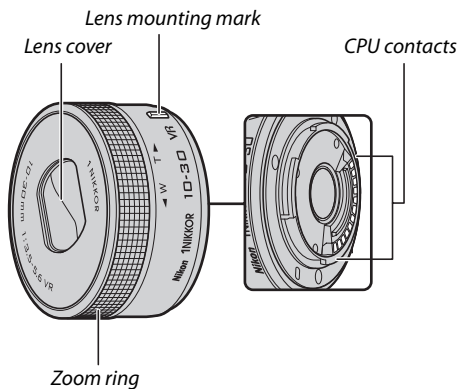

1 NIKKOR 11–27.5mm f/3.5–5.6

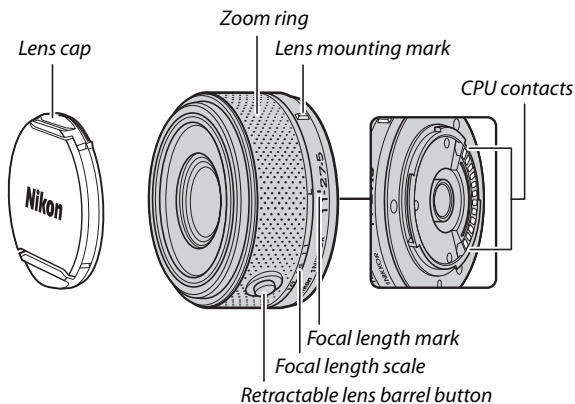

1 NIKKOR lenses are exclusively for Nikon 1 interchangeable lens format digital cameras. The angle of view is equivalent to a 35 mm format lens with a focal length about 2.7× longer. The 1 NIKKOR VR 10–30mm f/3.5–5.6 PD-ZOOM supports vibration reduction and can be used with vibration reduction **On** or **Off** selected for **Optical VR** in the camera menu (📖 133).

Use the zoom ring to zoom in and out (📖 28).

Lens Care

- Keep the CPU contacts clean.
- Use a blower to remove dust and lint from the lens surfaces. To remove smudges and fingerprints, apply a small amount of ethanol or lens cleaner to a soft, clean cotton cloth or lens-cleaning tissue and clean from the center outwards using a circular motion, taking care not to leave smears or touch the glass with your fingers.
- Never use organic solvents such as paint thinner or benzene to clean the lens.
- A lens hood or NC filter can be used to protect the front lens element. When using an optional lens hood, do not pick up or hold the lens or camera using only the hood. Lens hoods and filters are not available for the 1 NIKKOR VR 10–30mm f/3.5–5.6 PD-ZOOM.
- When the lens is not in use, attach the rear cap and either ensure that the lens is retracted and the cover closed (1 NIKKOR VR 10–30mm f/3.5–5.6 PD-ZOOM) or attach the front cap (other lenses).
- If the lens will not be used for an extended period, store it in a cool, dry location to prevent mold and rust. Do not store in direct sunlight or with naphtha or camphor moth balls.
- Keep the lens dry. Rusting of the internal mechanism can cause irreparable damage.
- Leaving the lens in extremely hot locations could damage or warp parts made from reinforced plastic.
- When using the 1 NIKKOR VR 10–30mm f/3.5–5.6 PD-ZOOM, be sure not touch the lens cover. Failure to observe this precaution could result in product malfunction.



Supplied Accessories

- 40.5 mm snap-on Front Lens Cap LC-N40.5 (for use with the 1 NIKKOR 11–27.5mm f/3.5–5.6)
- Rear Lens Cap LF-N1000

Optional Accessories

- 40.5 mm screw-on filters (for use with the 1 NIKKOR 11–27.5mm f/3.5–5.6)
- 40.5 mm screw-on Hood HN-N102 (for use with the 1 NIKKOR 11–27.5mm f/3.5–5.6; attaches as shown below)

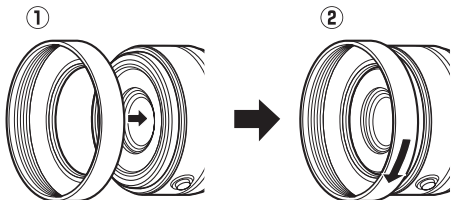

■ The Optional FT1 Mount Adapter

Read this section for information on using the optional FT1 mount adapter. Before proceeding, be sure that you have read and understood this manual and the documentation for the FT1 and lenses.

Autofocus

Autofocus is available only with AF-S lenses; other lenses support manual focus only. Set the camera focus mode to **AF-S** or **AF-C**. The only AF-area mode available is **Single-point** and the camera focuses on the subject in the center focus area only. Face priority is not supported. In some cases, a beep may sound, the in-focus indicator may be displayed, and pictures can be taken when the camera is not in focus; if this occurs, focus manually.

Manual Focus

Follow the steps below to focus manually when using the FT1 with a NIKKOR F mount lens.

1 Select manual focus mode.

In the shooting menu, select **Focus mode**, highlight **Manual focus**, press **▶**, and choose the magnification for the manual focus display from 10×, 5×, 2×, and 1× (zoom off) (□ 136).

2 Focus.

Rotate the lens focus ring until the subject is in focus.

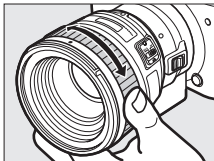

If **AF-S** or **AF-C** is selected for **Focus mode** and the lens supports autofocus with manual override, you can focus using autofocus and then keep the shutter-release button pressed halfway and rotate the lens focus ring to fine-tune focus manually. To refocus using autofocus, press the shutter-release button halfway again.

To zoom in on the display for more precise focus, press **OK** (note that this feature is not available during movie recording or in slow-motion movie mode). The display will be zoomed in to the magnification selected in Step 1 and a navigation window will appear in a gray frame at the bottom right of the display.



Navigation window

Use the multi selector to scroll to areas of the frame not visible in the display. Press **OK** to exit zoom.



The Electronic Rangefinder

If a CPU lens is attached in manual focus mode, the focus indicator can be used to check whether the camera is focused on the subject in the center focus area.

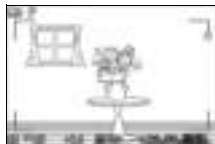

Focus indicator	Status
●	In focus.
▶	Camera focused in front of subject.
◀	Camera focused behind subject.
▶ ◀ (flashes)	Unable to determine focus.

Note that with some subjects, the in-focus indicator (●) may be displayed when the camera is not in focus. Check focus in the display before shooting.

Error Messages and Displays

The following warnings appear in the camera aperture display.

Display	Problem	Solution
FEE	Lens aperture ring is not locked at minimum aperture.	When using CPU lenses, lock aperture ring at minimum aperture (highest f-number).
F---	Non-CPU lens is attached, or no lens is attached.	When using non-CPU lens, rotate lens aperture ring to adjust aperture.

Restrictions

- Auto and best moment capture modes are not supported.
- Motion Snapshots can be recorded only when an AF-S lens is attached and the camera is in autofocus mode and then only when the subject is in focus. Do not attempt to adjust focus using the focus ring.
- Shutter speeds of 1 s or slower are not available.
- The sound monitor switch and focus operation button (Focus Lock/MEMORY RECALL/AF Start) have no effect.



Precautions for Use

- Lenses over 380 g (13.4 oz) should be supported at all times. Do not hold the camera or carry the camera by the strap without supporting the lens. Failure to observe this precaution could damage the camera lens mount.
- Lines may appear in photographs taken with non-CPU lenses stopped down to minimum aperture.
- In advanced movie mode, select exposure mode **A** or **M** to prevent sounds made by the lens being picked up by the microphone.
- During continuous shooting, focus is fixed at the position for the first shot in each burst. Frame rates may slow when  is selected in continuous mode.
- Certain lenses will block the AF-assist illuminator and, at some distances, the flash.
- The tops and bottoms may be missing from circular *bokeh* shapes created at wide apertures using lenses with a maximum aperture of f/1.4.



■ Supported Standards

- **DCF Version 2.0:** The Design Rule for Camera File Systems (DCF) is a standard widely used in the digital camera industry to ensure compatibility among different makes of camera.
- **DPOF:** Digital Print Order Format (DPOF) is an industry-wide standard that allows pictures to be printed from print orders stored on the memory card.
- **Exif version 2.3:** The camera supports Exif (Exchangeable Image File Format for Digital Still Cameras) version 2.3, a standard in which information stored with photographs is used for optimal color reproduction when the images are output on Exif-compliant printers.
- **PictBridge:** A standard developed through cooperation with the digital camera and printer industries, allowing photographs to be output directly to a printer without first transferring them to a computer.
- **HDMI:** High-Definition Multimedia Interface is a standard for multimedia interfaces used in consumer electronics and AV devices capable of transmitting audiovisual data and control signals to HDMI-compliant devices via a single cable connection.



Trademark Information

Mac and OS X are registered trademarks of Apple Inc. in the United States and/or other countries. Microsoft, Windows, and Windows Vista are either registered trademarks, or trademarks of Microsoft Corporation in the United States and/or other countries. The PictBridge logo is a trademark. The microSD, microSDHC, and microSDXC logos are trademarks of SD-3C, LLC. HDMI, the HDMI logo and High-Definition Multimedia Interface are trademarks or registered trademarks of HDMI Licensing LLC.

HDMI

All other trade names mentioned in this manual or the other documentation provided with your Nikon product are trademarks or registered trademarks of their respective holders.

FreeType License (FreeType2)

Portions of this software are copyright © 2012 The FreeType Project (<http://www.freetype.org>). All rights reserved.

MIT License (HarfBuzz)

Portions of this software are copyright © 2014 The HarfBuzz Project (<http://www.freedesktop.org/wiki/Software/HarfBuzz>). All rights reserved.



Battery Life

The number of shots or movie footage that can be recorded with fully-charged batteries varies with the condition of the battery, temperature, the interval between shots, and the length of time menus are displayed. Sample figures for EN-EL22 (1010 mAh) batteries are given below.

- **Still images: Approximately 270 shots**
- **Movies: Approximately 65 minutes at 1080/30p**

Measured according to CIPA standards at 23 ± 3 °C (73.4 ± 5.4 °F) with the camera at default settings, a fully-charged battery, a 1 NIKKOR VR 10–30mm f/3.5–5.6 PD-ZOOM lens, and a 16GB SanDisk SDSDQXP-016G-J35 UHS-I microSDHC card. Value for still images obtained under the following test conditions: photographs taken at intervals of 30 s with the built-in flash fired with every other shot and the camera turned off and then on after every ten shots. Value for movies obtained under the following test conditions: a series of 20 minute movies with a file size of up to 4 GB were recorded; recording was only interrupted when temperature warning was displayed.

The following can reduce battery life:

- Keeping the shutter-release button pressed halfway
- Repeated autofocus operations
- Taking NEF (RAW) photographs
- Slow shutter speeds
- Using a wireless mobile adapter
- Using vibration reduction mode with VR lenses
- Using zoom with power zoom lenses





























To ensure that you get the most from rechargeable Nikon EN-EL22 batteries:









- Keep the battery contacts clean. Soiled contacts can reduce battery performance.
- Use batteries immediately after charging. Batteries will lose their charge if left unused.



Index

Symbols

 (Auto mode)	7, 22
 (Creative mode)	7, 32
 (Best moment capture mode) .	7, 54
 (Advanced movie mode)	7, 45, 48
 (Motion Snapshot mode)	7, 64
 (Scene auto selector)	124
P (Programmed auto)	33, 35, 124
S (Shutter-priority auto) ..	33, 36, 124
A (Aperture-priority auto)	33, 37, 124
M (Manual)	33, 38, 124
 (Creative palette)	33, 41
 (HDR)	33, 42
 (Soft)	33
 (Miniature effect)	33
 (Selective color)	33, 43
 (Cross process)	33, 44
 (Toy camera effect)	33, 130
 (Portrait)	27
 (Landscape)	27
 (Night portrait)	27
 (Close up)	27
 (Night landscape)	27
 (Auto)	27
 (flexible program)	35
MENU (menu) button	6, 110, 121, 143, 148, 162
 (playback) button	25, 62, 68
 (delete) button ..	26, 52, 63, 68, 91
 (OK) button	5
 (feature)	9
 (continuous shooting/self-timer) .	69, 71
 (exposure compensation)	73
 (flash mode)	75, 77
PRE (Preset manual)	151
 (matrix)	130

 (centerweighted)	130
 (spot)	130
 (auto-area)	138
 (single-point)	138
 (subject tracking)	138
 (Single frame)	70
 (red-eye reduction)	75, 77
SLOW (slow sync)	77
REAR (rear-curtain sync)	77
 (flash-ready indicator)	78

Numerics

4-second movie	48
----------------------	----

A

AC adapter	171, 174
Accessories	171
Active D-Lighting	132
Active selection	54, 127
Advanced movie mode	7, 45, 48
AE lock	166
AF	134, 138
AF-A	134
AF-area mode	138
AF-assist illuminator	140
AF-C	134
AF-F	134
AF-S	134
Aperture	37, 38
Aperture-priority auto	33, 37, 124
Attaching the lens	15
Audio	67
Auto distortion control	131
Auto image capture	147
Auto image rotation	169
Auto mode	22
Auto photography	147
Auto power off	17, 166
Auto-area (AF-area mode)	138
Autofocus	134, 138
Automatic scene selection	27

Auto-select AF	134
Available settings	181

B

Basic info	85, 165
Battery	10, 12, 21, 198
Beep	23, 72, 166
Best moment capture mode	54
Best shot	58, 62
Body cap	2, 172
Border (PictBridge)	106
Brightness	157
Buffering	56, 59, 65
Built-in AF assist	140
Built-in flash	74
Bulb	39

C

Calendar	89, 93
Calendar playback	89
Capture 10 frames over	127
Capture NX 2	126, 160, 172
CEC	104
Center-weighted (Metering)	130
Charging a battery	10
Clock	19, 20, 168
Clock battery	20
Close up	27
Color temperature	153
Combine 4-second movies	119
Combine NMS movies	120
Compatible lens	171
Computer	96
Continuous	69
Continuous AF	134
Contrast	132, 157
Creative mode	32
Creative palette	33, 41
Crop	116
Crop (PictBridge)	106
Cross process	33, 44
Custom Picture Control	156, 159

D

Date and time	19, 168
Date format	19, 168
Daylight saving time	19, 168
DCF version 2.0	207
Defaults	183
Delete	26, 52, 63, 68, 91
Delete all images	91
Delete selected images	91
Detailed display	4, 165
Detailed photo information	86, 165
Digital Print Order Format	207
Display	165
Display brightness	165
D-Lighting	114
DPOF	108, 109, 207
DPOF print order	108, 109
Dust shield	176, 177

E

Edit movie	117
Electronic VR	134
Exif version 2.3	207
Exposure	73, 124, 130
Exposure compensation	73
Exposure indicator	39
Exposure mode	124

F

Face priority	28, 140
Face-priority zoom	117
Fast motion	48
File format	129
Fill flash	77
Filter effects	157, 158
Filter strength	129
Fine-tuning white balance	150
Firmware version	170
Flash	74, 141, 142
Flash compensation	142
Flash control	141
Flash mode	75, 77



Flash range	79
Flash-ready indicator	78
Flexible program	35
Flicker reduction	167
Focal length	86
Focal length scale	200
Focal plane mark	2, 137
Focus	134, 138
Focus area	23, 138
Focus lock	139
Focus mode	134
Format	13, 164
Format memory card	13, 164
Frame rate	85, 145, 146
Frame size/frame rate	146
Frames saved (default)	127
FT1	203
Full-frame playback	25, 85
Full-time AF	134

G

Grid display	24
--------------------	----

H

H.264	196
HD movie	48, 146
HDMI	103, 207
HDMI device control	104
HDMI-CEC	104
HDR	42
High definition	103, 207
High ISO noise reduction	161
Histogram	87
Hue	157
Hue (Cross process)	44

I

Image processing menu	148
Image quality	125
Image review	113
Image selection	112
Image size	125
Index print	108

ISO sensitivity	154
-----------------------	-----

J

JPEG	125
Jump cut	48

L

Landscape	27, 155
Language	19, 168
Lens	15, 28, 133, 171, 198, 199
Lens cap	16
Lens mount	137
Live image control	30
Load from/save to card	160
Long exposure NR	133

M

Manual	33, 38, 124
Manual focus	136
Matrix (Metering)	130
Max. shots per minute	147
Maximum aperture	198, 199
Memory card ... 12, 14, 164, 173, 184	
Memory card access lamp	24
Memory card capacity	184
Metering	130
Microphone	46, 147
microSD card	173
Miniature effect	33
Monitor	4, 165
Monochrome	155
Motion Snapshot mode	64
Mount adapter	171, 203
MOV	126, 129, 185
Movie before/after	128
Movie menu	143
Movie sound options	147
Movie-record button	46
Movies	45, 48, 146
Multi selector	5

N

NEF (RAW)	125, 126
-----------------	----------



Neutral	155
Nikon Transfer 2	101
NMS	126, 129, 185
Number of copies	106
Number of shots saved	127

O

On release, record	127
Optical VR	133

P

Page size (PictBridge)	106
Photo information	85
PictBridge	105, 207
Picture Control	155, 159
Pixel mapping	170
Playback	25, 85
Playback menu	110
Playback zoom	90
Portrait	27, 155
Portrait (Soft)	129
Power connector	171, 174
Power drive zoom	28
Power switch	17
Preset manual	149, 151
Press the shutter-release button all the way down	24, 27
Press the shutter-release button halfway	23, 27
Print border	106
Print date	109
Print DPOF print order	108
Print time stamp	106
Printing	105
Programmed auto	33, 35, 124
Protect	113

Q

Quick adjust	157
--------------------	-----

R

Rating	92, 113
Rear-curtain sync	77

Red-eye reduction	75, 77
Removing the lens from the camera 16	
Reset file numbering	167
Reset movie options	145
Reset processing options	149
Reset setup options	164
Reset shooting options	124
Resize	115
Retractable lens barrel button	16, 18, 200
Rotate tall	113

S

Saturation	157
Saturation (Toy camera effect) ...	130
Scene auto selector	124
Scene selection	33
Select color	43
Select images for printing	108
Select to send to smart device	83
Selective color	33, 43
Self-timer	71
Sensitivity	154
Setup menu	162
Sharpening	157
Shooting menu	121
Shutter button AE lock	166
Shutter speed	36, 38
Shutter-priority auto	33, 36, 124
Shutter-release button	23, 27, 56, 59, 65, 166
Silent photography	166
Single AF	134
Single frame	70
Single-point	138
Size	115, 125, 146, 193, 196
Slide show	93
Slot empty release lock	164
Slow motion	48, 145
Slow sync	77
Smart Photo Selector	58



Soft	33, 129
Sound settings	166
Speaker	3
Spot (Metering)	130
Standard	155
Start printing (PictBridge)	107
Strap	10
Subject tracking	138
System requirements	98

Zoom ring	16, 28, 200
-----------------	-------------

T

Television	103
Temperature warnings	xvi
Thumbnail playback	88
Time	19, 168
Time stamp (PictBridge)	106
Time zone and date	168
Timer	71
Toning	157, 158
Toy camera effect	33, 130
Trimming movies	117

U

Underwater	149
Underwater flash units	172
USB	80, 100, 105
USB cable	100, 105

V

ViewNX 2	96
Vignetting	130
Vivid	155
Volume	51, 95
VR	133, 134

W

Waterproof case	149, 171
White balance	149
Wi-Fi upload	82, 110
Wind noise reduction	147
Wireless mobile adapter	80, 172

Z

Zoom guide	28
------------------	----



No reproduction in any form of this manual, in whole or in part (except for brief quotation in critical articles or reviews), may be made without written authorization from NIKON CORPORATION.