

DENVER®

Instruction Manual

Alarm Clock

CRL-330NR



www.facebook.com/denverelectronics

www.denver-electronics.com

Before operating this product, please read this instruction manual carefully and completely.

Product Information

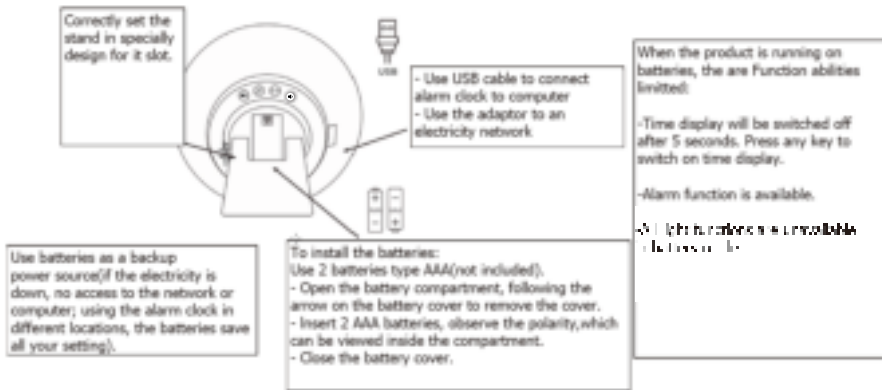





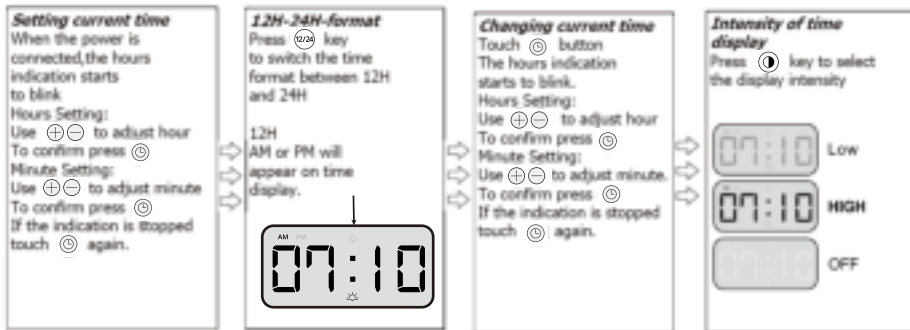













EN	EN
Correctly set the stand in specially design for it slot.	Correctly set the stand in specially design for it slot.
- Use USB cable to connect alarm clock to computer	- Use USB cable to connect alarm clock to computer
- Use the adaptor to an electricity network	- Use the adaptor to an electricity network
Use batteries as a backup power source (if the electricity is down, no access to the network or computer; using the alarm clock in different locations, the batteries save all your setting)	Use batteries as a backup power source (if the electricity is down, no access to the network or computer; using the alarm clock in different locations, the batteries save all your setting)
To install the batteries:	To install the batteries:
Use 2 batteries type AAA (not included).	Use 2 batteries type AAA (not included).

- Open the battery compartment, following the arrow on the battery cover to remove the cover.	- Open the battery compartment, following the arrow on the battery cover to remove the cover.
- Insert 2 AAA batteries, observe the polarity, which can be viewed inside the compartment.	- Insert 2 AAA batteries, observe the polarity, which can be viewed inside the compartment.
- Close the battery cover.	- Close the battery cover.
When the product is running on batteries, they are Function abilities limited:	When the product is running on batteries, they are Function abilities limited:
- Time display will be switched off after 5 seconds. Press any key to switch on time display.	- Time display will be switched off after 5 seconds. Press any key to switch on time display.
- Alarm function is available.	- Alarm function is available.
- All light functions are unavailable in battery mode	- All light functions are unavailable in battery mode





EN	EN
Setting current time	Setting current time
When the power is connected, the hours indication starts to blink	When the power is connected, the hours indication starts to blink
Hours Setting:	Hours Setting:
Use to adjust hour	Use to adjust hour
To confirm press	To confirm press
Minute Setting:	Minute Setting:
Use to adjust minute	Use to adjust minute
To confirm press	To confirm press
If the indication is stopped touch again.	If the indication is stopped touch again.
12H-24H-format	12H-24H-format
Press key to switch the time format between 12H and 24H	Press key to switch the time format between 12H and 24H
12H AM or PM will appear on time display.	12H AM or PM will appear on time display.
Changing current time	Changing current time

Touch  button	Touch  button
The hours indication starts to blink.	The hours indication starts to blink.
Hours Setting:	Hours Setting:
Use   to adjust hour	Use   to adjust hour
To confirm press 	To confirm press 
Minute Setting:	Minute Setting:
Use   to adjust minute.	Use   to adjust minute.
To confirm press 	To confirm press 
If the indication is stopped touch  again.	If the indication is stopped touch  again.
<i>Intensity of time display</i>	<i>Intensity of time display</i>
Press  key to select the display intensity	Press  key to select the display intensity
LOW	LOW
HIGH	HIGH
OFF	OFF

Sunrise light simulation

When the alarm time is set, the wake up light will switch on 30 minutes before the alarm time in low brightness and gradually increase the brightness. At the alarm time the brightness will be full. The natural sound will be played for 2 minutes at the alarm time.

During wake up alarm play

- Touch  button to snooze the alarm for 5 minutes. After 5 minutes the alarm will play again for 2 minutes. Press or touch any buttons except  to stop sound.
- Press and hold  to switch off wake up light.

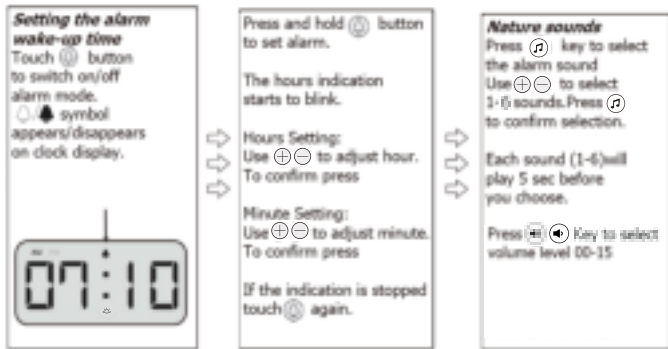

EN	EN
<i>Setting the alarm wake-up time</i>	<i>Setting the alarm wake-up time</i>
Touch button to switch on/off alarm mode.	Touch button to switch on/off alarm mode.
symbol appears/disappears on clock display.	symbol appears/disappears on clock display.
Press and hold button to set alarm.	Press and hold button to set alarm.
The hours indication starts to blink.	The hours indication starts to blink.

Hours Setting:	Hours Setting:
Use to adjust hour.	Use to adjust hour.
To confirm press	To confirm press
Minute Setting:	Minute Setting:
Use to adjust minute.	Use to adjust minute.
To confirm press	To confirm press
If the indication is stopped touch again.	If the indication is stopped touch again.
Nature sounds	Nature sounds
Press key to select the alarm sound	Press key to select the alarm sound
Use to select 1-6 sounds. Press to confirm selection.	Use to select 1-6 sounds. Press to confirm selection.
Each sound (1-6) will play 5 sec before you choose.	Each sound (1-6) will play 5 sec before you choose.
Press Key to select volume level 00-15	Press Key to select volume level 00-15

Setting the Sunset time

Touch to switch on/off sunset mode

/ symbol appears/disappears on time display.

Press and hold to set. The hours indication starts to set.

Hours Setting:

Use to adjust hours. To confirm press

minute setting:

Use to adjust minute. To confirm press



Light

Touch to switch on the light

Use to adjust the level (1-10) of the brightness
Second touch of will switch on automatic color changing mode

Use to select color: Green, Red, Blue, Purple, Orange, Indigo

Third touch to switch off the light

EN	EN
<i>Setting the Sunset time</i>	<i>Setting the Sunset time</i>
Touch ☺ to switch on/off sunset mode ☀/🌄 symbol appears/disappears on time display.	Touch ☺ to switch on/off sunset mode ☀/🌄 symbol appears/disappears on time display.
Press and hold ☺ to set	Press and hold ☺ to set
The hours indication starts to set.	The hours indication starts to set.
Hours Setting:	Hours Setting:
Use ⊕⊖ to adjust hours.To confirm press ☺	Use ⊕⊖ to adjust hours.To confirm press ☺
minute setting:	minute setting:
Use ⊕⊖ to adjust minute. To confirm press ☺	Use ⊕⊖ to adjust minute. To confirm press ☺
<i>Light</i>	<i>Light</i>
Touch ☺ to switch on the light	Touch ☺ to switch on the light
Use ⊕⊖ to adjust the level (1-10) of the brightness	Use ⊕⊖ to adjust the level (1-10) of the brightness
Second touch of ☺ will switch on automatic color changing mode	Second touch of ☺ will switch on automatic color changing mode
Use ⊕⊖ to select color: Green, Red, Blue, Purple, Orange, Indigo	Use ⊕⊖ to select color: Green, Red, Blue, Purple, Orange, Indigo
Third touch ☺ to switch off the light	Third touch ☺ to switch off the light

Sunset light simulation



30 min before sunset time, the light is turned on with 100% brightness and then the brightness is reduced gradually and will turn off at sunset time.

During sunset light is turned on you may: Press and hold  to turn off the light.

Description

- * Led time display in 12H-24 format
- * Sunrise wake up light simulation
- * Sunset light simulation
- * 6 Nature sounds to wake up
- * Bedside lamp
- * White light flux: 73LM
- * 10 levels of the brightness
- * 6 coloured light+white light
- * Automatic changing of color light
- * 15 volume levels
- * Touch mode
- * Power supply: DC 5V; 2xAAA batteries; USB cable.

Note: When the battery is low the product may not function properly.
Replace the battery with fresh battery.



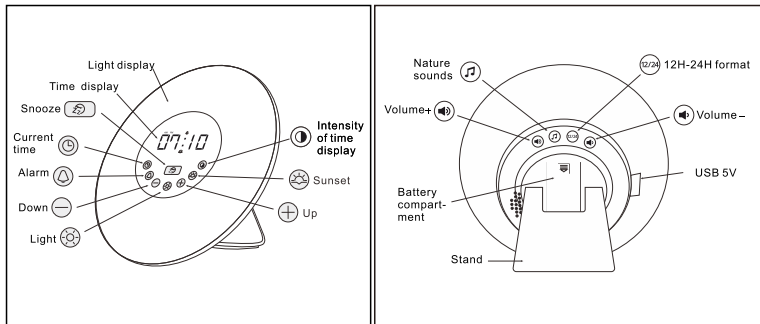

EN	EN
Light display	Light display
Time display	Time display
Snooze	Snooze
Current time	Current time
Alarm	Alarm
Down i	Down i
Light	Light
Sunset	Sunset
Up	Up
Nature sounds	Nature sounds
Volume -/+	Volume -/+
Battery compartment	Battery compartment
Stand	Stand
12H-24H format	12H-24H format
Intensity of time display	Intensity of time display
USB 5V	USB 5V



warning

- * Don't press two or more keys at the same time
- * To avoid failure interval of every touch must be more than 1 second.
- * If there is any malfunction, please unplug the unit for 3 seconds.
- * If the batteries are not used for a long time, please remove.
- * When the batteries voltage is low, the product will get restarted and all settings are lost. Please replace new batteries.
- * The adapter is designed to use with this product only, Please do not use the adapter to charge other devices like Mobile Phone.



warning

ALL RIGHTS RESERVED, COPYRIGHT DENVER ELECTRONICS A/S

DENVER™

www.denverelectronics.com



Electric and electronic equipment contains materials, components and substances that can be hazardous to your health and the environment, if the waste material (discarded electric and electronic equipment) is not handled correctly.

Electric and electronic equipment is marked with the crossed out trash can symbol, seen above. This symbol signifies that electric and electronic equipment should not be disposed of with other household waste, but should be disposed of separately.

All cities have established collection points, where electric and electronic equipment can either be submitted free of charge at recycling stations and other collection sites, or be collected from the households. Additional information is available at the technical department of your city.

Imported by:

DENVER ELECTRONICS A/S

Omega 5A, Soeften

DK-8382 Hinnerup

www.facebook.com/denverelectronics