

GRANNY SMITH

Pendant lamp

Manual
Handleiding
Handbók
Bruksanvisning
Instruktioner
инструкции
Instruċijoni
Упатство
Utasítás
Inštrukcia
Manuel

Rokasgrāmata
Manwal
Instrukcije
Manuál
Priročnik
Instrucciones
Talimatlar
Handbuch
Hânlíeding
Torolalana
Manuale



VAN
TJALLE
EN
JASPER



1

GRANNY SMITH

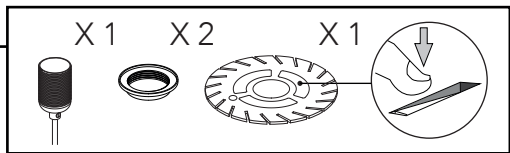

1

2

3

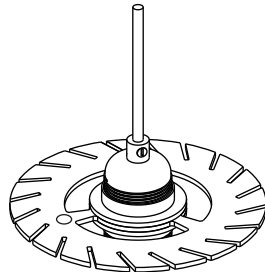
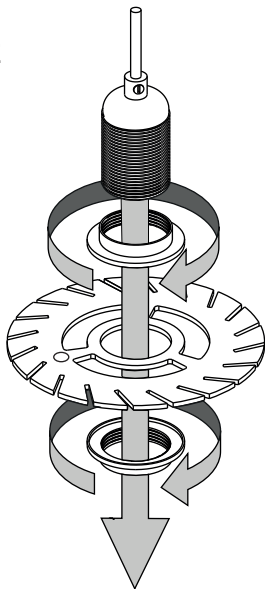
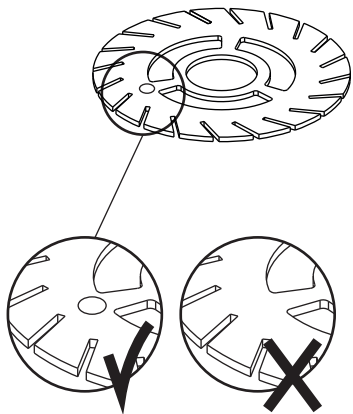

2

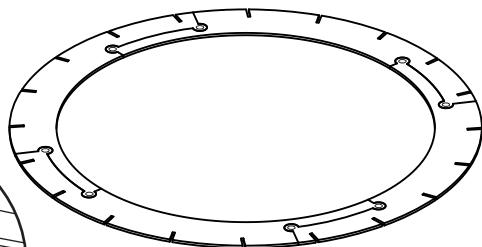
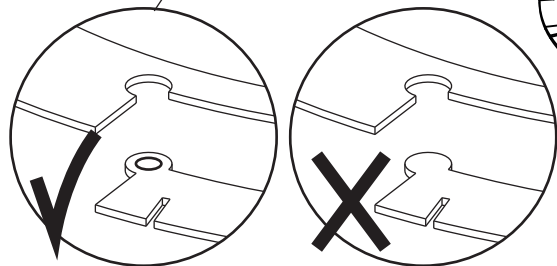
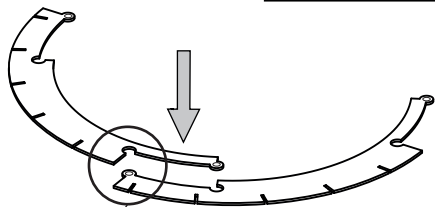
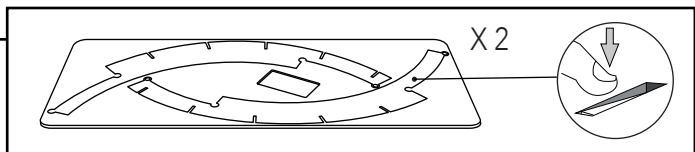

3

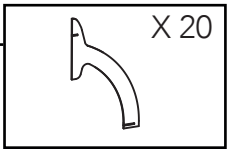

♪ CLICK

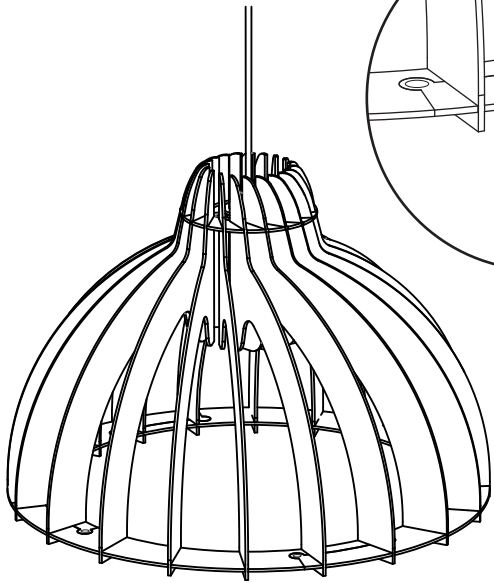
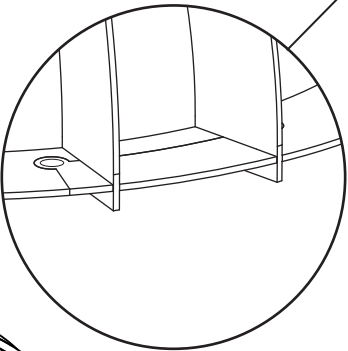
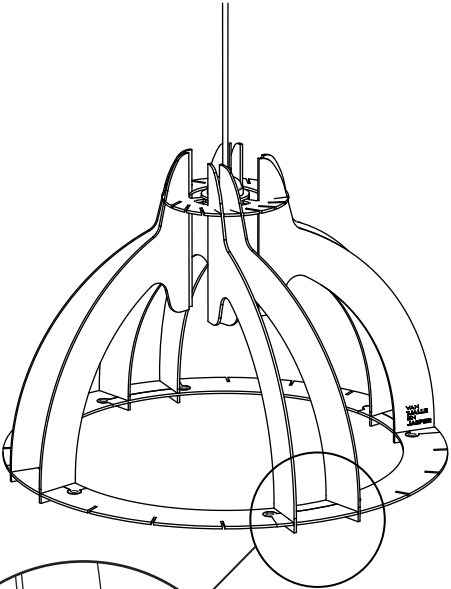
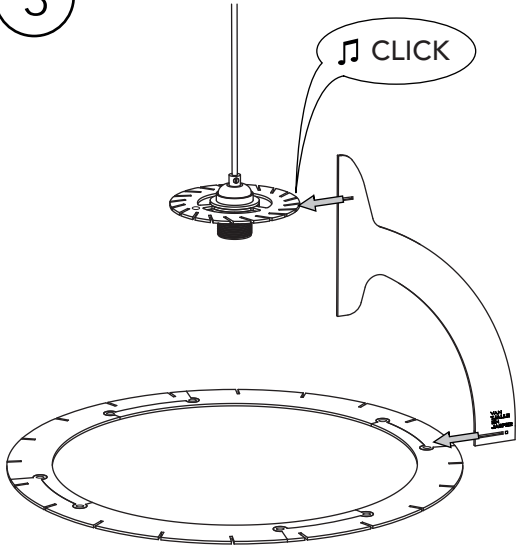

4

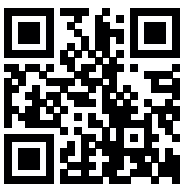
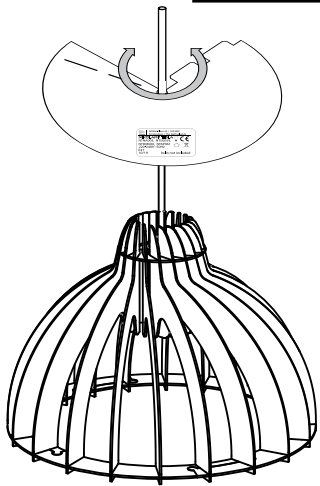
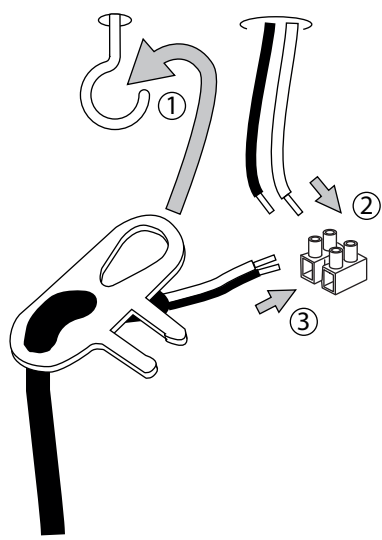
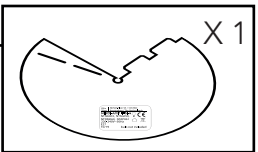

5

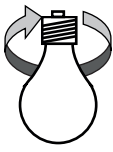
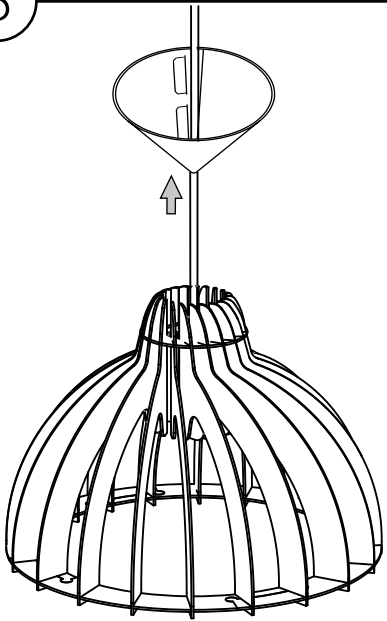

LED - E27
max 10 Watt