



8531-1

1.

- x1 (1x6 white Technic brick)
- x1 (1x2 black Technic axle)
- x1 (1x2 grey Technic axle)
- x1 (1x2 grey Technic axle)
- x2 (1x2 grey Technic axle)

2.

- x2 (1x2 grey Technic axle)
- x2 (1x2 grey Technic axle)
- x1 (1x2 grey Technic axle)
- x1 (1x2 grey Technic axle)
- x2 (1x2 grey Technic axle)
- x1 (1x2 grey Technic axle)

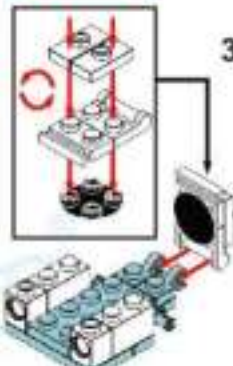

3.

- x1 (1x6 white Technic brick)
- x2 (1x2 red Technic axle)
- x4 (1x2 grey Technic axle)
- x2 (1x2 grey Technic axle)

4.

- x1 (1x6 white Technic brick)
- x1 (1x2 grey Technic axle)
- x1 (1x2 grey Technic axle)

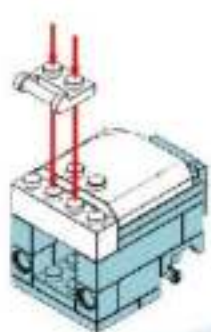

5.

- x2 (1x2 grey Technic axle)
- x2 (1x2 grey Technic axle)
- x2 (1x2 grey Technic axle)

6.

- x1 (1x2 black Technic axle)
- x2 (1x2 grey Technic axle)
- x2 (1x2 grey Technic axle)

7.

- x1 (1x6 white Technic brick)
- x2 (1x2 grey Technic axle)
- x1 (1x2 grey Technic axle)

8.

- x1 (1x6 white Technic brick)
- x1 (1x2 red Technic axle)
- x1 (1x2 grey Technic axle)
- x1 (1x2 grey Technic axle)
- x1 (1x2 grey Technic axle)
- x1 (1x2 grey Technic axle)

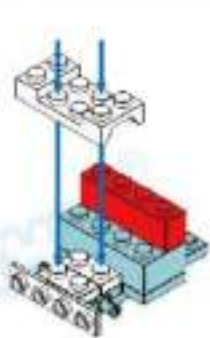

9.

- x1 (1x2 red Technic axle)
- x1 (1x2 grey Technic axle)
- x1 (1x2 grey Technic axle)
- x2 (1x2 grey Technic axle)
- x1 (1x2 grey Technic axle)
- x2 (1x2 grey Technic axle)

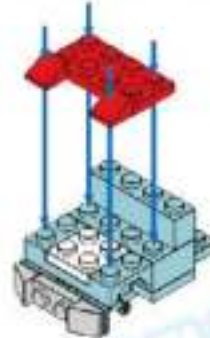

10.

- x1 (1x6 white Technic brick)
- x1 (1x2 red Technic axle)
- x1 (1x2 grey Technic axle)
- x1 (1x2 grey Technic axle)
- x1 (1x2 grey Technic axle)
- x1 (1x2 grey Technic axle)
- x2 (1x2 grey Technic axle)



11.

- x1 (1x6 white Technic brick)
- x1 (1x2 grey Technic axle)
- x1 (1x2 grey Technic axle)
- x2 (1x2 grey Technic axle)

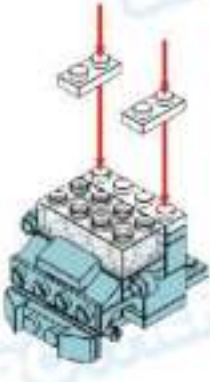

12.

- x2 (1x2 grey Technic axle)
- x1 (1x2 grey Technic axle)
- x2 (1x2 grey Technic axle)

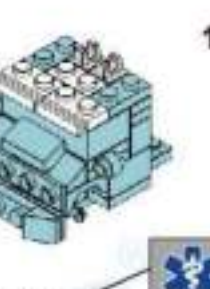

13.

- x1 (1x2 grey Technic axle)
- x3 (1x2 grey Technic axle)
- x1 (1x2 grey Technic axle)
- x1 (1x2 grey Technic axle)
- x1 (1x2 grey Technic axle)
- x2 (1x2 grey Technic axle)



14.

- 5 (1x5 white Technic axle)



15.

- x4 (1x2 grey Technic axle)

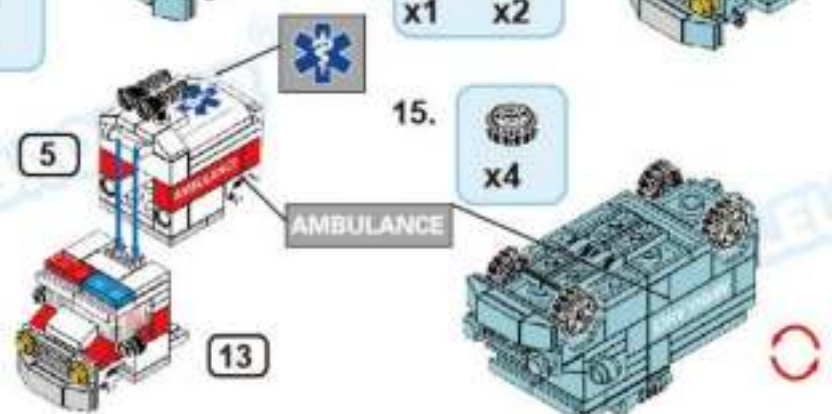





8531-2

1. x4 x2 x1 x1 x1

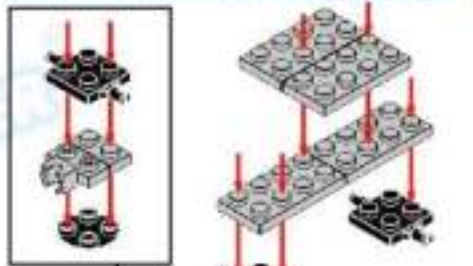

2. x2 x2 x2 x4

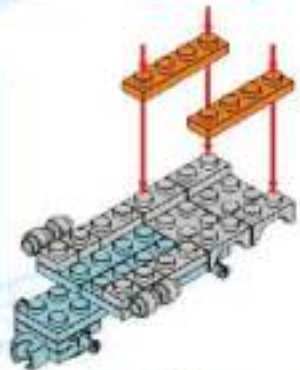

3. x1 x1 x2

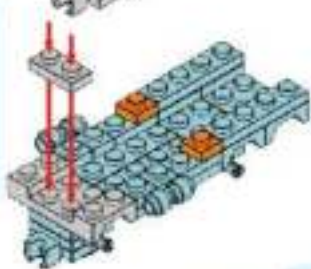

4. x1 x1 x1 x1

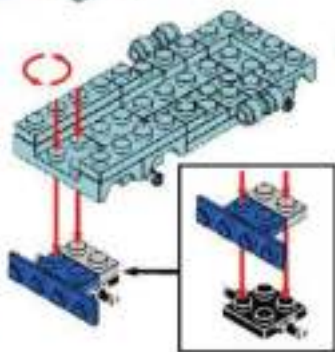

5. x3 x2 x2 x1 x2

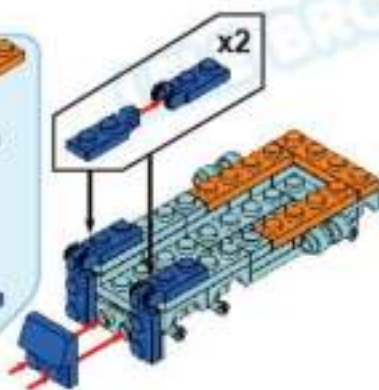

6. x1 x2 x2 x2

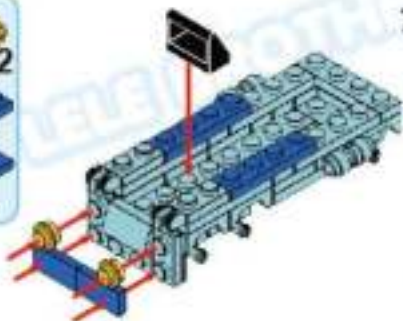

7. x2 x2 x2 x2



8. x1 x2 x2

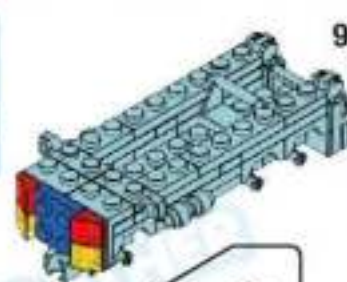

9. x4 x1 x1



10. x1 x1 x1

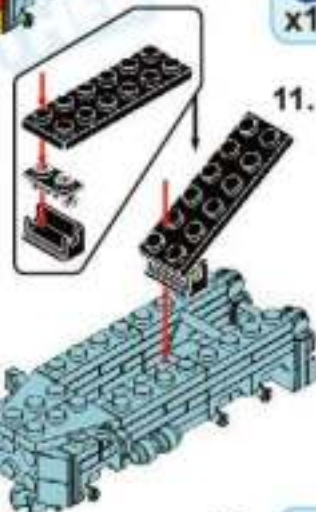

11. x1 x1 x2

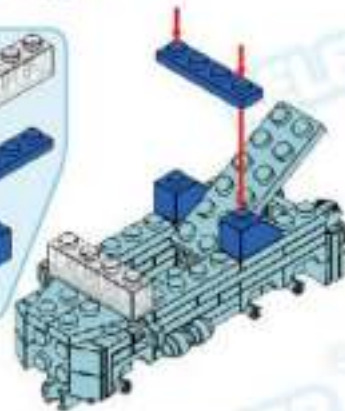

12. x2 x2 x8

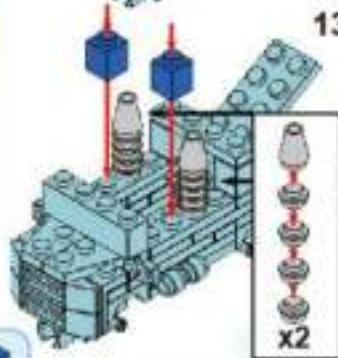

13. x1 x1 x2



14. x2 x1 x1 x1 x1 x1

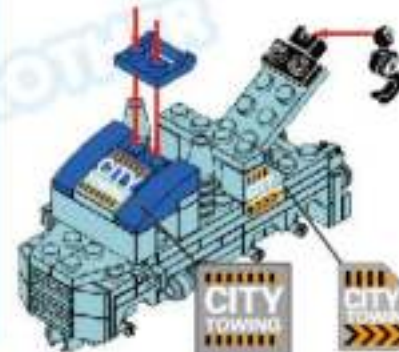

15. x6

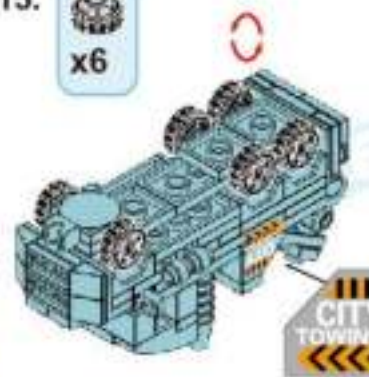





8531-3

1.

- x1 [1x6 Technic Plate]
- x2 [1x2 Technic Pin]
- x2 [1x2 Technic Pin]
- x2 [1x2 Technic Pin]
- x4 [1x2 Technic Pin]

8.

- x2 [1x2 Technic Pin]
- x2 [1x2 Technic Pin]
- x2 [1x2 Technic Pin]
- x2 [1x2 Technic Pin]

9.

- x4 [1x2 Technic Pin]
- x2 [1x2 Technic Pin]

2.

- x1 [1x6 Technic Plate]
- x1 [1x2 Technic Pin]
- x1 [1x2 Technic Pin]
- x2 [1x2 Technic Pin]
- x2 [1x2 Technic Pin]

3.

- x2 [1x2 Technic Pin]
- x1 [1x2 Technic Pin]
- x1 [1x2 Technic Pin]
- x1 [1x2 Technic Pin]
- x2 [1x2 Technic Pin]
- x2 [1x2 Technic Pin]

10.

- x1 [1x6 Technic Plate]
- x1 [1x2 Technic Pin]
- x1 [1x2 Technic Pin]
- x1 [1x2 Technic Pin]

11.

- x2 [1x2 Technic Pin]
- x2 [1x2 Technic Pin]
- x1 [1x2 Technic Pin]
- x1 [1x2 Technic Pin]

4.

- x1 [1x2 Technic Pin]
- x1 [1x2 Technic Pin]
- x2 [1x2 Technic Pin]

5.

- x1 [1x2 Technic Pin]
- x2 [1x2 Technic Pin]
- x2 [1x2 Technic Pin]

6.

- x1 [1x2 Technic Pin]
- x2 [1x2 Technic Pin]

7.

- x2 [1x2 Technic Pin]
- x2 [1x2 Technic Pin]
- x1 [1x2 Technic Pin]
- x1 [1x2 Technic Pin]
- x3 [1x2 Technic Pin]
- x1 [1x2 Technic Pin]

12.

- x2 [1x2 Technic Pin]
- x2 [1x2 Technic Pin]

POLICE

13.

- x4 [1x2 Technic Pin]
- x4 [1x2 Technic Pin]









1.

- x2
- x1
- x2

8.

- x1
- x1
- x1
- x2

9.

- x1
- x1
- x2
- x1
- x2

2.

- x1
- x1
- x1
- x2

3.

- x2
- x2
- x2
- x1

10.

- x1
- x1
- x1
- x3

11.

- x2
- x2
- x1
- x1
- x2
- x1
- x2

4.

- x1
- x1
- x2
- x2
- x1

5.

- x1
- x1
- x2
- x2
- x2
- x2

12.

- x2
- x1
- x1
- x2
- x1

13.

- x1
- x2
- x1
- x1
- x1
- x1

6.

- x1
- x1
- x6
- x1

7.

- x1
- x1
- x1
- x2

14.

FIRE RESCUE

6

13

15.

- x6





1.

- x1
- x1
- x1
- x1

2.

- x4
- x2

3.

- x1
- x1
- x1
- x2

4.

- x1
- x1
- x1
- x2

5.

- x1
- x1
- x1
- x2

6.

- x2
- x2
- x1
- x1
- x2

7.

- x1

8.

- x1
- x1
- x2

9.

- x2
- x2
- x2

10.

- x1
- x1
- x1
- x2
- x2

11.

- x1
- x1
- x1
- x2
- x2

12.

13.

- x6
- x6





1.



QuchiQ



2.



3.

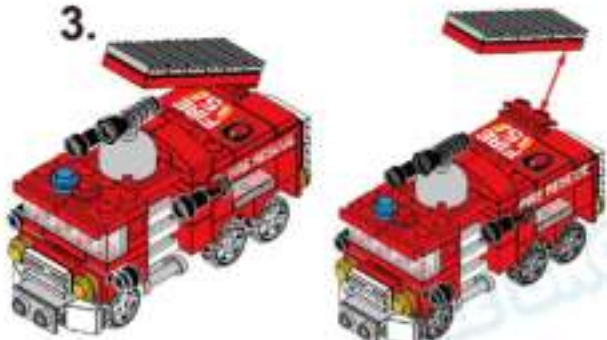

4.



5.



6.



7.



8.



9.

QuchiQ

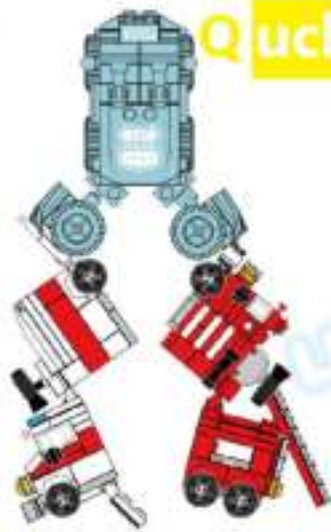

10.



12.



13.

