

SCHNEIDER

REFRIGERATOR

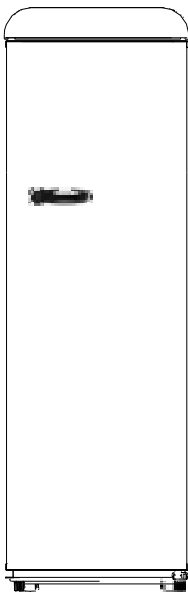

**SCCL329VR, SCCL329VB,
SCCL329VBL, SCCL329VCR**

Notice of use

Please read the following instructions carefully before using this device.
Please keep these instructions for future reference.



THIS APPLIANCE IS FOR HOUSEHOLD
USE ONLY!

Please read all instructions carefully before first use and save them for future reference.

IMPORTANT SAFETY INSTRUCTIONS

Please read the following operating instructions carefully before connecting your new device, they contain important information on safety, how to use, install and keep your device in working order. Please keep these instructions for future reference.

1. This device can be used by children from 8 years old and by people with reduced physical, sensory or mental capacities or a lack of experience and knowledge provided they have been placed under supervision or have received instructions regarding safe use of the device and understand the dangers involved. Children must

not play with the device. Cleaning and user maintenance should not be made by children without supervision.

2. Before plugging in the appliance, make sure that the voltage of the mains socket in your home matches that shown on the rating plate.
3. Do not damage the cooling circuit. This warning is only valid for devices whose cooling circuit is accessible by the user.
4. Make sure the appliance is unplugged before cleaning.
5. To clean this unit, use a damp cloth or glass cleaner. Never use detergent or solvent.
6. When defrost has been carried out, or when the refrigerator stops to be used, clean the appliance to prevent the spread of odor. Too much gel can affect refrigeration.

7. It is recommended to use this device without an electrical extension.
8. In order to ensure good ventilation of the device, essential for its proper functioning, it is recommended to have a minimum clearance (or space) of 10mm on the sides and at the back and 20mm on the top.
9. Do not place any hot food or drink in the appliance.
10. In order to save electricity consumption, keep air circulation around the appliance and discard food wrappers before putting them in the refrigerator as soon as possible.
11. Do not store toxic materials such as ether, methanol, gasoline, etc., which are volatile and can burn or explode in them.

12. Do not place flammable materials in the refrigerator unless they have been authorized by the manufacturer.
13. Close the door after use to avoid temperature loss.
14. This product should not be used outdoors and should not be exposed to rain.
15. The device must be placed on a flat and stable surface.
16. The appliance must be placed so that the socket is easily accessible.
17. Do not place heavy objects on the refrigerator and do not wet it.
18. To avoid the risk of electric shock, never use this appliance with wet hands or bare feet on a wet surface.
19. Do not use the device outdoors or in a humid place.
20. Do not move the device when it is full to avoid tipping.

21. The power cable must be plugged into a grounded outlet. Never pull on the cable to disconnect the appliance, grasp the plug and pull it out from the socket.
22. Never lift the device by the power cable.
23. Keep the power cable away from heated surfaces.
24. Do not attempt to repair, adjust, or replace any part of this appliance yourself. In the event of a malfunction, contact the after-sales service.
25. Children should be supervised to ensure that they do not play with the appliance.
26. If the power cable is damaged, it must be replaced by the manufacturer, its after-sales service or similarly qualified persons in order to avoid any danger.
27. It is recommended to regularly examine the cable

power supply for any signs of damage, and the device should not be used if the cable is damaged.

28. The device is equipped with a grounding plug to protect you from possible electrical risks and must be connected to a socket outlet with an earth contact.
29. The devices are not intended to be operated by means of an external timer or by a separate remote-control system.
30. CAUTION: Keep the ventilation openings in the enclosure of the appliance, in its exterior part or in its built-in structure clear.
31. CAUTION: Do not damage the refrigeration circuit.
32. CAUTION: Do not use mechanical devices or other means to accelerate the defrosting processes, other than those recommended by the manufacturer.

33. CAUTION: Do not use electrical appliances inside the food storage compartment unless they are of the type recommended by the manufacturer.
34. This device is intended for use in household applications.
35. WARNING: When positioning the unit, make sure the power cord is not pinched or damaged.
36. WARNING: Do not place mobile multi-outlet cradles or portable power supplies on the back of the device.
37. Children aged 3 to 8 are allowed to load and unload refrigeration devices.
38. To avoid contamination of food, please observe the following instructions:

- Prolonged opening of the door can lead to a significant increase in temperature in the compartments of the appliance.
- Regularly clean surfaces that may come into contact with food and accessible drainage systems.
- Store raw meat and fish in suitable containers in the refrigerator, so that they do not come into contact with and drip onto other foods.
- If the refrigeration appliance is left empty for long periods of time, turn it off, defrost, clean, dry and leave the door open to prevent mold growth in the appliance.

39. Place the device against a wall whose free distance does not exceed 75 mm and exceeds 50 mm.
40. This refrigeration appliance is not intended for use as a built-in appliance.
41. When freezing fresh food with an “best before / best before / best date” date, you must freeze it before that date has expired.
42. Check that the food has not already been frozen. This is because frozen foods that have thawed completely should not be refrozen. Once thawed, food should be eaten quickly.

- To avoid spoilage of food due to transfer of germs: Store unpackaged animal and plant products separately in drawers. This also applies to different kinds of meat.
- If food needs to be kept together for lack of space: wrap it.
- Never store fruits and vegetables on a balcony with meat or fish.

| Food | Storage period |
|---------------------|-----------------------|
| Butter | 90 days |
| Hard cheese | 110 days |
| Milk | 7 days |
| Sausage, cold meats | 9 days |
| Meat | 7 days |

Only an authorized technician can change the lamp in the event of a fault.



Suitable for food

Refrigerant



Danger; risque d'incendie/
matières inflammables

**Danger ; fire hazard/
flammable materials**

The refrigerant gas contained in the circuit of this device is isobutane (R 600a), a low-polluting but flammable gas. When transporting and installing the appliance, take care not to damage any part of the refrigeration circuit.

WARNING: When position the device, make sure that the power cord is not trapped or damaged.

WARNING: Do not place multiple socket outlets or portable power supplies on the back of the device.

DESCRIPTION OF THE APPLIANCE

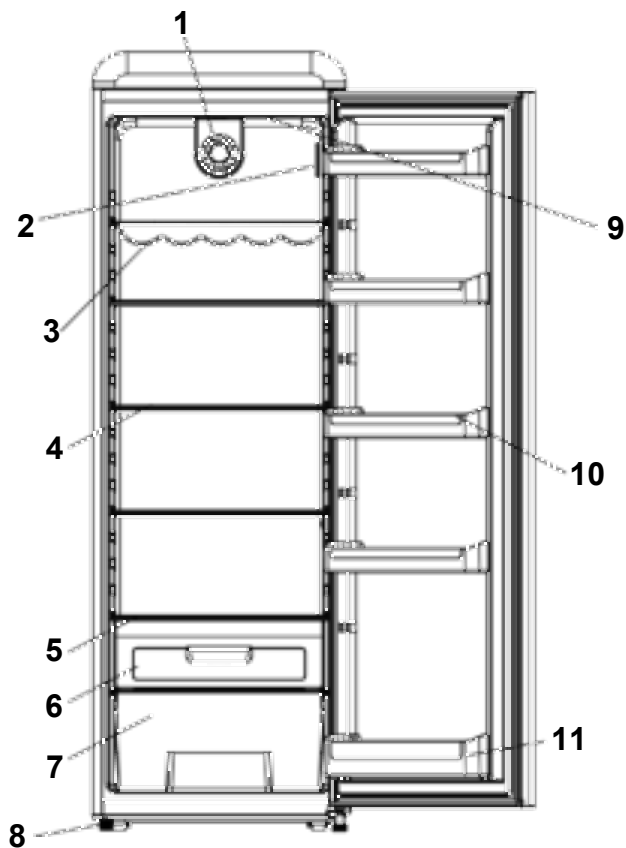

1. Fan
2. Temperature management section
3. Bottle shelf
4. Shelves
5. Vegetable drawer cover
6. Vegetable drawer
7. Vegetable drawer
8. Adjustable foot
9. LED ceiling lighting
10. Balcony
11. Bottle holders

TEMPERATURE CONTROL

Control panel



The display has two buttons (see image above):

1. Quick cooling button
2. Temperature selection button

- Before you start using this device and in order to obtain optimum performance, please read the display instructions. When you turn on the device for the first time, the icons on the panel will start to light up.
- When the product is plugged in, the screen lights up for 3 seconds with a long tone. You will hear a short tone each time you actually press a button.

SELECTING THE TEMPERATURE



In its initial configuration, the display panel indicates 5 ° C. The interior temperature can be set between 2 and 8 degrees.

The temperature will be set after 5 seconds (the icon will stop flashing).



QUICK COOLING



With this function, you can cool your food much faster, keeping it fresh for longer. Press the “fast cooling” button to activate the Fast-cooling mode. In temperature setting mode, press the Fast-Cooling button to enter this mode. The display shows “”, The operating time for this mode is 3 hours. After 3 hours, the rapid cooling mode will stop automatically, the temperature returns to the value set before the rapid cooling mode was activated.

TRANSPORT AND START-UP

When transporting, take the device by the base and gently tilt it up to a maximum of 45 °. Never lift the appliance by the door handle. Do not put the device upside down or horizontally. Push the refrigerator on the roller legs to move it.

INSTALLATION

Install the refrigerator on a flat and stable surface to avoid possible noise and vibrations from the appliance.

The refrigerator should be placed so that the outlet is easily accessible.

Choose a dry, well-ventilated place. Leave a space of at least 10mm all around the refrigerator and 20mm on the top.

Do not install the refrigerator in a corrosive atmosphere.

Wait 12 to 24 hours before plugging in the appliance.

WARNING !

When you install your refrigeration appliance, it is important to take into account the climatic class of the product. To find out which climate class your refrigerator belongs to, please check the data plate as shown below:

The refrigeration appliance operates correctly within the ambient temperature range shown in the table, depending on the climate class.

| Class | Symbol | Average ambient temperature ° C |
|--------------------|--------|---------------------------------|
| temperate enlarged | SN | from + 10 to + 32 |
| temperate | N | from + 16 to + 32 |
| subtropical | ST | from + 16 to + 38 |
| Tropical | T | from + 16 to + 43 |

PLACE

The device must be installed away from heat sources such as radiators, boilers, direct sunlight, etc.

Make sure that air can circulate freely around the back of the cabinet. To ensure optimum performance, if the appliance is placed under an overhanging wall unit, the minimum distance between the top of the booth and the wall unit must be at least 100 mm.

Ideally, the device should not be placed under a surface mounted wall unit. Precise leveling is provided by one or more adjustable feet at the base of the cabinet.

For refrigeration devices with a climatic class:

- extended temperate (SN): this refrigeration appliance is intended for use at ambient temperatures between 10 ° C and 32 ° C;
- temperate (N): this refrigeration appliance is intended for use at ambient temperatures between 16 ° C and 32 ° C;
- subtropical (ST): this refrigeration appliance is intended for use at ambient temperatures between 16 ° C and 38 ° C;
- tropical (T): this refrigeration appliance is intended for use in ambient temperatures between 16 ° C and 43 ° C.

Meaning of the *-labelling of freezers

- 1- (*), 2- (**), and 3-stars (***) freezers **are not suitable for freezing fresh food.**
- 2-stars (**) and 3-stars (***) freezers are suitable for storing frozen food (**pre-frozen**) and ice or for making ice and ice cubes.

| COMPARTMENTS | STARS (*) | TARGET STORAGE TEMPERATURE | SUITABLE FOOD |
|---------------------|-----------|----------------------------|--|
| FREEZER | (***)* | ≤ -18 °C | <ul style="list-style-type: none"> ➤ Suitable for seafood (fish, shrimps, shellfish), freshwater and meat products. ➤ Recommended storage period: 3 months ■ Suitable for freezing fresh food. |
| FREEZER | *** | ≤ -18 °C | <ul style="list-style-type: none"> ➤ Suitable for seafood (fish, shrimps, shellfish), freshwater and meat products. ➤ Recommended storage period: 3 months ■ Not suitable for freezing fresh food. |
| FREEZER | ** | ≤ -12 °C | <ul style="list-style-type: none"> ➤ Suitable for seafood (fish, shrimps, shellfish), freshwater and meat products. ➤ Recommended storage period: 2 months ■ Not suitable for freezing fresh food. |
| FREEZER | * | ≤ -6 °C | <ul style="list-style-type: none"> ➤ Suitable for seafood (fish, shrimps, shellfish), freshwater and meat products. ➤ Recommended storage period: 1 month ■ Not suitable for freezing fresh food. |
| 0* - COMPARTMENT | - | -6 °C - 0 °C | <ul style="list-style-type: none"> ➤ Suitable for fresh meat products (pork, beef, chicken, etc.) and processed food consumed or processed within the same day or within the next three days after storage (max.). ■ Not suitable for freezing food or for storing frozen food. |



Warning ! The appliance must be able to be disconnected from the electrical network; the plug must therefore be easily accessible after installation.

USE

Before first use, clean all parts of the refrigerator with a soft cloth dampened in lukewarm water and a mild detergent. Rinse them thoroughly with clean water and dry them with a dry cloth.

Note: The electrical parts of the refrigerator can only be cleaned with a dry cloth.

Place the thermostat knob in position "3", then turn on the appliance. The compressor is running and the interior light of the refrigerator comes on.

Close the door. After 30 minutes, if the temperature in the refrigerator drops significantly, it shows that the refrigeration system is working properly. When the refrigerator has been running for a while, the temperature will adjust to the setting made, provided you do not leave the door open for too long.

If the above steps have been completed successfully, the setup operations are complete. The refrigerator is operating normally.

The device is supplied with two plastic tips (in the plastic bag in the user manual). After installing these end caps, the unit can no longer be pushed against the wall to ensure adequate ventilation. Insert the end caps into the corresponding openings on the back of the device, then screw them on.

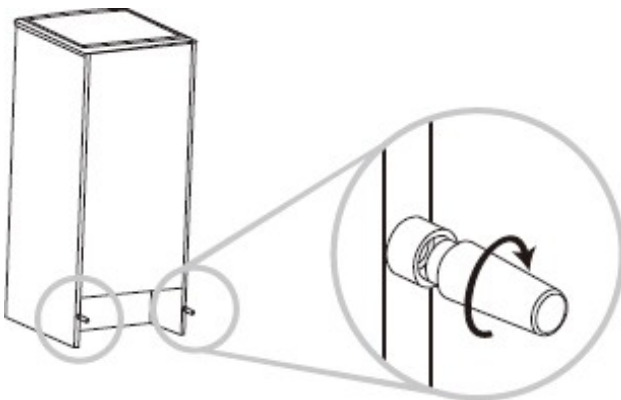

Place the device against a wall with a free distance not exceeding 50-75mm

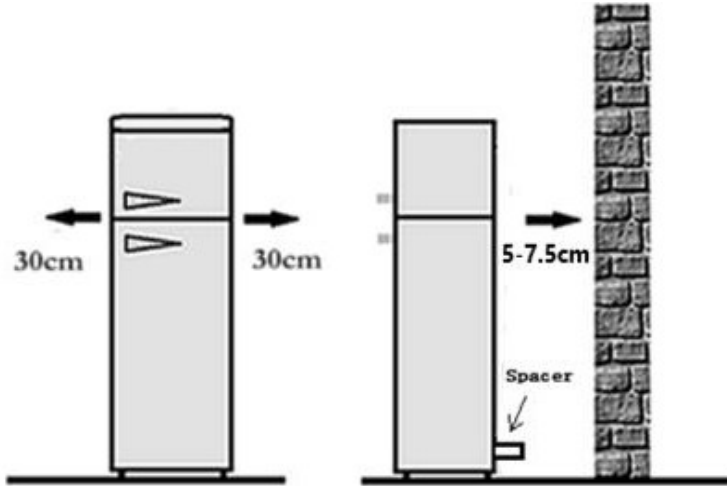

COLDEST ZONE IN THE REFRIGERATOR

This symbol below indicates the location of the coldest area in your refrigerator. This zone is delimited near the fan, and at the top by the symbol or by the shelf positioned at the same height.



In order to guarantee the temperatures in this zone, take care not to modify the positioning of this shelf.

Installing the temperature indicator

To help you adjust your refrigerator properly, it is equipped with a temperature indicator (delivered in the package insert) which will allow you to control the average temperature in the coldest area.

WARNING: This indicator is only intended for use with your refrigerator. Be careful not to use it in another refrigerator (indeed, the coldest zone is not the same), or for any other use.

Checking the temperature in the coldest area

Once the temperature indicator has been installed, you will be able to regularly check that the temperature of the coldest area is correct. If necessary, adjust the thermostat accordingly as indicated above. The interior temperature of the refrigerator is influenced by several factors such as the ambient temperature of the room, the amount of food stored and how often the door is opened. Take these factors into account when setting the temperature.

For the proper conservation of food in your refrigerator and in particular in the coldest area, make sure that the temperature indicator appears "OK".

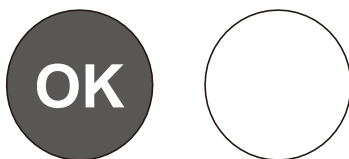

If "OK" does not appear, it means the temperature is too high. Set the thermostat to a higher position. Wait at least 12 hours before readjusting the thermostat. After loading fresh food into the appliance or after repeated openings (or extended opening) of the door, it is normal that the inscription "OK" does not appear in the temperature indicator.

FOOD STORAGE

- How to use the freezer compartment?
Place fresh foods such as fish, meat in the freezer compartment to preserve their taste and nutrients.
Wrap foods that need to be frozen in aluminum foil or in airtight plastic boxes.
Do not put fresh food in direct contact with other already frozen food.
If you buy frozen food, please keep it in the freezer compartment as soon as possible.
Never refreeze a thawed product.

- How to use the refrigerator compartment?
Eggs and bottles must be placed in the spaces reserved for this purpose.
Vegetables and fruits should be put in the vegetable drawer.
The jars should be placed in the shelves on the refrigerator door.
Other foods which are perishable or which may give off a bad odor in the refrigerator should be packaged separately.
- Food placement
Be careful not to over-place food in the refrigerator. Food should be wrapped separately in aluminum foil or in airtight plastic boxes. In order to save energy consumption, do not place hot food in the refrigerator.
Wait until they are well cooled before storing them.
Never put vegetables or fruit in the freezer compartment.

DEFROSTING

When the appliance has been in operation for a long time, the underside of the freezer compartment may become covered with a film of frost. This leads to increased power consumption and decreases the efficiency of your device. Your freezer compartment should be defrosted once a month.

When defrosting, unplug the appliance, open the door and remove all food. Then store the food in a cool place. Use a plastic scraper to remove the frost. Then wipe the freezer compartment with a soft, dry cloth.

Note: Never use a metal utensil to defrost the freezer compartment to avoid damaging it.

WARNING: Do not use any mechanical device or other means to accelerate defrosting other than those recommended by the manufacturer.

MAINTENANCE AND CLEANING

- The device should be cleaned at least once a month.
- Before cleaning, be sure to switch off and unplug the appliance.
- Remove all accessories. Wash them in lukewarm water with a mild detergent (dish soap for example), rinse with bleach and dry thoroughly.
- Wipe the inside and outside of the refrigerator with a damp, soft cloth.
- If the device is too dirty, clean it with a soft cloth dampened with a little mild detergent, rinse the device thoroughly and dry it with a soft cloth.

If you need to go on vacation or not use the device for a long time, please do the following:

- Switch off the device and unplug it from the outlet.
- Remove all food.
- Clean and dry the inside of the device by following the above instructions.
- Leave the appliance door open to avoid any bad odors.

Cleaning

Before cleaning, be sure to switch off and unplug the appliance.

Use a soft cloth soaked in water or non-abrasive detergent to clean the device. Then wipe off the moisture with a soft, dry cloth.

Remember to clean the water collection tray located at the back, above the glass cover.

REPAIR

| Symptom | Raison | Solution |
|--|--|---|
| The device does not work | No power supply | Make sure the device is plugged in properly and the wall outlet is working normally |
| | The fuse has blown. | Replace the fuse |
| The device makes a lot of noise | The device is not parallel to the ground. The appliance is too close to the wall or the interior accessories of the refrigerator are placed incorrectly. | Stabilize the base of the refrigerator by adjusting the position of the feet. Move the device away from the wall. Correctly place the interior accessories of the refrigerator. |
| The device does not desired temperature. | The door is open too often or has been left open for a long time. | Close the door and don't don't open it too much frequently. |
| | The refrigerator is too close to the wall. | Move the unit away from the wall to ensure proper. |
| | The refrigerator is too full. | Remove food from the appliance. |
| | The temperature is incorrectly regulated. | Turn the thermostat knob to the position "3" or more. |
| The device gives off bad odors. | | |
| | The interior of the need to be cleaned. | Clean the inside of the device. |

If your device shows other symptoms than those described above, please call the authorized service center of the store or the dealer.

The following symptoms are not failures:

1. The sound of coolant flowing through the pipes can be heard, this is normal.
2. Moisture on the exterior of the unit during wet seasons is not a problem, just wipe the surfaces with a soft, dry cloth.
3. The compressor and condenser can heat up more during periods of high heat.
4. The door frame is a little warm, it means the condenser is working to remove moisture from the air.

TECHNICAL SPECIFICATIONS

ENERGY LABELING REGULATION DATA SHEET: 2019/2016 / EU

The product information sheet according to EU regulation n ° 2019/2016

The energy labeling of refrigeration devices can be found under the URL or QR code indicated on the energy label:

SCCL329VR - URL: <https://eprel.ec.europa.eu/qr/573587>

SCCL329VB - URL: <https://eprel.ec.europa.eu/qr/503744>

SCCL329VBL - URL: <https://eprel.ec.europa.eu/qr/523658>

SCCL329VCR - URL: <https://eprel.ec.europa.eu/qr/573629>

WARRANTY EXCLUSIONS:

The warranty does not cover wearing parts of the product, nor problems or damage resulting from:

- (1) Surface deterioration due to normal wear and tear of the product;
- (2) Defects or deterioration due to contact of the product with food or liquids and due to corrosion caused by rust or the presence of insects;
- (3) Any unauthorized incident, abuse, misuse, modification, disassembly or repair;
- (4) Any improper maintenance operation, use not in accordance with the instructions concerning the product or connection to an incorrect voltage;
- (5) Any use of accessories not supplied or approved by the manufacturer.

The warranty will be void if the nameplate and / or serial number of the product is removed.

Product warranty and spare parts available

Under the terms of the applicable manufacturer's warranty, the use of Customer Service is free. The minimum warranty period (manufacturer's warranty for private consumers) in the European Economic Area is 2 years according to the warranty terms applicable to the place. The warranty conditions do not affect any other rights or claims held by you under local law.

Detailed information about the warranty period and warranty conditions in your country are available from customer service, your dealer, or our website.

Original spare parts that function according to the relevant Eco-design Directive can be obtained from customer service for a period of at least 4 years from the date your device is placed on the market in the European Economic Area.

For more technical specifications on the repair agent and to order spare parts, please go to: [https:// www.schneiderconsumer.com](https://www.schneiderconsumer.com)

DISPOSAL



The European Directive 2012/19 / EU on Waste from Electrical equipment and Electronics (WEEE), requires that used household appliances not be thrown into the normal municipal waste stream. Used devices must be collected separately in order to optimize the recovery rate and recycling of the materials they are made of and reduce the impact on human health and the environment.

The crossed-out wheeled bin symbol is affixed to all products to remind you of the obligations of separate collection. Consumers should contact the local authorities or their dealer regarding the procedure to follow for the removal of their device.

Information on the meaning of the conformity mark 

The CE marking indicates that the product meets the main requirements of European Directives 2014/35 / EU (Low Voltage), 2014/30 / EU (Electromagnetic Compatibility), 2011/65 / EU (Reduction of the use of certain hazardous substances in EEE).

Imported by: SCHNEIDER CONSUMER GROUP
12 rue Jules Ferry - 93110 Rosny-Sous-Bois, FRANCE

SCHNEIDER