



Home Audio System

Operating Instructions

Getting started

Listening to a CD

Listening to the radio

Listening to a file on a USB device

Listening to music with optional audio components

Listening to music through a BLUETOOTH connection

Additional information

Troubleshooting

Precautions/Specifications

WARNING

To reduce the risk of fire, do not cover the ventilation opening of the appliance with newspapers, tablecloths, curtains, etc. Do not expose the appliance to naked flame sources (for example, lighted candles).

To reduce the risk of fire or electric shock, do not expose this appliance to dripping or splashing, and do not place objects filled with liquids, such as vases, on the appliance.

As the main plug is used to disconnect the unit from the mains, connect the unit to an easily accessible AC outlet. Should you notice an abnormality in the unit, disconnect the main plug from the AC outlet immediately.

Do not install the appliance in a confined space, such as a bookcase or built-in cabinet.

Do not expose batteries or appliances with battery-installed to excessive heat, such as sunshine and fire.

The unit is not disconnected from the mains as long as it is connected to the AC outlet, even if the unit itself has been turned off.

CAUTION

The use of optical instruments with this product will increase eye hazard.

For customers in Europe

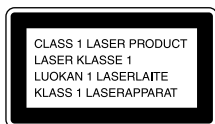

This appliance is classified as a CLASS 1 LASER product. This marking is located on the rear exterior.

Notice for customers: the following information is only applicable to equipment sold in countries applying EU directives.

This product has been manufactured by or on behalf of Sony Corporation, 1-7-1 Konan Minato-ku Tokyo, 108-0075 Japan. Inquiries related to product compliance based on European Union legislation shall be addressed to the authorized representative, Sony Belgium, bijkantoor van Sony Europe Limited, Da Vincilaan 7-D1, 1935 Zaventem, Belgium. For any service or guarantee matters, please refer to the addresses provided in the separate service or guarantee documents.

Hereby, Sony Corp., declares that this equipment is in compliance with the essential requirements and other relevant provisions of Directive 1999/5/EC. For details, please access the following URL: <http://www.compliance.sony.de/>



The validity of the CE marking is restricted to only those countries where it is legally enforced, mainly in the countries EEA (European Economic Area).

For customers in Europe and Australia

Disposal of waste batteries and electrical and electronic equipment (applicable in the European Union and other European countries with separate collection systems)



This symbol on the product, the battery or on the packaging indicates that the product and the battery shall not be treated as household waste.

On certain batteries this symbol might be used in combination with a

chemical symbol. The chemical symbols for mercury (Hg) or lead (Pb) are added if the battery contains more than 0.0005% mercury or 0.004% lead. By ensuring these products and batteries are disposed of correctly, you will help prevent potentially negative consequences for the environment and human health which could otherwise be caused by inappropriate waste handling. The recycling of the materials will help to conserve natural resources.

In case of products that for safety, performance or data integrity reasons require a permanent connection with an incorporated battery, this battery should be replaced by qualified service staff only. To ensure that the battery and the electrical and electronic equipment will be treated properly, hand over these products at end-of-life to the applicable collection point for the recycling of electrical and electronic equipment. For all other batteries, please view the section on how to remove the battery from the product safely. Hand the battery over to the applicable collection point for the recycling of waste batteries.

For more detailed information about recycling of this product or battery, please contact your local Civic Office, your household waste disposal service or the shop where you purchased the product or battery.

This system is designed to be used for the following purposes:

- Playing back music sources on discs or USB devices
- Listening to radio stations
- Playing back music sources on BLUETOOTH devices

Before operating this system

Malfunctions that occur during the normal use of the system will be repaired by Sony in accordance with the conditions defined in the limited warranty for this system. However, Sony will not be liable for any consequences arising from a failure to play caused by a damaged or malfunctioning system.

Music discs encoded with copyright protection technologies

This product is designed to playback discs that conform to the Compact Disc (CD) standard. Recently, various music discs encoded with copyright protection technologies are marketed by some record companies.

Please be aware that among those discs, there are some that do not conform to the CD standard and may not be playable by this product.

Note on DualDiscs

A DualDisc is a two sided disc product which mates DVD recorded material on one side with digital audio material on the other side. However, since the audio material side does not conform to the Compact Disc (CD) standard, playback on this product is not guaranteed.

Table of Contents

Before operating this system.....	3
-----------------------------------	---

Getting started

Location and function of controls.....	6
Preparing the remote control	10
Attaching the speaker pads.....	10
Setting the clock	10

Listening to a CD

Playing a CD-DA/MP3/WMA disc.....	12
To change the play mode	12
Creating your own program (Program Play).....	14

Listening to the radio

Tuning to a radio station	15
Presetting radio stations.....	15
Selecting a preset radio station.....	16

Listening to a file on a USB device

Playing a file on a USB device	17
To change the play mode	17

Listening to music with optional audio components

Using optional audio components	19
---------------------------------------	----

Listening to music through a BLUETOOTH connection

Pairing the system with a BLUETOOTH device and listening to music.....	20
Pairing with a device that does not have an NFC function	21
Pairing with a device that has an NFC function	22
Deleting pairing information	23
Pairing additional devices.....	24

Additional information

Setting the automatic standby function.....	25
Setting the BLUETOOTH standby mode.....	25
Setting the wireless BLUETOOTH signal on or off.....	26
Adjusting the sound	26
Using the timers.....	27
Setting the Sleep Timer	27
Setting the Play Timer	27
Changing the display.....	28

Troubleshooting

Troubleshooting	29
Messages	33

Precautions/Specifications

Precautions	34
Websites for compatible devices.....	35
BLUETOOTH wireless technology	36
Specifications.....	37

Location and function of controls

Note

This manual mainly explains operations using the remote control, but the same operations can also be performed using the buttons on the unit having the same or similar names.

Unit (front/top)

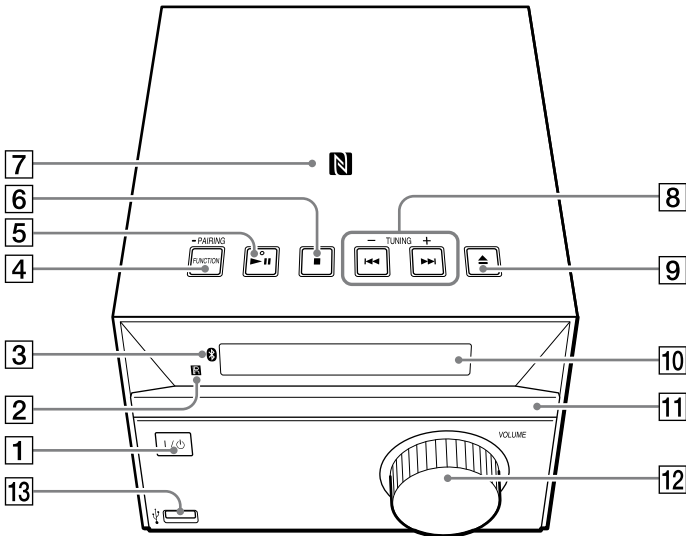

Remote control

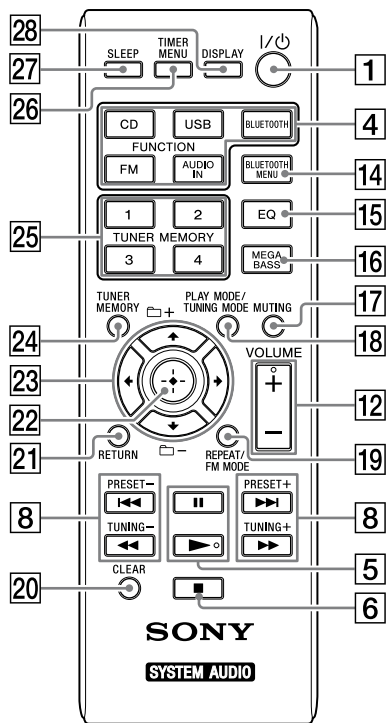

- 1** **I/⏻ (on/standby) button**
Use to turn on the system, or set it to standby mode.
- 2** **Remote control sensor**
- 3** **Ⓜ (BLUETOOTH) indicator**
Lights up or blinks to show the BLUETOOTH connection status.
- 4** **Unit: FUNCTION/PAIRING button**
 - Use to select the source. Each press changes to the next source in the following sequence:
CD → USB → BT AUDIO → FM → AUDIO IN
 - Press and hold to enter the BLUETOOTH pairing mode.

Remote control: FUNCTION buttons (CD, USB, BLUETOOTH, FM, AUDIO IN)
Use to select the source.

- 5** **Unit: ▶/⏸ (play/pause)* button**
Remote control: ▶ (play)* /⏸ (pause) button
Use to start or pause playback.
- 6** **■ (stop) button**
Use to stop a playback.
- 7** **N-Mark**
Place a smartphone/tablet equipped with the NFC function close to this mark to perform BLUETOOTH registration, connection or disconnection by a one touch action (page 22).
- 8** **⏮/⏭ (previous/next) buttons**
Use to select a track or file.
TUNING +/- buttons
Use to tune to a desired radio station.
Remote control: ⏮/⏭ (fast rewind/fast forward) buttons
Use to fast forward/fast rewind a track or file.
Remote control: PRESET +/- buttons
Use to recall the preset stations.
- 9** **⏏ (open/close) button**
Use to open and close the disc tray **11**.
- 10** **Display**
- 11** **Disc tray**
Use to load a disc (page 12).
- 12** **Unit: VOLUME control**
Remote control: VOLUME +/- button
Use to adjust the volume.
- 13** **🔌 (USB) port**
Use to connect a USB device (page 17).
- 14** **BLUETOOTH MENU button**
Use to open or close the BLUETOOTH menu (page 21, 24, 25).

15 EQ button

Use to select a sound effect (page 26).

16 MEGA BASS button

Use to boost bass sound (page 26).

17 MUTING button

Use to mute and unmute the sound.

18 PLAY MODE/TUNING MODE button

- Use to select the play mode (page 13).
- Use to select the tuning mode (page 15).

19 REPEAT/FM MODE button

- Use to select the repeat play mode (page 13).
- Use to select FM stereo or monaural reception (page 15).

20 CLEAR button

Use to delete a programmed track or file (page 14).

21 RETURN button

Use to return to the previous status.

22 ⊕ (enter) button

Use to confirm an item.

23 ←/↑/↓/→ buttons

Use to select an item.

 **+/- buttons**

Use to select a folder (album) on an MP3/WMA disc or USB device.

24 TUNER MEMORY button

Use to preset radio stations (page 15).

25 TUNER MEMORY number (1 to 4) buttons

Use to tune to 4 registered FM stations.

26 TIMER MENU button

Use to set the clock or Play Timer (page 10, 27).

27 SLEEP button

Use to set the Sleep Timer (page 27).

28 DISPLAY button

Use to change information displayed on the display **10** (page 28).

An underscore “_” is displayed in the place of an unrecognizable character.

If you press this button when the power is turned off, the clock time is displayed.

* The **▶||** button on the unit and **▶** and **VOLUME +** button on the remote control have a tactile dot. Use the tactile dot as a reference when operating the system.

Unit (back)

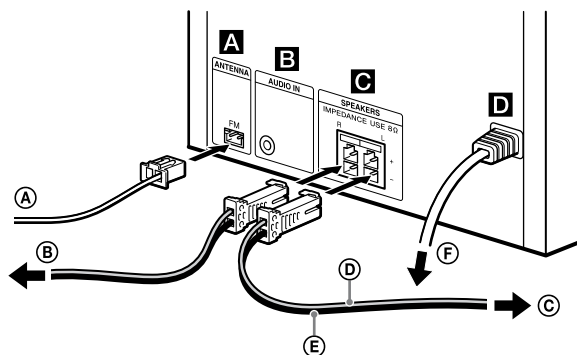

- Ⓐ FM lead antenna
- Ⓑ To right speaker
- Ⓒ To left speaker
- Ⓓ Speaker cord (Red/⊕)
- Ⓔ Speaker cord (Black/⊖)
- Ⓕ To wall outlet

Ⓐ FM antenna

Connect the FM antenna.

- Install the system in a location/orientation with good reception.

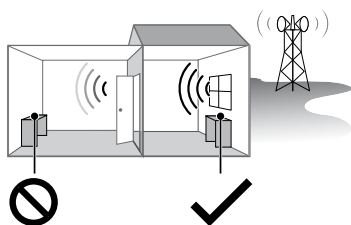

Areas with poor reception:
Far from windows, etc.

Areas with good reception:
Near windows, etc.

- Avoid the following kinds of locations.

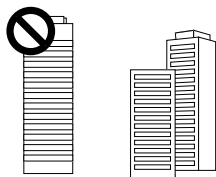

Between buildings



Nearby mobile phones, electrical appliances

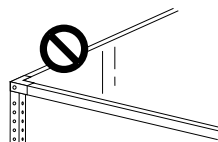

On steel desks or tables

- Secure the end of the FM antenna with a pin or tape, etc.

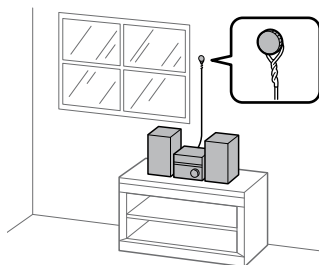

- Keep the antenna away from the speaker cords, the AC power cord and the USB cable to avoid picking up noise.
- Before unplugging the FM antenna, make sure the system is turned off to preserve your own FM settings.

Ⓑ Audio input jack

Connect optional external equipment with an audio connecting cable (not supplied).

Ⓒ Speakers

Connect the speakers.

Both left and right speakers are the same. You can connect both speakers to either of the speaker jacks regardless of the L and R indications above the jacks.

Ⓓ Power

Connect the power cord to the wall outlet.

Preparing the remote control

Insert an R6 (size AA) battery (not supplied), matching the polarities as shown below.

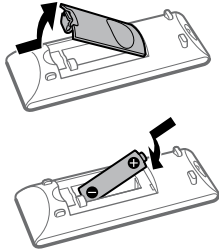

Notes on using the remote control

- With normal use, the battery should last for about six months.
- If you do not use the remote control for a long period of time, remove the battery to avoid damage from battery leakage and corrosion.

Attaching the speaker pads

Attach the supplied speaker pads at each corner on the bottom of the speakers to prevent them from slipping.

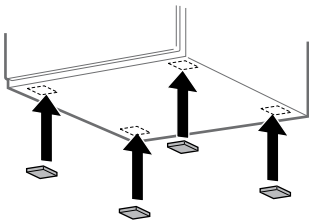

Setting the clock

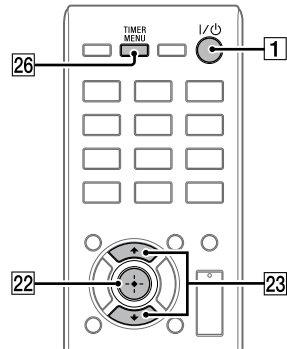

1 Press I/⏻ **1** to turn on the system.

2 Press TIMER MENU **26** to enter the clock set mode.

The hour indicator flashes on the display **10**.



If "SELECT" or "PLAY SET" appears, press **▲/▼ 23** to select "CLOCK," and then press **⊕ 22**.

3 Press **▲/▼ 23** to set the hour, then press **⊕ 22**.

The minute indicator flashes on the display **10**.



-
- 4 Press \uparrow/\downarrow $\boxed{23}$ to set the minutes, then press \oplus $\boxed{22}$.



Note

- The clock settings are reset when you disconnect the power cord or if a power failure occurs.

To display the clock when the system is off

Press DISPLAY $\boxed{28}$. The clock is displayed for about 8 seconds.

Listening to a CD

Playing a CD-DA/ MP3/WMA disc

- 1 Press **CD** [4].
- 2 Press **▲** [9] on the unit to open the disc tray [11] and place a disc on it.
Load a CD with the label side (printed side) facing up.

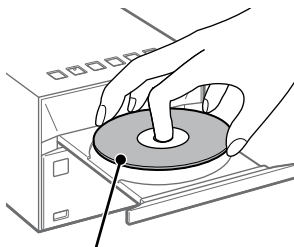

Label side (printed side)

- 3 Press **▲** [9] on the unit to close the disc tray [11].
- 4 Press **▶** [5].
Starts playback.

Other operations

To	Press
Pause playback	⏸ [5]. To resume play, press ▶ [5].
Stop playback	■ [6]. To resume play, press ▶ [5]*. To cancel resume play, press ■ [6] again.
Select a folder on an MP3/WMA disc	📁 +/ 📁 - [23] repeatedly.
Select a track or file	◀◀/▶▶ [8].
Find a point in a track or file	Hold down ◀◀/▶▶ [8] during playback, and release the button at the desired point.

* When playing a VBR MP3/WMA file, the system may resume playback from a different point.

To eject the CD

Press **▲** [9] on the unit.

Note

- Do not load a disc with a non-standard shape (e.g., heart, square, star). Doing so may cause irreparable damage to the system.
- Do not use a disc with tape or stickers on it as this may cause malfunction.
- When you remove a disc, do not touch its surface.

To change the play mode

Play mode enables you to playback the same music repeatedly or shuffle play.

- 1 Press **■** [6] to stop playback.

2 Press PLAY MODE **[18]** repeatedly to select a play mode.

You can select the following play modes.

Play mode	Effect
FLDR* (Folder)	Plays all files in the selected folder.
SHUF (Shuffle)	Plays all tracks or files in random order.
FLDRSHUF* (Folder shuffle)	Plays all files in the selected folder in random order.
PROGRAM (Program)	Plays the programmed tracks or files. For details, see "Creating your own program (Program Play)" (page 14).
OFF (Normal play)	Plays all tracks or files in sequential order.

* This play mode is applicable only for playing a USB device or MP3/WMA disc.

When "PLS STOP" appears

You cannot change the play mode during playback. Stop playback, then change the play mode.

To use the repeat play mode

To switch the repeat play mode, press REPEAT **[19]** repeatedly. Repeat play modes are selectable both while playback is stopped and during playback.

You can select the following play modes.

Play mode	Effect
REP ONE (Repeat one)	Plays a selected track or file repeatedly.
REP FLDR* (Repeat folder)	Plays all files in the selected folder repeatedly.
REP ALL (Repeat all)	Plays all tracks or files repeatedly.
REP OFF (Repeat off)	Turns off repeat play.

* This play mode is applicable only for playing a USB device or MP3/WMA disc.

Note

- Once the power cord is unplugged, the play mode is turned off automatically.

Note on playing MP3/WMA discs

- Do not save unnecessary folders or files on a disc that has MP3/WMA files.
- Folders that have no MP3/WMA files are not recognized on the system.
- The system can only play MP3/WMA files that have a file extension of ".mp3" or ".wma." Even when file name has the ".mp3" or ".wma" file extension, if it is not an audio MP3/WMA file, playing this file may generate a loud noise, which could cause damage of the system.
- The maximum number of folders and files that system can recognize is:
 - 256* folders (including the root folder)
 - 999 files
 - 999 files in a single folder
 - 8 folder levels (in the tree structure of files)
- * This includes folders that have no MP3/WMA or other files. The number of folders that the system can recognize may be less than actual number of folders, depending on the folder structure.
- Compatibility with all MP3/WMA encoding/writing software, CD-R/RW drive and recording media cannot be guaranteed. Incompatible MP3/WMA discs may produce noise or interrupted audio or may not play at all.

Note on playing multisession discs

The system can play back continuous sessions on a disc when they are recorded in the same session format as the first session. When a session recorded in a different session format is encountered, that session and the ones following it cannot be played back. Note that even if the sessions are recorded in the same format, some sessions may not play back.

Creating your own program (Program Play)

Plays the programmed track or file.

- 1 Press **■** **[6]** to stop playback.
- 2 Press PLAY MODE **[18]** repeatedly to select "PROGRAM."
- 3 When playing back an MP3/WMA disc, press **Ⓛ** +/- **[23]** to select the folder containing the tracks or files that you want to program.
- 4 Press **⏪/⏩** **[8]** to select a desired track or file, then press **⊕** **[22]**.



Selected track or file number

Total playing time of the selected track (CD-DA disc only)

For MP3/WMA file, the name or title of selected file appears on the display **[10]** first, and total playing time is not displayed.

- 5 Repeat step 4 (for CD-DA tracks) or step 3 through 4 (for MP3/WMA files) to program.
You can program up to a total of 64 tracks or files.

- 6 Press **▶** **[5]**.
Your program of tracks or files starts playback.

To cancel program play

Press PLAY MODE **[18]** repeatedly to select "OFF."

To delete a programmed track or file

Press CLEAR **[20]** while the play is stopped. Each time you press the button, the last programmed track or file will be deleted. When all the programmed tracks or files are deleted, "NO STEP" appears.

Tip

- To play the same program again, press **▶** **[5]**.

Note

- Up to 64 tracks or files can be programmed. If you attempt to program more than 64 tracks or files, "FULL" will be displayed.
- If you perform any of the following operations after programming, all the programmed tracks and files will be deleted.
 - Changing the function.
 - Turning off the system.
 - Disconnecting the power cord.
 - Opening the disc tray.

Tuning to a radio station

- 1 Press FM **[4]**.
- 2 Perform tuning.

For automatic scanning

Press TUNING MODE **[18]** repeatedly until "AUTO" appears, and then press TUNING +/- **[8]**. Scanning stops automatically when a station is tuned in.

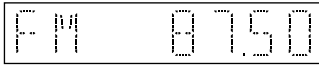

If the scanning for an FM station does not stop, press **[6]** to stop scanning, then perform manual tuning.

For manual tuning

Press TUNING MODE **[18]** repeatedly until "MANUAL" appears, and then press TUNING +/- **[8]** repeatedly to tune to the desired station. Each time you press TUNING +/- **[8]**, the frequency changes step by step. If you hold TUNING +/- **[8]** down, the frequency changes continuously until the button is released.

Tip

- When you tune to a station that provides RDS services, the service name or station name appears on the display (European model only).
- If reception of an FM stereo broadcast is noisy, press FM MODE **[19]** repeatedly to select "MONO" to select monaural reception. This reduces noise.

Presetting radio stations

You can preset your desired radio stations.

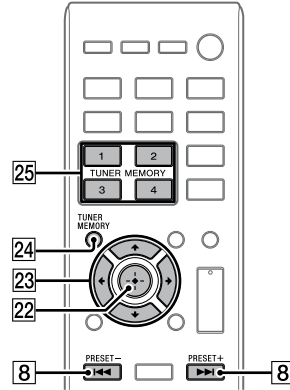

- 1 Tune to the desired station.
- 2 Press TUNER MEMORY **[24]**.
- 3 Press PRESET +/- **[8]** repeatedly to select a preset number, then press **[22]**.

You can also select a preset number by pressing TUNER MEMORY number (1 to 4) **[25]** or **[23]**.

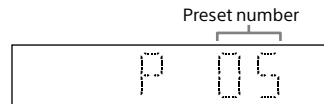

"COMPLETE" appears on the display **[10]** and the radio station is registered with the preset number.

Repeat the steps above to register further radio stations.

Tip

- You can preset up to 20 FM stations.
- If you select an already-registered preset number in step 3, the preset radio station is replaced by the currently tuned-in radio station.

Selecting a preset radio station

To select radio stations registered to a preset number from 1 to 4

- 1 Press FM **4**.
- 2 Press TUNER MEMORY number (1 to 4) **25**.

To select radio stations registered to a preset number of 5 or higher

- 1 Press FM **4**.
- 2 Press TUNING MODE **18** repeatedly to select "PRESET."
- 3 Press PRESET +/- **8** or **23** repeatedly to select the desired preset number.

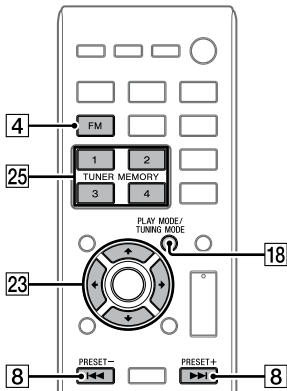

Playing a file on a USB device

You can play audio files stored on a USB device such as WALKMAN® or digital media player, on this system by connecting a USB device to the system.

For details on compatible USB devices, see “Websites for compatible devices” (page 35).

- 1 Press USB **[4]**.

- 2 Connect the USB device to the Ψ (USB) port **[13]** on the front of the unit.
 Connect the USB device directly, or via the USB cable supplied with the USB device, to the Ψ (USB) port **[13]**.
 Wait until “SEARCH” disappears.

- 3 Press **[▶]** **[5]**.
 Starts playback.

Other operations

To	Press
Pause playback	[⏸] [5] . To resume play, press [▶] [5] .
Stop playback	[■] [6] . To resume play, press [▶] [5] *. To cancel resume play, press [■] [6] again.
Select a folder	[📁 + / 📁 -] [23] repeatedly.
Select a file	[⏪ / ⏩] [8] .
Find a point in a track or file	Hold down [⏪ / ⏩] [8] during playback, and release the button at the desired point.

* When playing a VBR MP3/WMA file, the system may resume playback from a different point.

Note on removing a USB device

Be sure to turn off the system before removing the USB device. Removing the USB device while the system is turned on may corrupt the data on the USB device.

To use the system as a battery charger

USB devices that have a rechargeable battery can be charged with this system. Battery charging starts when the USB device is connected to the Ψ (USB) port **[13]** on the unit. If the device cannot be charged, try disconnecting and then reconnecting. For information on how to check the charging status, refer to the operating instructions of your USB device.

Notes on charging USB devices with this system

- You cannot use the system as a battery charger when the system is off.
- Battery charging may not be possible depending on the specifications of the USB device.

To change the play mode

You can change the play mode when the USB function is selected. For details, see “To change the play mode” (page 12).

Note

- The playback order for the system may differ from the playback order of the connected digital music player.
- When USB cable connection is necessary, connect the USB cable supplied with the USB device to be connected. For details on connection, refer to the operation manual supplied with the USB device to be connected.
- It may take time before “SEARCH” appears after connecting, depending on the type of USB device connected.
- Do not connect the USB device through a USB hub.
- When the USB device is connected, the system reads all the files on the USB device. If there are many folders or files on the USB device, it may take a long time to finish reading the USB device.
- With some connected devices, after an operation is performed, there may be a delay before it is performed by this system.

- Compatibility with all encoding/writing software cannot be guaranteed. If audio files on the USB device were originally encoded with incompatible software, those files may produce noise or may malfunction.
- The maximum number of folders and files that system can recognize is:
 - 256* folders (including the root folder)
 - 999 files
 - 999 files in a single folder
 - 8 folder levels (in the tree structure of files)
- * This includes folders that have no playable audio files and empty folders. The number of folders that the system can recognize may be less than actual number of folders, depending on the folder structure.
- The system does not necessarily support all the functions provided in a connected USB device.
- Folders that have no audio files are not recognized.
- The audio formats that you can listen to with this system are as follows:
 - MP3: file extension “.mp3”
 - WMA**: file extension “.wma”

Note that even when file name has the correct file extension, if the actual file differs, the system may produce noise or may malfunction.

- ** Files with DRM (Digital Rights Management) copyright protection or files downloaded from an online music store cannot be played on this system. If you try to play one of these files, the system plays the next unprotected audio file.

Using optional audio components

You can listen to sound from an optional audio component connected to the system.

Note

- Be sure to turn down the system volume by pressing VOLUME - [12] before starting playback to avoid sudden loud sound output from the speakers.

- 1 Press AUDIO IN [4].
- 2 Connect an optional audio component to the AUDIO IN jack [B] on the unit using an audio analog cord (not supplied).
- 3 Start playback of the connected component.
Adjust the volume on the connected component during playback.
- 4 Press VOLUME +/- [12] to adjust the volume.

Note

- The system may enter standby mode automatically if the volume level of the connected component is too low. For details, see "Setting the automatic standby function" (page 25).

Pairing the system with a BLUETOOTH device and listening to music

You can enjoy wireless playback of songs stored on a BLUETOOTH device. With devices that have an NFC function (smartphones, tablets, etc.), BLUETOOTH connection can be established easily by simply touching your device to the system.

Start with pairing!

When connecting BLUETOOTH devices, the two devices must register each other in advance. This is called "pairing." Pairing must be performed when you connect two devices for the first time. Once a device has been registered through pairing, it does not need to be paired again when connecting to that same device.

There are two methods of pairing: pairing using the NFC function, and pairing by manually activating the BLUETOOTH function. Choose the pairing method that matches your device.

■ Pairing with a device that does not have an NFC function (page 21)

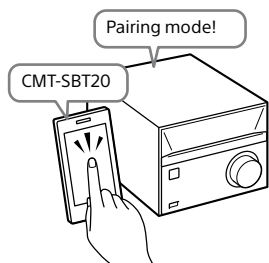

After setting the system to pairing mode, search for it on your BLUETOOTH device to start pairing.

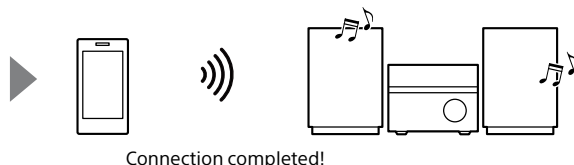

■ Pairing with a device that has an NFC function (page 22)

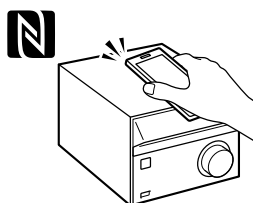

With a smartphone/tablet that has an NFC function, simply touch the device to the system. The system will turn on automatically and begin pairing.

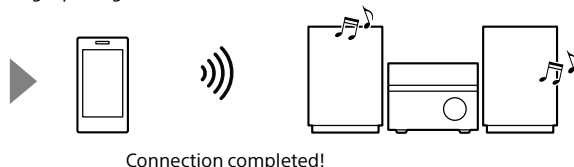



Pairing with a device that does not have an NFC function

Keep the BLUETOOTH device and the system within 1 meter of each other for this operation.

1 Press BLUETOOTH [4].

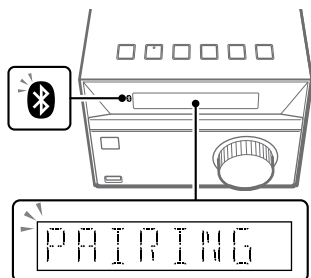
If there is no pairing information in the system, such as when using a BLUETOOTH device for the first time after purchasing the system, the system will automatically switch to pairing mode.



"PAIRING" flashes on the display [10] and the  (BLUETOOTH) indicator [3] flashes quickly.

2 Turn on (activate) the BLUETOOTH function on the BLUETOOTH device.

For details, refer to the operating instructions supplied with the BLUETOOTH device.

A list of the devices found may appear on the BLUETOOTH device display.

3 Select [CMT-SBT20] (this system).



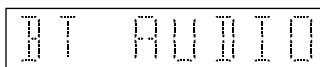

If you are prompted to enter a passkey, enter "0000." If the system does not show up on the list of devices, start over from step 1 again.

When pairing is completed, "BT AUDIO" will appear on the display [10] and the  (BLUETOOTH) indicator [3] will stop flashing.



4 Press [5].

Starts playback.

Using the buttons on the system or the remote control, you can control play/pause (/  [5]) and previous/next (/  [8]). Stopping playback and other operations can be controlled using the BLUETOOTH device.

5 Press VOLUME +/- [12] to adjust the volume.

Listening to music on a paired device

Press BLUETOOTH [4].



The last connected device will be connected automatically. If the connection cannot be established, make sure that the BLUETOOTH function on the BLUETOOTH device is activated, and then select the system ("CMT-SBT20") to start the connection process.

To cancel pairing

Press BLUETOOTH MENU [14], BLUETOOTH [4] or change the source.

Terminating a BLUETOOTH connection

1 Press BLUETOOTH MENU [14].

2 Press  [23] to select "DISCONNECT," then press  [22].

Note

- If playback does not start after pressing ► [5] in step 4 of "Pairing with a device that does not have an NFC function" (page 21), press ► [5] again or start the playback on the BLUETOOTH device.
- Operations may vary depending on your BLUETOOTH device.
- This system can be paired with up to 8 BLUETOOTH devices. If a new device is paired after 8 devices have been paired, pairing information of the device that was connected with the system first is overwritten with that of the new device.
- Once a pairing operation is performed, it does not have to be performed again. In the following cases, however, a pairing operation must be performed again:
 - Pairing information was deleted due to repair, etc.
 - Pairing registration information of this system is deleted on the BLUETOOTH device.
 - If you reset the system to factory settings (page 32), all the pairing information will be deleted.
- The sound of this system cannot be sent to a BLUETOOTH speaker.
- "Passkey" may be called "Passcode," "PIN code," "PIN number" or "Password," etc.
- You cannot make a BLUETOOTH connection with another BLUETOOTH device while the BLUETOOTH connection is established with one BLUETOOTH device. Terminate the connection first, and then connect with a new device.
- Sub Band Codec (SBC) is the only supported codec.

Pairing with a device that has an NFC function

Compatible smartphones are those equipped with the NFC function (compatible operating system: Android™ version 2.3.3 or later with the exception of Android 3.x). For details, see "Websites for compatible devices" (page 35).

What is "NFC"?

NFC (Near Field Communication) is a technology enabling short-range wireless communication between various devices, such as mobile phones and IC tags. Thanks to the NFC function, data communication can be achieved easily just by touching the relevant symbol or designated location on NFC compatible devices.

1 Turn on the NFC function of the smartphone/tablet.

For details, refer to the operating instructions supplied with the smartphone/tablet.

2 Touch the smartphone/tablet on the N-mark [7] on the unit.

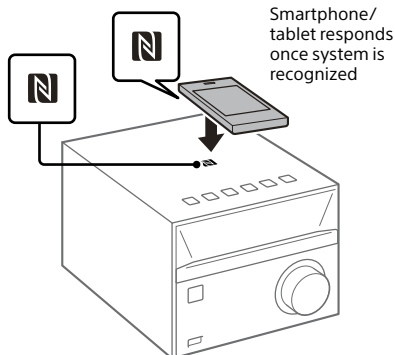

Follow the on-screen instructions to establish the connection. When the BLUETOOTH connection is established, "BT AUDIO" appears on the display [10].

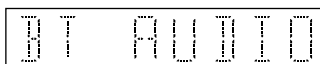

3 Press **▶** **[5]**.

Starts playback.

Using the buttons on the system or the remote control, you can control play/pause (**▶**/**||** **[5]**) and previous/next (**◀**/**▶** **[8]**). Stopping playback and other operations can be controlled using the BLUETOOTH device.

4 Press **VOLUME +/-** **[12]** to adjust the volume.**Listening to music on a paired device**

Press **BLUETOOTH** **[4]**.

The last connected device will be connected automatically. If the connection cannot be established, make sure that the BLUETOOTH function on the BLUETOOTH device is activated, and then select the system ("CMT-SBT20") to start the connection process.

Terminating a BLUETOOTH connection

Touch the device to the N-Mark **[7]** on the unit again.

Tip

- If the smartphone/tablet does not respond even though it is touched to the unit, download "NFC Easy Connect" to your smartphone/tablet and run it. Then touch to the unit again. "NFC Easy Connect" is a free application for exclusive use with Android. Scan the following 2D Code.



- If you touch an NFC-enabled smartphone/tablet to the system while it is already connected to a different BLUETOOTH device, the connection will switch over to the touched smartphone/tablet.
- If you touch a device to the N-Mark **[7]** while the system is reading data from a CD or USB device, the BLUETOOTH connection may fail. Touch the device to the system after reading is finished.

Note

- If playback does not start after pressing **▶** **[5]** in step 3 of "Pairing with a device that has an NFC function" (page 22), press **▶** **[5]** again or start the playback on the BLUETOOTH device.
- In some countries and regions, NFC-compliant application may not be downloaded.
- When using the NFC function, pairing, powering-on of the system, and establishment of BLUETOOTH connections are performed automatically by touching the device. However, when using the NFC function while the system is off, played back sound may not be audible from the beginning of the track. To restart playback from the beginning, press **◀** **[8]** to reselect the track, or turn off the system and then touch your smartphone/tablet to the N-mark **[7]** again after turning the system back on.

Deleting pairing information

To delete pairing information, the system must be reset to the factory settings through the following procedure.

- 1** Press and hold **FUNCTION** **[4]** and **▲** **[9]** on the unit at the same time until "RESET" appears on the display **[10]**.

Note

- If the pairing information for a paired device is deleted, you will be unable to use that device unless you perform pairing again.
- If the system is reset to the factory settings, all user-configured settings in addition to pairing information, such as preset radio stations, timer, and clock settings will be deleted.

Pairing additional devices

This system can pair with and store pairing information for up to 8 BLUETOOTH devices.

If the device does not have an NFC function:

- 1 Press BLUETOOTH MENU [14] and use ▲/▼ [23] to select "PAIRING", then press ⊕ [22].
- 2 Follow steps 2-3 in "Pairing with a device that does not have an NFC function" (page 21) to perform pairing.

To perform the pairing by using a button on the unit

- 1 Press FUNCTION [4] repeatedly to select "BT AUDIO."
- 2 Press and hold FUNCTION [4] until the  (BLUETOOTH) indicator [3] starts to flash quickly.
- 3 Follow steps 2-3 in "Pairing with a device that does not have an NFC function" (page 21) to perform pairing.

Tip

- To make a BLUETOOTH connection with a newly-paired device while the system is connected to a different device, first terminate the BLUETOOTH connection with the device currently being used, and then make the connection with the new device.

If the device has an NFC function:

Follow the procedure in "Pairing with a device that has an NFC function" (page 22) to perform pairing for the new device.

Setting the automatic standby function

The system enters standby mode automatically in about 15 minutes when there is no operation or audio signal output (automatic standby function).

By default, the automatic standby function is turned on.

- 1 Press I/⏻ **1** to turn on the system.
- 2 Press and hold I/⏻ **1** for more than 3 seconds.
- 3 After "AUTO STANDBY OFF" (automatic standby function is off) or "AUTO STANDBY ON" (automatic standby function is on) appears, release the buttons.

Tip

- When the system enters standby mode, "STANDBY" appears and blinks 8 times on the display **10**.

Note

- The system may not enter standby mode automatically in the following cases:
 - while using the tuner function
 - while an audio signal is being detected
 - during playback of audio tracks or files
 - while the Play Timer or Sleep Timer is being used
- The system resets the 15 minute countdown time for entering standby mode in the following cases:
 - when a USB device is connected in USB function
 - when a button on the remote or unit is pressed

Setting the BLUETOOTH standby mode

When BLUETOOTH standby mode is enabled, the system enters wait mode for BLUETOOTH connection even when the system is turned off. This mode is disabled by default.

- 1 Press BLUETOOTH MENU **14**.
- 2 Press \uparrow/\downarrow **23** to select "BT: STBY," then press \oplus **22**.
- 3 Press \uparrow/\downarrow **23** to select "ON" or "OFF," then press \oplus **22**.
- 4 Press I/⏻ **1** to turn off the system.
Once the system is off, the **8** (BLUETOOTH) indicator flashes slowly.

Tip

- When this mode is set to "ON," the system turns on automatically and you can listen to music by making a BLUETOOTH connection from a BLUETOOTH device.
- Disabling the BLUETOOTH standby mode reduces power consumption in standby mode.

Note

- When the system has no pairing information, this mode is not available. To use this mode, the system needs to be connected to the device and has its pairing information.

Setting the wireless BLUETOOTH signal on or off

When the system is turned on, you can control a BLUETOOTH signal. The BLUETOOTH signal is turned on by default.

- 1 Press I/⏻ [1] to turn on the system.
- 2 Press and hold ▶|| [5] and ◀◀ [8] on the unit at the same time for 5 seconds.
- 3 After "BT OFF" (wireless BLUETOOTH signal is off) or "BT ON" (wireless BLUETOOTH signal is on) appears, release the buttons.

Tip

- When this setting is set to "BT OFF", the BLUETOOTH function is not available.
- If the unit is touched with a smartphone/tablet with NFC function when this setting is off, the system is turned on and this setting changes to "BT ON".
- When this setting is off, the BLUETOOTH standby mode cannot be set.
- When this setting is off, the system and BLUETOOTH device cannot be paired.

Adjusting the sound

You can select the desired sound from the various styles and change the effectiveness of the bass sound.

Selecting the desired sound

Press EQ [15] repeatedly to select the desired sound from the following styles:

"R AND B/HIP HOP," "FLAT," "POP," "JAZZ," "ROCK," "CLASSIC."

Tip

- The default setting is "R AND B/HIP HOP."

Change the effectiveness of the bass sound

Press MEGA BASS [16].

Each press switches the feature on ("BASS ON") and off ("BASS OFF").

Tip

- The default setting is "BASS ON."

Using the timers

The system offers Sleep Timer and Play Timer.

Note

- The Sleep Timer has priority over the Play Timer.

Setting the Sleep Timer

At the specified time, the system is turned off automatically.

- 1 Press SLEEP **[27]** repeatedly to select the specified time.

You can select from "SLEEP 90" (90 minutes) to "SLEEP 10" (10 minutes), or "AUTO." Each time you press the button, the Sleep Timer decreases by 10 minutes. If you select "AUTO," the system turns off automatically after a CD or USB device playback ends, or within 100 minutes.

Tip

- To check the remaining time of Sleep Timer, press SLEEP **[27]** again.
- The Sleep Timer works even if the clock is not set.

To cancel the Sleep Timer

Press SLEEP **[27]** repeatedly to select "OFF."

Setting the Play Timer

You can listen to a CD, USB device or radio at a preset time.

Note

- Make sure you have set the clock before setting the timer (page 10).

- 1 Prepare the sound source, and then press VOLUME +/- **[12]** to adjust the volume.

- 2 Press TIMER MENU **[26]** to enter the timer set mode.

- 3 Press \uparrow/\downarrow **[23]** to select "PLAY SET," then press \oplus **[22]**.

"ON TIME" appears, and then the hour indicator flashes on the display **[10]**.



- 4 Press \uparrow/\downarrow **[23]** to set the hour, then press \oplus **[22]**.

The minute indicator flashes on the display **[10]**.

- 5 Press \uparrow/\downarrow **[23]** to set the minutes, then press \oplus **[22]**.

"OFF TIME" appears, and then the hour indicator flashes on the display **[10]**. Follow the same procedure to set the hour and minutes for stop time of the Play Timer.

- 6 Press \uparrow/\downarrow **[23]** to select the desired sound source, then press \oplus **[22]**.

The confirmation display for the Play Timer appears.

- 7 Press I/⏻ **[1]** to turn off the system.

Tip

- When the sound source is a radio, make sure to tune in to the radio station before turning off the system (page 15).
- To change the timer setting, perform the procedures from the beginning again.
- The Play Timer setting remains as long as the setting is not cancelled manually.

Note

- The system turns on exactly at the time set in Play Timer. When the sound source is a CD, MP3/WMA disc or USB, it may take some time to start playback.
- The Play Timer does not work if the system is already on at the preset time.
- When the sound source for a Play Timer is set to a radio station, the last tuned frequency is used for a Play Timer. If you change the radio frequency after setting the timer, the radio station setting for the timer will also be changed.

To check the setting

- 1 Press TIMER MENU **[26]**.
- 2 Press **▲/▼ [23]** to select "SELECT," then press **⊕ [22]**.
- 3 Press **▲/▼ [23]** to select "PLAY SEL," then press **⊕ [22]**.
The timer setting appears on the display **[10]**.

To cancel the timer

- 1 Press TIMER MENU **[26]**.
- 2 Press **▲/▼ [23]** to select "SELECT," then press **⊕ [22]**.
- 3 Press **▲/▼ [23]** to select "OFF," then press **⊕ [22]**.

Changing the display

To	Press
Change information on the display*	DISPLAY [28] repeatedly when the system is on.
Check the clock when the system is off	DISPLAY [28] when the system is off. The clock is displayed for 8 seconds.

* For example, you can view CD-DA/MP3/WMA disc information or USB device information such as track number, file/folder name, album name, artist name, and remaining playing time.

Notes on the display information

- Characters that cannot be displayed appear as "-".
- The following are not displayed;
 - total playing time for an MP3/WMA disc and a USB device.
 - remaining playing time for an MP3/WMA file.
 - WMA tag information (song title/album name/artist name)
- The following are not displayed correctly;
 - elapsed playing time of an MP3/WMA file encoded using VBR (variable bit rate).
 - folder and file names that do not follow either the ISO9660 Level 1, Level 2 or Joliet in the expansion format.
- The following are displayed;
 - remaining playing time for a track.
 - ID3 tag information for MP3 files when ID3 version 1 and version 2 tags are used (ID3 version 2 tag information display has priority when both ID3 version 1 and version 2 tags are used for a single MP3 file).
 - up to 64 characters of ID3 tag information using uppercase letters (A to Z), numbers (0 to 9), and symbols (< > +, [] \ _).

Troubleshooting

If a problem occurs while operating the system, follow the steps described below before consulting your nearest Sony dealer. If an error message appears, be sure to make a note of the contents for reference.

- 1 Check to see if the problem is listed in this "Troubleshooting" section.
- 2 Check the following customer support websites.

For customers in Europe:

<http://www.sony.eu/support>

For customers in Latin America:

<http://esupport.sony.com/LA>

**For customers in other countries/
regions:**

<http://www.sony-asia.com/support>

You will find the latest support information and a FAQ at these websites.

- 3 If, after steps 1 and 2, you still cannot solve the problem, consult your nearest Sony dealer. When bringing the product in for repairs, be sure to bring in the entire system (main unit, speakers and remote control). This product is a system product, and the entire system is needed to determine the section requiring repair.

If "PROTECT" appears on the display 10

Immediately unplug the power cord, and check the following items after "PROTECT" disappears.

- Make sure that the + and - speaker cords are not short circuited.
- Make sure that nothing is blocking the ventilation holes of the system.

After you have checked these above items and found no problems, reconnect the power cord, and turn on the system. If the issue persists, contact your nearest Sony dealer.

General

The system does not turn on.

- ➔ Make sure you have connected the power cord to a wall outlet correctly.

The system has entered standby mode unexpectedly.

- ➔ This is not a malfunction. The system enters standby mode automatically in about 15 minutes when there is no operation or audio signal output. See "Setting the automatic standby function" (page 25).

The clock setting or the Play Timer operation has been canceled unexpectedly.

- ➔ If about a minute elapses with no operation, the clock setting or Play Timer setting is canceled automatically. Perform the operation again from the beginning.

There is no sound.

- ➔ Are the + and - speaker cords short-circuited?
- ➔ Are you using only the supplied speakers?
- ➔ Is anything blocking the ventilation holes of the system?
- ➔ Turn up the volume on the unit.
- ➔ Make sure an external component is connected correctly to the AUDIO IN jack B and set the function to AUDIO IN.
- ➔ The specified station may have temporarily stopped broadcast.

Sound comes from one channel, or the left and right volumes are unbalanced.

- ➔ Place the speakers as symmetrically as possible.
- ➔ Connect only the supplied speakers.

Severe hum or noise occurs.

- ➔ Move the system away from sources of noise.
- ➔ Connect the system to a different wall outlet.
- ➔ Use of an AC power tap with a noise filter (not supplied) is recommended.

The remote control does not function.

- ➔ Remove any obstacles between the remote control and the remote control sensor [2] on the unit, and position the unit away from fluorescent lights.
- ➔ Point the remote control at the remote control sensor [2] on the unit.
- ➔ Move the remote control closer to the system.
- ➔ Replace the battery with a new one.

Disc player

The disc or file will not play.

- ➔ The disc has not been finalized (a CD-R or CD-RW disc to which data can be added).

The sound skips, or the disc will not play.

- ➔ The disc may be dirty or scratched. When the disc is dirty, wipe it clean.
- ➔ Move the system to a location away from vibration (for example, on top of a stable stand).
- ➔ Move the speakers away from the system, or place them on separate stands. At high volume, speaker vibration may cause the sound to skip.

Play does not start from the first track or file.

- ➔ Set the play mode to "OFF" (normal play mode) (page 12).

Starting playback takes more time than usual.

- ➔ The following discs can increase the time it takes to start playback:
 - a disc recorded with a complicated tree structure
 - a disc recorded in multisession format
 - a disc that has many folders

USB device

For details on compatible USB devices, see "Websites for compatible devices" (page 35).

An unsupported USB device is connected.

- ➔ The following problems may occur.
 - The USB device is not recognized.
 - File or folder names are not displayed on this system.
 - Playback is not possible.
 - The sound skips.
 - There is noise.
 - A distorted sound is output.

There is no sound.

- ➔ The USB device is not connected correctly. Turn off the system, and then reconnect the USB device.

There is noise, skipping, or distorted sound.

- ➔ An unsupported USB device is connected. Connect a supported USB device.
- ➔ Turn off the system, then reconnect the USB device and turn on the system.
- ➔ The music data itself contains noise, or the sound is distorted. Noise may have been entered when creating music data due to the conditions of the computer. Create the music data again.
- ➔ The bit rate used when encoding the files was low. Send files encoded with higher bit rates to the USB device.

"SEARCH" is displayed for an extended time, or it takes a long time before playback starts.

- ➔ The reading process may take a long time in the following cases.
 - There are many folders or files on the USB device.
 - The file structure is extremely complex.
 - Not enough free space in the memory.
 - The internal memory is fragmented.

The file or folder name (album name) is not displayed correctly.

- ➔ The character code that can be displayed by this system are as follows:
 - Upper cases (A to Z).
 - Numbers (0 to 9).
 - Symbols (< > +, [] \ _).
 Other characters appear as “_”.

The USB device is not recognized.

- ➔ Turn off the system and reconnect the USB device, then turn on the system.
- ➔ An incompatible USB device may be connected.
- ➔ The USB device does not work properly. Refer to the operating manual supplied with the USB device for how to deal with this problem.

“OVER CURRENT” appears.

- ➔ A problem has been detected with the level of electrical current from the Ψ (USB) port [13]. Turn off the system and remove the USB device from the Ψ (USB) port [13]. Make sure there is no problem with the USB device. If this display pattern persists, contact your nearest Sony dealer.

Play does not start.

- ➔ Turn off the system and reconnect the USB device, then turn on the system.
- ➔ An incompatible USB device may be connected.

Play does not start from the first file.

- ➔ Set the play mode to “OFF” (normal play mode) (page 12).

The USB device cannot be charged.

- ➔ Make sure the USB device is connected securely to the Ψ (USB) port [13].
- ➔ The USB device may not be supported by this system.
- ➔ Battery charging may not be possible depending on the specifications of the USB device.
- ➔ Disconnect the USB device and then reconnect it. For details on the charging status of the USB device, see the operating manual of the USB device.

Files cannot be played back.

- ➔ The audio files may have inappropriate file extensions. The file extensions supported by this system are as follows:
 - MP3: file extension “.mp3”
 - WMA: file extension “.wma”
 - ➔ The audio files may have been created in formats other than MP3/WMA formats.
 - ➔ USB storage devices formatted with file systems other than FAT16 or FAT32 are unsupported.*
 - ➔ If you use a partitioned USB storage device, only files on the first partition can be played.
 - ➔ Files that are encrypted or protected by passwords, etc. cannot be played back.
- * This system supports FAT16 and FAT32, but some USB storage devices may not support all of these FAT. For details, see the operation manual of each USB storage device or contact the manufacturer.

Tuner

Severe hum or noise occurs, or broadcasts cannot be received.

- ➔ Connect the antenna properly.
- ➔ Find a location and an orientation that provide good reception, and then set up the antenna again (page 9).
- ➔ Keep the antennas away from the unit or other AV components to avoid picking up noise.
- ➔ Turn off nearby electrical equipment.

Several radio stations can be heard at the same time.

- ➔ Find a location and an orientation that provide good reception, and then set up the antenna again (page 9).
- ➔ Bundle the antenna cables using commercially available cord clips and adjust the cable lengths.

BLUETOOTH device

Pairing cannot be performed.

- ➔ Move the BLUETOOTH device closer to the system.
- ➔ Pairing may not be possible if other BLUETOOTH devices are present around the system. In this case, turn off the other BLUETOOTH devices.
- ➔ Make sure to enter the correct passkey when selecting the model number (this system) on the BLUETOOTH device (page 21).

Connection is not possible.

- ➔ The BLUETOOTH device you attempted to connect does not support the A2DP profile, and cannot be connected with the system.
- ➔ Enable the BLUETOOTH function of the BLUETOOTH device.
- ➔ Establish a connection from the BLUETOOTH device.
- ➔ The pairing registration information has been deleted. Perform the pairing operation again.
- ➔ Delete the pairing registration information of the BLUETOOTH device (page 23) and perform the pairing operation again (page 20).

The sound skips or fluctuates, or the connection is lost.

- ➔ The system and the BLUETOOTH device are too far apart.
- ➔ If there are obstacles between the system and your BLUETOOTH device, remove or avoid the obstacles.
- ➔ If there is equipment that generates electromagnetic radiation, such as a wireless LAN, other BLUETOOTH device, or a microwave oven nearby, move them away.

The sound of your BLUETOOTH device cannot be heard on this system.

- ➔ Increase the volume on your BLUETOOTH device first, then adjust the volume using VOLUME +/- [12].

There is severe hum, noise or distorted sound.

- ➔ If there are obstacles between the system and your BLUETOOTH device, remove or avoid the obstacles.
- ➔ If there is equipment that generates electromagnetic radiation, such as a wireless LAN, other BLUETOOTH device, or a microwave oven nearby, move them away.
- ➔ Turn down the volume of the connected BLUETOOTH device.

To reset the system to factory settings

If the system still does not operate properly, reset the system to factory settings.

- 1 Press I/⏻ [1] to turn on the system.
- 2 Press and hold FUNCTION [4] and ▲ [9] on the unit at the same time until "RESET" appears on the display [10].

All user-configured settings, such as preset radio stations, timer, the clock, and the pairing information of BLUETOOTH devices are deleted. If the problem persists after doing all of the above, consult your nearest Sony dealer.

Note

- If you dispose of the unit or give it to another person, reset the unit for security.

Messages

The following messages may appear or flash during operation.

COMPLETE

The station preset operation ended normally.

DISC ERR

You have set a disc that cannot be played back on this system, such as CD-ROM, or tried to play an unplayable file.

FULL

You tried to program more than 64 tracks or files.

NO DISC

There is no disc in the player, or you have set a disc that cannot be loaded.

NO FILE

There are not playable files on the USB device or disc.

NO STEP

There is no programmed track or file for program play or all of the programmed tracks or files have been erased.

NO USB

No USB device is connected, the connected USB device has been removed, or the system does not support the USB device.

OVER CURRENT

The system detects an over current in a connected USB device. Remove the USB device from the port and turn off the system then turn on the system.

PLS STOP

You attempted to change the play mode during playback in the CD or USB function.

READING

The system is reading the information on the CD. Some buttons do not work during reading.

SEARCH

The system is searching the information on the USB device. Some buttons do not work during searching.

TIME NG

The Play Timer start and end times are set to the same time.

TUNING

The system is tuning to a radio station. Some buttons do not work during tuning.

Precautions

Discs that this system CAN play

- Audio CD
- CD-R/CD-RW (audio data of CD-DA tracks and MP3/WMA files)
- 8 cm disc

Do not use a CD-R/CD-RW disc with no data stored. Doing so may damage the disc.

Discs that this system CANNOT play

- CD-ROM
- CD-R/CD-RW other than those recorded in music CD format, conforming to ISO9660 Level 1/Level 2 or Joliet
- CD-R/CD-RW recorded in multisession that have not ended by "closing the session"
- CD-R/CD-RW of poor recording quality, CD-R/CD-RW that have scratches or are dirty, or CD-R/CD-RW recorded with an incompatible recording device
- CD-R/CD-RW which is finalized incorrectly
- Discs containing files other than MPEG 1 Audio Layer-3 (MP3)/WMA files
- Discs of non-standard shape (for example, heart, square, star)
- Discs that have adhesive tape, paper, or sticker attached to them
- Rental or used discs with attached seals where the glue extends beyond the seal
- Discs that have labels printed using ink that feels tacky when touched

Note on CD-DA/MP3/WMA discs

- Before playing, wipe the disc with a cleaning cloth from the center out to the edge.
- Do not clean discs with solvents, such as benzine, thinner, or commercially available cleaners or antistatic spray intended for vinyl LPs.
- Do not expose discs to direct sunlight or heat sources such as hot air ducts, nor leave them in a car parked in direct sunlight.

On safety

- Completely disconnect the power cord (mains lead) from the wall outlet (mains) if it is not going to be used for an extended period of time. When unplugging the system, always grip the plug. Never pull the cord itself.
- Should any solid object or liquid get into the system, unplug the system, and have it checked by qualified personnel before operating it again.
- The AC power cord can be changed only by a qualified service facility.

On placement

- Do not place the system in an inclined position or in locations that are extremely hot, cold, dusty, dirty, or humid or lacking adequate ventilation, or subject to vibration, direct sunlight or a bright light.
- Do not place the system near lighting fixtures. The heat from the lighting may deform the enclosure and cause the system to malfunction.
- Be careful when placing the system on surfaces that have been specially treated (for example, with wax, oil, polish) as staining or discoloration of the surface may result.
- Do not place heavy objects on the system.
- If the system is brought directly from a cold to a warm location or is placed in a very damp room, moisture may condense on the lens inside the system, and cause the system to malfunction. In this situation, remove the disc, and leave the system turned on for about an hour until the moisture evaporates. If the system still does not operate, even after an extended period, consult your nearest Sony dealer.

On heat buildup

- Heat buildup on the unit during charging or operation over a long period of time is normal and not cause for alarm.
- Do not touch the cabinet if it has been used continuously at a high volume because the cabinet may have become hot.
- Do not obstruct the ventilation holes.

On the speaker system

This speaker system is not magnetically shielded, and the picture on nearby TV sets may become magnetically distorted. In this situation, turn off the TV, wait 15 to 30 minutes, and turn it back on. If there is no improvement, move the speakers far away from the TV.

Cleaning the cabinet

Clean this system with a soft cloth slightly moistened with a mild detergent solution. Do not use any type of abrasive pads, scouring powder, or solvents, such as thinner, benzine, or alcohol.

On moving the system

Before moving the system, make sure that there is no disc loaded, and remove the power cord from the wall outlet.

On handling discs

- To keep the disc clean, handle the disc by its edge. Do not touch the surface.
- Do not attach paper or tape to the disc.
- Do not expose discs to direct sunlight or heat sources such as hot air ducts, or leave them in a car parked in direct sunlight, as the temperature may rise considerably inside the car.

Websites for compatible devices

Check the websites below for the latest information about compatible USB and BLUETOOTH devices.

For customers in Europe:

<http://www.sony.eu/support>

For customers in Latin America:

<http://esupport.sony.com/LA>

For customers in other countries/regions:

<http://www.sony-asia.com/support>

BLUETOOTH wireless technology

BLUETOOTH wireless technology is a short-range wireless technology that enables wireless data communication between digital devices, such as a computer and digital camera. BLUETOOTH wireless technology operates within a range of about 10 m.

Connecting two devices as necessary is common, but some devices can be connected to multiple devices at the same time.

You do not need to use a cable for connection, nor is it necessary for the devices to face one another, such is the case with infrared technology. For example, you can use such a device in a bag or pocket. BLUETOOTH standard is an international standard supported by thousands of companies all over the world, and employed by various companies worldwide.

Supported BLUETOOTH version and profiles

Profile refers to a standard set of capabilities for various BLUETOOTH product capabilities. See “Specifications” (page 37) for details on the supported BLUETOOTH version and profiles.

Note

- To use a BLUETOOTH device connected to this system, the device must support the same profile as this system. Note that the functions of the BLUETOOTH device may be different depending on the specifications of the device, even if it has the same profile as this system.
- Because of the properties of BLUETOOTH wireless technology, playback on this system is slightly delayed compared with audio playback on the transmitting device.

Effective communication range

BLUETOOTH devices should be used within approximately 10 meters (unobstructed distance) of each other.

The effective communication range may become shorter under the following conditions.

- When a person, metal object, wall or other obstruction is between the devices with a BLUETOOTH connection
- Locations where a wireless LAN is installed
- Around microwave ovens that are in use
- Locations where other electromagnetic waves occur

Interference from other devices

BLUETOOTH devices and wireless LAN (IEEE802.11b/g) use the same frequency band (2.4 GHz). When using your BLUETOOTH device near a device with wireless LAN capability, electromagnetic interference may occur.

This could result in lower data transfer rates, noise, or inability to connect. If this happens, try the following remedies:

- Try connecting this system and BLUETOOTH device when you are at least 10 meters away from the wireless LAN equipment.
- Turn off the power to the wireless LAN equipment when using your BLUETOOTH device within 10 meters

Interference to other devices

The radio waves broadcast by this system may interfere with the operation of some medical devices. Since this interference may result in malfunction, always turn off the power on this system and BLUETOOTH device in the following locations:

- In hospitals, on trains, and in airplanes
- Near automatic doors or fire alarms

Note

- This system supports security functions that comply with the BLUETOOTH specification as a means of ensuring security during communication using BLUETOOTH technology. However, this security may be insufficient depending on the setting contents and other factors, so always be careful when performing communication using BLUETOOTH technology.
- Sony cannot be held liable in any way for damages or other loss resulting from information leaks during communication using BLUETOOTH technology.
- BLUETOOTH communication is not necessarily guaranteed with all BLUETOOTH devices that have the same profile as this system.
- BLUETOOTH devices connected with this system must comply with the BLUETOOTH specification prescribed by the Bluetooth SIG, Inc., and must be certified to comply. However, even when a device complies with the BLUETOOTH specification, there may be cases where the characteristics or specifications of the BLUETOOTH device make it impossible to connect, or may result in different control methods, display or operation.
- Noise may occur or the audio may cut off depending on the BLUETOOTH device connected with this system, the communications environment, or surrounding conditions.

Specifications

Amplifier section

Power output (rated):

5.2 watts + 5.2 watts (at 8 ohms, 1 kHz, 1% THD)

RMS power output (reference):

6 watts + 6 watts (per channel at 8 ohms, 1 kHz)

Inputs/Outputs

AUDIO IN:

AUDIO IN (external input) jack:
Stereo mini jack, sensitivity 1 V, impedance 12 kilohms

USB:

USB port: Type A, 5 V DC 500 mA

SPEAKERS:

Accepts impedance of 8 ohms

CD-DA/MP3/WMA player section

System:

Compact disc and digital audio system

Laser Diode Properties:

Emission Duration: Continuous
Laser Output*: Less than 44.6 μ W

* This output is the value measurement at a distance of 200 mm from the objective lens surface on the Optical Pick-up Block with 7 mm aperture.

Frequency response:

20 Hz - 20 kHz

Signal-to-noise ratio:

More than 90 dB

Dynamic range:

More than 90 dB

Tuner section

FM stereo, FM superheterodyne tuner

Antenna:

FM lead antenna

Tuning range:

87.5 MHz - 108.0 MHz (50 kHz step)

BLUETOOTH section

Communication system:

BLUETOOTH Standard version 4.0

Output:

BLUETOOTH Standard Power Class 2

Maximum communication range:

Line of sight approx. 10 m*1

Frequency band:

2.4 GHz band (2.4000 GHz - 2.4835 GHz)

Modulation method:

FHSS

Compatible BLUETOOTH profiles*2:

A2DP (Advanced Audio Distribution Profile)
AVRCP (Audio Video Remote Control Profile)

Supported content protection method

SCMS-T method

Supported codec

SBC (Sub Band Codec)

Transmission bandwidth

20 Hz - 20,000 Hz (with 44.1 kHz sampling)

*1 The actual range will vary depending on factors such as obstacles between devices, magnetic fields around a microwave oven, static electricity, reception sensitivity, antenna's performance, operating system, software application, etc.

*2 BLUETOOTH standard profiles indicate the purpose of BLUETOOTH communication between devices.

Speaker section

Speaker system:

Full range, 8 cm dia., cone type

Rated impedance:

8 ohms

Dimensions (W/H/D):

Approx. 148 mm × 240 mm × 127 mm

Mass:

Approx. 1.2 kg net per speaker

Quantity:

2 pieces

General

Power requirements:

Korean model: AC 220 V – 240 V, 50/60 Hz
Other models: AC 120 V – 240 V, 50/60 Hz

Power consumption:

24 watts

Dimensions (W/H/D) (incl. projecting parts):

Approx. 170 mm × 133 mm × 222 mm

Mass:

Approx. 1.3 kg

Supplied accessories:

Remote control (RM-AMU212) (1), FM lead antenna (1), Speaker pads (8), AC plug adaptor (1) (Latin American models only, except for Argentine and Mexican models), Operating Instructions (this manual) (1)

Storage conditions:

Products should be stored in the carton in the dark, dry, clean well ventilated premises isolated from places of storage of acids and alkalis.

Storage temperature: -10°C to +45°C

Storage humidity: 30% to 70%

Operating temperature: 5°C to 35°C

Operating humidity: 30% to 70%

Design and specifications are subject to change without notice.

Standby power consumption:

When BLUETOOTH standby mode is set to off:

0.3 W

When BLUETOOTH standby mode is set to on:

2.5 W

Trademarks, etc.

- Windows Media is either a registered trademark or trademark of Microsoft Corporation in the United States and/or other countries.
- This product is protected by certain intellectual property rights of Microsoft Corporation. Use or distribution of such technology outside of this product is prohibited without a license from Microsoft or an authorized Microsoft subsidiary.
- MPEG Layer-3 audio coding technology and patents licensed from Fraunhofer IIS and Thomson.
- "WALKMAN" and "WALKMAN" logo are registered trademarks of Sony Corporation.
- The BLUETOOTH® word mark and logos are registered trademarks owned by Bluetooth SIG, Inc. and any use of such marks by Sony Corporation is under license.
- The N Mark is a trademark or registered trademark of NFC Forum, Inc. in the United States and in other countries.
- Android™ is a trademark of Google Inc.
- The system names and product names indicated in this manual are generally the trademarks or registered trademarks of the manufacturer.
™ and ® marks are omitted in this manual.

<http://www.sony.net/>



* 4 5 8 3 7 4 6 1 1 * (2)