

RAZER™
RAIJU



When it comes to console gaming, your controller is the most crucial weapon in your arsenal. Every component of the Razer Raiju for PlayStation®4 has been optimized to give you every possible competitive advantage—from four additional fully-programmable buttons, to the weight and shape of the controller, and even a Quick Control Panel. Made from incredibly durable materials and extensively tested by esports athletes, dominate your game with this unrivalled controller.

TABLE OF CONTENTS

1. PACKAGE CONTENTS / SYSTEM REQUIREMENTS	3
2. REGISTRATION / TECHNICAL SUPPORT.....	4
3. DEVICE LAYOUT.....	5
4. SETTING UP YOUR RAZER RAIJU	7
5. ADDITIONAL ACCESSORIES	10
6. USING YOUR RAZER RAIJU	11
7. SAFETY AND MAINTENANCE	18
8. LEGALESE	19

1. PACKAGE CONTENTS / SYSTEM REQUIREMENTS

PACKAGE CONTENTS

- Razer Raiju Gaming Controller for PS4®
- Carrying case
- Screwdriver
- Detachable braided fiber cable
- 2 analog stick rubber grip caps
- Important Product Information Guide

SYSTEM REQUIREMENTS

- PlayStation®4 / PC (Windows 7 and above)
- A free USB port

2. REGISTRATION / TECHNICAL SUPPORT

REGISTRATION

Visit razerzone.com/razer-id to sign up for a Razer ID now to get a wide range of Razer benefits. For example, get real-time information on your product's warranty status via Razer Synapse. To learn more about Razer Synapse and all its features, visit razerzone.com/synapse.

If you already have a Razer ID, register your product by clicking on your email address within the Razer Synapse application and select *Warranty Status* from the dropdown list.

To register your product online, visit razerzone.com/registration. Please note that you will not be able to view your warranty status if you register via the website.

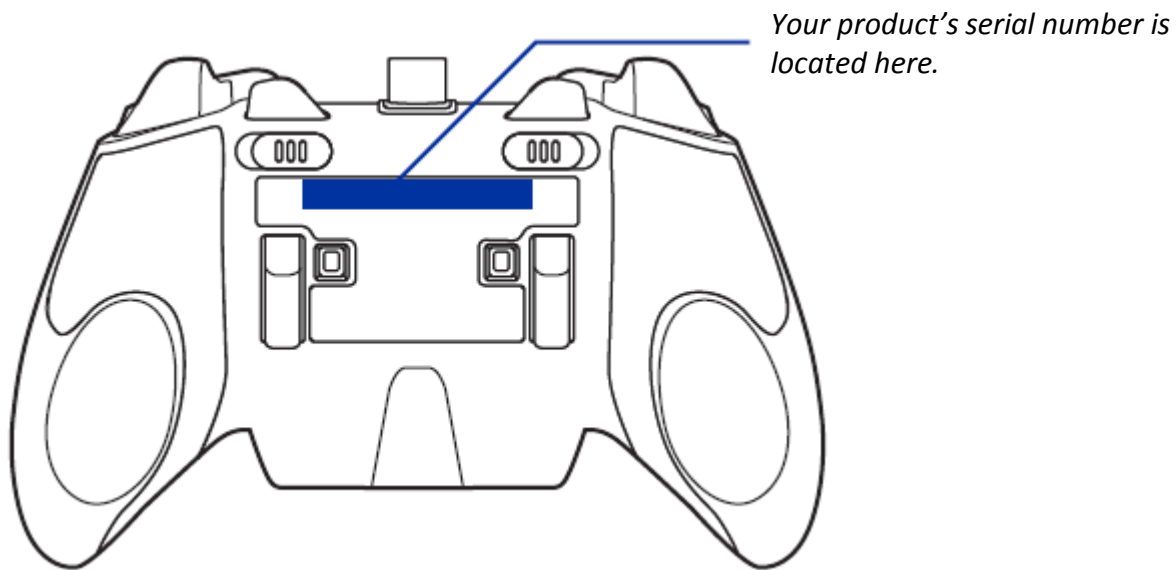

TECHNICAL SUPPORT

What you'll get:

- 1 year limited manufacturer's warranty.
- Free online technical support at razersupport.com.

3. DEVICE LAYOUT

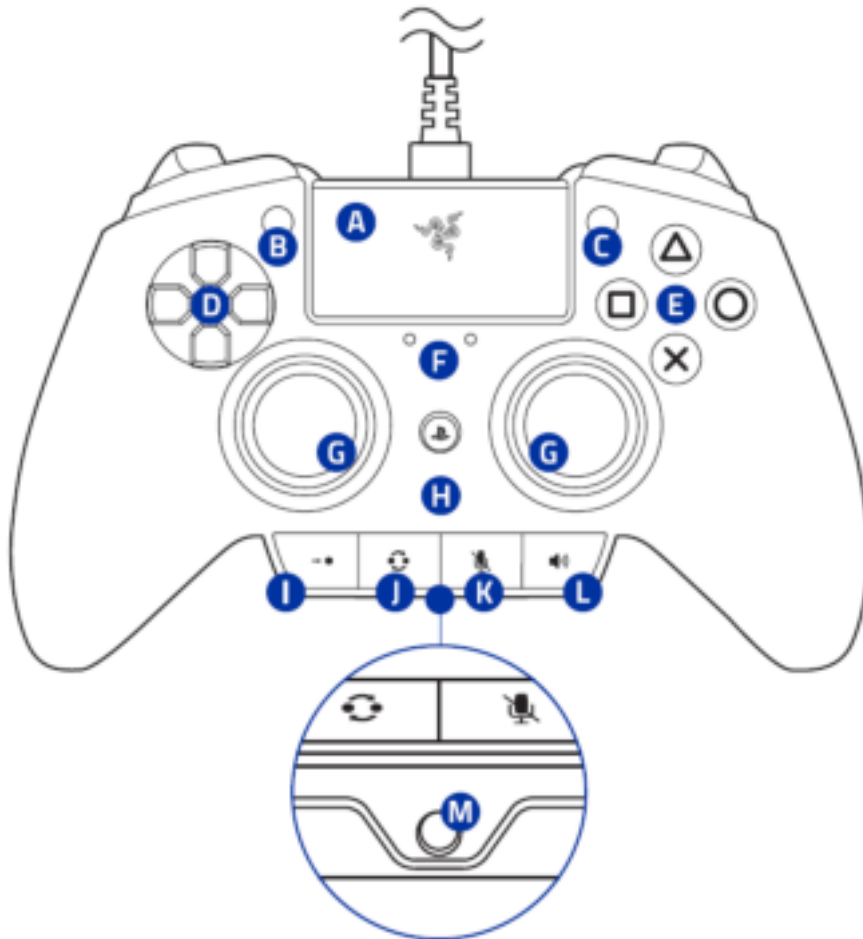

- A. Touchpad (Touchpad button)
- B. Share button
- C. Options button
- D. Directional pad
- E. Action buttons
- F. Profile indicators
- G. Analog sticks (L3 / R3 buttons)
- H. PS button
- I. Remap button
- J. Profile cycle button
- K. Mic mute button
- L. Volume control button
- M. 3.5 mm headset port

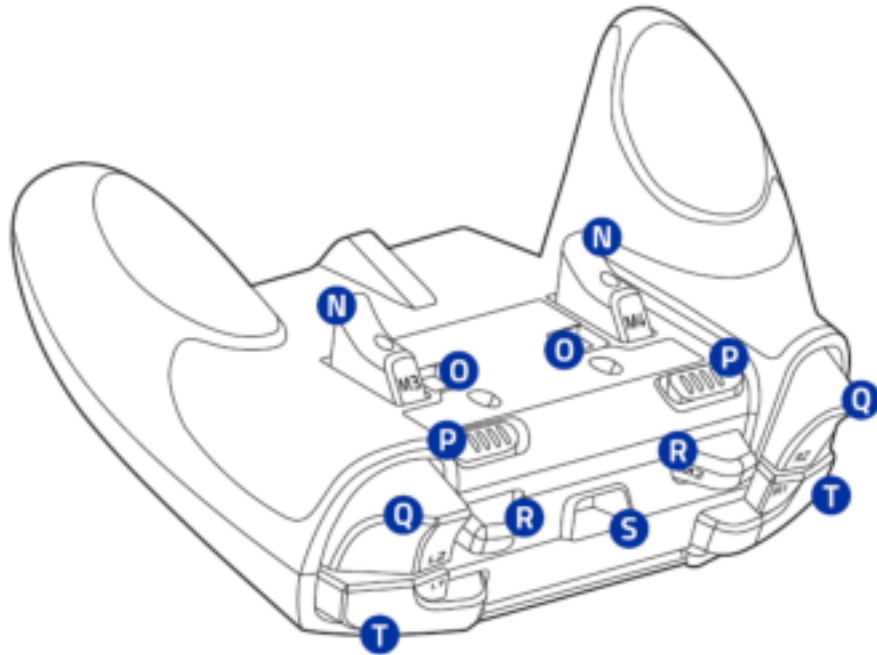

- N. Multi-function triggers (M3 / M4)
- O. Cover release switches
- P. Trigger stop switches
- Q. Trigger buttons (R2 / L2)
- R. Multi-function bumpers (M1 / M2)
- S. Detachable cable port
- T. Shoulder buttons (R1 / L1)

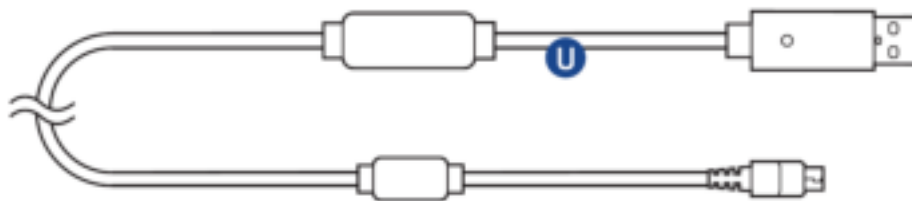

- U. Detachable braided fiber cable*

**This cable is dedicated for the Razer Raiju controller and not intended to be used with other devices.*

4. SETTING UP YOUR RAZER RAIJU

CONNECTING TO YOUR PLAYSTATION®4 CONSOLE

1. Plug the micro USB connector of the detachable braided fiber cable into your Razer Raiju.



2. Plug the USB connector of your Razer Raiju into the USB port of your PlayStation®4 console.

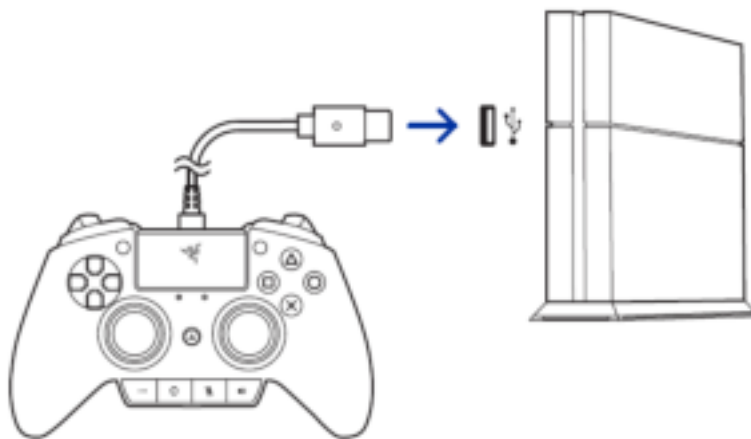

3. Press the PS button and your Razer Raiju is ready to go.



REMOVING THE MULTI-FUNCTION TRIGGERS

1. Insert the tip of the screwdriver into the Multi-Function Trigger.

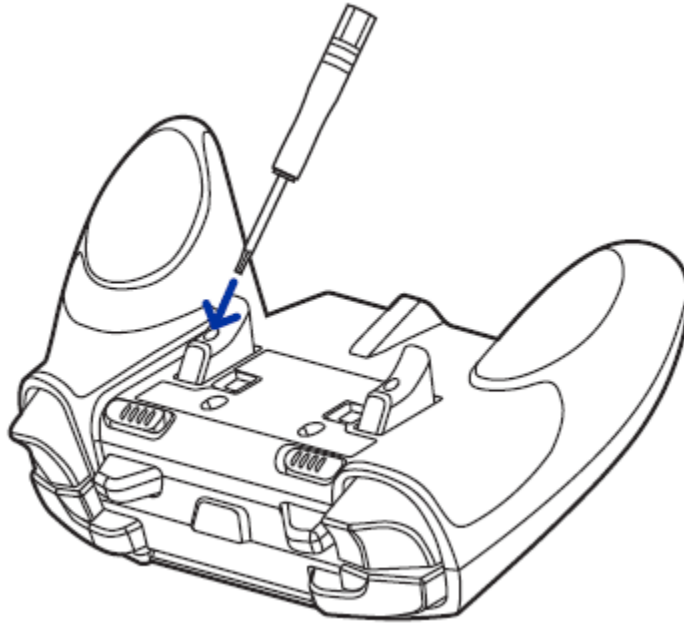

2. Turn the screwdriver counterclockwise until the screw is loose.

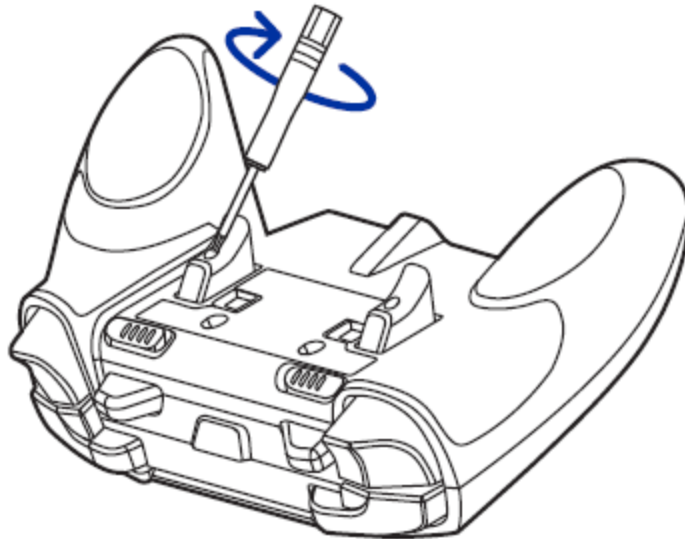

3. Remove the Multi-Function Trigger from the controller.

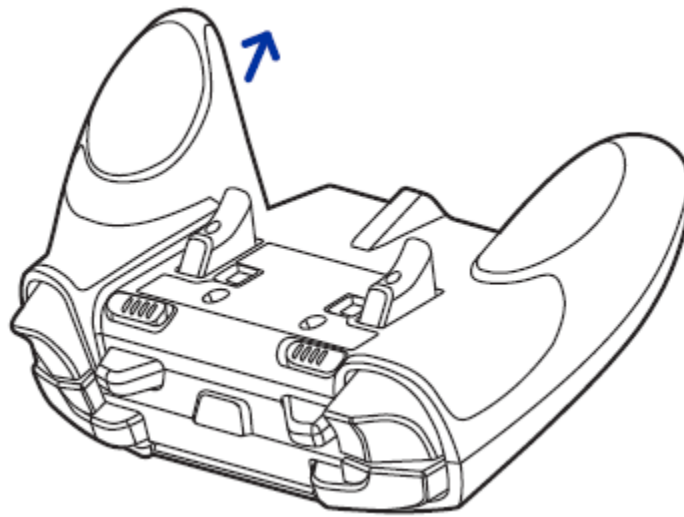

4. Close the trigger cover.

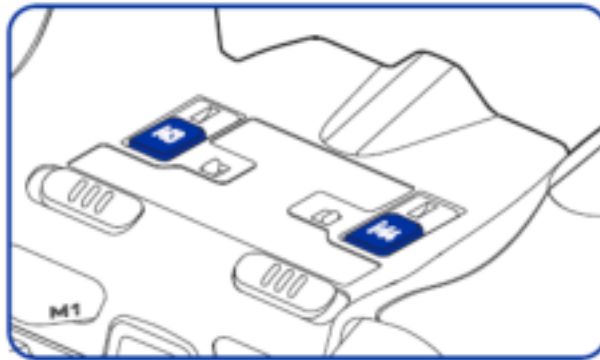

To open the trigger cover, simply pull aside the cover release switches.

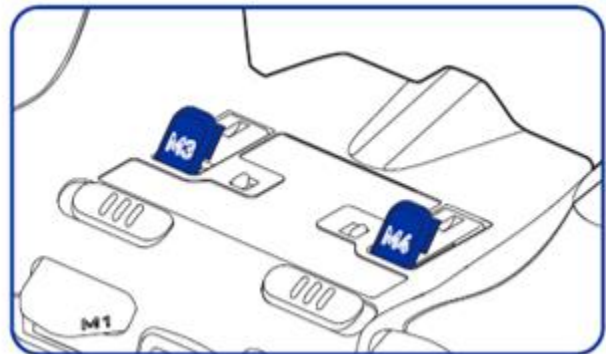
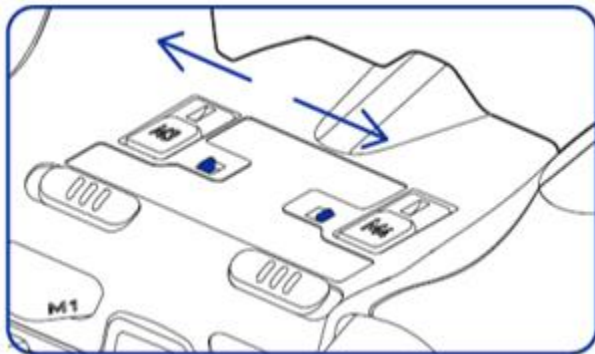

5. ADDITIONAL ACCESSORIES

ANALOG STICK RUBBER GRIP CAPS

The additional texture on the rubber grip caps prevent your thumbs from slipping off the analog sticks during intense gaming sessions.

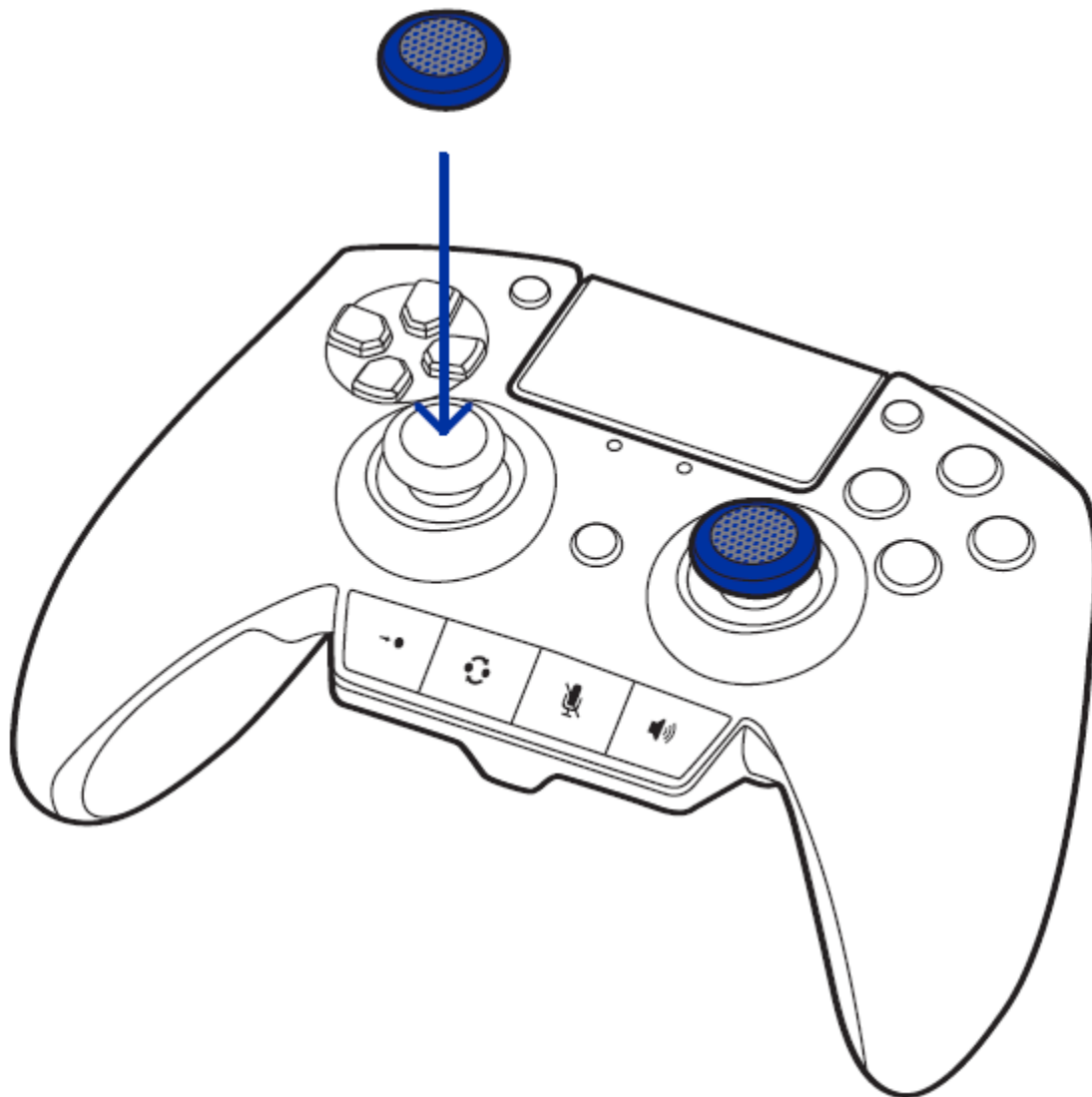

6. USING YOUR RAZER RAIJU

SELECTING A PROFILE

The Razer Raiju has a default profile and 2 custom profiles which you can use to customize the Multi-function bumpers and triggers.

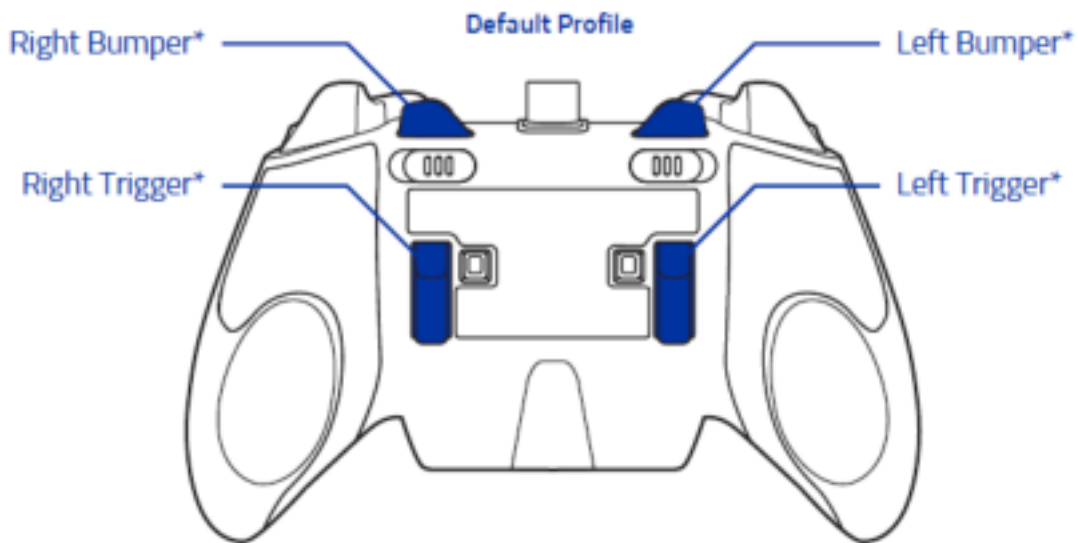

**user customizable*

Pressing the Profile button will cycle the profiles between Profile 1 and Profile 2.

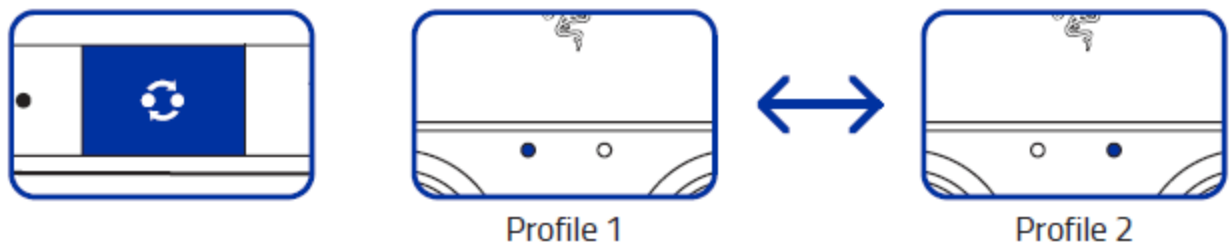

To return to default, press and hold the Profile button for at least 3 seconds until the profile indicators are both unlit.

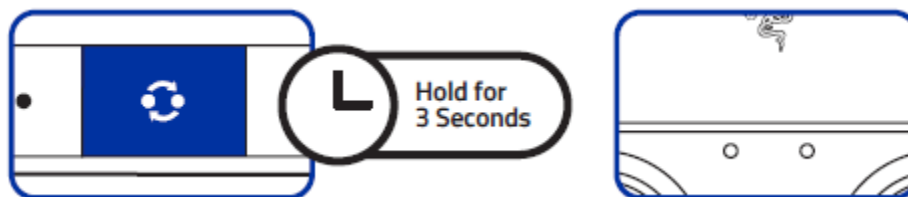

REMAPPING THE MULTI-FUNCTION TRIGGERS (MFT) AND BUMPERS (MFB)

To remap the Multi-function triggers and Multi-function bumpers, you will first need to select either Profile 1 or Profile 2. After you have selected a profile, follow these instructions:

1. Press and hold the Remap button until the active Profile Indicator blinks.



2. Press and hold the MFB or MFT you wish to configure.

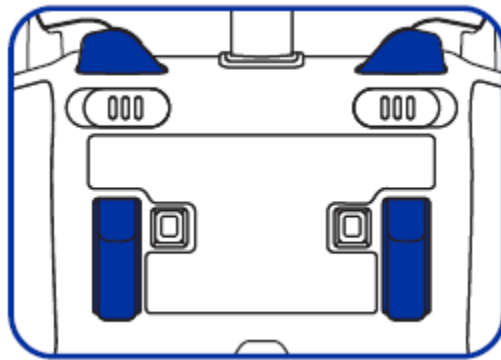

3. Press the button you want to assign to the MFB or MFT.

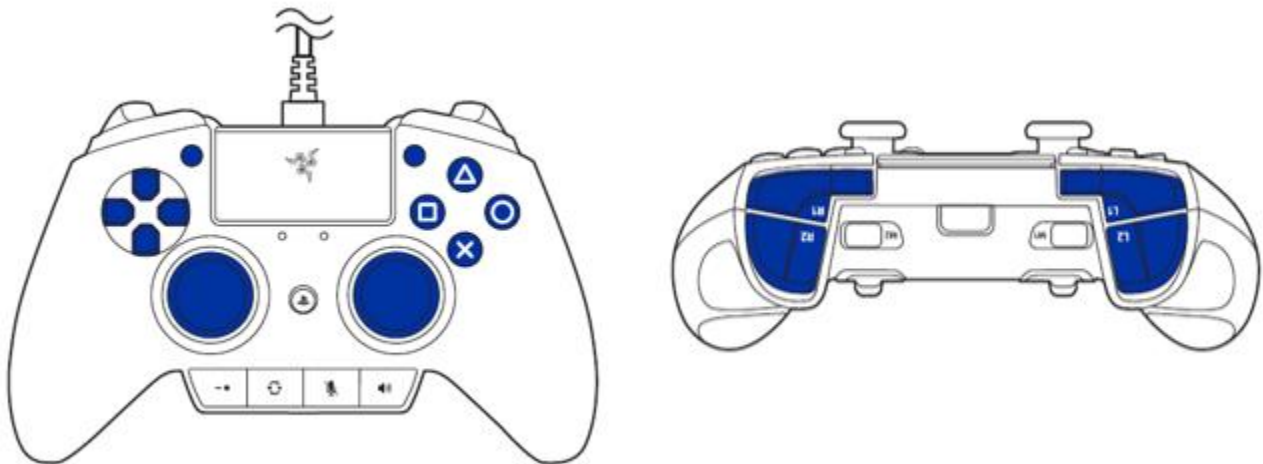

4. Release your fingers once you feel the controller vibrate.



USING THE MIC MUTE BUTTON

The mic mute button allows you to disable the microphone that is connected to the 3.5mm headset port. The button will light up to indicate that the microphone is muted.

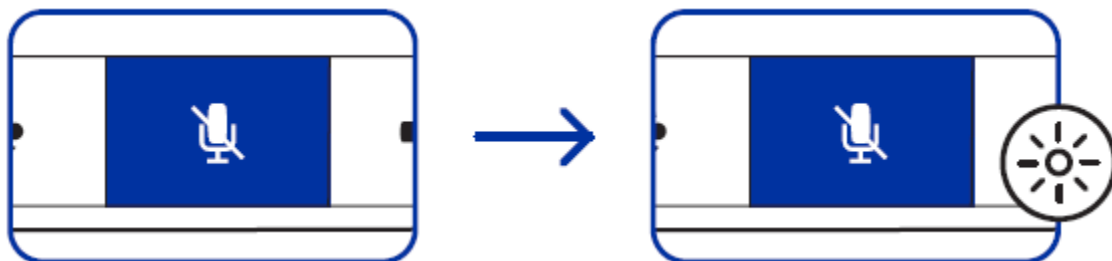

USING THE AUDIO CONTROL BUTTON

The Razer Raiju has a multi-purpose audio control button which you can use to increase or decrease the headphone volume. To increase the volume, simply press the audio control button.



To fine-tune the volume, press and hold the audio control button then press the directional pad's up or down button to increase or decrease the volume respectively.

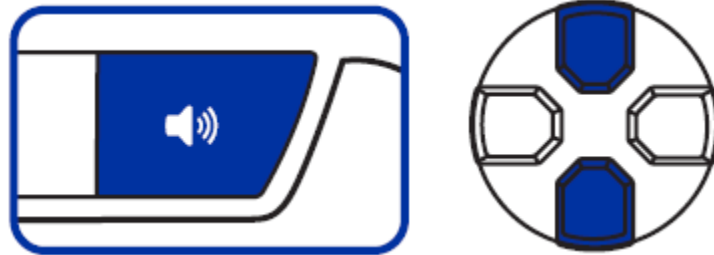

To increase the voice chat volume and decrease the game volume, press and hold the audio control button then press the directional pad's left button.

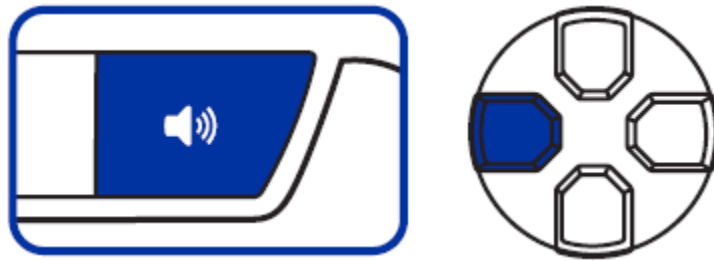

To increase the game volume and decrease the voice chat volume, press and hold the audio control button then press the directional pad's right button.



USING THE TRIGGER STOP SWITCHES

The Trigger Stops allow you to activate the Left and Right Triggers faster by shortening their travel distance. To enable the Trigger Stops, simply slide the switches outwards; and to disable the Trigger Stops, slide the switches inwards.

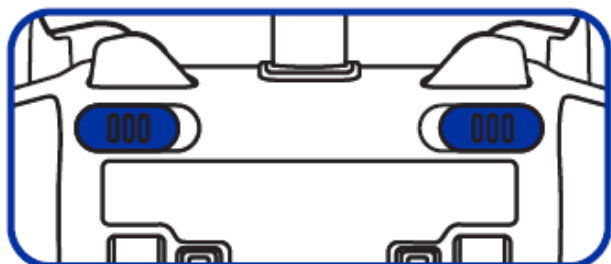

Enable

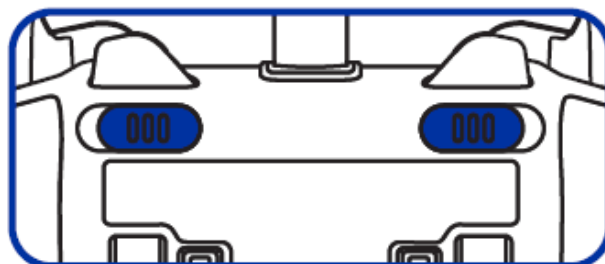

Disable

USING THE HAIR TRIGGER MODE

The Hair Trigger Mode is another alternative for activating the Left and Right Triggers faster by reducing their response time. To enable the Hair Trigger Mode:

1. Press and hold the Remap button until the active Profile Indicator blinks.

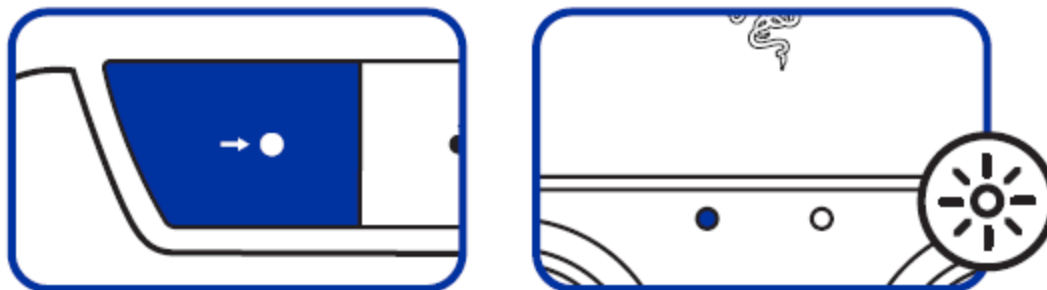

3. Press and hold the Trigger you wish to configure.

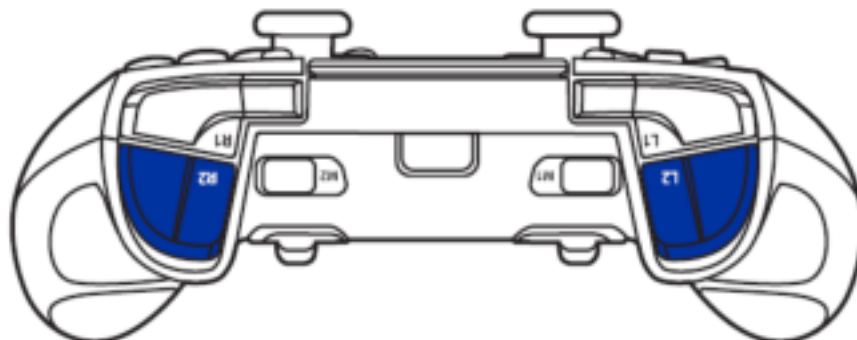

3. Press the “X” button to activate the Hair Trigger Mode.



4. Release your fingers once you feel the controller vibrate.



To disable the Hair Trigger Mode:

1. Press and hold the Remap button until the active Profile Indicator blinks.

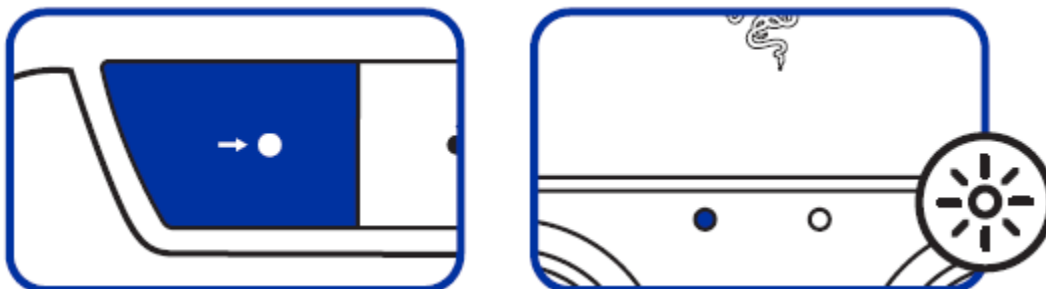

2. Press and hold the Trigger you wish to configure.

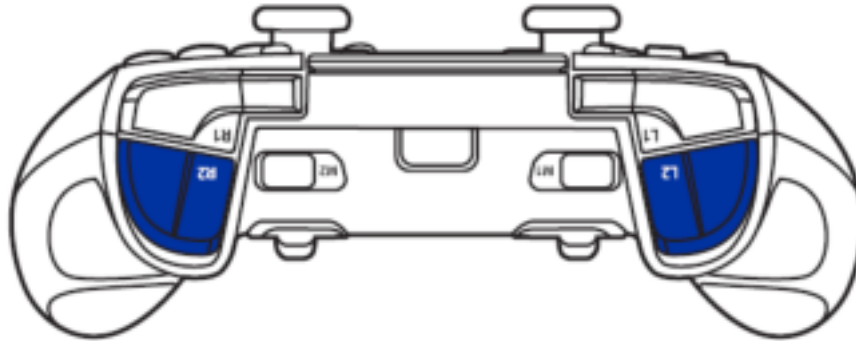

3. Press the “O” button to deactivate the Hair Trigger Mode.



4. Release your fingers once you feel the controller vibrate.



Tip: Activate both the Trigger Stop switches and the Hair Trigger Mode at the same time for unparalleled gaming performance.

7. SAFETY AND MAINTENANCE

SAFETY GUIDELINES

In order to achieve maximum safety while using your Razer Raiju, we suggest that you adopt the following guidelines:

1. Should you have trouble operating the device properly and troubleshooting does not work, unplug the device and contact the Razer hotline or go to [razersupport.com](https://www.razer.com/support) for support. Do not attempt to service or fix the device yourself at any time.
2. Do not take apart the device (doing so will void your warranty) and do not attempt to operate it under abnormal current loads.
3. Keep the device away from liquid, humidity or moisture. Operate the device only within the specific temperature range of 0°C (32°F) to 40°C (104°F). Should the temperature exceed this range, unplug and switch off the device in order to let the temperature stabilize to an optimal level.

MAINTENANCE AND USE

The Razer Raiju requires minimum maintenance to keep it in optimum condition. Once a month we recommend you unplug the device from the USB port and clean it using a soft cloth or cotton swab with a bit of warm water to prevent dirt buildup. Do not use soap or harsh cleaning agents.

8. LEGALESE

COPYRIGHT AND INTELLECTUAL PROPERTY INFORMATION

©2017 Razer Inc. All rights reserved. Razer, the triple-headed snake logo, Razer logo, “For Gamers. By Gamers.”, and “Powered by Razer Chroma” logo are trademarks or registered trademarks of Razer Inc. and/or affiliated companies in the United States or other countries. All other trademarks and trade names are the property of their respective owners and other company and product names mentioned herein may be trademarks of their respective companies.

"", "PlayStation", " ΔOX□ ", " PS3 " and " PS4 " are registered trademarks of Sony Interactive Entertainment Inc. All rights reserved.

Razer Inc. (“Razer”) may have copyright, trademarks, trade secrets, patents, patent applications, or other intellectual property rights (whether registered or unregistered) concerning the product in this guide. Furnishing of this guide does not give you license to any such copyright, trademark, patent or other intellectual property right. The Razer Raiju Gaming Controller for PS4® (the “Product”) may differ from pictures whether on packaging or otherwise. Razer assumes no responsibility for such differences or for any errors that may appear. Information contained herein is subject to change without notice.

LIMITED PRODUCT WARRANTY

For the latest and current terms of the Limited Product Warranty, please visit razerzone.com/warranty.

LIMITATION OF LIABILITY

Razer shall in no event be liable for any lost profits, loss of information or data, special, incidental, indirect, punitive or consequential or incidental damages, arising in any way out of distribution of, sale of, resale of, use of, or inability to use the Product. In no event shall Razer’s liability exceed the retail purchase price of the Product.

COSTS OF PROCUREMENT

For the avoidance of doubt, in no event will Razer be liable for any costs of procurement unless it has been advised of the possibility of such damages, and in no case shall Razer be liable for any costs of procurement liability exceeding the retail purchase price of the Product.

GENERAL

These terms shall be governed by and construed under the laws of the jurisdiction in which the Product was purchased. If any term herein is held to be invalid or unenforceable, then such term (in so far as it is invalid or unenforceable) shall be given no effect and deemed to be excluded without invalidating any of the remaining terms. Razer reserves the right to amend any term at any time without notice.