

RIVAL 710

PRODUCT INFORMATION GUIDE

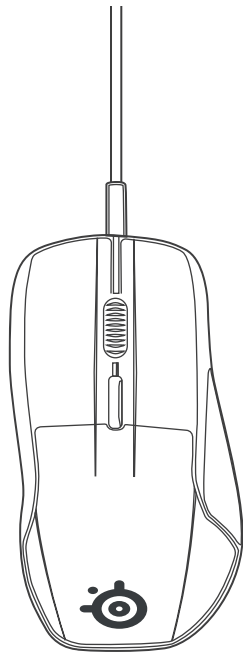

CONTENTS

Welcome	2
SteelSeries Engine	3
Product overview	5–6
Setup	7
Controls	8
Swapping/Attaching Cables	9–10
Translations	
Español	11
简体中文	12
繁體中文	13
日本語	14
한국어	16
Deutsch	17
Русский	18
Français	20
Italiano	21
Português	22
Regulatory	24

WELCOME TO RIVAL 710

The Rival 710 is the next evolutionary step to the Rival 700, updating it with the TrueMove3 sensor's true 1 to 1 tracking. Paired with customizable OLED display and tactile feedback, the Rival 710 is a jack of all trades.

find help at support.steelseries.com

STEELSERIES ENGINE

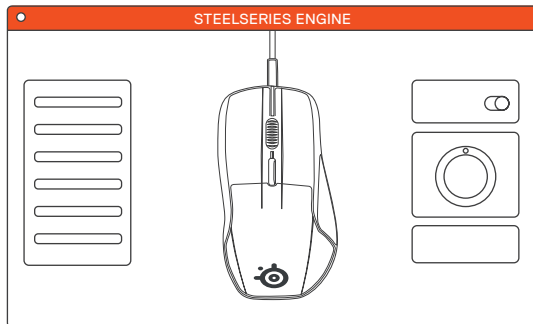

To enjoy **GameSense integration**, customize **OLED display**, customize **tactile feedback**, customize **mouse settings**, as well as **programming macros** on your new Rival 710 mouse, download SteelSeries Engine @ steelseries.com/engine

PACKAGE CONTENTS

Rival 710 Mouse

Product Information Guide

Braided USB cable, 2 m

Notebook USB cable, 1 m

Removable back cover (attached to mouse)

Removable name plate (attached to mouse)

Removable sensor module (attached to mouse)

SYSTEM REQUIREMENTS // COMPATIBILITY

PC / Mac

STEELSERIES ENGINE SOFTWARE REQUIREMENTS

Platforms

Windows 7 +

Mac OS X 10.8 +

120 MB of free hard drive space for installation

PRODUCT OVERVIEW

Find accessories and spare parts at support.steelseries.com

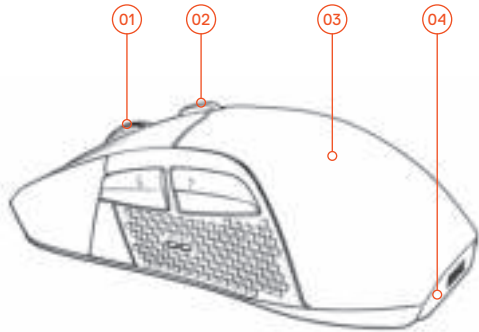

- 01 Scroll wheel
- 02 CPI button
- 03 Removable back cover (attached to mouse)
- 04 Removable name plate (attached to mouse)
- 05 Removable sensor module (attached to mouse)
- 06 Cable release lever
- 07 Cable jack
- 08 Braided USB cable, 2 m
- 09 Notebook USB cable, 1 m

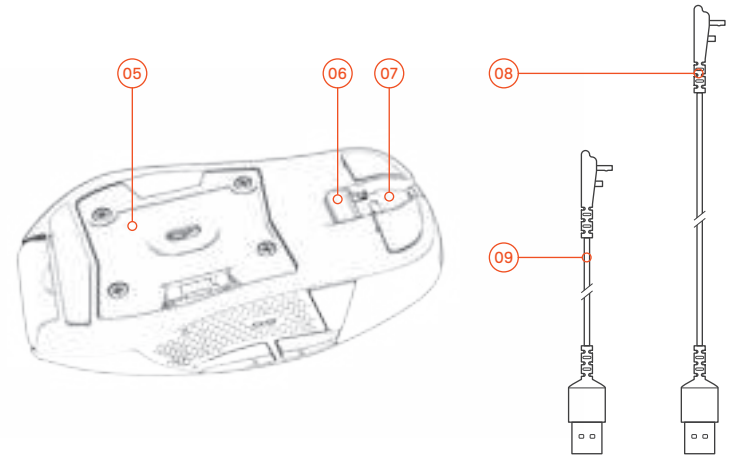

SETUP

find help at support.steelseries.com

HARDWARE INSTALLATION

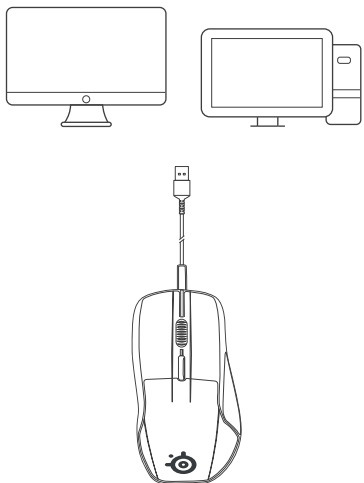

CONTROLS



01 Press and hold the CPI button  to engage built in SteelSeries Engine.

02 Use the scroll wheel  to navigate.

03 Press the scroll wheel  to select / hit Ok.

04 Press the CPI button  to go back.

SWAPPING / ATTACHING CABLES



find help at support.steelseries.com

REMOVING CABLE



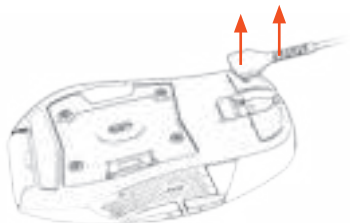

- 01 Press cable release button  to release the cable  / .



- 02 Remove the cable  /  by lifting the front of the head as well as the stress relief. Moving the cable away from the mouse.



Do not remove the cable  /  at an angle, as it would cause undue stress.

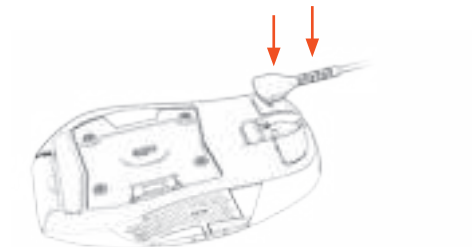

- 03 Attach the cable  /  by evenly pushing it into place.

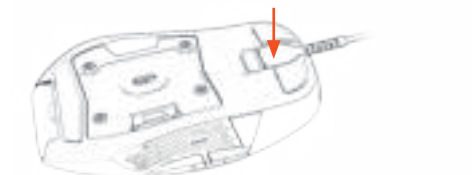

ESPAÑOL

Contenido del paquete

Ratón Rival 710

Guía de información del producto

Cable USB trenzado, 2 m

Cable USB para Notebook, 1 m

Cubierta posterior desmontable (acoplada al ratón)

Placa de identificación desmontable (acoplada al ratón)

Módulo desmontable del sensor (acoplado al ratón)

Requisitos del sistema // Compatibilidad

PC/Mac

Requisitos de software de SteelSeries Engine

Plataformas

Windows 7 +

Mac OS X 10.8 +

120 MB de espacio libre en el disco duro para la instalación

encuentre ayuda en support.steelseries.com

DESCRIPCIÓN GENERAL DEL PRODUCTO

01 Rueda de desplazamiento

02 Botón CPI del mouse

03 Cubierta posterior desmontable (acoplada al ratón)

04 Placa de identificación desmontable (acoplada al ratón)

05 Módulo desmontable del sensor (acoplado al ratón)

06 Palanca de liberación del cable

07 Conector del cable

08 Cable USB trenzado, 2 m

09 Cable USB para Notebook, 1 m

Encuentre accesorios y repuestos en steelseries.com/gaming-accessories

CONFIGURACIÓN

Instalación del hardware

encuentre ayuda en support.steelseries.com

Controles

01 Mantenga pulsado el botón CPI  para activar el software integrado SteelSeries Engine.

02 Use la rueda de desplazamiento  para navegar.

03 Presione la rueda de desplazamiento  para seleccionar/pulsar ACEPTAR.

04 Pulse el botón CPI  para volver.

Intercambio/conexión de cables

01 Pulse el botón de liberación del cable  para soltarlo .

02 Retire el cable /  tirando simultáneamente del cabezal y del liberador de tensión. Separe el cable

del ratón.

03 No retire el cable /  formando un ángulo, ya que la tensión podría ser excesiva.

04 Conecte el cable /  presionando de manera uniforme hasta que encaje en su sitio.

encuentre ayuda en support.steelseries.com

简体中文

包装内容

Rival 710 鼠标

产品信息指南

USB 编织线缆，2 米

笔记本电脑 USB 线缆，1 米

可拆卸底座（鼠标附带组件）

可拆卸铭牌（鼠标附带组件）

可拆卸传感器模块（鼠标附带组件）

系统要求 // 兼容性

PC / Mac

SteelSeries Engine 系统要求

平台

Windows 7 +

Mac OS X 10.8 +

安装需 120 MB 可用硬盘空间

在 support.steelseries.com 寻求帮助

产品概览

01 滚轮

02 CPI 按钮

03 可拆卸底座（鼠标附带组件）

04 可拆卸铭牌（鼠标附带组件）

05 可拆卸传感器模块（鼠标附带组件）

06 线缆释放杆

07 线缆插槽

08 USB 编织线缆，2 米





09 笔记本电脑 USB 线缆，1 米

* 在 steelseries.com/gaming-accessories 查找配件和零件

设置

硬件安装

控制

- 01 按住 CPI 按钮  调用内置 SteelSeries Engine。
- 02 使用滚轮  进行浏览。
- 03 按滚轮  选择/点击确定。
- 04 按 CPI 按钮  返回。

繁體中文

包装内容

Rival 710 滑鼠

產品資料

- 編織 USB 連接線，2 米
- 筆記型電腦 USB 連接線，1 米
- 可拆卸後蓋（連接到滑鼠）
- 可拆卸名牌（連接到滑鼠）
- 可拆卸感應器（連接到滑鼠）

系統要求//兼容性

PC / Mac

更換/连接线缆

- 01 按线缆释放杆 ，释放线缆 / 。
- 02 向上抬起接头前端和应力锥，拆除线缆 / 。将线缆从鼠标上拿开。
- 03 请勿斜拉拆除线缆 / ，以免产生过大的应力。
- 04 将线缆 /  均匀地推入到位，以进行连接。

SteelSeries Engine 軟體需求

平台

Windows 7 +
Mac OS X 10.8 +

安裝時需要有 120 MB 可用的硬碟容量

訪問 support.steelseries.com 尋求幫助

產品介紹

- 01 滾輪
- 02 CPI 按鈕
- 03 可拆卸後蓋（連接到滑鼠）
- 04 可拆卸名牌（連接到滑鼠）

05 可拆卸感應器（連接到滑鼠）

06 連接線分離卡榫

07 連接線插槽

08 編織 USB 連接線，2 米

09 筆記型電腦 USB 連接線，1 米

在 steelseries.com/gaming-accessories 查找配件和零件

設定

硬體安裝

控制器

- 01 按住 CPI 按鈕  以啟動內建的 SteelSeries

日本語

パッケージの内容

マウス (Rival 710)

製品に関する情報 (ガイド)

編組USB ケーブル (2m)

ノートパソコン用USB ケーブル (1m)

取り外し可能なバックカバー (マウスに取り付けられています)

取り外し可能なネームプレート (マウスに取り付

Engine)。

02 使用滚輪  來瀏覽選單。

03 按下滚輪鍵  來選擇功能。

04 按下 CPI 按钮  返回。

在 support.steelseries.com 尋求幫助

更換/連接線

01 按下連接線分離卡榫  鬆開連接線 / 。

02 將連接線頭部稍微往上提並輕輕壓下，以鬆開連接線 / 。將連接線從滑鼠中拔出。

03 請勿將連接線 /  有角度地拔出，這樣會造成不必要的壓力。

04 將連接線 /  平推入插口。

けられています)

取り外し可能なセンサーモジュール (マウスに取り付けられています)

システム要件 // 互換性

PC / Mac

SteelSeries Engineのソフトウェア要件

プラットフォーム

Windows 7 +
Mac OS X 10.8 +

インストール用のハードドライブ空き容
量: 120MB

support.steelseries.comにアクセスして、その他の
提案やサポートをご覧ください

製品概要





- 01 スクロールホイール
- 02 CPIボタン
- 03 取り外し可能なバックカバー (マウスに取り付けられています)
- 04 取り外し可能なネームプレート (マウスに取り付けられています)
- 05 取り外し可能なセンサーモジュール (マウスに取り付けられています)
- 06 ケーブルリリースレバー
- 07 ケーブルジャック
- 08 編組USB ケーブル (2m)
- 09 ノートパソコン用USB ケーブル (1m)

* アクセサリーや交換部品をお求めの場合は、steelseries.com/gaming-accessoriesで情報をご覧ください。









セットアップ

ハードウェアのインストール

コントロール

- 01 CPIボタン  を長押しして、内蔵のSteelSeries Engineと連動します。
- 02 スクロールホイール  を使用してナビゲートします。
- 03 スクロールホイール  を押して、[OK]を選択します/押します。
- 04 CPIボタン  を押して戻ります。

ケーブルの交換/取り付け

- 01 ケーブルのリリースボタン  を押してケーブル  /  のロックを解除します。
- 02 ヘッドのフロントと負荷緩和用パーツを持ち上げてケーブル  /  を取り外します。ケーブルをマウスから離します。
- 03 過度の負荷がかかることがあるため、斜めにケーブル  /  を取り外さないでください。
- 04 均一にケーブルを所定の位置に押し込み、ケーブル  /  を取り付けます。ボタンを2秒間押し続けると、再調整が強制的に実行されます。リフトオフの調整が完了すると、Rival 600は白く3回点滅します。

한국어

패키지 내용물

- Rival 710 마우스
- 제품 정보 안내
- 편복 USB 케이블, 2m
- 노트북 USB 케이블, 1m
- 착탈식 후면 커버(마우스에 부착)
- 착탈식 명판(마우스에 부착)
- 착탈식 센서 모듈(마우스에 부착)

시스템 요구 사항 // 호환성

PC / Mac

SteelSeries Engine 소프트웨어 요구사항

플랫폼

- Windows 7 이상
- Mac OS X 10.8 이상

설치를 위한 120MB 여유 하드 드라이브 공간

고객 지원은 support.steelseries.com을 방문하세요

제품 개요

- 01 스크롤 휠
- 02 CPI 버튼

- 03 착탈식 후면 커버(마우스에 부착)
- 04 착탈식 명판(마우스에 부착)
- 05 착탈식 센서 모듈(마우스에 부착)
- 06 케이블 릴리즈 레버
- 07 케이블 잭
- 08 편복 USB 케이블, 2m
- 09 노트북 USB 케이블, 1m

* 액세서리와 대체 부품은 steelseries.com/gaming-accessories에서 구하세요





설정

하드웨어 설치

컨트롤

- 01 CPI 버튼  을 길게 눌러 내장된 SteelSeries Engine을 작동합니다.
 - 02 스크롤 휠  을 이용해 이동합니다.
 - 03 스크롤 휠  을 눌러 선택하고/Ok를 누릅니다.
 - 04 CPI 버튼  을 눌러 뒤로 돌아옵니다.
- 고객 지원은 support.steelseries.com을 방문하세요

케이블 교환/연결

- 01 케이블 분리 버튼  을 눌러 케이블  /  을 분리합니다.
- 02 헤드의 앞쪽과 케이블 연결부를 동시에 들어올려 케이블  /  을 분리합니다. 케이블을

DEUTSCH

Lieferumfang

Maus Rival 710

Produktinformationshandbuch

Geflochtenes USB-Kabel, 2 m

Notebook-USB-Kabel, 1 m

Abnehmbare Abdeckung (montiert)

Abnehmbare Namensplakette (montiert)

Abnehmbares Sensormodul (montiert)

Systemanforderungen // Kompatibilität

PC / Mac





SteelSeries Engine – Softwareanforderungen

Plattformen

Windows 7 +
Mac OS X 10.8 +

120 MB freier Festplattenspeicherplatz zur Installation

마우스로부터 떼어냅니다.

- 03 케이블  /  을 기울여 분리하지 마십시오. 지나친 응력이 가해질 수 있습니다.
- 04 케이블  /  을 균일한 힘으로 눌러 부착합니다.

Sie brauchen Hilfe? support.steelseries.com

PRODUKTÜBERSICHT

- 01 Scroll-Rad
- 02 CPI-Taste
- 03 Abnehmbare Abdeckung (montiert)
- 04 Abnehmbare Namensplakette (montiert)
- 05 Abnehmbares Sensormodul (montiert)
- 06 Kabel-Entriegelung
- 07 Kabelbuchse
- 08 Geflochtenes USB-Kabel, 2 m
- 09 Notebook-USB-Kabel, 1 m

*Zubehör und Ersatzteile finden Sie bei steelseries.com/gaming-accessories

EINRICHTUNG

Hardware-Installation

Bedienelemente

- 01 Halten Sie die CPI-Taste  gedrückt, um die integrierte Software SteelSeries Engine zu starten.
 - 02 Verwenden Sie das Scroll-Rad  zum Navigieren.
 - 03 Drücken Sie auf das Scroll-Rad , um eine Option auszuwählen oder mit OK zu bestätigen.
 - 04 Drücken Sie die CPI-Taste , um zurückzukehren
- Sie brauchen Hilfe? support.steelseries.com

РУССКИЙ

Содержимое комплекта

Манипулятор «мышь» Rival 710

Справочник по продукту

Кабель USB, с оплеткой, 2 м









Кабель USB для ноутбука, 1 м

Съемная задняя крышка (прилагается к мыши)

Съемная паспортная табличка (прилагается к мыши)

Съемный модуль датчика (прилагается к мыши)

Austauschen/Anschließen der Kabel

- 01 Drücken Sie auf die Kabel-Entriegelung , um das Kabel  /  zu lösen.
- 02 Ziehen Sie das Kabel  /  heraus, indem Sie das vordere Kabelende zusammen mit der Zugentlastung nach oben abnehmen und das Kabel so von der Maus trennen.
- 03 Ziehen Sie das Kabel  /  nicht schräg ab, da dies zu einer übermäßigen Zugbelastung führt.
- 04 Schließen Sie das Kabel  /  an, indem Sie es mit gleichmäßigem Druck in die Kabelbuchse drücken.

Требования к системе // совместимость

ПК / Мак

Требования к ПО SteelSeries Engine

Платформы

Windows 7 +
Mac OS X 10.8 +

120 Мб свободного пространства на жестком диске для инсталляции

Помощь: support.steelseries.com

ОБЗОР ПРОДУКТА

- 01 Колесико прокрутки
- 02 Кнопка CPI
- 03 Съёмная задняя крышка (прилагается к мыши)
- 04 Съёмная паспортная табличка (прилагается к мыши)
- 05 Съёмный модуль датчика (прилагается к мыши)
- 06 Рычаг отсоединения кабеля
- 07 Кабельный разъем
- 08 Кабель USB, с оплеткой, 2 м
- 09 Кабель USB для ноутбука, 1 м

* Аксессуары и запчасти можно купить на сайте steelseries.com/gaming-accessories

НАСТРОЙКА

Установка аппаратуры

Органы управления

- 01 Нажмите и удерживайте кнопку CPI  для включения встроенного SteelSeries Engine.
 - 02 Для навигации пользуйтесь колесиком прокрутки .
 - 03 Для выбора/нажатия ОК нажмите колесико прокрутки .
 - 04 Нажмите кнопку CPI  для возврата назад.
- Помощь: support.steelseries.com

Переброска/присоединение кабелей

- 01 Нажмите кнопку отсоединения кабеля  для отсоединения кабеля  / .
- 02 Выньте кабель  / , подняв переднюю часть головки, а также напуск проводки. Снятие кабеля с мыши.
- 03 При снятии не тяните кабель  /  с перекосом, поскольку это ведет к излишнему механическому напряжению.
- 04 Вставляйте кабель  /  на место равномерным нажатием.

FRANÇAIS

Contenu de l'emballage

- Souris Rival 710
- Guide d'informations sur le produit
- Câble USB tressé, 2 m
- Câble USB pour portable, 1 m
- Coque arrière amovible (fixée à la souris)
- Plaque signalétique amovible (fixée à la souris)
- Module capteur amovible (fixé à la souris)

Configuration système requise // Compatibilité

PC / Mac

Exigences du logiciel SteelSeries Engine

- Plateformes
 - Windows 7 +
 - Mac OS X 10.8 +
- 120 Mo d'espace disque dur libre pour l'installation
- assistance disponible à l'adresse support.steelseries.com

Vue d'ensemble du produit

- 01 Molette de défilement
- 02 Bouton CPI





- 03 Coque arrière amovible (fixée à la souris)
- 04 Plaque signalétique amovible (fixée à la souris)
- 05 Module capteur amovible (fixé à la souris)
- 06 Levier de dégagement du câble
- 07 Prise de câble
- 08 Câble USB tressé, 2 m
- 09 Câble USB pour portable, 1 m

* Accessoires et pièces de rechange disponibles à l'adresse steelseries.com/gaming-accessories

INSTALLATION





Installation de matériel

Contrôles

- 01 Maintenez enfoncé le bouton CPI  pour engager le SteelSeries Engine intégré.
- 02 Utilisez la molette de défilement  pour naviguer.
- 03 Appuyez sur la molette de défilement  pour sélectionner / cliquer sur OK.
- 04 Appuyez sur le bouton CPI  pour revenir en arrière.

assistance disponible à l'adresse support.steelseries.com

Permutation / fixation de câbles

- 01 Appuyez sur le bouton de libération du câble  / .
- 02 Retirez le câble  /  en soulevant l'avant de la tête ainsi que le dispositif anti-tension. Écartez le

ITALIANO

Contenuto della confezione

- Mouse Rival 710
- Manuale del prodotto
- Cavo USB intrecciato da 2 m
- Cavo USB per notebook da 1 m
- Coperchio posteriore rimovibile (montato sul mouse)
- Piastra del nome rimovibile (montata sul mouse)
- Modulo sensore estraibile (montato sul mouse)





Requisiti di sistema//Compatibilità

PC / Mac

Requisiti software SteelSeries Engine

Piattaforme
Windows 7 +
Mac OS X 10.8 +

câble de la souris.

- 03 Ne retirez pas le câble  /  de biais, faute de quoi vous générerez des contraintes anormales.
- 04 Fixez le câble  /  en le poussant uniformément en place.

120 MB di spazio libero sul disco rigido per l'installazione

Per assistenza visita support.steelseries.com

PANORAMICA DEL PRODOTTO



- 01 Rotellina di scorrimento
- 02 Pulsante DPI
- 03 Coperchio posteriore rimovibile (montato sul mouse)
- 04 Piastra del nome rimovibile (montata sul mouse)
- 05 Modulo sensore estraibile (montato sul mouse)
- 06 Pulsante di sblocco del cavo
- 07 Jack del cavo
- 08 Cavo USB intrecciato da 2 m
- 09 Cavo USB per notebook da 1 m

* Trova accessori e parti di ricambio su steelseries.com/gaming-accessories

CONFIGURAZIONE

Installazione dell'hardware

Controlli

- 01 Premere e tenere premuto il pulsante DPI  per attivare lo SteelSeries Engine integrato.
- 02 Utilizzare la rotellina di scorrimento  per spostarsi.
- 03 Premere la rotellina di scorrimento  per selezionare/scegliere Ok.









PORTUGUÊS

Conteúdos da Embalagem

- Rato Rival 710
- Guia de Informações do Produto
- Cabo USB entrançado, 2 m
- Cabo USB para portátil, 1 m
- Tampa traseira removível (fixada ao rato)
- Placa do nome removível (fixada ao rato)
- Módulo do sensor removível (fixado ao rato)

- 04 Premere il pulsante DPI  per tornare indietro.
Per assistenza visita support.steelseries.com

Collegamento/Sostituzione dei cavi

- 01 Premere il pulsante di sblocco del cavo  per permettere la rimozione del cavo  / .
- 02 Scollegare il cavo  /  sollevando sia la testa che la parte protettiva del jack. Rimuovere il cavo dal mouse.
- 03 Non rimuovere il cavo  /  inclinandolo per evitare sollecitazioni eccessive.
- 04 Collegare il cavo  /  spingendolo uniformemente in posizione.

Requisitos de sistema // Compatibilidade

PC / Mac

Requisitos de software Motor SteelSeries

Plataformas
Windows 7 +
Mac OS X 10.8 +
Disco rígido 120 MB de espaço livre para instalação
obtenha ajuda em support.steelseries.com

VISÃO GERAL DO PRODUTO





- 01 Roda do rato
- 02 Botão CPI
- 03 Tampa traseira removível (fixada ao rato)
- 04 Placa do nome removível (fixada ao rato)
- 05 Módulo do sensor removível (fixado ao rato)
- 06 Alavanca de libertação do cabo
- 07 Cabo jack
- 08 Cabo USB entrançado, 2 m
- 09 Cabo USB para portátil, 1 m

* Encontre acessórios e peças de reposição em steelseries.com/gaming-accessories









CONFIGURAÇÃO

Instalação de hardware

Controlos

- 01 Prima e mantenha premido o botão CPI  para ativar o motor SteelSeries.
 - 02 Utilize a roda do rato  para navegar.
 - 03 Prima a roda do rato  para selecionar/prima Ok.
 - 04 Pressione o botão CPI  para voltar.
- obtenha ajuda em support.steelseries.com

Cabos de ligação/troca

- 01 Prima o botão de libertação do cabo  para soltar o cabo  / .
- 02 Remova o cabo  /  levantando a parte dianteira da cabeça, bem como o alívio de pressão. Mova o cabo para longe do rato.
- 03 Não remova o cabo  /  num ângulo, pois isso iria provocar pressão desnecessária.
- 04 Encaixe o cabo  /  empurrando uniformemente para a posição correta.

REGULATORY



Europe – EU Declaration of Conformity

Hereby, SteelSeries ApS. declares that the equipment which is compliance with directive RoHS 2.0 (2015/863/EU), R.E.D (2014/53/EU), EMC Directive (2014/30/EU), and LVD (2014/35/EU) which are issued by the Commission of the European Community.

The full text of the EU declaration of conformity is available at the following internet address: <https://steelseries.com/>

SteelSeries ApS. hereby confirms, to date, based on the feedback from our suppliers indicates that our products shipping to the EU territory comply with REACH (Registration, Evaluation, Authorization, and Restriction of Chemicals - (EC) 1907/2006) compliance program. We are fully committed to offering REACH compliance on the products and posting accurate REACH compliance status for the all of products.

WEEE

This product must not be disposed of with your other household waste or treat them in compliance with the local regulations or contact your local city office, your household waste disposal service or the shop where you purchased the product.



Türkiye Cumhuriyeti: EEE Yönetmeliğine Uygundur

Ukraine RoHS:

Обладнання відповідає вимогам Технічного регламенту щодо обмеження використання деяких небезпечних речовин в електричному та електронному обладнанні, затвердженого постановою Кабінету Міністрів України від 3 грудня 2008 № 1057

This product is compliant with requirements of Circular No. 30/2011/TT-BCT Regulations "STIPULATING TEMPORARILY THE PERMISSIBLE CONTENT LIMITATION OF SOME TOXIC CHEMICALS IN THE ELECTRONIC, ELECTRICAL PRODUCTS"

Restriction on Hazardous Substances statement (India)

This product complies with the "India E-waste Rule 2011" and prohibits use of lead, mercury, hexavalent chromium, polybrominated biphenyls or polybrominated diphenyl ethers in concentrations exceeding 0.1 weight % and 0.01 weight % for cadmium, except for the exemptions set in Schedule 2 of the Rule.

《废弃电器电子产品回收处理管理条例》提示性说明

为了更好地关爱及保护地球，当用户不再需要此产品或产品寿命终止时，请遵守国家废弃电器电子产品回收处理相关法律法规，将其交给当地具有国家认可的回收处理资质的厂商进行回收处理。



Federal Communication Commission Interference Statement

This device complies with Part 15 of the FCC Rules. Operation is subject to the following two conditions: (1) This device may not cause harmful interference, and (2) this device must accept any interference received, including interference that may cause undesired operation.

This equipment has been tested and found to comply with the limits for a Class B digital device, pursuant to Part 15 of the FCC Rules. These limits are designed to provide reasonable protection against harmful interference in a residential installation. This equipment generates, uses and can radiate radio frequency energy and, if not installed and used in accordance with the instructions, may cause harmful interference to radio communications. However, there is no guarantee that interference will not occur in a particular installation. If this equipment does cause harmful interference to radio or television reception, which can be determined by turning the equipment off and on, the user is encouraged to try to correct the interference by one of the following measures:

- Reorient or relocate the receiving antenna.
- Increase the separation between the equipment and receiver.
- Connect the equipment into an outlet on a circuit different from that to which the receiver is connected.
- Consult the dealer or an experienced radio/TV technician for help.

FCC Caution: Any changes or modifications not expressly approved by the party responsible for compliance could void the user's authority to operate this equipment.

This Class B digital apparatus complies with Canadian ICES-003.
Cet appareil numérique de la classe B est conforme à la norme NMB-003 du Canada.

이 기기는 가정용(B급) 전자파적합기로서 주로 가정에서 사용하는 것을 목적으로 하며, 모든 지역에서 사용할 수 있습니다



この装置は、情報処理装置等電波障害自主規制協議会(VCCI)の基準に基づくクラスB情報技術装置です。この装置、家庭環境で使用することを目的としていますが、この装置がラジオやテレビジョン受信機に近接して使用されると、受信障害を引き起こすことがあります。取扱説明書に従って正しい取り扱いをしてください。

The RoHS test method is based on the standards JIS C 0950 and CNS 15663

設備名稱: Equipment name	滑鼠/Mouse		型號 (型式): Type designation	M- 000 15		
單元 Unit	限用物質及其化學符號 Restricted substances and its chemical symbols					
	鉛 Lead (Pb)	汞Mercury (Hg)	鎘Cadmium (Cd)	六價鉻 Hexavalent chromium (Cr+6)	多溴聯苯 Polybrominated biphenyls (PBB)	多溴二苯醚 Polybrominated diphenyl ethers (PBDE)
塑膠部件/Plastic	○	○	○	○	○	○
電路板及元件/PCBA	—	○	○	○	○	○
線材/Cables	—	○	○	○	○	○
金屬部件/Metal	—	○	○	○	○	○
<p>備考1. “超出0.1 wt %”及“超出0.01 wt %”係指限用物質之百分比含量超出百分比含量基準值。 Note 1: “Exceeding 0.1 wt %” and “exceeding 0.01 wt %” indicate that the percentage content of the restricted substance exceeds the reference percentage value of presence condition.</p> <p>備考2. “○”係指該項限用物質之百分比含量未超出百分比含量基準值。 Note 2: “○” indicates that the percentage content of the restricted substance does not exceed the percentage of reference value of presence.</p> <p>備考3. “—”係指該項限用物質為排除項目。 Note 3: The “—” indicates that the restricted substance corresponds to the exemption</p>						

根据中国大陆《电子电气产品有害物质限制使用标识要求》，以下部分列出了产品中可能包含的有害物质的名称和含量：						
零部件名称	有害物质					
	铅 (Pb)	汞 (Hg)	镉 (Cd)	六价铬 (Cr(VI))	多溴联苯 (PBB)	多溴二苯醚 (PBDE)
电路板组件	×	○	○	○	○	○
其他线材	×	○	○	○	○	○
*：电路板组件包括印刷电路板及其构成的零部件，如电阻、电容、集成电路、连接器等。						
<p>本表格依据SJ/T 11364的规定编制。</p> <p>○：表示该有害物质在该部件所有均质材料中的含量均在 GB/T 26572规定的限量要求以下。</p> <p>×：表示该有害物质至少在该部件的某一均质材料中的含量超出GB/T 26572规定的限量要求；</p> <p>上表中打“×”的部件，应功能需要，部分有害物质含量超出GB/T 26572规定的限量要求，但是符合欧盟RoHS法规要求(属于豁免部分)。</p>						



该电子电气产品含有某些有害物质，在环保使用期限内可以放心使用。超过环保使用期限之后则应该进入回收循环系统。



Custom Union Compliance.
(Russia / Belarus / Kazakhstan)



ACMA Compliance (Australia/ New-Zealand)



Direct Current



1. 상호명: SteelSeries ApS.
2. 기기명칭: Mouse
3. 모델명: M-00015
4. 인증번호: R-REM-SS4-M-00015
5. 제조사/제조국: SteelSeries ApS./China

Regions	Contact Information	
Asia 亞洲	16F, No.150, Jian-Yi Rd., Chung-Ho Dist, New Taipei City, Taiwan, R.O.C.(235) 丹麥商賽睿有限公司 新北市中和區建一路150號16樓	+886 2 8226 3858
USA	656 W Randolph St, Suite 3E Chicago, IL 60661, USA	+1 312 258 9467
Europe	Dirch Passers Allé 27, 5.Sal 2000 Frederiksberg, Denmark	+45 702 500 75

More information and support at steelseries.com

Product Name(產品名稱/产品名称): Mouse (滑鼠/鼠标)

Model No. (型號/型号): M-00015

Rated (規格/规格): 5V ---, 200mA

Made in China 中國製造/中国制造

Operating Temperature: 0 to + 40 °C



learn more at steelseries.com