

# ONKYO

## Network Tuner

# T-4070

## Instruction Manual

Thank you for purchasing an Onkyo Network Tuner. Please read this manual thoroughly before making connections and plugging in the unit. Following the instructions in this manual will enable you to obtain optimum performance and listening enjoyment from your new Tuner. Please retain this manual for future reference.

## Contents

**Introduction** .....En-2

**Connections** ..... En-10

**Enjoying Audio Sources**..... En-16

**Appendix**  
**Troubleshooting** ..... En-37  
**Specifications** ..... En-39



## WARNING:

TO REDUCE THE RISK OF FIRE OR ELECTRIC SHOCK, DO NOT EXPOSE THIS APPARATUS TO RAIN OR MOISTURE.

## CAUTION:

TO REDUCE THE RISK OF ELECTRIC SHOCK, DO NOT REMOVE COVER (OR BACK). NO USER-SERVICEABLE PARTS INSIDE. REFER SERVICING TO QUALIFIED SERVICE PERSONNEL.



**WARNING**  
RISK OF ELECTRIC SHOCK  
DO NOT OPEN

**AVIS**  
RISQUE DE CHOC ELECTRIQUE  
NE PAS OUVRIR



The lightning flash with arrowhead symbol, within an equilateral triangle, is intended to alert the user to the presence of uninsulated "dangerous voltage" within the product's enclosure that may be of sufficient magnitude to constitute a risk of electric shock to persons.



The exclamation point within an equilateral triangle is intended to alert the user to the presence of important operating and maintenance (servicing) instructions in the literature accompanying the appliance.

## Important Safety Instructions

1. Read these instructions.
2. Keep these instructions.
3. Heed all warnings.
4. Follow all instructions.
5. Do not use this apparatus near water.
6. Clean only with dry cloth.
7. Do not block any ventilation openings. Install in accordance with the manufacturer's instructions.
8. Do not install near any heat sources such as radiators, heat registers, stoves, or other apparatus (including amplifiers) that produce heat.
9. Do not defeat the safety purpose of the polarized or grounding-type plug. A polarized plug has two blades with one wider than the other. A grounding type plug has two blades and a third grounding prong. The wide blade or the third prong are provided for your safety. If the provided plug does not fit into your outlet, consult an electrician for replacement of the obsolete outlet.
10. Protect the power cord from being walked on or pinched particularly at plugs, convenience receptacles, and the point where they exit from the apparatus.
11. Only use attachments/accessories specified by the manufacturer.
12. Use only with the cart, stand, tripod, bracket, or table specified by the manufacturer, or sold with the apparatus. When a cart is used, use caution when moving the cart/apparatus combination to avoid injury from tip-over.  

PORTABLE CART WARNING  
S3125A
13. Unplug this apparatus during lightning storms or when unused for long periods of time.
14. Refer all servicing to qualified service personnel. Servicing is required when the apparatus has been damaged in any way, such as power-supply cord or plug is damaged, liquid has been spilled or objects have fallen into the apparatus, the apparatus has been exposed to rain or moisture, does not operate normally, or has been dropped.
15. Damage Requiring Service  
Unplug the apparatus from the wall outlet and refer servicing to qualified service personnel under the following conditions:
  - A. When the power-supply cord or plug is damaged,
  - B. If liquid has been spilled, or objects have fallen into the apparatus,
  - C. If the apparatus has been exposed to rain or water,
  - D. If the apparatus does not operate normally by following the operating instructions. Adjust only those controls that are covered by the operating instructions as an improper adjustment of other controls may result in damage and will often require extensive work by a qualified technician to restore the apparatus to its normal operation,
  - E. If the apparatus has been dropped or damaged in any way, and
  - F. When the apparatus exhibits a distinct change in performance this indicates a need for service.
16. Object and Liquid Entry  
Never push objects of any kind into the apparatus through openings as they may touch dangerous voltage points or short-out parts that could result in a fire or electric shock.  
The apparatus shall not be exposed to dripping or splashing and no objects filled with liquids, such as vases shall be placed on the apparatus.  
Don't put candles or other burning objects on top of this unit.
17. Batteries  
Always consider the environmental issues and follow local regulations when disposing of batteries.
18. If you install the apparatus in a built-in installation, such as a bookcase or rack, ensure that there is adequate ventilation.  
Leave 20 cm (8") of free space at the top and sides and 10 cm (4") at the rear. The rear edge of the shelf or board above the apparatus shall be set 10 cm (4") away from the rear panel or wall, creating a flue-like gap for warm air to escape.

# Precautions

1. **Recording Copyright**—Unless it's for personal use only, recording copyrighted material is illegal without the permission of the copyright holder.
2. **AC Fuse**—The AC fuse inside the unit is not user-serviceable. If you cannot turn on the unit, contact your Onkyo dealer.
3. **Care**—Occasionally you should dust the unit all over with a soft cloth. For stubborn stains, use a soft cloth dampened with a weak solution of mild detergent and water. Dry the unit immediately afterwards with a clean cloth. Don't use abrasive cloths, thinners, alcohol, or other chemical solvents, because they may damage the finish or remove the panel lettering.

## 4. Power WARNING

BEFORE PLUGGING IN THE UNIT FOR THE FIRST TIME, READ THE FOLLOWING SECTION CAREFULLY.

AC outlet voltages vary from country to country. Make sure that the voltage in your area meets the voltage requirements printed on the unit's rear panel (e.g., AC 230 V, 50 Hz or AC 120 V, 60 Hz).

The power cord plug is used to disconnect this unit from the AC power source. Make sure that the plug is readily operable (easily accessible) at all times.

For models with [POWER] button, or with both [POWER] and [ON/STANDBY] buttons: Pressing the [POWER] button to select OFF mode does not fully disconnect from the mains.

If you do not intend to use the unit for an extended period, remove the power cord from the AC outlet. For models with [ON/STANDBY] button only: Pressing the [ON/STANDBY] button to select Standby mode does not fully disconnect from the mains.

If you do not intend to use the unit for an extended period, remove the power cord from the AC outlet.

## 5. Preventing Hearing Loss

### Caution

Excessive sound pressure from earphones and headphones can cause hearing loss.

## 6. Batteries and Heat Exposure

### Warning

Batteries (battery pack or batteries installed) shall not be exposed to excessive heat as sunshine, fire or the like.

7. **Never Touch this Unit with Wet Hands**—Never handle this unit or its power cord while your hands are wet or damp. If water or any other liquid gets inside this unit, have it checked by your Onkyo dealer.

## 8. Handling Notes

- If you need to transport this unit, use the original packaging to pack it how it was when you originally bought it.

- Do not leave rubber or plastic items on this unit for a long time, because they may leave marks on the case.
- This unit's top and rear panels may get warm after prolonged use. This is normal.
- If you do not use this unit for a long time, it may not work properly the next time you turn it on, so be sure to use it occasionally.

## For British models

Replacement and mounting of an AC plug on the power supply cord of this unit should be performed only by qualified service personnel.

### IMPORTANT

The wires in the mains lead are coloured in accordance with the following code:

Blue: Neutral

Brown: Live

As the colours of the wires in the mains lead of this apparatus may not correspond with the coloured markings identifying the terminals in your plug, proceed as follows:

The wire which is coloured blue must be connected to the terminal which is marked with the letter N or coloured black.

The wire which is coloured brown must be connected to the terminal which is marked with the letter L or coloured red.

### IMPORTANT

The plug is fitted with an appropriate fuse. If the fuse needs to be replaced, the replacement fuse must be approved by ASTA or BSI to BS1362 and have the same ampere rating as that indicated on the plug. Check for the ASTA mark or the BSI mark on the body of the fuse.

If the power cord's plug is not suitable for your socket outlets, cut it off and fit a suitable plug. Fit a suitable fuse in the plug.

## For European Models

### Declaration of Conformity

We, ONKYO EUROPE  
ELECTRONICS GmbH  
LIEGNITZERSTRASSE 6,  
82194 GROEBENZELL,  
GERMANY



declare in own responsibility, that the ONKYO product described in this instruction manual is in compliance with the corresponding technical standards such as EN60065, EN55013, EN55020 and EN61000-3-2, -3-3.

GROEBENZELL, GERMANY

K. MIYAGI

ONKYO EUROPE ELECTRONICS GmbH

# Features

---

- Clean Design Aluminum Front Panel**
- Network Capability**
  - Internet Radio
  - DLNA (Digital Living Network Alliance)
- iPod/iPhone<sup>\*1</sup> Digital Direct Connection via USB**
- USB Mass-storage Class Device Compatible USB**
- Music Optimizer<sup>\*2</sup> for Compressed Digital Music Files**
- AirPlay<sup>\*1</sup>**
- Separate Wolfson DACs (WM8742) for L/R Channels**
- 3 Digital Outputs (Optical, Coaxial and AES/EBU)**
- DIDRC<sup>\*3</sup> (Dynamic Intermodulation Distortion Reduction Circuitry)**
- Gold Plated Terminals**
- AM/FM 40 Presets**
- DAB/DAB+**
- RDS (PS/PTY/RT/TP)**
- Anti-vibration Oval Chassis**
- RI (Remote Interactive) capable**
- Display Dimmer (Normal/Dim/Dimmer)**
- Auto Standby Function**

\*1



AirPlay, the AirPlay logo, iPad, iPhone, iPod, iPod classic, iPod nano, iPod shuffle, and iPod touch are trademarks of Apple Inc., registered in the U.S. and other countries.

“Made for iPod” and “Made for iPhone” mean that an electronic accessory has been designed to connect specifically to iPod or iPhone, respectively, and has been certified by the developer to meet Apple performance standards.

Apple is not responsible for the operation of this device or its compliance with safety and regulatory standards.

Please note that the use of this accessory with iPod or iPhone may affect wireless performance.

\*2

Music Optimizer™ is a trademark of Onkyo Corporation.

\*3

DIDRC and DIDRC logo are registered trademarks of Onkyo Corporation.

# Contents

---

<b>Important Safety Instructions</b> .....	<b>2</b>	<b>Troubleshooting</b> .....	<b>37</b>
<b>Precautions</b> .....	<b>3</b>	Power .....	37
<b>Features</b> .....	<b>4</b>	Audio .....	37
<b>Supplied Accessories</b> .....	<b>6</b>	Tuner.....	37
Installing the Batteries.....	6	Remote Controller .....	37
Aiming the Remote Controller.....	6	Music Server and Internet Radio.....	37
<b>Getting to Know the Tuner</b> .....	<b>7</b>	AirPlay.....	37
Front Panel .....	7	USB Device Playback .....	38
Rear Panel .....	8	Others .....	38
Display .....	8	<b>Specifications</b> .....	<b>39</b>
Remote Controller.....	9		
<b>Connecting Antennas</b> .....	<b>10</b>		
Connecting the FM Antenna .....	10		
Connecting the AM Loop Antenna .....	10		
Connecting the DAB Antenna .....	11		
<b>Connecting Your Components</b> .....	<b>12</b>		
Before Making Any Connections.....	12		
Cable and Jacks .....	12		
About Balanced Output (AES/EBU Jack) .....	13		
Connecting to an Amplifier.....	13		
Connecting Onkyo <b>RI</b> Components.....	14		
Connecting the Power Cord .....	15		
Turning On and Standby .....	15		
<b>Listening to the Radio</b> .....	<b>16</b>		
Listening to AM/FM Stations .....	16		
Listening to DAB Digital Radio .....	19		
Using RDS .....	21		
<b>Using the USB/Network Device</b> .....	<b>23</b>		
Connecting the iPod/iPhone Directly to the USB Port.....	23		
Using the AirPlay .....	24		
Playing the USB Device.....	25		
Listening to the Internet Radio.....	26		
Playing Music Files on a Server.....	27		
Remote Playback.....	28		
<b>Network/USB Features</b> .....	<b>29</b>		
Connecting to the Network .....	29		
Network Requirements.....	29		
Server Requirements .....	29		
USB Device Requirements .....	30		
Supported Audio File Formats .....	30		
About DLNA.....	30		
<b>Advanced Setup</b> .....	<b>31</b>		
Setting the Display Brightness .....	31		
Changing the Advanced Setup Settings .....	31		
Advanced Setup Menu .....	32		
<b>Firmware Update</b> .....	<b>34</b>		
Updating the Firmware via Network.....	34		
Updating the Firmware via USB.....	35		

# Supplied Accessories

Make sure you have the following accessories:

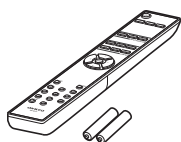

Remote controller (RC-831T) and two batteries (AAA/R03)

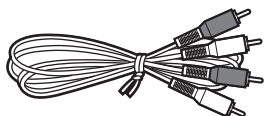

Audio cable



RI cable

To use **RI**, T-4070 must be connected with an **RI** cable.

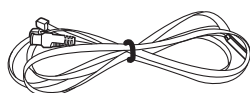

Indoor FM antenna



AM loop antenna



DAB antenna

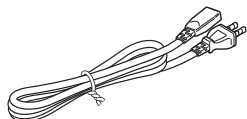

Power cord

\* In catalogs and on packaging, the letter at the end of the product name indicates the color. Specifications and operation are the same regardless of color.

## Installing the Batteries

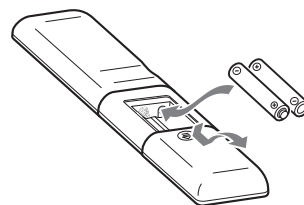

### Notes:

- If the remote controller doesn't work reliably, try replacing the batteries.
- Don't mix new and old batteries or different types of batteries.
- If you intend not to use the remote controller for a long time, remove the batteries to prevent damage from leakage or corrosion.
- Expired batteries should be removed as soon as possible to prevent damage from leakage or corrosion.

## Aiming the Remote Controller

When using the remote controller, point it toward the tuner's remote control sensor, as shown below.

Remote control sensor

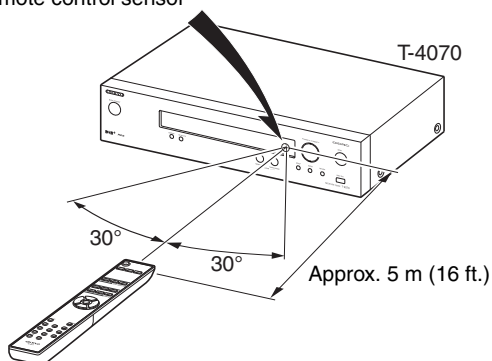

# Getting to Know the Tuner

## Front Panel

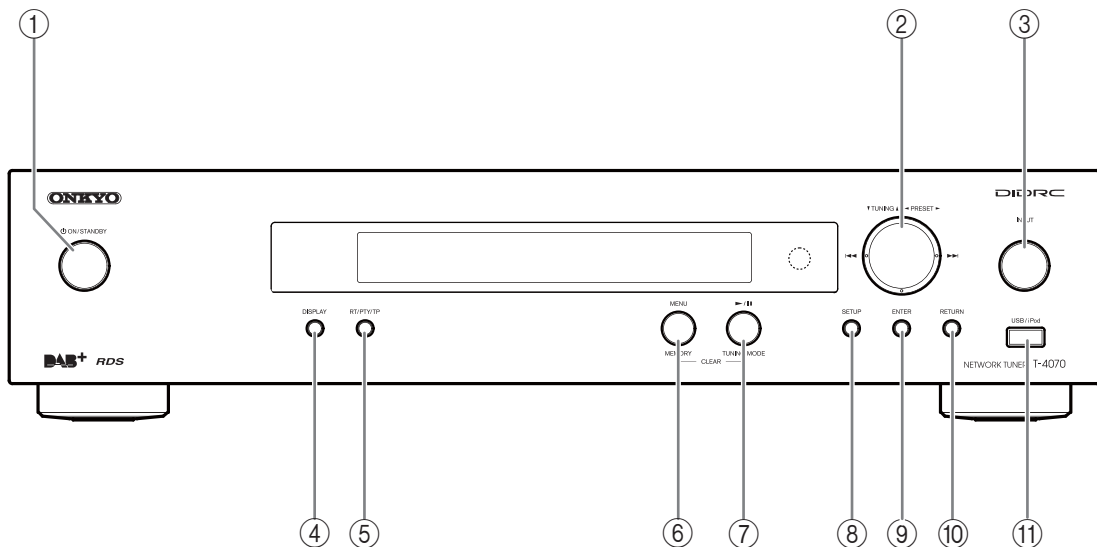

For detailed information, see the pages in parentheses.

- |  |   |
|--|---|
| ① <b>ON/STANDBY</b> button (15, 35, 36, 37)                                    | ⑥ <b>MEMORY/MENU</b> button (17, 25, 28)            |
| ② <b>TUNING</b> ▲/▼, <b>PRESET</b> ◀/▶, ◀◀/▶▶ buttons (16, 19, 22, 24, 28, 31) | ⑦ <b>TUNING MODE</b> / ▶/   button (16, 17, 20, 37) |
| ③ <b>INPUT</b> button (16, 19, 23)   | ⑧ <b>SETUP</b> button (18, 19, 20, 24, 31, 34)      |
| ④ <b>DISPLAY</b> button (19, 23, 25)   | ⑨ <b>ENTER</b> button (17, 19, 20, 24)              |
| ⑤ <b>RT/PTY/TP</b> button (22)   | ⑩ <b>RETURN</b> button (23, 27)                     |
|  | ⑪ <b>USB port</b> (23, 25)                          |

## Rear Panel

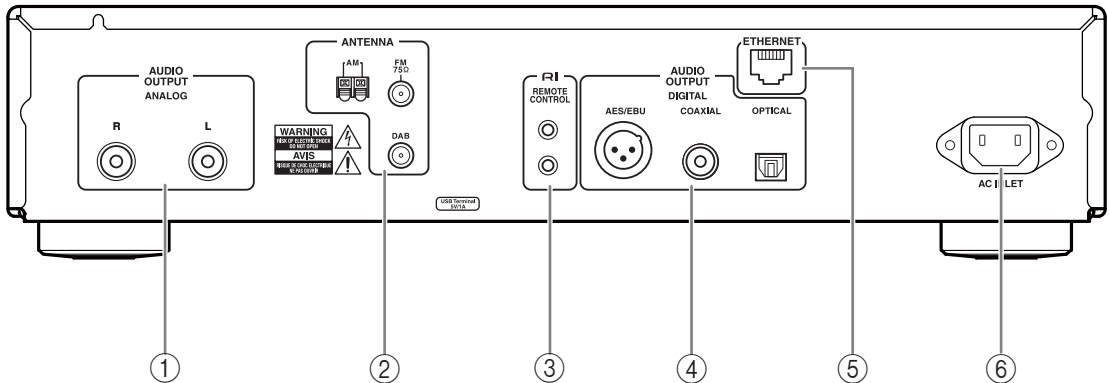

For detailed information, see the pages in parentheses.

- ① **AUDIO OUTPUT jacks (12, 13)**
- ② **FM ANTENNA jack and AM ANTENNA terminal and DAB ANTENNA jack (10, 11)**
- ③ **RI REMOTE CONTROL jack (12, 14)**
- ④ **DIGITAL OUT COAXIAL and OPTICAL and AES/EBU jacks (12, 13)**

- ⑤ **ETHERNET port (29)**
- ⑥ **AC INLET terminal (15)**

See “Connecting Antennas”, “Connecting Your Components” for connection (→ pages 10 to 15).

## Display

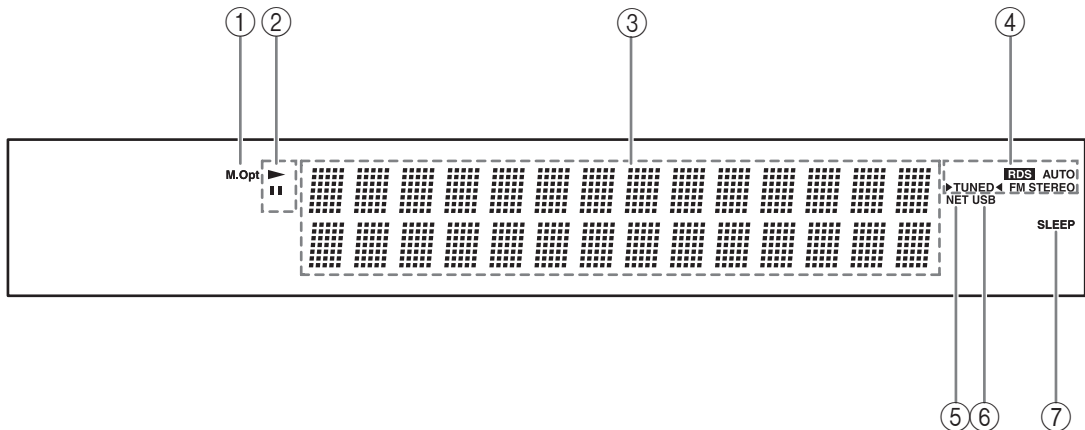

For detailed information, see the pages in parentheses.

- ① **M.Opt indicator**
- ② **▶, II indicators**
- ③ **Message area**
- ④ **Tuning indicators**
  - **RDS indicator (21)**
  - **AUTO indicator (16)**
  - **TUNED indicator (16)**
  - **FM STEREO indicator (16)**

- ⑤ **NET indicator (26)**
- ⑥ **USB indicator (23)**
- ⑦ **SLEEP indicator (24)**



## Remote Controller

For detailed information, see the pages in parentheses.

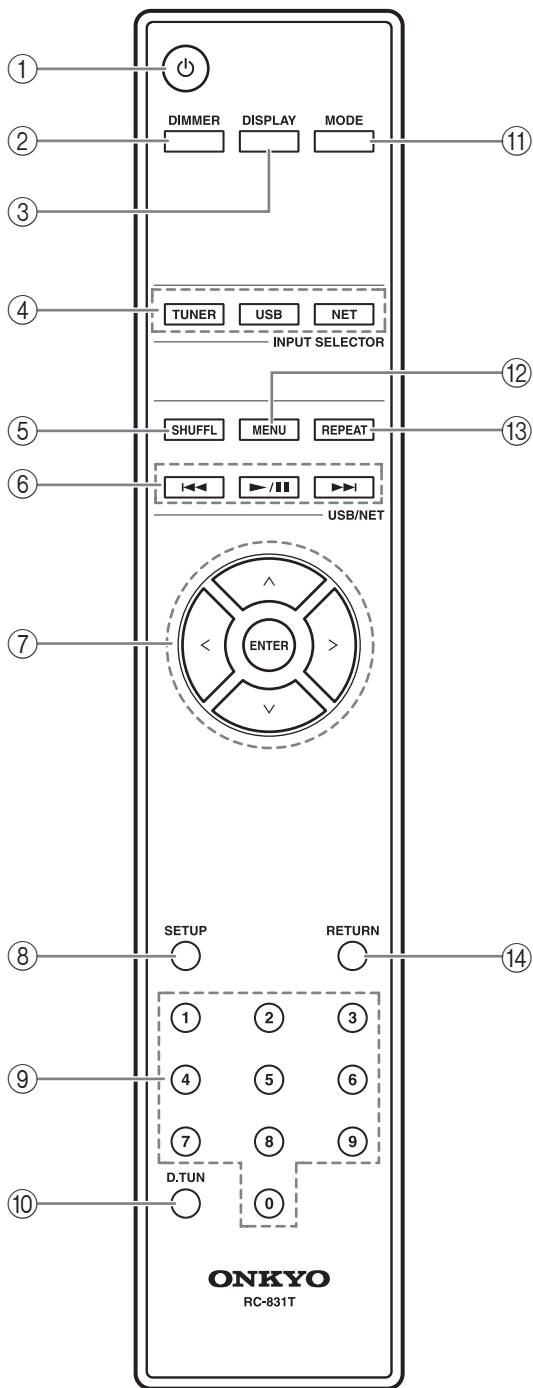

- ① ⏻ button (15)
- ② DIMMER button (31)
- ③ DISPLAY button (19, 23, 25)
- ④ INPUT SELECTOR buttons (16, 19, 23)
- ⑤ SHUFFL button (23, 24, 25)
- ⑥ Control buttons (17, 23, 25, 28)
- ⑦ Arrow [^]/[v]/[<]/[>] and ENTER buttons (16, 19, 23, 31, 34)
- ⑧ SETUP button (18, 19, 20, 24, 31, 34)
- ⑨ Number buttons (17)
- ⑩ D.TUN button (17, 18)
- ⑪ MODE button (16, 23)
- ⑫ MENU button (25, 26)
- ⑬ REPEAT button (23, 24, 25)
- ⑭ RETURN button (19, 20, 23, 27)

# Connecting Antennas

This section explains how to connect the supplied FM antenna, AM loop antenna, and DAB antenna.

The tuner won't pick up any radio signals if no antenna is connected, so you must connect the antenna to use the tuner.

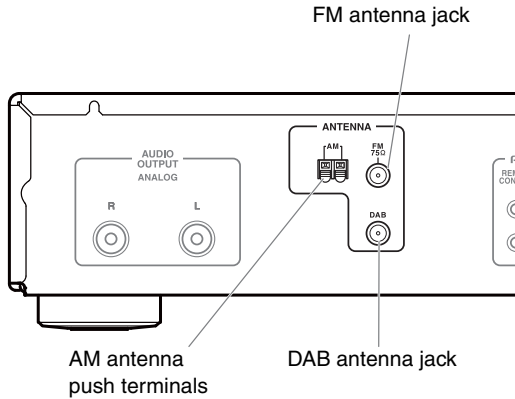

## Connecting the FM Antenna

The supplied FM antenna is for indoor use only.

### 1 Attach the FM antenna, as shown.

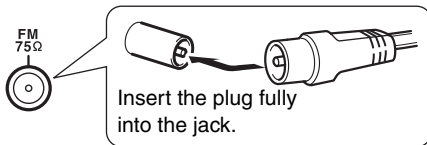

Once your tuner is ready for use, you'll need to tune into an FM radio station and adjust the position of the FM antenna to achieve the best possible reception.

### 2 Use thumbtacks or something similar to fix the FM antenna into position.

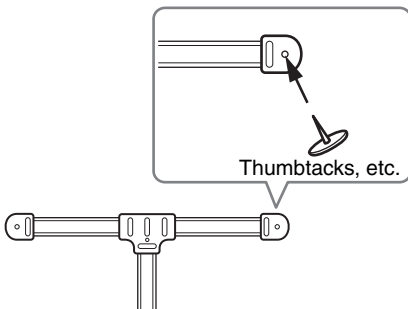

**Caution:** Be careful that you don't injure yourself when using thumbtacks.

If you cannot achieve good reception with the supplied FM antenna, try using a commercially available outdoor FM antenna instead.

## Connecting the AM Loop Antenna

The supplied AM loop antenna is for indoor use only.

### 1 Assemble the AM loop antenna, inserting the tabs into the base, as shown.

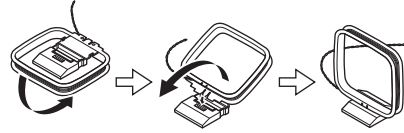

### 2 Connect both wires of the AM loop antenna to the AM push terminals, as shown.

(The antenna's wires are not polarity sensitive, so they can be connected either way around).

Make sure that the wires are attached securely and that the push terminals are gripping the bare wires, not the insulation.

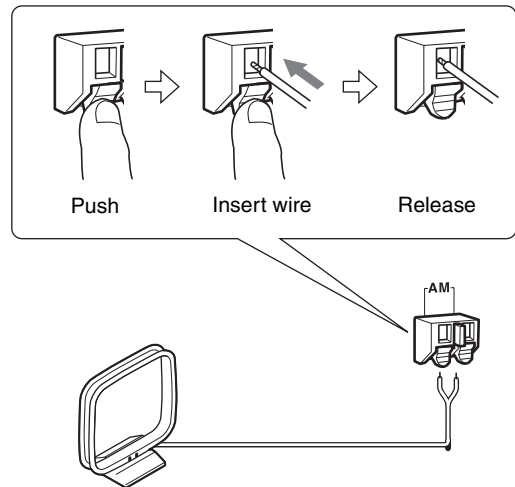

Once the your tuner is ready for use, you'll need to tune into an AM radio station and adjust the position of the AM antenna to achieve the best possible reception.

Keep the antenna as far away as possible from your tuner, TV, speaker cables, and power cords.

If you cannot achieve good reception with the supplied AM loop antenna, try using it with a commercially available outdoor AM antenna.

### Connecting the DAB Antenna

---

- 1** Screw the supplied DAB antenna's plug onto the DAB ANTENNA jack.

Once your tuner is ready for use, you'll need to tune into a DAB station and adjust the position of the DAB antenna to achieve the best possible reception.

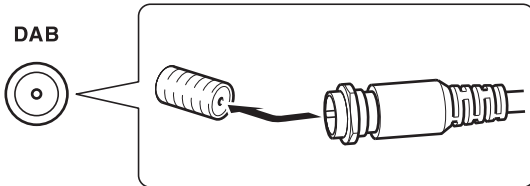

- 2** Use thumbtacks or something similar to fix the DAB antenna into position.

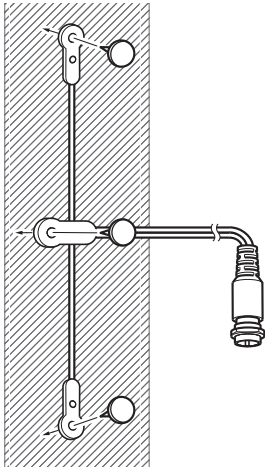







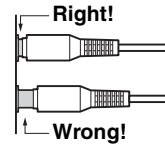



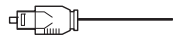

# Connecting Your Components

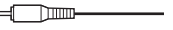
## Before Making Any Connections

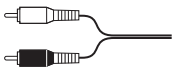
- Refer to the instructions that came with the component you are connecting.
- Do not plug in the power cord until all other connections are complete.
- Do not bind audio cables with power cords and speaker cables. Doing so may adversely affect the sound quality.
- To prevent interference, keep power cords and speaker cables as far away as possible from the antennas.
- Push each plug in all the way to make a good connection (loose connections can cause noise or malfunctions).

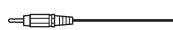

## Cable and Jacks

<p><b>Balanced AES/EBU</b></p> 	<p>AES/EBU</p> 	<p>This is a professional digital audio interface. Balanced AES/EBU cables are used for better noise immunity and longer cable runs. The maximum sampling rate for PCM output is 96kHz/24bit, 2ch.</p>
<p><b>Optical digital audio</b></p> 	<p>OPTICAL</p> 	<p>Optical digital connections allow you to enjoy digital sound such as PCM. The maximum sampling rate for PCM output is 96kHz/24bit, 2ch.</p>
<p><b>Coaxial digital audio</b></p> 	<p>COAXIAL</p>  <p>Orange</p>	<p>Coaxial digital connections allow you to enjoy digital sound such as PCM. The maximum sampling rate for PCM output is 96kHz/24bit, 2ch.</p>
<p><b>Analog audio (RCA)</b></p> 	<p>ANALOG</p> <p>R L</p>  <p>Red White</p>	<p>Analog audio connections (RCA) carry analog audio.</p>
<p><b>USB</b></p> 	<p>USB/iPod</p> 	<p>The network tuner supports high-speed USB 2.0. You can connect USB memory or iPod/iPhone.</p>
<p><b>RI</b></p> 	<p>RI REMOTE CONTROL</p> 	<p>To use <b>RI</b> (Remote Interactive), you need to connect your Onkyo AV components with an <b>RI</b> cable.</p>

## About Balanced Output (AES/EBU Jack)

The tuner's balanced AES/EBU jack is wired as shown

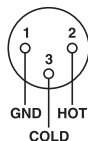

### Plugging the AES/EBU cable

Match the pins and insert the jack until you hear a “click.” Make sure that the jack is locked by lightly pulling the connection cable.

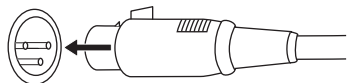

### Unplugging the AES/EBU cable

Pull out the connection cable while holding down the button.

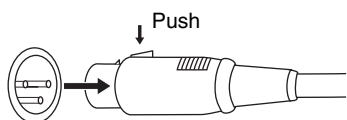

## Connecting to an Amplifier

### Analog Connection

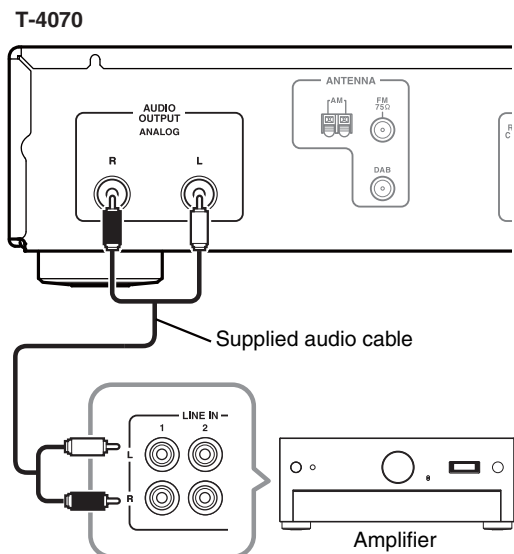

Use the supplied audio cable to connect the T-4070's AUDIO OUTPUT L/R jacks to the LINE IN jacks on your amplifier, as shown.

## Digital (Optical or Coaxial) Connection

### T-4070

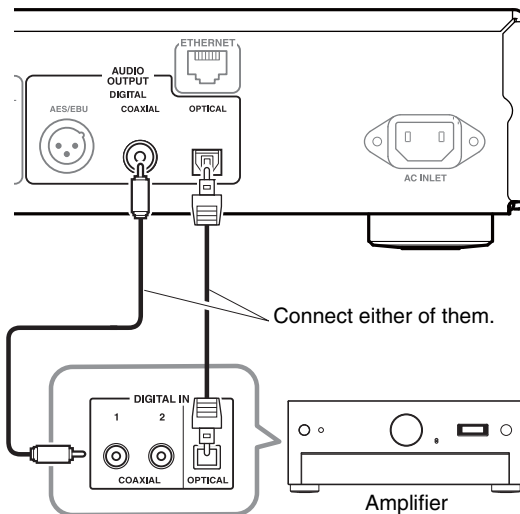

Use the digital audio cable to connect the T-4070's DIGITAL COAXIAL/OPTICAL jacks to the DIGITAL IN jacks on your amplifier, as shown.

### Digital (AES/EBU) Connection

### T-4070

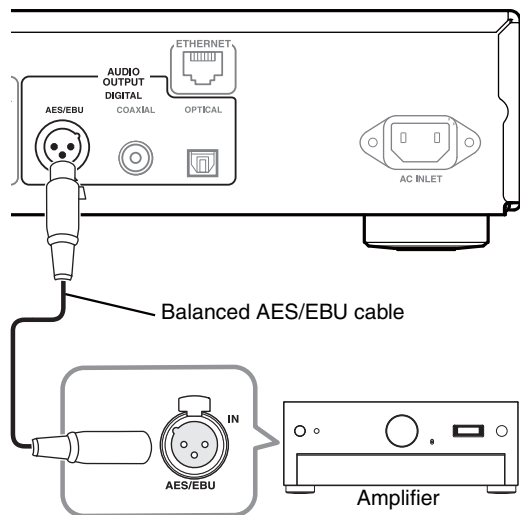

Use the balanced AES/EBU cable to connect the T-4070's DIGITAL AES/EBU jacks to the AES/EBU IN jacks on your amplifier, as shown.

## RI Connection

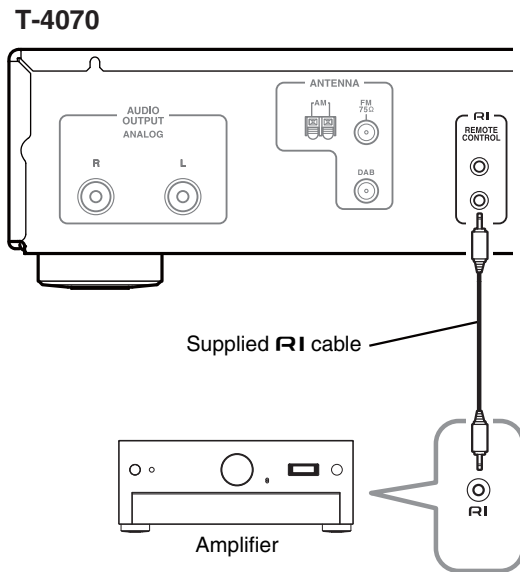

To use the **RI** system functions, use the supplied **RI** cable to make an **RI** connection (see the next column).

### Note:

- If the T-4070 is used with another Onkyo component, such as the A-9070, refer to its instruction manual as well.

## Connecting Onkyo RI Components

If you connect the T-4070 to another Onkyo **RI**-capable component with the supplied **RI** cable and audio cable, you can use the following system functions. **RI** cables are special cables solely for use with Onkyo products.

### Auto Power On

When you turn on the T-4070, your Onkyo amplifier will turn on automatically. (The amplifier's **POWER** switch must be set to **ON** for this to work.)

### Direct Change

When you select a radio preset or change the band (AM, FM, DAB), your Onkyo amplifier will automatically select the T-4070 as the input source.

### Remote Control Operation

You can control the T-4070 by using your Onkyo amplifier's remote controller. See the amplifier's instruction manual for details.

With **RI** (Remote Interactive), you can control your **RI**-capable Onkyo CD player, T-4070, and so on with your amp's remote controller.

Onkyo amplifier  
(A-9070), etc.

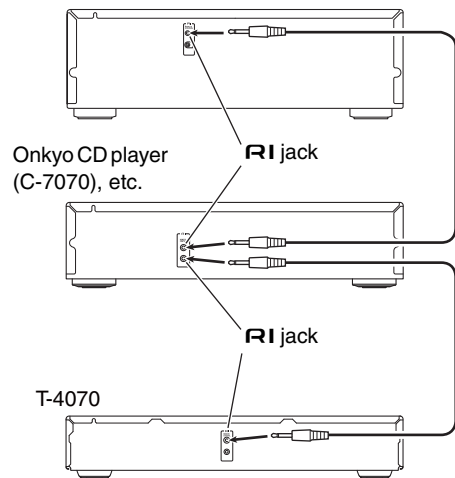

### Notes:

- Push each plug in all the way to make a good connection.
- Use only dedicated **RI** cables for **RI** connections. **RI** cables are supplied with Onkyo tuners and players (DVD, CD, etc.).
- Some components, including the T-4070, have two **RI** jacks. They're both the same, so use either one.
- **RI** jacks should be connected only to Onkyo components.
- Connecting them to another manufacturer's component may cause a malfunction.
- Some components may not support all **RI** functions. See the manuals supplied with your other Onkyo components for more information.

### Connecting the Power Cord

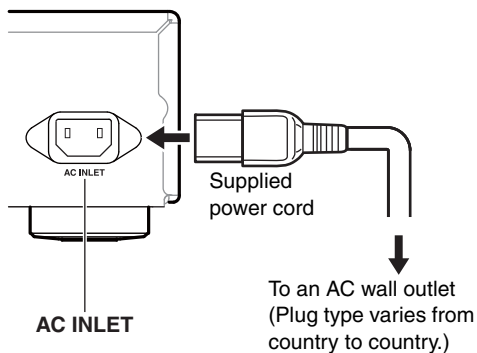

- 1** Connect all of your speakers and AV components.
- 2** Connect the supplied power cord to the network tuner's AC INLET.
- 3** Plug the power cord into an AC wall outlet.

### Turning On and Standby

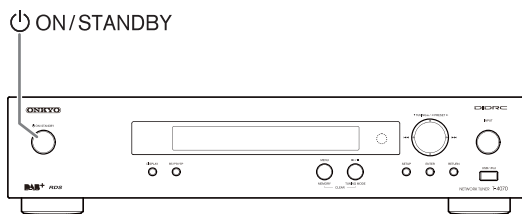

- 1** Press the [**ON/STANDBY**] button. Alternatively, press the remote controller's [**ON/STANDBY**] button.

The tuner comes on, and the display lights up.

To turn the tuner off, press the [**ON/STANDBY**] button, or press the remote controller's [**ON/STANDBY**] button. The tuner will enter Standby mode.

# Listening to the Radio

## Listening to AM/FM Stations

With the built-in tuner, you can enjoy AM and FM radio stations.

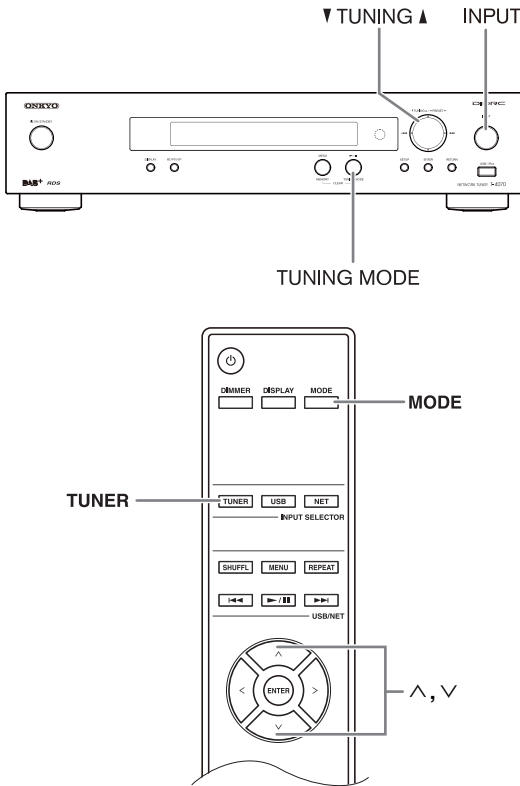

- 1 Use the tuner's [INPUT] button, or the remote controller's [TUNER] button to select AM or FM.

In this example, FM has been selected.

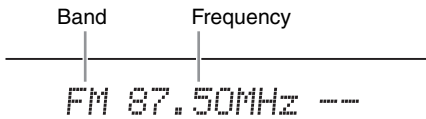

(Actual display depends on the country.)

- 2 Press the [TUNING MODE] button or the remote controller's [MODE] button so that the AUTO indicator appears or disappears from the display.

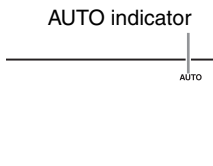

### Auto Tuning

To activate this mode, press the [TUNING MODE] button to turn on the "AUTO" indicator. In this mode, you will receive the broadcast in stereo sound.

### Manual Tuning

To activate this mode, press the [TUNING MODE] button to turn off the "AUTO" indicator. In this mode, you will receive the broadcast in monaural sound.

- 3 Press the TUNING [▲] or [▼] button.

You can also use the remote controller's arrow [▲]/[▼] buttons to tune the radio.

### Auto Tuning

Searching stops when a station is found.

### Manual Tuning

The frequency stops changing when you release the button.

Press the buttons repeatedly to change the frequency one step at a time.

The frequency changes in 0.05 MHz steps for FM, and 9 kHz (or 10 kHz) steps for AM.

When tuned to a station, the TUNED indicator appears. When tuned to a stereo FM station, the FM STEREO indicator also appears.

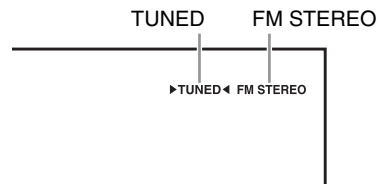

### Tuning to Weak FM Stereo Stations

If the signal from a stereo FM station is weak, it may be impossible to get good reception. In this case, switch to Manual Tuning mode and listen to the station in mono.



## ■ Tuning into Stations by Frequency

You can tune to AM and FM stations directly by entering the appropriate frequency.

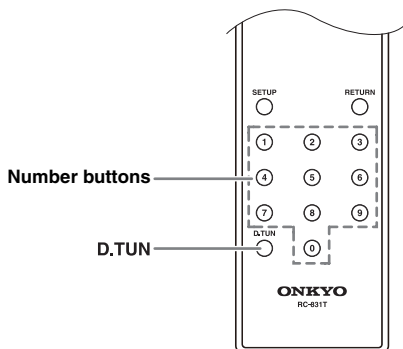

- 1 Press the remote controller's [D.TUN] button.



(Actual display depends on the country.)

- 2 Within 8 seconds, use the number buttons to enter the frequency of the radio station.

For example, to tune to 87.50 (FM), press 8, 7, 5, 0.

## Presetting AM/FM Stations

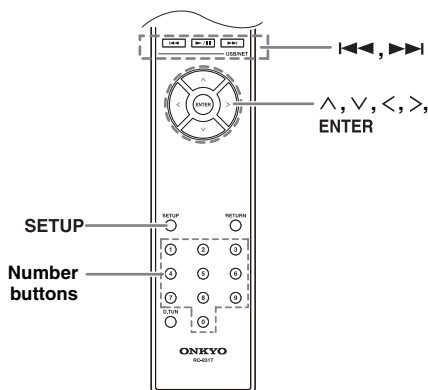
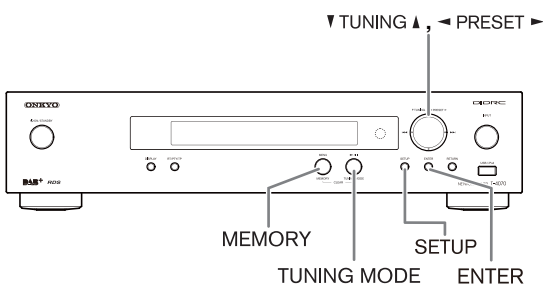

You can store up to 40 of your favorite AM/FM radio stations as presets.

Presetting FM/AM stations is performed by the tuner.

- 1 Tune to the AM/FM station that you want to store as a preset.

- 2 Press the [MEMORY] button.

The preset number flashes.



(Actual display depends on the country.)

- 3 While the preset number flashes (about 8 seconds), use the PRESET [◀]/[▶] buttons to select a preset from 1 through 40.

- 4 Press the [MEMORY] button again to store the station or channel.

The station or channel is stored and the preset number stops flashing.

Repeat this procedure for all of your favorite AM/FM radio stations.

## ■ Selecting Presets

To select a preset, use the number buttons on the remote controller, the remote controller's arrow [◀◀]/[▶▶] buttons or the tuner's PRESET [◀]/[▶] buttons.

## ■ Deleting Presets

- 1 Select the preset that you want to delete.

See the previous section.

- 2 While holding down the [MEMORY] button, press the [TUNING MODE] button.

The preset is deleted and its number disappears from the display.

**■ Name Edit**

You can enter a custom name for radio preset for easy identification. When entered, the custom name will appear on the display.

The custom name is edited using the character input screen.

**1** Tune to the station of the preset number for which you want to edit the name, and then press the [SETUP] button.

**2** Use the arrow [^]/[v] button to select “1. Hardware Setup,” and then press [ENTER].

**3** Use the arrow [^]/[v] button to select “Name Edit,” and then press [ENTER].

**4** Use the arrow [^]/[v]/[<]/[>] button to select a character, and then press [ENTER]. Repeat this step to enter up to 10 characters.

```
<#>
#bcdefghijklm
```

**5** When you’ve finished editing the name and want to store it, be sure to use the arrow [^]/[v]/[<]/[>] button to select “OK” and then press [ENTER]. If you fail to do this, the name won’t be saved.

```
<favorite01>
Shift←→BS OK
```

- Characters are categorized into two groups: character set 1 primarily for lower case letters, and character set 2 primarily for upper case letters. You can select characters in each character set by pressing the [^]/[v] buttons. Press the [<]/[>] buttons to select a character to input, and then press the [ENTER] button to confirm. If you do not find a character that you want to select in the currently-displayed character set, press the [^]/[v] buttons to display string “Shift ← → BS OK”, use the [<]/[>] buttons to select “Shift”, and then press the [ENTER] button to display the other character set.

- The following table shows available characters.

1

a	b	c	d	e	f	g	h	i	j	k	l	m	
n	o	p	q	r	s	t	u	v	w	x	y	z	
1	2	3	4	5	6	7	8	9	0	-	=	`	
{	}	!	:	"	<	>	?	S	p	a	c	e	
S	h	i	f	t	<	-	-	>	B	S		O	K

2

A	B	C	D	E	F	G	H	I	J	K	L	M	
N	O	P	Q	R	S	T	U	V	W	X	Y	Z	
!	@	#	\$	%	^	&	*	(	)	_	+	~	
[	]	\	;	'	,	.	/	S	p	a	c	e	
S	h	i	f	t	<	-	-	>	B	S		O	K

The meaning of commands other than alphabetical characters, numbers and symbols is as follows:

**Space:**

Enters a space character.

**Shift\*1:**

Switches the displayed character.

**←(Left)/→(Right):**

Select these to move the cursor within the Name input area.

**BS (Back Space)\*2:**

Deletes the character to the left of the cursor.

**OK:**

Specifies that the entry is complete.

**Tips:**

- \*1 You can also perform this on the remote controller by using [DIMMER].
- \*2 Press [D.TUN] button to clear all characters you entered.

**Notes:**

- This procedure can also be performed on the tuner by using [SETUP], TUNING [▲]/[▼], PRESET [◀]/[▶], and [ENTER].
- Press [RETURN] to return to the previous menu.

### Listening to DAB Digital Radio

With the built-in tuner, you can enjoy DAB digital radio.

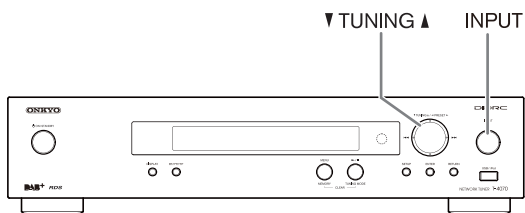

- 1 Press the tuner's [INPUT] button, or the remote controller's [TUNER] button to select "DAB".

DAB

When tuned into a DAB station, the station name will be displayed.

BBC5Live

- 2 Use the TUNING [▲]/[▼] buttons to select the DAB stations.

You can also use the remote controller's arrow [▲]/[▼] buttons to selected DAB stations.

### Selecting DAB for the Very First Time

The very first time you select DAB, the Auto Tuning function automatically scans the DAB Band III for the multiplexes (i.e., stations) available in your area. Once the scanning process is complete, the first station that was detected is selected.

### Using the Scan Function Manually

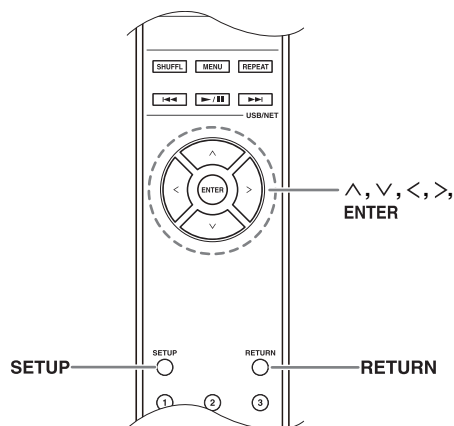

- 1 Press the [SETUP] button.
- 2 Use the arrow [▲]/[▼] button to select "1.Hardware Setup" and then press [ENTER].
- 3 Use the arrow [▲]/[▼] button to select "1.DAB Scan?" and then press [ENTER].
- 4 Use the arrow [◀]/[▶] button to select "WW" or "UK", (see "DAB Scan?" on page 20), and then press [ENTER] to start Auto Tuning function.

To cancel Auto Tuning, press the [ENTER] button. If no station is detected after scanning, "No Station" appears on the display.

### Notes:

- This procedure can also be performed on the receiver by using [SETUP], TUNING [▲]/[▼], PRESET [◀]/[▶], and [ENTER].
- Press [RETURN] to return to the previous step.

### Displaying DAB Radio Information

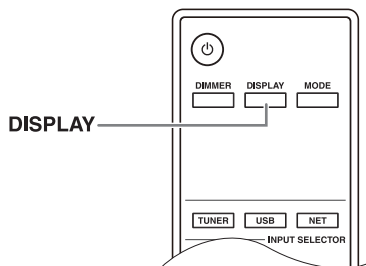
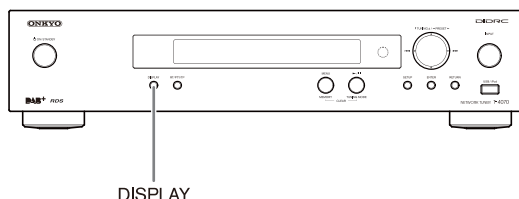

Press the [DISPLAY] button repeatedly to display more information about the selected DAB station.

### 1. DLS (Dynamic Label Segment)

When tuned to a station that's broadcasting DLS text data, the text will scroll across the display.

BBC5Live  
All the late

## 2. Program Type

Displays the type of program.

```
BBC5Live>
News
```

## 3. Bit Rate and Audio Mode

Displays the station's bit rate and audio mode (stereo, mono, or joint stereo).

```
BBC5Live>
80kbs Mono
```

## 4. Signal Quality

Displays the signal quality.

0–59: Poor reception

60–79: Good reception

80–100: Excellent reception

```
BBC5Live>
Quality: 86
```

## 5. Multiplex Name

Displays the name of the current multiplex.

```
BBC5Live>
BBC DAB
```

## 6. Multiplex Number and Frequency

Displays the number and frequency of the current multiplex.

```
BBC5Live>
12B 225.6MHz
```

## DAB Setup

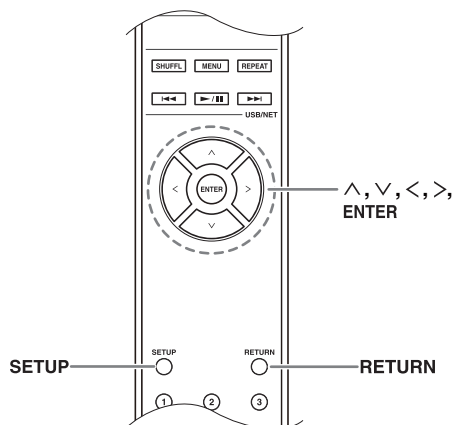

Use the following functions and settings to set up DAB digital radio.

**1** Press the [SETUP] button.

**2** Use the arrow [^]/[v] button to select “1.Hardware Setup” and then press [ENTER].

**3** Use the arrow [^]/[v] button to select the item you want to set.

The items are explained below.

### ■ DAB Scan?

This setting determines which DAB bands are scanned by the Auto Tuning function (see page 19).

**UK:** Band III (11B–12D).

**World (default):**

Band III (5A–13F) and L-Band (LA–LW).

### ■ DAB DRC?

With the DRC (Dynamic Range Control) setting, you can reduce the dynamic range of DAB digital radio so that you can still hear quiet parts even when listening at low volume levels—ideal for listening to the radio late at night when you don't want to disturb anyone.

Use the arrow [<]/[>] buttons to select the following options, and then press [ENTER].

**0 (default):** DRC off.

**1:** Large reduction in dynamic range.

**1/2:** Small reduction in dynamic range.

### Notes:

- This procedure can also be performed on the receiver by using [SETUP], TUNING [▲]/[▼], PRESET [◀]/[▶], and [ENTER].
- Press [RETURN] to return to the previous menu.

## DAB Tuning Mode

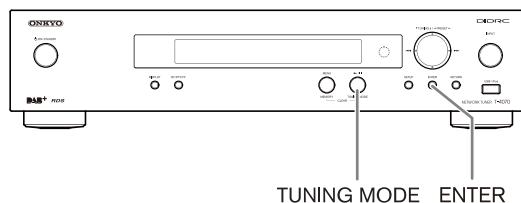

**1** Press the [TUNING MODE] button.

**2** The items toggle in the order of “Alphabet” → “Multiplex” → “Active St” each time the [TUNING MODE] button is pressed.

With this setting, you can sort the available stations alphabetically, by multiplex, or active stations.

**Alphabet (default):**

Sort stations alphabetically.

**Multiplex:** Sort stations by multiplex.

**Active St:** Sort by active stations. Receivable stations appear at the top of the list. stations that cannot be received properly appear at the bottom of the list.

## Using RDS

RDS only works in areas where RDS broadcasts are available. When tuned into an RDS station, the RDS indicator appears.

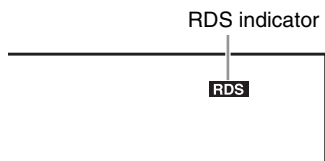

### ■ What is RDS?

RDS stands for Radio Data System and is a method of transmitting data embedded in FM radio signals. It was developed by the European Broadcasting Union (EBU) and is available in most European countries. Many FM stations use it these days. In addition to displaying text information, RDS can also help you find radio stations by type (e.g., news, sport, rock, etc.).

The tuner supports four types of RDS information:

#### PS (Program Service)

When tuned to an RDS station that's broadcasting PS information, the station's name will be displayed.

#### RT (Radio Text)

When tuned to an RDS station that's broadcasting text information, the text will be shown on the display (→ page 22).

#### PTY (Program Type)

This allows you to search for RDS radio stations by type (→ page 22).

#### TP (Traffic Program)

This allows you to search for RDS radio stations that broadcast traffic information (→ page 22).

#### Notes:

- In some cases, the text characters displayed on the tuner may not be identical to those broadcast by the radio station. Also, unexpected characters may be displayed when unsupported characters are received. This is not a malfunction.
- If the signal from an RDS station is weak, RDS data may be displayed intermittently or not at all.

### ■ Switching the Display

When receiving RDS, you can press [RT/PTY/TP] button to switch the information shown in the display.

## RDS Program Types (PTY)

Type	Display
None	NONE
News reports	NEWS
Current affairs	AFFAIRS
Information	INFO
Sport	SPORT
Education	EDUCATE
Drama	DRAMA
Culture	CULTURE
Science and technology	SCIENCE
Varied	VARIED
Pop music	POP M
Rock music	ROCK M
Middle of the road music	EASY M
Light classics	LIGHT M
Serious classics	CLASSICS
Other music	OTHER M
Weather	WEATHER
Finance	FINANCE
Children's programmes	CHILDREN
Social affairs	SOCIAL
Religion	RELIGION
Phone in	PHONE IN
Travel	TRAVEL
Leisure	LEISURE
Jazz music	JAZZ
Country music	COUNTRY
National music	NATION M
Oldies music	OLDIES
Folk music	FOLK M
Documentary	DOCUMENT
Alarm test	TEST
Alarm	ALARM

### Displaying Radio Text (RT)



When tuned to an RDS station that's broadcasting text information, the text can be displayed.

#### 1 Press the [RT/PTY/TP] button once.

The RT information scrolls across the display.

##### Notes:

- The message "Waiting" may appear while the tuner waits for the RT information.
- If the message "No Text Data" appears on the display, no RT information is available.

### Finding Stations by Type (PTY)

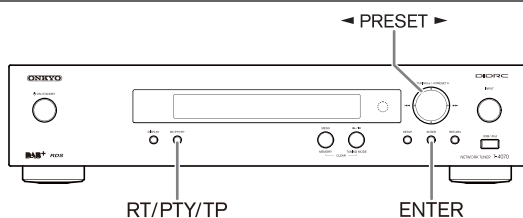

You can search for radio stations by type.

#### 1 Press the [RT/PTY/TP] button twice.

The current program type appears on the display.

#### 2 Use the PRESET [◀]/[▶] buttons to select the type of program you want.

See the table on page 21.

#### 3 To start the search, press [ENTER].

The tuner searches until it finds a station of the type you specified, at which point it stops briefly before continuing with the search.

#### 4 When a station you want to listen to is found, press [ENTER].

If no stations are found, the message "Not Found" appears.

### Listening to Traffic News (TP)

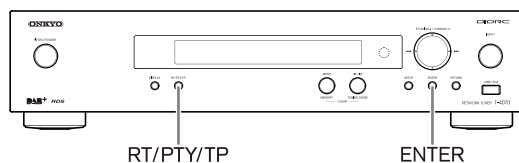

You can search for stations that broadcast traffic news.

#### 1 Press the [RT/PTY/TP] button three times.

If the current radio station is broadcasting TP (Traffic Program), "[TP]" will appear on the display. If "TP" without square brackets appears, this means that the station is not broadcasting TP.

#### 2 To locate a station that is broadcasting TP, press [ENTER].

The tuner searches until it finds a station that's broadcasting TP.

If no stations are found, the message "Not Found" appears.

# Using the USB/Network Device

## Connecting the iPod/iPhone Directly to the USB Port

USB can be used to play music files stored on iPod/iPhone, which can be plugged into the tuner's USB port.

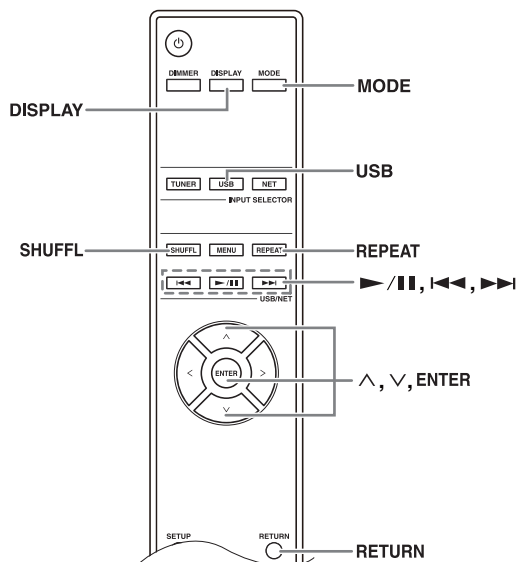
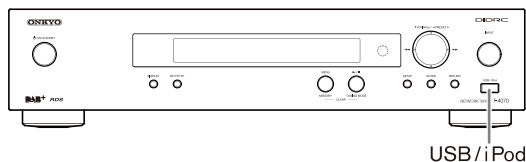

## Playing Music Files on the iPod/iPhone

This section explains how to play music files on the iPod/iPhone.

Compatible iPod/iPhone models

Made for:

iPod touch (1st, 2nd, 3rd and 4th generation),  
iPod classic,  
iPod nano (2nd, 3rd, 4th, 5th and 6th generation),  
iPhone 4, iPhone 3GS, iPhone 3G, iPhone

### 1 Press [USB] button to select the USB input.

### 2 Connect the USB cable that comes with the iPod/iPhone to the USB port at the front of the tuner.

- The USB appears in the display if the tuner is able to read the iPod/iPhone.
- The USB flashes if the tuner cannot read the iPod/iPhone.

### 3 Press [MODE] to switch to Extended Mode\*<sup>1</sup>.

You can also switch modes by pressing and holding down the tuner's [TUNING MODE] button.

A list of your iPod model's contents appears. To open a folder, use [^]/[v] to select it, and then press [ENTER].

- With the default settings, the iPod/iPhone can be manipulated as Standard Mode.
- Pressing [MODE] again switches back to Standard Mode.

### 4 Use [^]/[v] to select a music file, and press [ENTER] or [▶/||] to start playback.

- To return to the previous menu during playback, press [RETURN].
- To stop or pause playback, press [▶/||], respectively.
- To select the next song, press [▶▶▶]. To select the beginning of the current song, press [◀◀◀]. To select the previous song, press [◀◀◀] twice.
- To fast forward the current song, hold down [▶▶▶]. To fast reverse the current song, hold down [◀◀◀].
- To switch the repeat mode, press [REPEAT]. To switch the shuffle mode, press [SHUFFL]. If you reconnect the iPod/iPhone, it returns to the iPod/iPhone setting.
- You cannot use repeat mode and random mode at the same time.
- To switch displays, press the [DISPLAY] button. Press the button repeatedly to display in turn strings of information for the currently-playing song (such as, artist name, album title, playback elapsed time, song duration, etc.).

#### ■ Standard Mode control

The content information is not displayed on the tuner's display, but can be manipulated using the iPod/iPhone or the Remote Controller.

#### Note:

For video, only the audio will be output.

#### ■ Extended Mode control

The content information is displayed (lists are displayed) on the tuner's display, and you can select and manipulate the content while looking at the tuner's display.

Use the [^]/[v] buttons to display one of the following pieces of information about the content:

Playlists, Artists, Albums, Genres, Songs, Composers, Shuffle Songs, Now Playing

\*1 When you disconnect the iPod/iPhone, the tuner stores the mode. This means that if you disconnect when in Extended Mode, the tuner will start in Extended Mode when you next connect the iPod/iPhone.

### Using the AirPlay

With this unit, you can enjoy the music of iOS-based devices or iTunes music library using Apple Inc.'s AirPlay.

#### Note:

To use AirPlay, you will need one of the following equipments.

- iPad, iPhone, iPod touch with iOS 4.2 or greater.
- A personal computer with iTunes 10 (or greater) installed.

#### Tip:

For optimal performance, we recommend you always use the latest version of iOS and iTunes.

For details on AirPlay or how to obtain the latest version for your software, please visit Apple web site.

### Network Setup

---

#### 1 Connect the T-4070 to your router with an Ethernet cable.

See: “Network/USB Features” (→ page 29).

#### 2 Set the T-4070 power to on.

---

### Playback

---

Follow the procedure below to play back.

#### 1 Use the tuner's [INPUT] button or the remote controller's [NET] button to select “AirPlay”.

When AirPlay is connected and ready, the tuner displays “No Source.”

#### 2 Select “T-4070” (default name) with the AirPlay icon of iTunes or on your iPad/iPhone/iPod touch device.

Make sure that “No Source” is still displayed on the unit, then operate iTunes or your iPad/iPhone/iPod touch.

#### 3 Select a song to play back.

You can perform the following operations during AirPlay playback:

- To stop or pause playback, press [▶/II], respectively.
- To select the next song, press [▶▶I]. To select the beginning of the current song, press [I◀◀]. To select the previous song, press [I◀◀] twice.
- To switch the repeat mode, press [REPEAT]. To switch the shuffle mode, press [SHUFFL].

- To switch displays, press the [DISPLAY] button. Press the button repeatedly to display in turn strings of information for the currently-playing song (such as, artist name, album title, playback elapsed time, song duration, etc.).

#### Tips:

- When iTunes or your iPad/iPhone/iPod touch device is not detected (no connection via AirPlay), “No Source” is displayed on the Tuner.
- The operations described above may vary depending on the version of iOS and iTunes.
- For detailed information on iTunes, see the Help section of iTunes.

### SetUp

---

#### 1 Use the tuner's [INPUT] button or the remote controller's [NET] button to select “AirPlay”.

#### 2 Press the [SETUP] button on the remote controller.

#### 3 Use the arrow [^]/[v] buttons to select “1. Hardware Setup,” and then press [ENTER].

#### 4 Use the arrow [^]/[v] buttons to select the item you want to set.

#### 5 Use the arrow [<]/[>] buttons to switch between [On]/[Off].

##### Auto Select

The Tuner's “AirPlay” selector is automatically selected upon AirPlay playback.

- ▶ On (default)
- ▶ Off

##### Wake Up On AirPlay

Even when the tuner is in standby mode, it can be turned on by AirPlay playback.

- ▶ On
- ▶ Off (default)

#### Note:

- When this function is set to “On”, the SLEEP indicator is dimly-lit and the standby power consumption of the tuner increases.
- If you set this function to “On”, the “Auto Select” setting is automatically turned “On”.

#### Note:

- This procedure can also be performed on the tuner by using [SETUP], TUNING [▲]/[▼], PRESET [◀]/[▶], and [ENTER].



- Press [RETURN] to return to the previous menu.

### Playing the USB Device

This section explains how to play music files from a USB device (e.g., USB flash drives and MP3 players). See also: “Network/USB Features” (→ page 29).

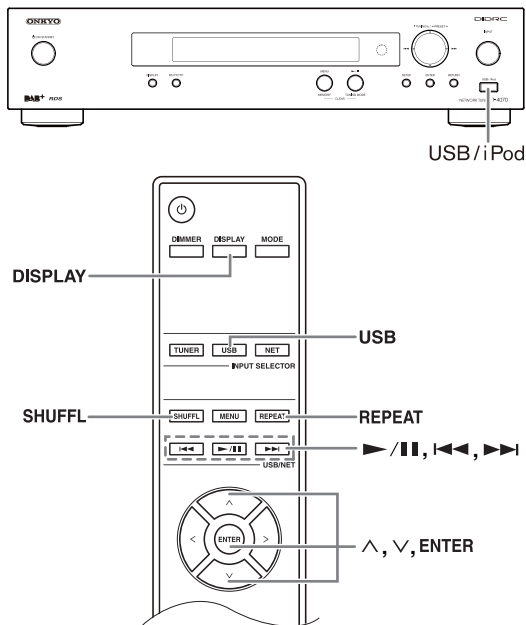

- To switch displays, press the [DISPLAY] button. Press the button repeatedly to display in turn strings of information for the currently-playing song (such as, artist name, album title, playback elapsed time, song duration, etc.).
- Press and hold down the tuner’s [MENU] button to return to the first menu.

#### Notes:

- If the media you connect is not supported, the message “No Storage” will appear on the display.
- If you connect a USB hard disk drive to the tuner’s USB port, we recommend that you use its AC adapter to power it.
- The tuner supports USB MP3 players that support the USB Mass Storage Class standard, which allows USB devices to be connected to computers without the need for special drivers or software. Note that not all USB MP3 players support the USB Mass Storage Class standard. Refer to your USB MP3 player’s instruction manual for details.
- Protected WMA music files on an MP3 player cannot be played.
- Onkyo accepts no responsibility whatsoever for the loss or damage to data stored on a USB device when that device is used with the tuner. We recommend that you back up your important music files beforehand.
- MP3 players containing music files that are managed with special music software are not supported.
- Operation is not guaranteed for all USB devices, which includes the ability to power them.
- Do not connect your USB device via a USB hub. The USB device must be connected directly to the tuner’s USB port.
- If the USB device contains a lot of data, the tuner make take a while to read it.
- USB devices with security functions cannot be played.
- Do not disconnect the USB device or USB cable that comes with iPod/iPhone to the USB port at the front of the tuner, while the message “Connecting...” appears on the display.

### 1 Press [USB] button to select the “USB” input.

You can also select the USB input by pressing the tuner’s [INPUT] button.

### 2 Plug your USB device into the tuner’s USB port.

The USB appears in the display. It will flash if the tuner cannot read the USB device.

### 3 Press [ENTER].

A list of the device’s contents appears. To open a folder, use [^]/[v] to select it, and then press [ENTER].

### 4 Use [^]/[v] to select a music file, and press [ENTER] or [▶/||] to start playback.

- To stop or pause playback, press [▶/||], respectively.
- To select the next song, press [▶▶]. To select the beginning of the current song, press [◀◀]. To select the previous song, press [◀◀] twice.
- To fast forward the current song, hold down [▶▶]. To fast reverse the current song, hold down [◀◀].
- To switch the repeat mode, press [REPEAT]. To switch the random mode, press [SHUFFL].

### Listening to the Internet Radio

You need to connect the tuner to your home network; see “Network/USB Features” (→ page 29)

You can select Internet radio stations by connecting to the tuner from your computer and selecting stations in your web browser.

Internet radio URLs in the following formats are supported: PLS, M3U, and podcast (RSS). However, depending on the type of data or audio format used by the Internet radio station, you may not be able to listen to some stations.

#### Note:

Services available may vary depending on the region.

This tuner features a list of various radio stations. This section’s explanation uses vTuner Internet Radio as an example.

See the separate instructions for more information.

### Listening to vTuner Internet Radio

This unit includes the full vTuner Internet Radio Service at no additional charge. Once you have connected your unit to the Internet, you can select vTuner Internet Radio to search for and play Internet radio stations and podcasts at any time. To enhance your Internet radio experience, the <http://onkyo.vtuner.com/> portal is available to you as an easy way to browse to find stations, set up/organize your favorites, add your own stations, get help, etc. After the first time you try vTuner Internet Radio on your unit you can use the MAC Address of your unit to create a member login account (email address and password) on the <http://onkyo.vtuner.com/> portal. To verify your MAC Address, please see “Network Setup” (→ page 32).

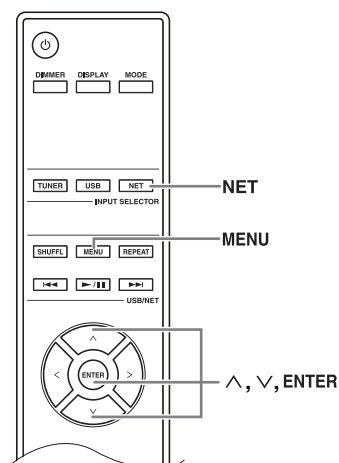

#### 1 Press [NET] button.

The “NET” appears on the display and the NET indicator lights. If it flashes, verify that the Ethernet cable is firmly connected to the tuner.

#### 2 Use [^]/[v] to select “vTuner Internet Radio” and then press [ENTER].

#### 3 Use [^]/[v] to select a folder and then press [ENTER].

#### 4 Use [^]/[v] to select a program and then press [ENTER].

Playback starts.

Press [MENU] button to enable selection from the following menu items.

##### ► Stations like this:

Stations like the one currently being played back are displayed.

##### ► Add to My Favorites:

Adds a station to My Favorites list.

You can preset up to 40 internet radio stations.

### Listening to Other Internet Radio

To listen to other internet radio stations, register the programs in the “My Favorites” following steps below.

#### 1 Press [NET] button.

The “NET” appears on the display and the NET indicator lights. If it flashes, verify that the Ethernet cable is firmly connected to the tuner.

#### 2 On your computer, start your web browser and enter the tuner’s IP address in the browser’s Internet address (URL) field.

The browser connects to the tuner (WEB Setup Menu).

#### Notes:

- The tuner’s IP address is shown on “IP Address” (→ page 32).
- If you’re using DHCP, your router may not always allocate the same IP address to the tuner, so if you find that you can’t connect to the tuner, recheck the tuner’s IP address on the “Network Setup” display.

#### 3 Click on the “My Favorites” tab.

#### 4 Enter the preset name and Internet address (URL).

#### 5 Click “Save” to save the Internet radio station.

#### 6 The Internet radio station is then added to “My Favorites”.

### Listening to the Preset Stations Registered in “My Favorites”

#### 1 Press [NET] button.

The “NET” appears on the display and the NET indicator lights. If it flashes, verify that the Ethernet cable is firmly connected to the tuner.

#### 2 Use [^]/[v] to select “My Favorites”, and then press [ENTER].

#### 3 Use [^]/[v] to select a program and then press [ENTER].

Playback starts.

Press [MENU] button to enable selection from the following menu items.

► Create new station:

Add a favorite station or Internet radio to the presets.

► Rename this station:

You can rename the preset.

► Delete from My Favorites:

This will delete the preset.

### Playing Music Files on a Server

You need to connect the tuner to your home network, see “Network/USB Features” (→ page 29)

This section explains how to play music files on a computer or media server through the tuner (Server Playback).

#### Setting Up a Network Server

This section explains how to configure Windows Media Player 11/12 so that the tuner can play the music files stored on your computer.

##### ■ Windows Media Player 11 Setup

#### 1 Start Windows Media Player 11.

#### 2 On the “Library” menu, select “Media Sharing”.

The “Media Sharing” dialog box appears.

#### 3 Select the “Share my media” check box, and then click “OK”.

#### 4 Select the tuner in the list, and then click “Allow”.

#### 5 Click “OK” to close the dialog box.

This completes the Windows Media Player 11 configuration.

You can now play the music files in your Windows Media Player 11 library through the tuner.

Windows Media Player 11 can be downloaded for free from the Microsoft web site.

##### ■ Windows Media Player 12 Setup

#### 1 Start Windows Media Player 12.

#### 2 On the “Stream” menu, select “Turn on media streaming”.

A dialog box appears.

#### 3 Move your cursor and click on “Turn on media streaming”.

A list of media server appears. Wording may vary slightly depending on the network location.

#### 4 Select the product in the list, and then click “Allowed”.

#### 5 Click “OK” to close the dialog box.

This completes the Windows Media Player 12 configuration.

You can now play the music files in your Windows Media Player 12 library.

### Playing Music Files

#### 1 Start your computer or media server.

#### 2 Press [NET] button.

“NET” appears in the display. If it flashes, confirm the network connection.

#### 3 Use [^]/[v] to select “DLNA”, and press [ENTER].

To go back to the previous display, press [RETURN].

#### 4 Use [^]/[v] to select a server, and then press [ENTER].

The menu is displayed according to the server functions.

##### Notes:

- The search function does not work with media servers which do not support this function.
- Photos and movies stored on a media server cannot be accessed from the tuner.

- Depending on the sharing settings in the media server, the tuner may not be able to access the content. See the instruction manual of the media server.

### Tip:

You can also use the tuner's [MENU], [▶/||], [◀◀], or [▶▶] buttons as follows.

- [MENU]: Hold down to move to the top menu.
- [▶/||]: Start playback / Pause playback
- [◀◀]: Select the beginning of the current song (hold down to fast reverse)
- [▶▶]: Select the next song (hold down to fast forward)

(These operations are available depending on the service and the items displayed.)

---

### 5 Use [^]/[v] to select an item, and then press [ENTER] or [▶/||] to start playback.

#### Notes:

- Depending on the media server, [◀◀]/[▶▶]/[▶/||] may not work.
- If the message “No Item.” appears, this means that no information can be retrieved from the server. In this case, check your server, network, and tuner connections.

---

## Remote Playback

You need to connect the tuner to your home network, see “Network/USB Features” (→ page 29)

Remote Playback means you can play the music files stored on a media server or personal computer with the tuner by operating the controller device in the home network.

### Windows Media Player 12 Setup

This section explains how to configure Windows Media Player 12 so that the tuner can play the music files stored on your personal computer.

---

#### 1 Start Windows Media Player 12.

---

#### 2 On the “Stream” menu, select “Turn on media streaming”.

A dialog box appears.

---

#### 3 Move your cursor and click on “Turn on media streaming”.

A list of media server appears. Wording may vary slightly depending on the network location.

---

#### 4 Select the product in the list, and then click “Allowed”.

---

#### 5 Click “OK” to close the dialog box.

This completes the Windows Media Player 12 configuration.

You can now play the music files in your Windows Media Player 12 library.

---

## Using Remote Playback

---

#### 1 Start Windows Media Player 12.

To enable remote playback, you must first configure Windows Media Player 12.

---

#### 2 Press [NET] button.

The “NET” appears in the display. If it flashes, verify the network connection.

---

#### 3 Use [^]/[v] to select “DLNA”, and press [ENTER].

A list of media server appears.

#### Note:

Remote playback cannot be used while the music files of another media server are being played. You must stop their playback first.

---

#### 4 On Windows Media Player 12, right-click on music file.

Right-click menu appears. For selecting another media server, select media server from “Other Libraries” menu on Windows Media Player 12.

---

#### 5 Select the tuner from right-click menu.

“Play to” window appears and playback on the product starts. Operations during remote playback can be made from “Play to” window of Windows 7 on your personal computer. During remote playback, operations (such as Playback, Pause, Fast Forward, Fast Rewind, Previous, Next, Repeat, Random) cannot be made.

# Network/USB Features

## Connecting to the Network

The following diagram shows how you can connect the tuner to your home network. In this example, it's connected to a LAN port on a router, which has a 4-port 100 Base-TX switch built-in.

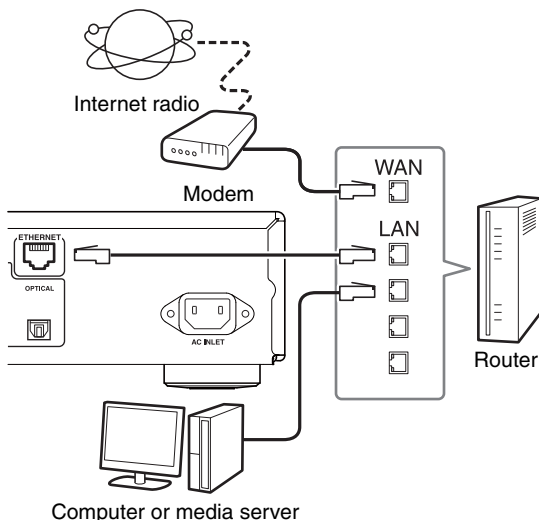

## Network Requirements

### ■ Ethernet Network

For the best results, a 100 Base-TX switched Ethernet network is recommended. Although it's possible to play music on a computer that's connected to the network wirelessly, playback may be unreliable, so it is recommended to use wired connections.

### ■ Ethernet Router

A router manages the network, data-routing and supplying of IP addresses. Your router must support the following:

- NAT (Network Address Translation). NAT allows several networked computers to access the Internet simultaneously via a single Internet connection. The tuner needs Internet access for Internet radio.
- DHCP (Dynamic Host Configuration Protocol). DHCP supplies IP addresses to the network devices, allowing them to configure themselves automatically.
- A router with a built-in 100 Base-TX switch is recommended.

Some routers have a built-in modem, and some ISPs require you to use specific routers. Please consult your ISP or computer dealer if you're unsure.

### ■ CAT5 Ethernet cable

Use a shielded CAT5 Ethernet cable (straight-type) to connect the tuner to your home network.

### ■ Internet Access (for Internet radio)

To receive Internet radio, your Ethernet network must have Internet access. A narrowband Internet connection (e.g., 56 K modem, ISDN) will not provide satisfactory results, so a broadband connection is strongly recommended (e.g., cable modem, xDSL modem, etc). Please consult your ISP or computer dealer if you're unsure.

### Notes:

- To receive Internet radio with the tuner, your broadband Internet connection must be working and able to access the Web. Consult your ISP if you have any problems with your Internet connection.
- The tuner uses DHCP to configure its network settings automatically. If you want to configure these settings manually, see "Network Setup" (→ page 32).
- The tuner does not support PPPoE settings, so if you have a PPPoE-type Internet connection, you must use a PPPoE-compatible router.
- Depending on your ISP, you may need to specify a proxy server to use Internet radio. If your computer is configured to use a proxy server, use the same settings for the tuner (→ page 32).

## Server Requirements

### ■ Server playback

The tuner can play digital music files stored on a computer or media server and supports the following technologies:

- Windows Media Player 11
- Windows Media Player 12
- Windows Media Connect 2.0
- DLNA-certified media server

If the operating system of your computer is Windows Vista, Windows Media Player 11 is already installed. Windows Media Player 11 for Windows XP can be downloaded for free from the Microsoft web site.

- The computer or media server must be on the same network as the tuner.
- Each folder may contain up to 20000 music files, and folders may be nested up to 16 levels deep.

### Note:

Depending on the media server, the tuner may not recognize it, or may not be able to play its music files.

### ■ Remote playback

- Windows Media Player 12
- DLNA-certified (within DLNA Interoperability Guidelines version 1.5) media server or controller device
- Setting varies depending on the device. Refer to your device's instruction manual for details. If the operating system of your personal computer is Windows 7, Windows Media Player 12 is already installed. For more information, see the Microsoft web site.

### Minimum system requirements for Windows Media Player 11 on Windows XP

#### Operating system

Windows XP Home Edition (SP2), Windows XP Professional (SP2), Windows XP Tablet PC Edition (SP2), Update Rollup 2 for Windows XP Media Center Edition 2005 (KB900325), October 2006 Update Rollup for Windows XP Media Center Edition (KB925766)

**Processor:** 233 MHz Intel Pentium II, Advanced Micro Devices (AMD), etc.

**Memory:** 64 MB

**Hard disk:** 200 MB of free space

**Drive:** CD or DVD drive

**Modem:** 28.8 kbps

**Sound card:** 16-bit sound card

**Monitor:** Super VGA (800 x 600)

**Video card:** 64 MB VRAM, DirectX 9.0 b

**Software:** Microsoft ActiveSync (only when using a Windows Mobile-based Pocket PC or smartphone)

**Web browser:** Microsoft Internet Explorer 6 or Netscape 7.1

### USB Device Requirements

- USB mass storage device class (but not always guaranteed).
- FAT16 or FAT32 file system format.
- If the storage device has been partitioned, each section will be treated as an independent device.
- Each folder may contain up to 20,000 music files and folders, and folders may be nested up to 16 levels deep.
- USB hubs and USB devices with hub functions are not supported.

### Supported Audio File Formats

For server playback and playback from a USB device, the tuner supports the following music file formats. Not all servers support all formats.

Variable bit-rate (VBR) files are supported. However, playing times may not display correctly.

#### Notes:

- With remote playback, the tuner does not support the following music file formats: FLAC and Ogg Vorbis.
- In the case of server playback, the above-mentioned file formats may not be played depending on the server type.

#### ■ MP3 (.mp3 or .MP3)

- MP3 files must be MPEG-1/MPEG-2 Audio Layer 3 format with a sampling rate of 8 kHz, 11.025 kHz, 12 kHz, 16 kHz, 22.05 kHz, 24 kHz, 32 kHz, 44.1 kHz, 48 kHz and bitrates of between 8 kbps and 320 kbps. Incompatible files cannot be played.

#### ■ WMA (.wma or .WMA)

WMA stands for Windows Media Audio and is an audio compression technology developed by Microsoft Corporation. Audio can be encoded in WMA format by using Windows Media® Player.

- WMA files must have the copyright option turned off.
- Sampling rates of 8 kHz, 11.025 kHz, 12 kHz, 16 kHz, 22.05 kHz, 24 kHz, 32 kHz, 44.1 kHz, 48 kHz, bitrates of between 5 kbps and 320 kbps, and WMA DRM are supported.
- WMA Pro/Voice formats are not supported.

#### Note:

In the case of playback of WMA DRM contents, the sound is not output from AES/EBU terminal because of the copyright protection.

#### ■ WMA Lossless (.wma or .WMA)

- Sampling rates of 44.1 kHz, 48 kHz, 88.2 kHz, 96 kHz are supported.
- Quantization bit: 16 bit, 24 bit

#### ■ WAV (.wav or .WAV)

WAV files contain uncompressed PCM digital audio.

- Sampling rates of 8 kHz, 11.025 kHz, 12 kHz, 16 kHz, 22.05 kHz, 24 kHz, 32 kHz, 44.1 kHz, 48 kHz, 64 kHz, 88.2 kHz, and 96 kHz are supported.
- Quantization bit: 8 bit, 16 bit, 24 bit

#### ■ AAC

(.aac/.m4a/.mp4/.3gp/.3g2/.AAC/.M4A/.MP4/.3GP or .3G2) AAC stands for MPEG-2/MPEG-4 Audio.

- Sampling rates of 8 kHz, 11.025 kHz, 12 kHz, 16 kHz, 22.05 kHz, 24 kHz, 32 kHz, 44.1 kHz, 48 kHz, 64 kHz, 88.2 kHz, 96 kHz and bitrates of between 8 kbps and 320 kbps are supported.

#### ■ FLAC (.flac or .FLAC)

FLAC is a file format for lossless audio data compression.

- Sampling rates of 8 kHz, 11.025 kHz, 12 kHz, 16 kHz, 22.05 kHz, 24 kHz, 32 kHz, 44.1 kHz, 48 kHz, 64 kHz, 88.2 kHz, and 96 kHz are supported.
- Quantization bit: 8 bit, 16 bit, 24 bit

#### ■ Ogg Vorbis (.ogg or .OGG)

- Sampling rates of 8 kHz, 11.025 kHz, 12 kHz, 16 kHz, 22.05 kHz, 24 kHz, 32 kHz, 44.1 kHz, 48 kHz and bitrates of between 48 kbps and 500 kbps are supported. Incompatible files cannot be played.

#### ■ LPCM (Linear PCM)

- Sampling rates of 8 kHz, 11.025 kHz, 12 kHz, 16 kHz, 22.05 kHz, 24 kHz, 32 kHz, 44.1 kHz, 48 kHz, 64 kHz, 88.2 kHz, and 96 kHz are supported.
- Quantization bit: 8 bit, 16 bit, 24 bit
- \* Only for playback via network.

### About DLNA

The Digital Living Network Alliance is an international, cross-industry collaboration. Members of DLNA develop a concept of wired and wireless interoperable networks where digital content such as photos, music, and videos can be shared through consumer electronics, personal computers, and mobile devices in and beyond the home. The tuner complies with the DLNA Interoperability Guidelines version 1.5.

# Advanced Setup

## Setting the Display Brightness

You can adjust the brightness of the display.

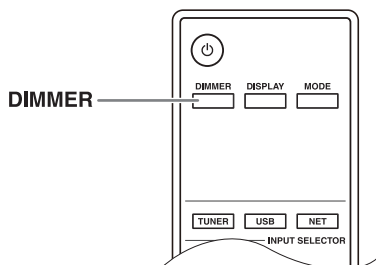

- 1 Press the remote controller's [DIMMER] button repeatedly to select: dim, dimmer, or normal brightness.

## Changing the Advanced Setup Settings

Here's how to change the Advanced Setup settings.

### Example: Music Optimizer setting procedure

#### Music Optimizer

- Turn this setting on to enhance the sound quality of compressed music files.  
Use it with music files that use “lossy” compression, such as MP3.
- The Music Optimizer function is invalid in the source where the sampling rate is 96 kHz or more.

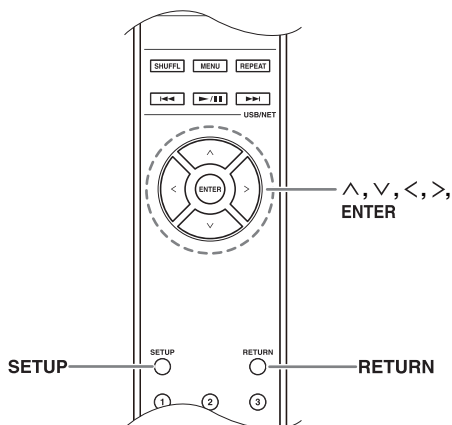
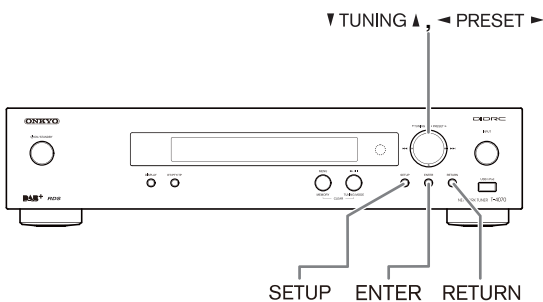

- 1 Turn on the power.

- 2 Press the [SETUP] button on the remote controller.

The setup menu appears in the display.

- 3 Use the arrow [^]/[v] buttons to select “1. Hardware Setup,” and then press [ENTER].

The Hardware setup menu appears in the display.

```
1. Hardware
   Setup
```

- 4 Use the arrow [^]/[v] buttons to select “Music Optimizer: Off”.

```
MusicOptimizer
# off
```

- 5 Change the Music Optimizer to “On” using the arrow [<]/[>] buttons.

```
MusicOptimizer
# on
```

- 6 Press the [SETUP] button on the remote controller to complete the setting.

#### Notes:

- This procedure can also be performed on the tuner by using [SETUP], TUNING [^]/[v], PRESET [◀]/[▶], and [ENTER].
- Press [RETURN] to return to the previous menu.

### Advanced Setup Menu

#### 1. Hardware Setup

---

##### Auto Standby

When “Auto Standby” is set to “On”, the tuner will automatically enter Standby mode if there is no operation for 30 minutes with no audio signal input. “Auto Standby” will appear on the display 30 seconds before the Auto Standby comes on.

Default setting: On

##### Notes:

- With some sources, the Auto Standby function may activate itself during playback.

##### AM Frequency Setup

For AM tuning to work properly, you must specify the AM frequency step (9 kHz/10 kHz) used in your area. Note that when this setting is changed, all radio presets will be deleted.

Default setting: 9 kHz

##### Music Optimizer

See page 31.

#### 2. Network Setup

---

This section explains how to configure the tuner’s network settings manually.

If your router’s DHCP server is enabled, you don’t need to change any of these settings, as the tuner is set to use DHCP to configure itself automatically by default (i.e., DHCP is set to “Enable”). If, however, your router’s DHCP server is disabled (you’re for example using static IP), you’ll need to configure these settings yourself, in which case, a knowledge of Ethernet networking is essential.

##### Note:

The setup menu display will become available several tens of seconds after the tuner has started up.

##### What’s DHCP?

DHCP (Dynamic Host Configuration Protocol) is used by routers, computers, the tuner, and other devices to automatically configure themselves on a network.

##### What’s DNS?

The DNS (Domain Name System) translates domain names into IP addresses. For example, when you enter a domain name such as `www.onkyousa.com` in your Web browser, before accessing the site, your browser uses DNS to translate this into an IP address, in this case `63.148.251.142`.

##### MAC Address

This is the tuner’s MAC (Media Access Control) address. This address cannot be changed.

##### DHCP

This setting determines whether or not the tuner uses DHCP to automatically configure its IP Address, Subnet Mask, Gateway, and DNS Server settings.

Enable (Default setting)

Disable

##### Note:

If you select “Disable”, you must configure the “IP Address”, “IP Address 2”, “Subnet Mask”, “Gateway”, and “DNS Server” settings yourself.

##### IP Address

This value is address required to use internet radio and DLNA.

Enter a static IP address provided by your ISP.

Class A: “10.0.0.0” to “10.255.255.255”

Class B: “172.16.0.0” to “172.31.255.255”

Class C: “192.168.0.0” to “192.168.255.255”

Most routers use Class C IP addresses.

##### IP Address 2

This value is an address required to use AirPlay.

Enter a static IP address provided by your ISP.

##### Subnet Mask

Enter the subnet mask address provided by your ISP (typically `255.255.255.0`).

##### Gateway

Enter the gateway address provided by your ISP.

##### DNS Server

Enter a DNS server address provided by your ISP.

##### Proxy URL

To use a Web proxy, enter its URL here.

##### Proxy Port

If you’re using a Web proxy, enter a proxy port number here.

##### Network Control

This setting enables or disables control over the network.

Enable

Disable (Default setting)

##### Note:

When set to “Enable”, the NET indicator is dimly-lit and the power consumption slightly increases in standby mode.

##### E-Control Port

This is the network port used for control over the network.

“49152” to “65535”



- If you've made a change to any item, the display will indicate "Save [Enter]: Select" when you exit Network Setup. If you want to apply the changes you made, press [ENTER].
- If you want to re-do the setup, use [V] button to select "Cancel [Enter]: Select" and then press the [ENTER] button.  
You can also perform the same operation by pressing the [RETURN] button.

**Note:**

When the "Network Control" setting is set to "Disable", this setting cannot be selected.

### 3. Firmware Update

---

See "Firmware Update" for the update procedure.

**Notes:**

- The setup menu display will become available several tens of seconds after the tuner has started up.
- Perform the firmware update only when such an announcement is posted on the Onkyo web site. Visit the Onkyo web site for the latest information.
- It takes about 5 to 30 minutes to complete the firmware update.  
(The unit displays the approximate time duration required for the update.)

**Version**

Displays the current version of the firmware.

**Tuner**

**via NET:**

Performs the firmware update via Internet. Check the network connection before updating.

**via USB:**

Performs the firmware update from a USB device.

These settings allow you to update the tuner's firmware. Do not shutdown the power of the tuner while updating.

# Firmware Update

---

To update the firmware of the tuner, you can choose from the following two methods: update via network, or update via USB storage. Choose the one that best suits your environment. Before proceeding with the update, please read the corresponding explanations carefully.

## ■ Update via network

You need a wired Internet connection to update the firmware.

## ■ Update via USB storage (→ page 35)

Please prepare a USB storage device such as a USB flash memory stick. You need at least 32 MB of available space to update the firmware.

### Notes:

- Check the network connection before updating.
- Do not touch the any cable or device connected to the tuner during the updating process.
- Do not attempt to access the tuner from your PC while it is being updated.
- Do not shutdown the power of the tuner while it is being updated.
- The storage media in the USB card reader may not work.
- If the USB device is partitioned, each section will be treated as an independent device.
- If the USB device contains a lot of data, the tuner may take a while to read it.
- Operation is not guaranteed for all USB devices, which includes the ability to power them.
- Onkyo takes no responsibility whatsoever for the loss or damage of data resulting from the use of a USB device with the tuner. Onkyo recommends that you back up your important music files beforehand.
- If you connect a USB hard disk drive to the USB port, Onkyo recommends that you use its AC adapter to power it.
- USB hubs and USB devices with hub functions are not supported. Do not connect your USB device via a USB hub.
- USB devices with security functions are not supported.

### Limitation of liability

The program and accompanying online documentation are furnished to you for use at your own risk. Onkyo will not be liable and you will have no remedy for damages for any claim of any kind whatsoever concerning your use of the program or the accompanying online documentation, regardless of legal theory, and whether arising in tort or contract. In no event will Onkyo be liable to you or any third party for any special, indirect, incidental, or consequential damages of any kind, including, but not limited to, compensation, reimbursement or damages on account of the loss of present or prospective profits, loss of data, or for any other reason whatsoever.

See the Onkyo web site for latest information.

## Updating the Firmware via Network

The tuner allows you to update the firmware using the network connection on the rear panel.

### Notes:

- Make sure your tuner is turned on and an Ethernet cable is connected to the rear panel of the tuner.
- Never unplug or turn off the tuner while it is being updated.
- Never plug or unplug an Ethernet cable during the update process.
- Do not attempt to access the tuner from your PC while it is being updated.
- Never unplug the power cord during the update process.
- It takes about 5 to 30 minutes to complete the firmware update. (The unit displays the approximate time duration required for the update.)
- The tuner will retain all your settings after the update is finished.

### Before you start

---

- Turn off the controller device connected via Ethernet cable.
- Stop playback of contents from Internet Radio, iPod/iPhone, USB or servers, etc.

### Update procedure

---

#### **1 Press the [SETUP] button on the remote controller.**

The Setup menu will be displayed on the tuner's display.

#### **2 Use [^] or [v] button to select "3. Firmware Update" and press [ENTER].**

The current firmware version will be displayed.

#### **3 Use [^] or [v] button to select "Via NET" and press [ENTER].**

#### **4 "Update" is displayed. Press [ENTER].**

The update process will begin. During the update process, you can still view the update progress on the tuner's display.

#### **5 The message "Completed!" appears on the tuner's display, indicating that the update has been completed.**

#### **6 Turn off the tuner using [⏻ ON/STANDBY] on the front panel.**

Do not use [⏻] on the remote controller. Once turned off, the tuner will automatically turn on again. Congratulations! You now have the latest firmware installed on your Onkyo tuner.

---

## Troubleshooting

### Case 1:

If “**No Update**” is displayed on the tuner’s display, it means that the firmware has already been updated. You do not need to do anything further.

### Case 2:

If an error occurs, “**Error!! \*-\*\* No media**” is displayed on the tuner’s display. (Alpha-numeric characters on the front display are denoted by asterisks.) Refer to the following table and take appropriate action.

#### ■ Errors during an update via Network

Error Code	Description
*-10, *-20	The Ethernet cable was not detected. Reconnect the cable properly.
*-11, *-13, *-21, *-28	<p>Internet connection error. Check the following items:</p> <ul style="list-style-type: none"> <li>• Make sure the IP address, subnet mask, gateway address, and DNS server are configured properly.</li> <li>• Make sure the router is turned on.</li> <li>• Make sure the tuner and the router are connected with an Ethernet cable.</li> <li>• Make sure your router is configured properly. See the instruction manual of the router.</li> <li>• If your network allows only one client connection and there is any other device already connected, the tuner will not be able to access the network. Consult your Internet Service Provider (ISP).</li> <li>• If your modem does not function as a router, you will need a router. Depending on your network, you may need to configure the proxy server if necessary. See the document provided by your ISP. If you are still unable to access the Internet, the DNS or proxy server may be temporarily down. Contact your ISP.</li> </ul>

### Case 3:

If an error occurs during the update process, disconnect then reconnect the AC power cord and try again.

### Case 4:

If an error occurs due to a wrong selection of input sources, turn off and on the tuner. Then retry the update.

### Case 5:

If you do not have an Internet connection to the network, please contact Onkyo Support (→ page 36).

## Updating the Firmware via USB

The tuner allows you to update the firmware using a USB device.

### Notes:

- Never unplug or turn off the tuner during the update process.
- Never plug or unplug a USB device during the update process.
- Never unplug the USB storage device containing the firmware file or the AC power cord during the update process.
- Do not attempt to access the tuner from your PC while it is being updated.
- It takes about 5 to 30 minutes to complete the firmware update. (The unit displays the approximate time duration required for the update.)
- The tuner will retain all your settings after the update is finished.

### Before you start

- Turn off the controller device connected via Ethernet cable.
- Stop playback of contents from Internet Radio, iPod/iPhone, USB or servers, etc.
- If there is any data in the USB device, remove it first.

### Update procedure

- 1 Connect a USB device to your PC. If there is any data in the USB device, remove it first.**
- 2 Download the firmware file from the Onkyo web site. The file name is as follows:**  
 ONKTUN\*\*\*\*\_\*\*\*\*\*.zip  
**Unzip the downloaded file. The following some/any files are created:**  
 ONKTUN\*\*\*\*\_\*\*\*\*\*.of1  
 ONKTUN\*\*\*\*\_\*\*\*\*\*.of2
- 3 Copy the extracted files to the USB device. Be careful not to copy the zip file.**
- 4 Remove the USB device from your PC and connect it to the USB port on the tuner.**
- 5 Make sure the tuner is turned on.**  
 If the tuner is in standby mode, press [⏻ ON/STANDBY] on the tuner to light the front display.

### 6 Select the USB input source.

“Now Initializing” is displayed on the tuner’s display and then the name of the USB device is displayed. It takes 20 to 30 seconds to recognize the USB device.

### 7 Press the [SETUP] button on the remote controller.

Setup menu will be displayed on the tuner’s display.

### 8 Use [^] or [v] button to select “3. Firmware Update” and press [ENTER].

### 9 Use [^] or [v] button to select “Via USB” and press [ENTER].

### 10 “Update” is displayed. Press [ENTER].

The update process will begin.

During the update process, you can still view the update progress on the front display of the tuner.

Do not turn off the tuner and do not remove the USB device during the update process.

### 11 The message “Completed!” appears on the front display of the tuner, indicating that the update has been completed.

Remove the USB device.

### 12 Turn off the tuner using [ON/STANDBY] on the front panel.

Do not use [ON] on the remote controller.

Once turned off, the tuner will automatically turn on again.

Congratulations! You now have the latest firmware installed on your Onkyo tuner.

## Troubleshooting

### Case 1:

If “No Update” is displayed on the front display of the tuner, it means that the firmware has already been updated. You do not need to do anything further.

### Case 2:

If an error occurs, “Error!! \*-\* No media” is displayed on the front display of the tuner. (Alpha-numeric characters on the front display are denoted by asterisks.) Refer to the following table and take appropriate action.

### ■ Errors during an update via USB

Error Code	Description
*-10, *-20	The USB device was not detected. Make sure the USB flash memory or USB cable is properly connected to the USB port. If the USB storage device has its own power supply, use it to power the USB device.
*-14	The firmware file was not found in the root folder of the USB device, or the firmware file is for another model. Retry and download the file on the support page of the web site, following the on-site instructions. If the error persists, please contact Onkyo Support and provide the error code.
Others	Retry the update procedure from the beginning. If the error persists, please contact Onkyo Support and provide the error code.

### Case 3:

If an error occurs during the update, disconnect then reconnect the AC power cord and try again.

### Case 4:

If an error occurs due to a wrong selection of input sources, turn off and on the tuner. Then retry the update.

### ONKYO SOUND & VISION CORPORATION

2-1, Nisshin-cho, Neyagawa-shi, OSAKA 572-8540, JAPAN

<<http://www.onkyo.com/>>

### The Americas

ONKYO U.S.A. CORPORATION

18 Park Way, Upper Saddle River, N.J. 07458, U.S.A.

Tel: 800-229-1687, 201-785-2600

Fax: 201-785-2650

Hours: M-F 9am-8pm/Sat-Sun 10am-4pm ET

<<http://www.us.onkyo.com/>>

### Europe

ONKYO EUROPE ELECTRONICS GmbH

Liegnitzerstrasse 6, 82194 Grobenzell, GERMANY

Tel: +49-8142-4401-0 Fax: +49-8142-4401-555

<<http://www.eu.onkyo.com/>>

### China, Hong Kong

ONKYO CHINA LIMITED

Unit 1033, 10/F, Star House, No.3, Salisbury Road, Tsim Sha Tsui Kowloon, Hong Kong.

Tel: 852-2429-3118 Fax: 852-2428-9039

<<http://www.onkyochina.com/>>

### Asia, Oceania, Middle East, Africa

Please contact an ONKYO distributor referring to Onkyo SUPPORT site.

<[http://www.intl.onkyo.com/support/local\\_support/index.html](http://www.intl.onkyo.com/support/local_support/index.html)>

# Troubleshooting

If you have any trouble using the tuner, look for a solution in this section.

If you can't resolve the issue yourself, try resetting the tuner before contacting your Onkyo dealer.

**To reset the tuner to its factory defaults, turn it on and, while holding down the [TUNING MODE] button, press the [ON/STANDBY] button.**

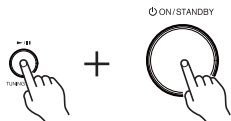

Note that resetting the tuner will delete your radio presets and custom settings.

## Power

### Can't turn on the tuner

- Make sure that the power cord is plugged into the electric outlet properly.
- Unplug the power cord from the electric outlet, wait 5 seconds or more, then plug it in again.

## Audio

### There's no sound or it's very quiet

- Make sure that all audio connecting plugs are pushed in all the way (→ page 12-15).
- Make sure that the inputs and outputs of all components are connected properly.
- Make sure that the correct input source is selected.

### Noise can be heard

- Using cable ties to bundle audio cables with power cords, speaker cables, and so on may degrade the audio performance; do not bundle audio cables together with power cords or speaker cables.
- An audio cable may be picking up interference. Try repositioning your cables.

## Tuner

### Reception is noisy, stereo FM reception suffers from hiss, or the FM STEREO indicator doesn't appear

- Relocate your antenna.
- Move the tuner away from your TV or computer.
- Listen to the station in mono (→ page 16).
- When listening to an AM station, operating the remote controller may cause noise.
- Passing cars and airplanes can cause interference.
- Concrete walls weaken radio signals.
- If nothing improves the reception, install an outdoor antenna.

## Remote Controller

### The remote controller doesn't work

- Make sure that the batteries are installed with the correct polarity (→ page 6).
- Install new batteries. Don't mix different types of batteries or old and new batteries (→ page 6).
- Make sure that the remote controller is not too far away from the receiver, and that there's no obstruction between the remote controller and the receiver's remote control sensor (→ page 6).
- Make sure that the receiver is not subjected to direct sunshine or inverter-type florescent lights. Relocate if necessary.

## Music Server and Internet Radio

### Can't access the server or Internet radio

- Check the network connection between the tuner and your router or switch.
- Make sure that your modem and router are properly connected, and make sure they are both turned on.
- Make sure the server is up and running and compatible with the tuner.
- Check the "Network Setup".

### Playback stops while listening to music files on the server

- Make sure your server is compatible with the tuner.
- If you download or copy large files on your computer, playback may be interrupted. Try closing any unused programs, use a more powerful computer, or use a dedicated server.
- If the server is serving large music files to several networked devices simultaneously, the network may become overloaded and playback may be interrupted. Reduce the number of playback devices on the network, upgrade your network, or use a switch instead of a hub.

### Can't connect to the tuner from a Web browser

- If you're using DHCP, your router may not always allocate the same IP address to the tuner, so if you find that you can't connect to a server or Internet radio station, recheck the tuner's IP address.
- Check the "Network Setup".

## AirPlay

### No sound can be heard during AirPlay playback.

- Click the AirPlay icon to disconnect iTunes or your iPad/iPhone/iPod touch, then reconnect it.
- Turn off the power to the tuner, then turn it on.
- Reset the tuner (→ page 37).
- Restart iTunes or your iPad/iPhone/iPod touch.

### USB Device Playback

#### Can't access the music files on a USB device

- Make sure the USB device is plugged in properly.
- The tuner supports USB devices that support the USB mass storage device class. However, playback may not be possible with some USB devices even if they conform to the USB mass storage device class.
- USB memory devices with security functions cannot be played.

### Others

#### Standby Power Consumption

- In the following cases, the power consumption may reach up to a maximum of 24 W:
  1. “Wake Up On AirPlay” under the “AirPlay” setting is set to “On.”
  2. “Network Control” is set to “Enable” in the “Network Setup” setting.

The tuner contains a microcomputer for signal processing and control functions. In very rare situations, severe interference, noise from an external source, or static electricity may cause it to lockup. In the unlikely event that this happens, unplug the power cord from the wall outlet, wait at least five seconds, and then plug it back in again.

Onkyo is not responsible for damages (such as CD rental fees) due to unsuccessful recordings caused by the unit's malfunction. Before you record important data, make sure that the material will be recorded correctly.

Before disconnecting the power cord from the wall outlet, set the tuner to Standby.

# Specifications

---

## **Tuner Section**

---

### ■ FM

Tuning Frequency Range 87.5 MHz–108.0 MHz RDS

### ■ AM

Tuning Frequency Range 522/530 kHz–1611/1710 kHz

Preset Channel 40

### ■ DAB/DAB+

Tuning Frequency Range Band III:  
174.928 MHz–239.200 MHz  
L-Band:  
1452.960 MHz–1490.624 MHz

## **General**

---

Power Supply AC 230 V, 50 Hz

Power Consumption 28 W

Stand-by Power Consumption 0.3 W

Dimensions (W × H × D) 435 × 101.5 × 307 mm  
(17-1/8" × 4" × 12-1/16")

Weight 5.8 kg (12.8 lbs)

### ■ Audio Outputs

Digital Outputs AES/EBU: 1, OPTICAL: 1,  
COAXIAL: 1

Analog Outputs L/R

### ■ Others

Ethernet 1

USB Front 1

RF 2

Specifications and features are subject to change without notice.

# ONKYO

## ONKYO SOUND & VISION CORPORATION

2-1, Nisshin-cho, Neyagawa-shi, OSAKA 572-8540, JAPAN  
Tel: 072-831-8023 Fax: 072-831-8163  
<http://www.onkyo.com/>

## ONKYO U.S.A. CORPORATION

18 Park Way, Upper Saddle River, N.J. 07458, U.S.A.  
Tel: 800-229-1687, 201-785-2600 Fax: 201-785-2650  
<http://www.us.onkyo.com/>

## ONKYO EUROPE ELECTRONICS GmbH

Liegnitzerstrasse 6, 82194 Groebenzell, GERMANY  
Tel: +49-8142-4401-0 Fax: +49-8142-4401-555  
<http://www.eu.onkyo.com/>

## ONKYO EUROPE ELECTRONICS GmbH (UK BRANCH)

The Coach House 81A High Street, Marlow, Buckinghamshire, SL7 1AB, UK  
Tel: +44-(0)1628-473-350 Fax: +44-(0)1628-401-700

## ONKYO CHINA LIMITED

Unit 1033, 10/F, Star House, No 3, Salisbury Road, Tsim Sha Tsui Kowloon, Hong Kong.  
Tel: 852-2429-3118 Fax: 852-2428-9039  
<http://www.onkyochina.com/>

## ONKYO CHINA PRC

1301, 555 Tower, No.555 West NanJin Road, Jin an, Shanghai,  
China 200041, Tel: 86-21-52131366 Fax: 86-21-52130396  
<http://www.cn.onkyo.com/>

SN 29400930

(C) Copyright 2011 ONKYO SOUND & VISION CORPORATION Japan. All rights reserved.

C1110-1

