

INSTALLATIE VOORSCHRIFT

Dubbele swingdeuren met NANO behandeld glas
20.3845

1000x1000x2000mm
(980-1000) x (980-1000) x 2000mm

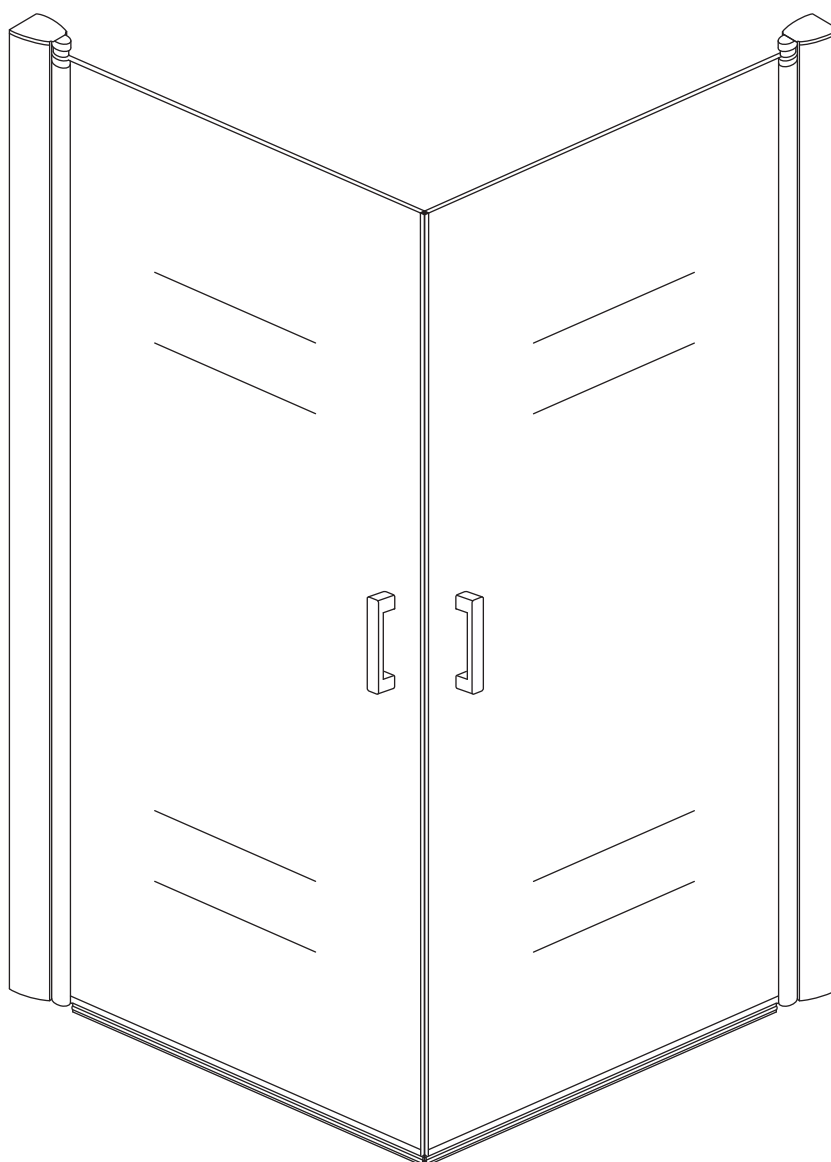



Zonder NANO

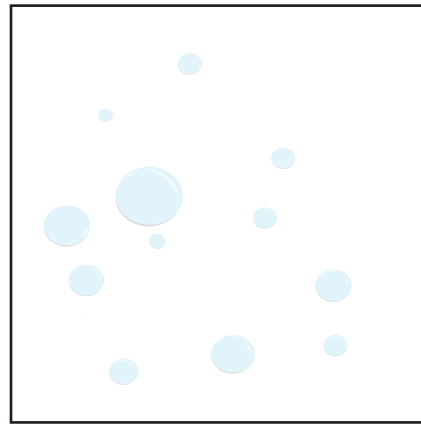

NANO

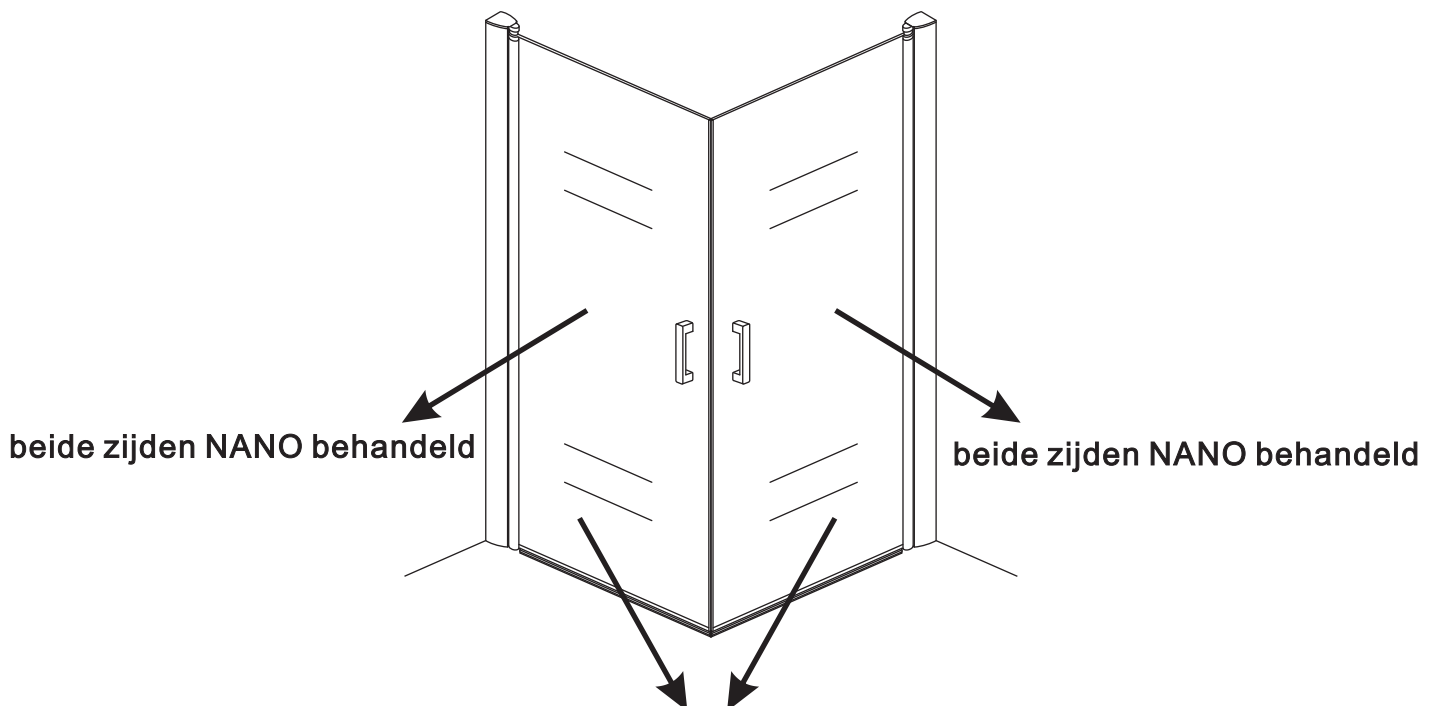

NANO garantie: 2 jaar bij normaal gebruik
LET OP: gebruik geen grove scherpe voorwerpen, zoals schuursponsjes of staalwol om het glas schoon te maken.

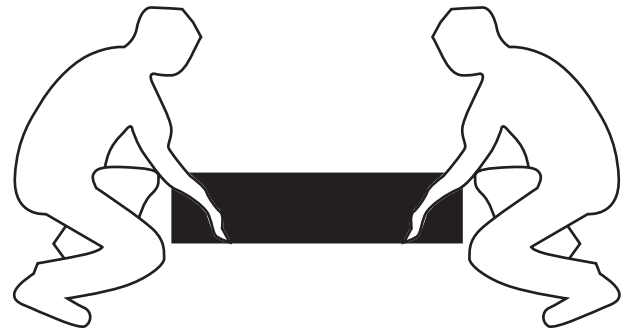
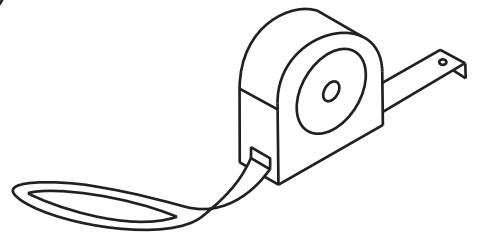
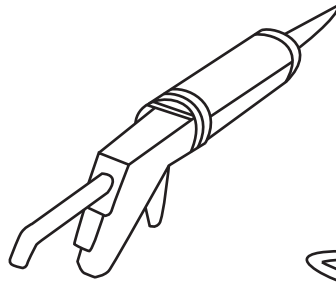
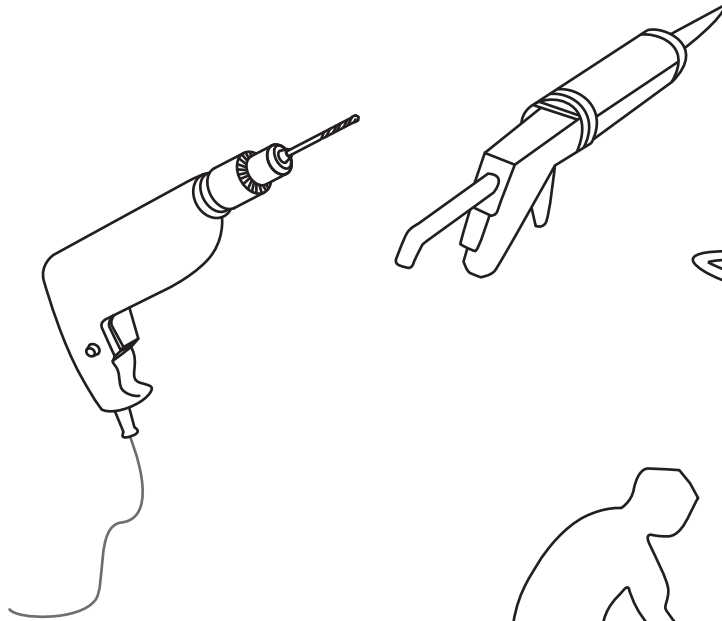
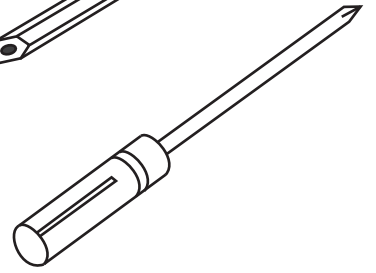
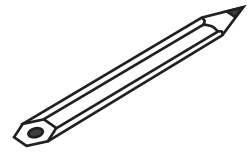
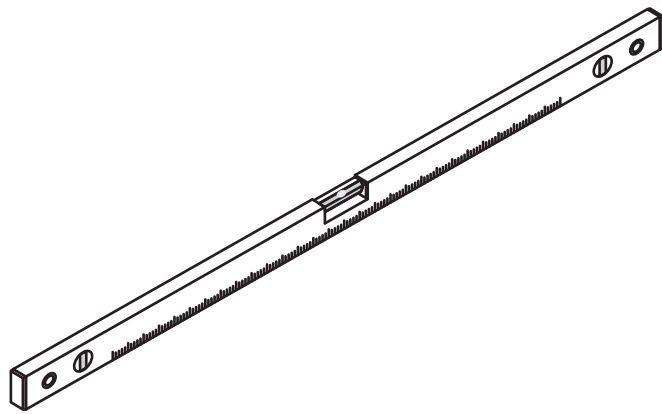

1

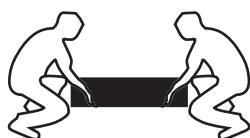

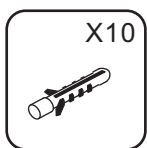
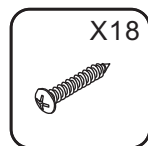
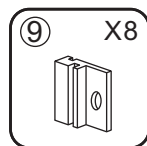
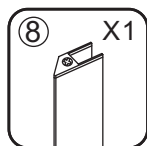
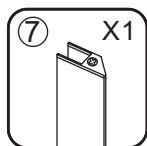
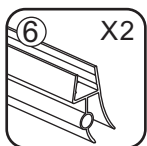
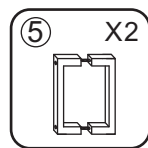
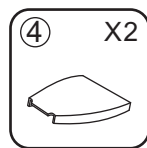
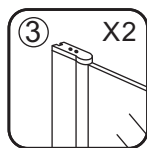
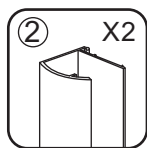
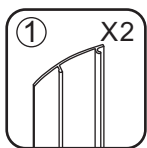
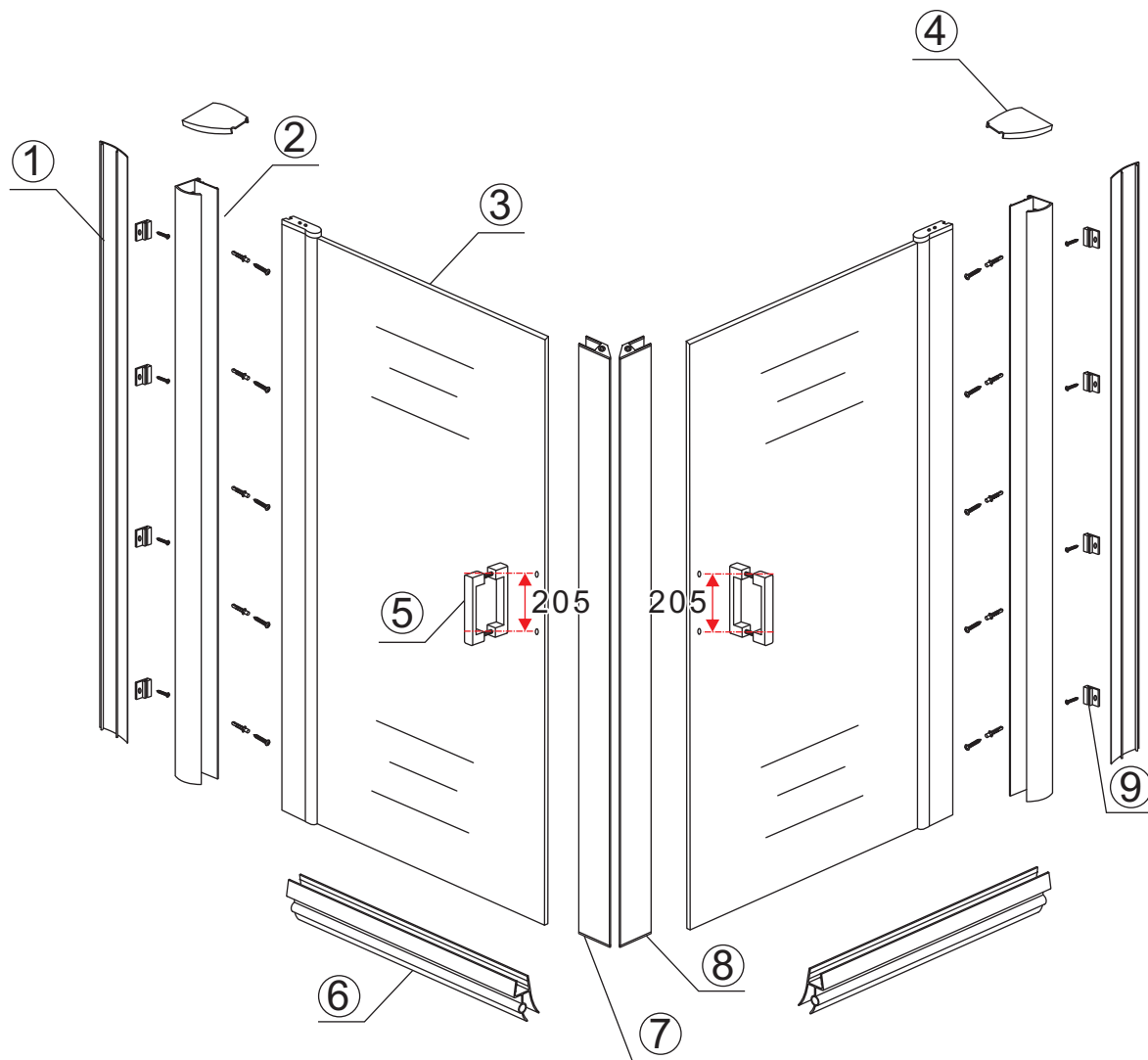

3

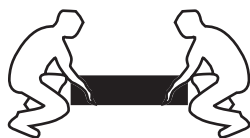
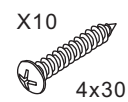
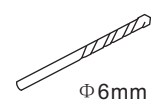
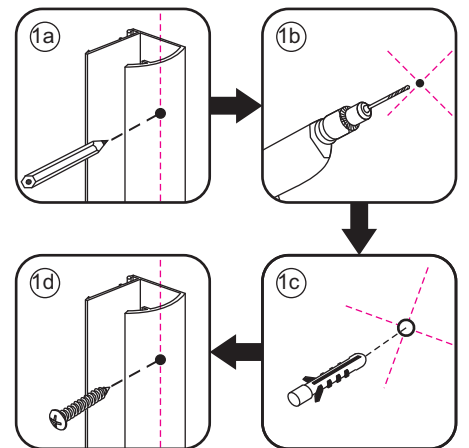
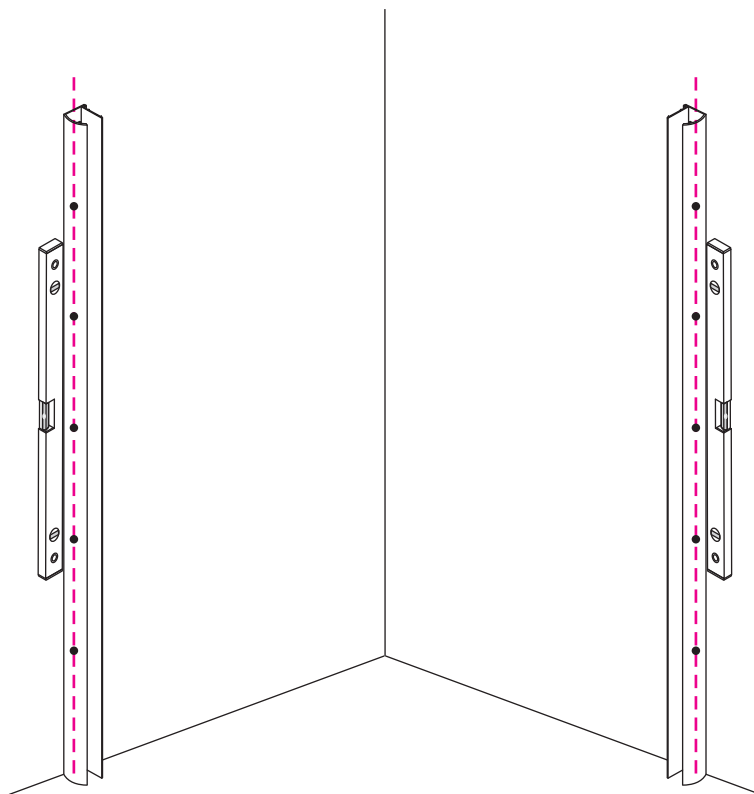
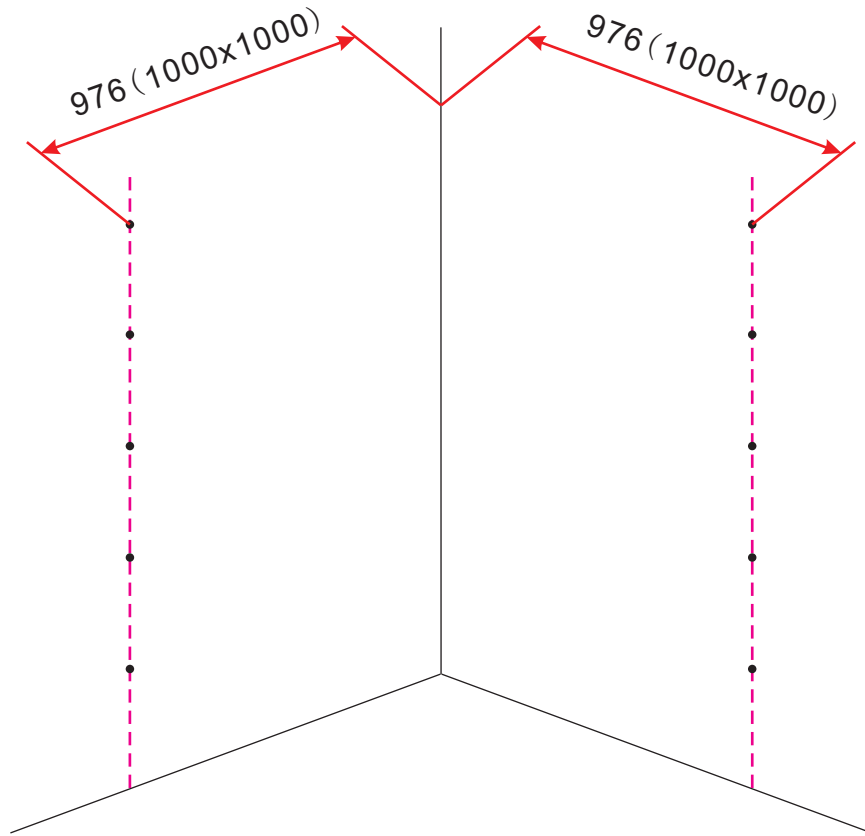

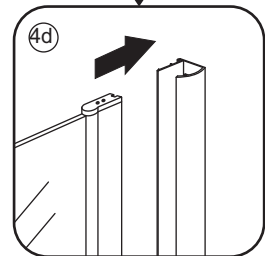
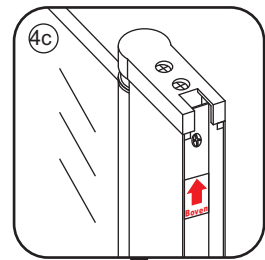
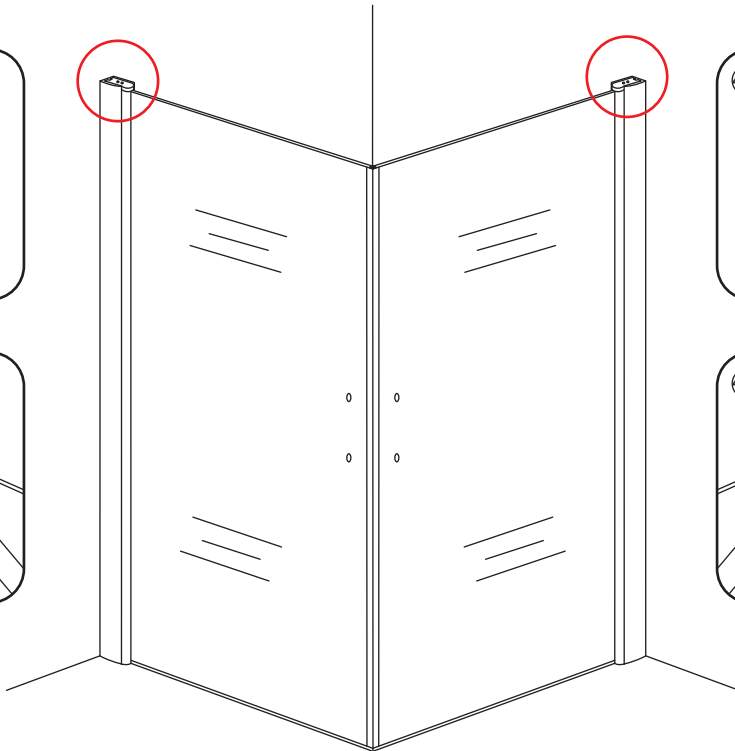
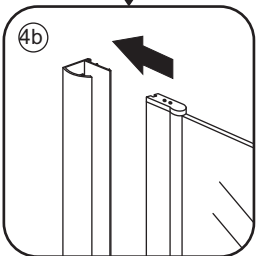
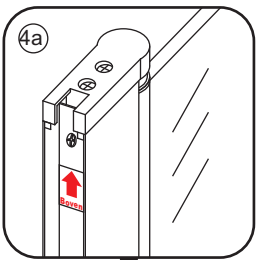
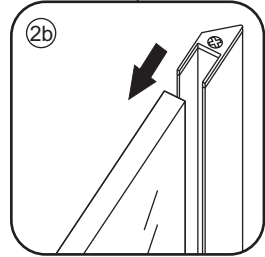
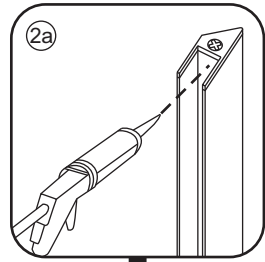
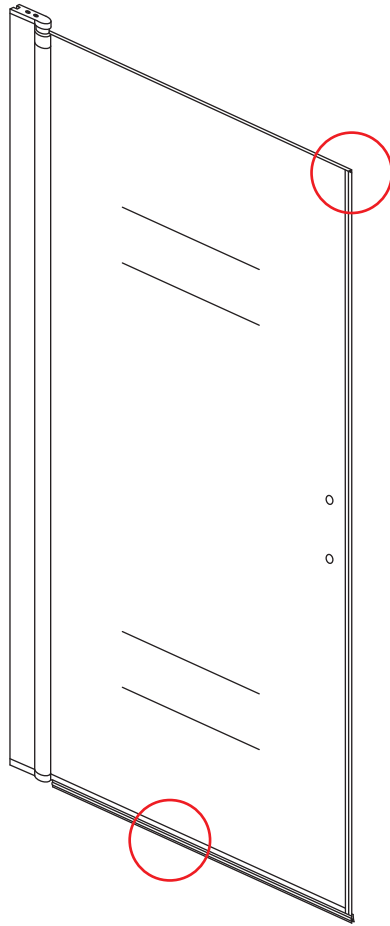
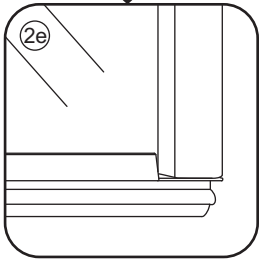
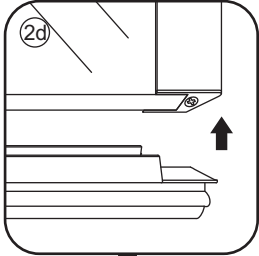
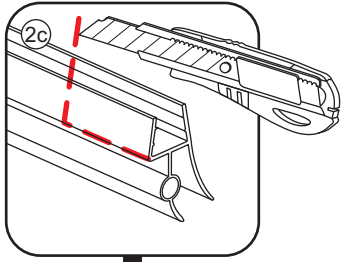

5

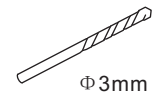
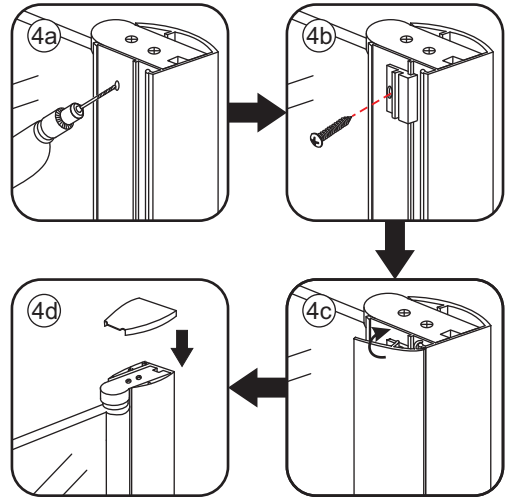
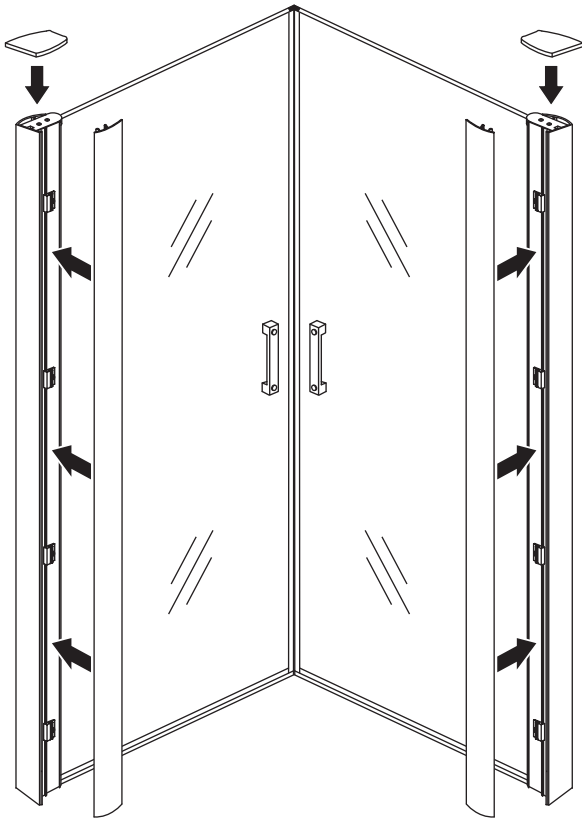

Φ 3mm

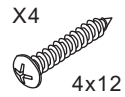

X4

4x12

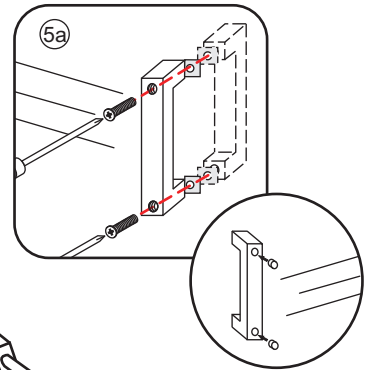
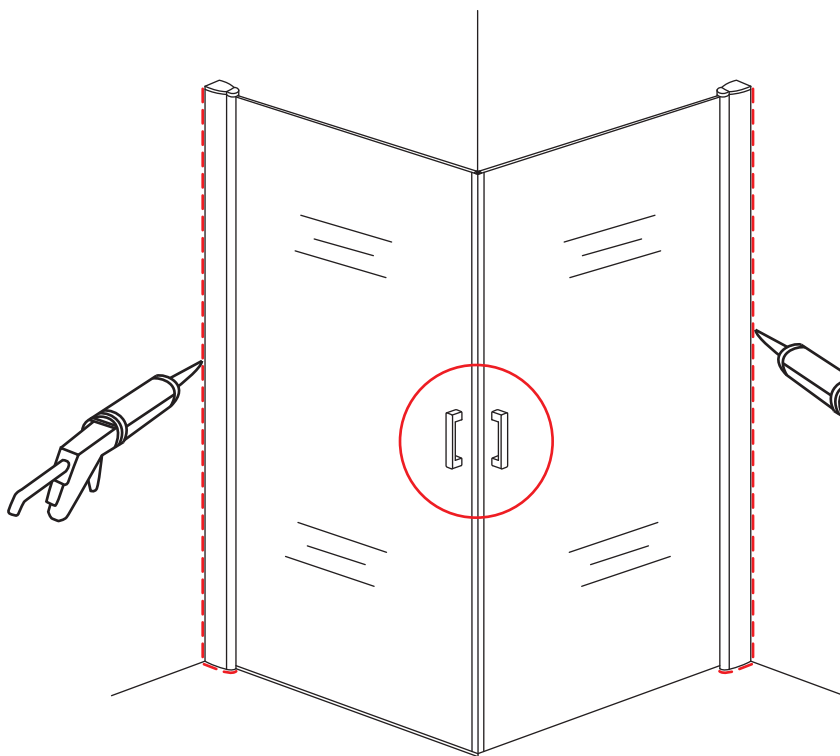

**Voorzie alleen de
buitenzijde van de
cabine van siliconenkit.**

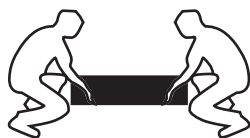

Gehard veiligheidsglas

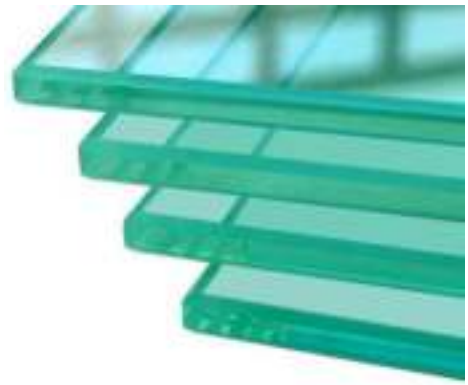

Het glas dat wij gebruiken voor al onze glazen douchewanden, deuren en douchecabines is gehard glas en letselveilig.

Hardglas is thermisch voorgespannen glas en wordt vervaardigd door float- of figuurglas, al dan niet gekleurd of voorzien van een coating, horizontaal in een oven (liggend op rollen) tot ca. 620 graden te verhitten en vervolgens zeer snel en gecontroleerd met lucht af te koelen. Hierdoor ontstaat in het glas een permanente spannings-verdeling, waardoor hardglas circa 5 maal grotere mechanische (stoot-, slag-, en buig-) belasting en temperatuurschok kan weerstaan t.o.v. ongehard glas. Het glas is dus niet harder, maar wel sterker dan ongehard glas. Mocht door één of andere oorzaak toch glasbreuk ontstaan, dan valt de ruit uiteen in ongevaarlijke kleine korrels, waarvan de randen in het algemeen niet scherp zijn.

Gehard glas is te herkennen aan de 'spanningsvlekken' die zichtbaar worden bij een bepaalde lichtval of als men door gepolariseerde (brillen-) glazen naar het glas kijkt. Het vlekkenpatroon geeft echter over de mate van harding weinig informatie.

Het glas dient vóór het hardingsproces te worden gesneden en voorzien van een zekere slijpbewerking en indien gewenst, te worden voorzien van gaten en/of sparingen daar deze bewerkingen na het hardingsproces niet meer mogelijk zijn.

Doordat tijdens het hardingsproces het hete glas in contact komt met rollen, kan er een verandering van het aanzicht van het oppervlak ontstaan in de vorm van rol-afdrukken (in meer of mindere mate), welke zowel 'golf-vormig' als ook 'puntvormig' (inbranding) kunnen zijn en in het algemeen zichtbaar zijn/worden bij spiegeling, donkere achtergrond, strijklicht, aanzicht langs het oppervlak, enz. Dit is inherent aan het productieproces en derhalve niet te voorkomen.

Onder bepaalde omstandigheden kan gehard glas spontaan breken. Dat wordt veroorzaakt door insluiting van nikkelsulfiet. Deze verontreiniging is niet zichtbaar en kan alleen door middel van een Heat Soak test worden aangetoond. Tijdens deze, door onze fabriek uitgevoerde, test wordt een glasplaat opgewarmd tot bijna 300°C. Eventueel aanwezige nikkelsulfide-deeltjes springen tijdens deze test stuk. Glas dat de test goed doorstaat, kan als breukveilig beschouwd worden.