



CREATOR

10254



LEGO.com/creator



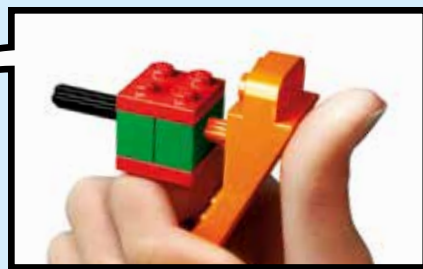
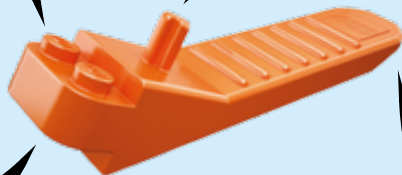
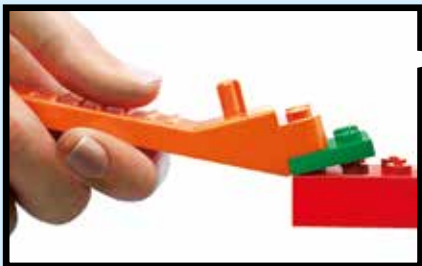

[LEGO.com/brickseparator](https://www.LEGO.com/brickseparator)

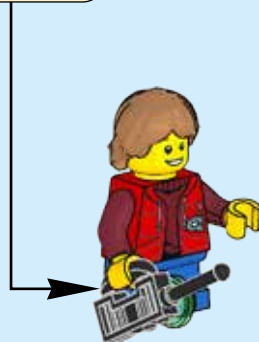

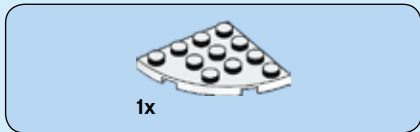

1



2

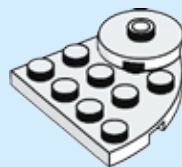



1x



1x

3

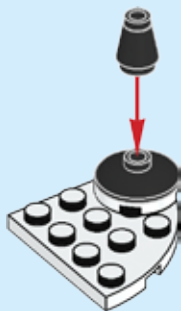

1x



1x

4

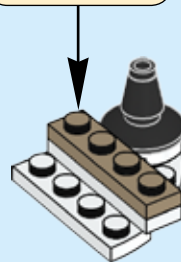
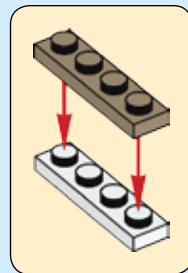



1x

5

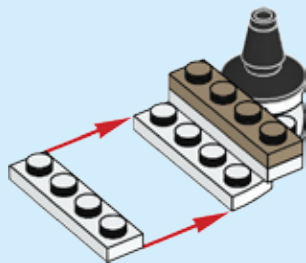

1x



1x

6

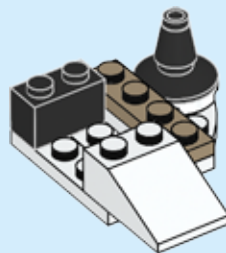

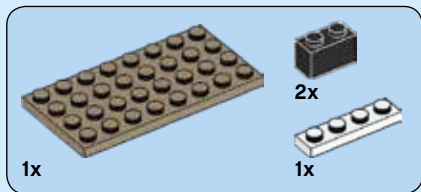

7

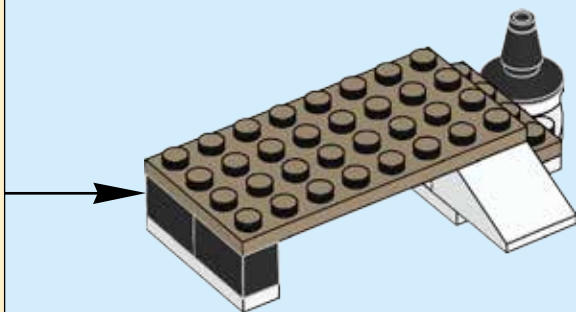
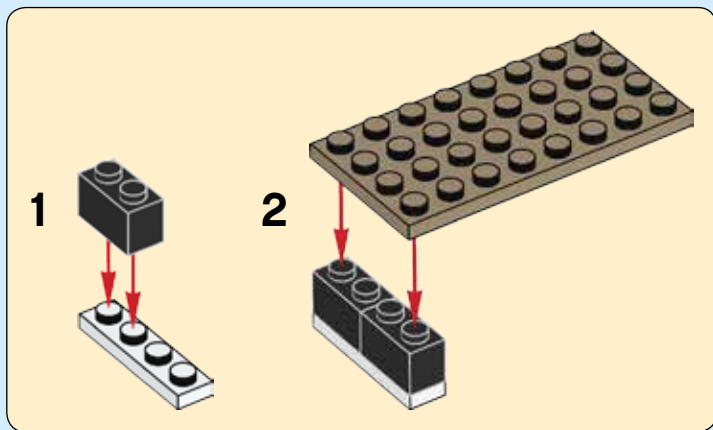

8



4x



2x

8

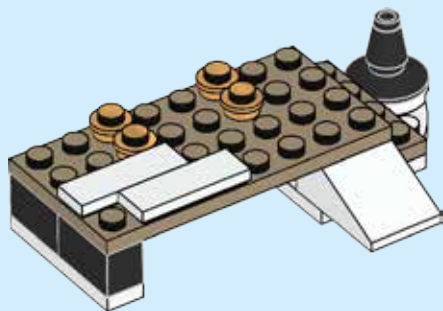

2x

9

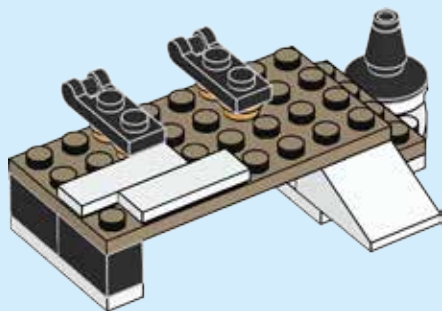

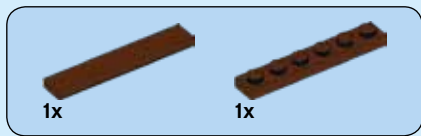

10

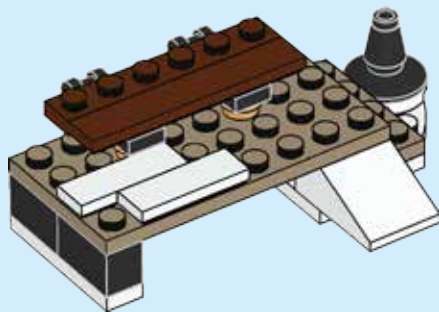

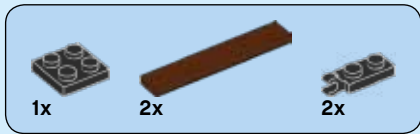

11

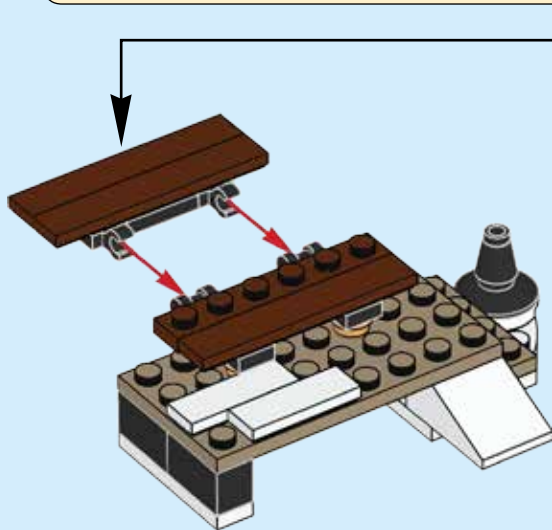
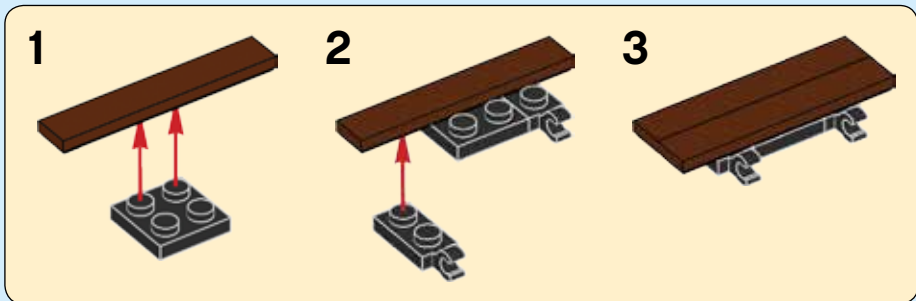

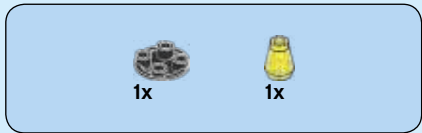

12



13





1x



1x

14



2x

15

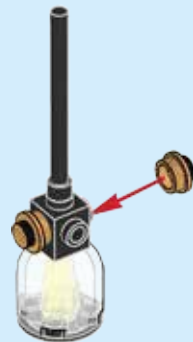

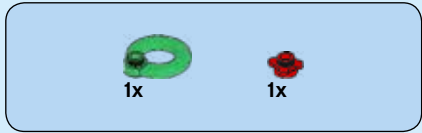

16

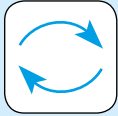

17

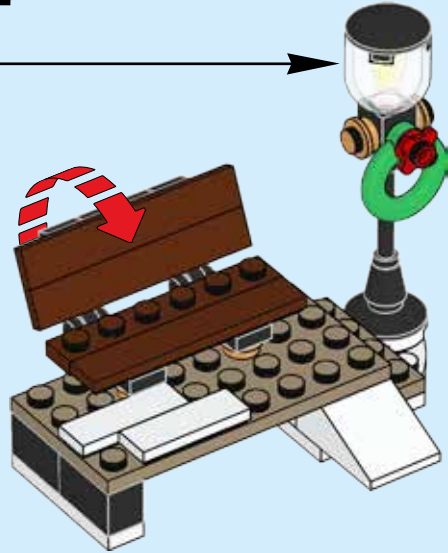



18





19

1

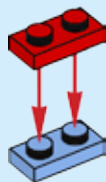

2

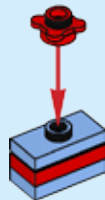

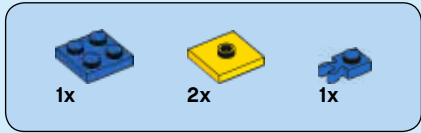

20

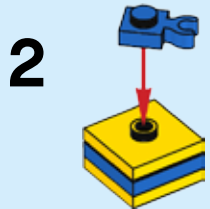
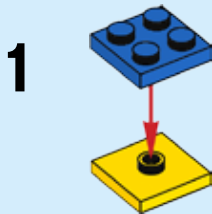

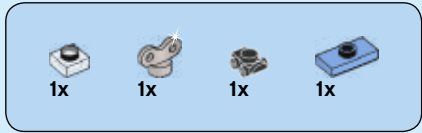

21

1

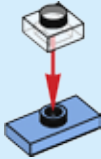

2

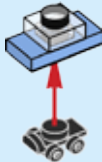

3



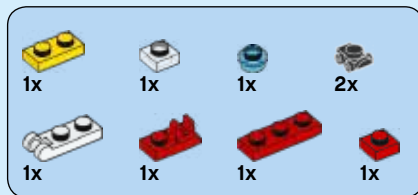

22

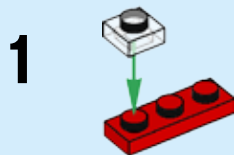

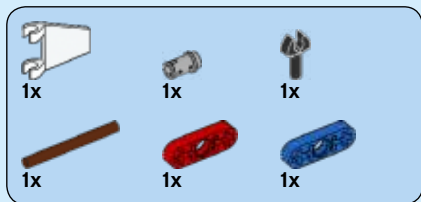

23

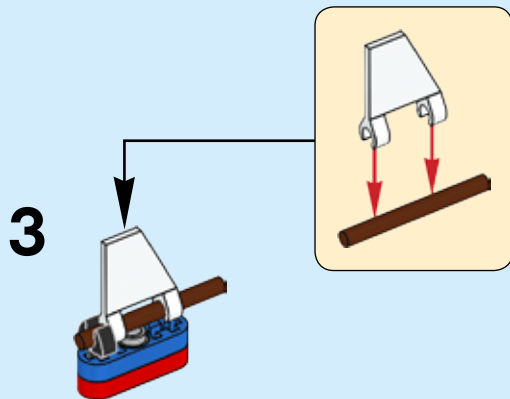
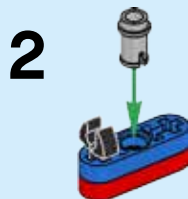
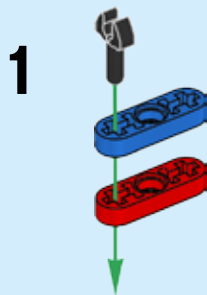



24

1

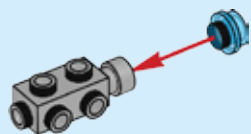

2



3

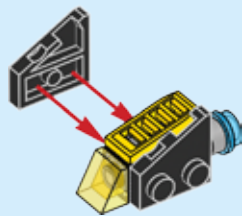

4

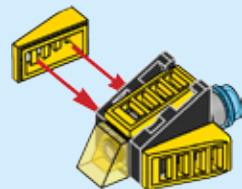

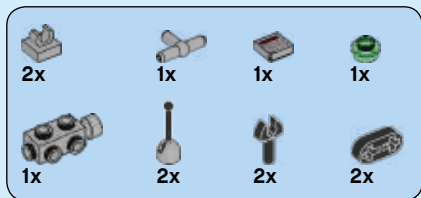

25

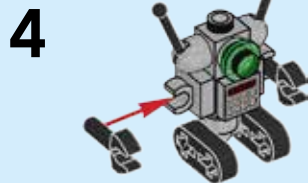
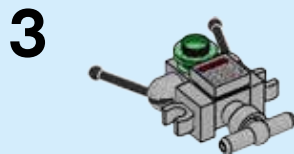
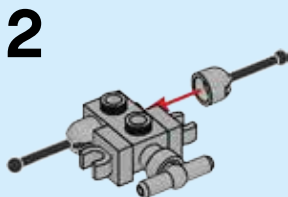
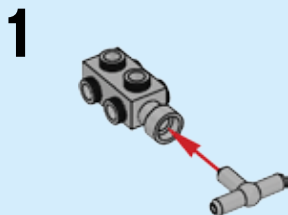

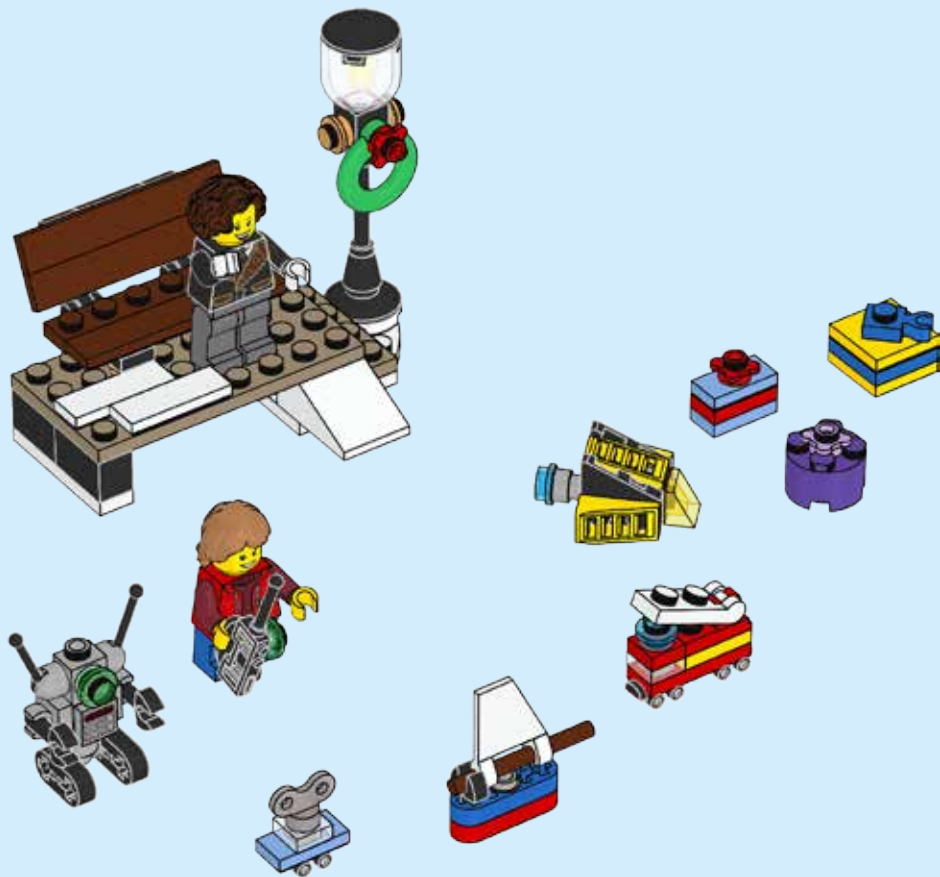



CREATOR

LEGO and the LEGO logo are trademarks of the
LEGO Group. ©2016 The LEGO Group.
6179158



Showcase your awesome builds with the new Creator App!

Apple and the Apple logo are trademarks of Apple Inc., registered in the U.S. and other countries.
App Store is a service mark of Apple Inc.

Google Play is a trademark of Google Inc.

LEGO.com/creator

