

**AXA25**  
INTEGRATED AMPLIFIER

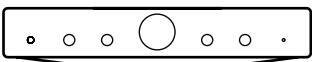

# Contents

<b>IMPORTANT SAFETY INSTRUCTIONS</b>	<b>3</b>
<b>REAR PANEL CONNECTIONS</b>	<b>5</b>
<b>FRONT PANEL CONTROLS</b>	<b>5</b>
<b>CONNECTIONS</b>	<b>6</b>
<b>TECHNICAL SPECIFICATIONS</b>	<b>7</b>
<b>TROUBLESHOOTING</b>	<b>7</b>

This guide is designed to make installing and using this product as easy as possible. Information in this document has been carefully checked for accuracy at the time of printing; however, Cambridge Audio's policy is one of continuous improvement, therefore design and specifications are subject to change without prior notice.

This document contains proprietary information protected by copyright. All rights are reserved. No part of this manual may be reproduced by any mechanical, electronic or other means, in any form, without prior written permission of the manufacturer. All trademarks and registered trademarks are the property of their respective owners.

© Copyright Cambridge Audio Ltd 2019.

**Make sure you register your product at:**  
**[WWW.CAMBRIDGEAUDIO.COM/REGISTER](http://WWW.CAMBRIDGEAUDIO.COM/REGISTER)**

For upcoming news on future products, software updates and exclusive offers.

# Important safety instructions

For your own safety please read the following important safety instructions carefully before attempting to connect this unit to the mains power supply. They will also enable you to get the best performance from and prolong the life of the unit:

1. Read these instructions.
2. Keep these instructions.
3. Heed all warnings.
4. Follow all instructions.
5. Do not use this apparatus near water.
6. Clean only with a dry cloth.
7. Do not block any ventilation openings. Install in accordance with the manufacturer's instructions.
8. Do not install near any heat sources such as radiators, heat registers, stoves, or other apparatus (including amplifiers) that produce heat.
9. Do not defeat the safety purpose of the polarized or grounding-type plug. A polarized plug has two blades with one wider than the other. A grounding-type plug has two blades and a third grounding prong. The wide blade or the third prong are provided for your safety. If the provided plug does not fit into your outlet, consult an electrician for replacement of the obsolete outlet.
10. Protect the power cord from being walked on or pinched, particularly at plugs, convenience receptacles and the point where they exit from the apparatus.
11. Only use attachments/accessories specified by the manufacturer.
12. Use with only the cart, stand, tripod, bracket, or table specified by the manufacturer, or sold with the apparatus. When a cart is used, use caution when moving the cart/ apparatus combination to avoid injury from tip-over. 
13. Unplug this apparatus during lightning storms or when unused for long periods of time.
14. Refer all servicing to qualified service personnel. Servicing is required when the apparatus has been damaged in any way, such as the power-supply cord or plug having been damaged, liquid has been spilled or objects have fallen into the apparatus, the apparatus has been exposed to rain or moisture, does not operate normally, or has been dropped.

**WARNING:**

- Do not place the unit in an enclosed space; if you wish to place the unit on a shelf, use the top shelf to allow maximum ventilation. Do not put any objects on top of this unit. Do not situate it on a rug or other soft surface and do not obstruct any air inlets or outlet grilles. Do not cover the ventilation grilles with items such as newspapers, tablecloths, curtains, etc.
- To reduce the risk of fire or electric shock, do not expose this apparatus to rain or moisture. This unit must not be used near water or exposed to dripping or splashing water or other liquids. No objects filled with liquid, such as vases, shall be placed on the unit.
- Danger of explosion if battery is incorrectly replaced. Replace only with the same or equivalent type.
- The battery (battery pack or batteries installed) shall not be exposed to excessive heat such as sunshine, fire or the like.
- The unit must be installed in a manner that makes disconnection of the mains plug from the mains socket outlet (or appliance connector from the rear of the unit) possible. Where the mains plug is used as the disconnect device, the disconnect device shall remain readily operable.
- Please refer to the information on the exterior rear panel for electrical and safety information before installing or operating the apparatus.
- Only use the mains cord supplied with this unit.

Use of the apparatus in tropical climates - The equipment shall be used at a maximum 45 degree C ambient temperature.



The lightning flash with the arrowhead symbol within an equilateral triangle is intended to alert the user to the presence of un-insulated 'dangerous voltage' within the product's enclosure that may be of sufficient magnitude to constitute a risk of electric shock to persons.

The exclamation point within an equilateral triangle is intended to alert the user to the presence of important operating and maintenance instructions in the service literature relevant to this appliance.

The exclamation point within an equilateral triangle is intended to alert the user to the presence of important operating and maintenance instructions in the service literature relevant to this appliance.



The symbol on this product indicates that it is of CLASS II (double insulated) construction.



**WEEE SYMBOL**

The crossed-out wheeled bin is the European Union symbol for indicating separate collection for electrical and electronic equipment. This product contains electrical and electronic equipment which should be reused, recycled or recovered and should not be disposed of with unsorted regular waste. Please return the unit or contact the authorised dealer from whom you purchased this product for more information.



**CE MARK**

This product complies with European Low Voltage (2014/35/EU), Electromagnetic Compatibility (2014/30/EU) and Environmentally-friendly design of Energy-related Products (2009/125/EC) Directives when used and installed according to this instruction manual. For continued compliance only Cambridge Audio accessories should be used with this product and servicing must be referred to qualified service personnel.



**RCM (REGULATORY COMPLIANCE MARK)**

This product meets Australia, New Zealand Safety, EMC and Radio Communications requirements of the ERAC and ACMA.

**FEDERAL COMMUNICATIONS COMMISSION NOTICE:**

This equipment has been tested and found to comply with the limits for a Class B digital device, pursuant to Part 15 of the FCC Rules. These limits are designed to provide reasonable protection against harmful interference in a residential installation.

This equipment generates, uses, and can radiate radio frequency energy, and if not installed and used in accordance with the instructions, may cause harmful interference to radio communications. However, there is no guarantee that interference will not occur in a particular installation.

If this equipment does cause harmful interference to radio or television reception, which can be determined by turning the equipment off and on, the user is encouraged to try and correct the interference by one or more of the following measures:

- Reorient or relocate the receiving antenna.
- Increase the distance between the equipment and the receiver.
- Connect the equipment to an outlet on a circuit different from that to which the receiver is connected.
- Consult the dealer or an experienced radio/TV technician for help.

FCC Caution: Any changes or modifications not expressly approved by the party responsible for compliance could void the user's authority to operate this equipment.

## SUPPLIER'S DECLARATION OF CONFORMITY (SDOC)

Equipment: Integrated Amplifier  
Model: AXA25  
Trademark: Cambridge Audio

This device complies with Part 15 of the FCC Rules. Operation is subject to the following two conditions: (1) this device may not cause harmful interference, and (2) this device must accept any interference received, including interference that may cause undesired operation.

The responsible party in US:

Company name: Audio Partnership LLC

Address: 1913 N Milwaukee Ave. Chicago, IL 60647

Phone: (312) 636-4817

Legal Representative Person: Gregg Chopper

Signature:

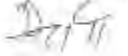

## VENTILATION

Important! The unit will become hot when in use. Do not stack multiple units on top of each other.

Ensure that small objects do not fall through any ventilation grille. If this happens, switch off immediately, disconnect from the mains supply and contact your dealer for advice.

## POSITIONING

Choose the installation location carefully. Avoid placing it in direct sunlight or close to a source of heat. No naked flame sources, such as lighted candles, should be placed on the unit. Also avoid locations subject to vibration and excessive dust, cold or moisture. The unit can be used in a moderate climate.

This unit must be installed on a sturdy, level surface. Do not place in a sealed area such as a bookcase or in a cabinet. Do not place the unit on an unstable surface or shelf. The unit may fall, causing serious injury to a child or adult as well as serious damage to the product. Do not place other equipment on top of the unit.

Due to stray magnetic fields, turntables or CRT TVs should not be located nearby due to possible interference.

Electronic audio components have a running in period of around a week (if used several hours per day). This will allow the new components to settle down and the sonic properties will improve over this time.

## POWER SOURCES

The unit should be operated only from the type of power source indicated on the marking label. If you are not sure of the type of power-supply to your home, consult your product dealer or local power company.

If you do not intend to use this unit for a long period of time, unplug it from the mains socket.

## OVERLOADING

Do not overload wall outlets or extension cords as this can result in a risk of fire or electric shock. Overloaded AC outlets, extension cords, frayed power cords, damaged or cracked wire insulation and broken plugs are dangerous. They may result in a shock or fire hazard.

Be sure to insert each power cord securely. To prevent hum and noise, do not bundle the interconnect leads with the power cord or speaker leads.

## CLEANING

To clean the unit, wipe its case with a dry, lint-free cloth. Do not use any cleaning fluids containing alcohol, ammonia or abrasives. Do not spray an aerosol at or near the unit.

## BATTERY DISPOSAL

Batteries may contain substances harmful to the environment. Please dispose of any discharged batteries with due consideration and in accordance with local environmental/electronic recycling guidelines.

## SERVICING

These units are not user serviceable. Never attempt to repair, disassemble or reconstruct the unit if there seems to be a problem. A serious electric shock could result if this precautionary measure is ignored. In the event of a problem or failure, please contact your dealer.

## PLUG FITTING INSTRUCTIONS (UK ONLY)

The cord supplied with this appliance is factory fitted with a UK mains plug fitted with a 3 amp fuse inside. If it is necessary to change the fuse, it is important that a 3 amp one is used. If the plug needs to be changed because it is not suitable for your socket, or becomes damaged, it should be cut off and an appropriate plug fitted following the wiring instructions below. The plug must then be disposed of safely, as insertion into a mains socket is likely to cause an electrical hazard. Should it be necessary to fit a 3-pin BS mains plug to the power cord the wires should be fitted as shown in this diagram. The colours of the wires in the mains lead of this appliance may not correspond with the coloured markings identifying the terminals in your plug. Connect them as follows:

The wire which is coloured BLUE must be connected to the terminal which is marked with the letter 'N' or coloured BLACK.

The wire which is coloured BROWN must be connected to the terminal which is marked with the letter 'L' or coloured RED.

The wire which is coloured GREEN/YELLOW must be connected to the terminal which is marked with the letter 'E' or coloured GREEN.

If a 13 amp (BS 1363) plug is used, a 3 amp fuse must be fitted, or if any other type of plug is used a 3 amp fuse must be fitted, either in the plug or adaptor, or on the distribution board.

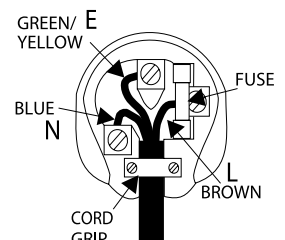

# Rear panel connections

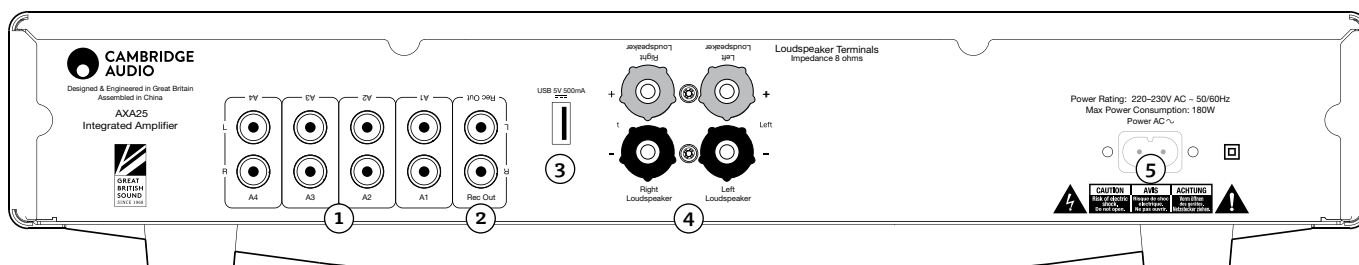

## ① AUDIO INPUTS (A1-A4)

These inputs are suitable for any 'line level' source equipment such as the audio outputs of CD players, streaming devices such as a Chromecast Audio (RCA Phono to jack cable required) etc.

## ② REC OUT

Connect to the recording input of a CD recorder input, tape deck or other compatible recording device etc.

This output provides a constant high level output that does not fluctuate with the volume, balance or tone controls of the main unit. For this reason, the AXA25 cannot be used as a Preampifier only or with a subwoofer.

## ③ USB POWER 5V 500MA

This USB connection is designed for charging or maintaining power to a device such as a Streaming device or Bluetooth adaptor.

Note: This is not an input so will not allow you to play audio directly to the unit.

## ④ LOUDSPEAKER TERMINALS

Connect the wires from your left channel loudspeaker to the Left positive and negative terminals and the wires from the right channel loudspeaker to the Right positive and negative terminals.

In each case, the red terminal is the positive output and the black terminal is the negative output.

Care should be taken to ensure no stray strands of wire are accidentally connecting speaker outputs together as this may cause damage to the unit.

Please ensure that the loudspeaker terminals have been tightened adequately to provide a good electrical connection. It is possible for the sound quality to be affected if the screw terminals are loose.

## ⑤ AC POWER SOCKET

Once all connections are complete, plug the AC power cable into an appropriate mains socket and turn the unit on.

Please only use the power lead supplied with the unit.

# Front panel controls

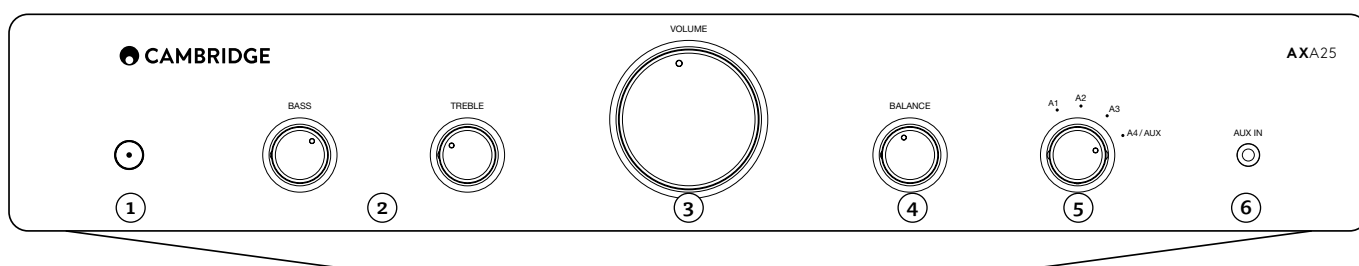

## ① POWER BUTTON

Switches the unit between Standby mode (indicated by dim LED) and On (indicated by bright LED). Standby mode is a low power mode where the power consumption is less than 0.5 Watts.

This product has APD (Auto Power Down) enabled as default. After inactivity of 20 minutes, the product will automatically switch to Standby.

### Auto Power Down (APD)

You can enable and disable the units APD setting. This can be adjusted by pressing and holding the Power button until the LED flashes in sequence. The two options below show which option is selected.

Standby flashes 5 times - APD disabled  
Standby flashes 10 times - APD enabled

Note: Make sure the unit is On, before making changes to the APD function.

## ② BASS AND TREBLE

These controls allow subtle adjustments to the tonal balance of the sound. In the central position these controls have no effect. They only modify the sound through your loudspeakers, and do not affect the signals sent through the Rec Out connections. If the musical recording is of poor quality or other factors are affecting the sound quality, it may be necessary to adjust the tone controls to compensate.

## ③ VOLUME CONTROL

Use to increase or decrease the audio output level of the unit.

Note: The volume control does not affect the level of the 'Rec Out' output as this has a fixed level

## ④ BALANCE

This control allows you to adjust the relative output levels of the left and right channels. In the central position the output from each channel is equal. This control only modifies the sound through your loudspeakers - it does not affect the signals sent through the Rec Out connections.

## ⑤ SOURCE SELECTOR SWITCH (A1, A2, A3 AND A4/AUX)

Select the appropriate input source component that you wish to listen to. The signal selected is also fed to the Rec Out sockets so that it may be recorded. The input should not be changed whilst recording.

## ⑥ AUX IN

This source input allows you to connect a portable audio device such as an MP3 player or streaming device directly into the front of the unit using a 3.5mm stereo Aux lead.

Once plugged in, this input is automatically selected, although other inputs apart from A4 can still be selected once a stereo-jack is plugged in. The A4/AUX option on the front of the unit will select this input whilst a stereo-jack is plugged in.

Note:

- Plugging a source into the front panel Aux input overrides the A4 input. Simply remove the jack from the front panel to automatically re-enable the A4 input.

# Connections

## LOUDSPEAKERS

Check the impedance of your speakers. You can use types with an impedance of 8 Ohms.

The red coloured speaker terminals are positive (+) and the black speaker terminals are negative (-). Make sure correct polarity is maintained at each speaker connector or the sound can become weak and “phases” with little bass.



## USING BARE WIRE CONNECTIONS

Prepare the speaker cords for connection by stripping off approximately 10mm (3/8”) or less of the outer insulation. More than 10mm could cause a short circuit. Twist the wires tightly together so there are no loose ends. Unscrew the speaker terminal, insert the speaker cable, tighten the terminal and secure the cable.

Note: All connections are made using standard loudspeaker cable.

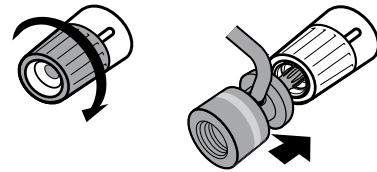

## USING BANANA PLUGS

We recommend using Banana plugs with our units to establish a secure connection and ensure there are no loose strands of wire that may cause unwanted noise or interference.

Once you have stripped the outer insulation of the cable and twisted the wires as indicated above, securely connect these to your banana plugs, remove the dust cap from the end of the speaker terminal and push the plug in as far as possible without applying excessive force.

## BASIC CONNECTION

The diagram below shows the basic connection of your amplifier to a CD player and a pair of loudspeakers.

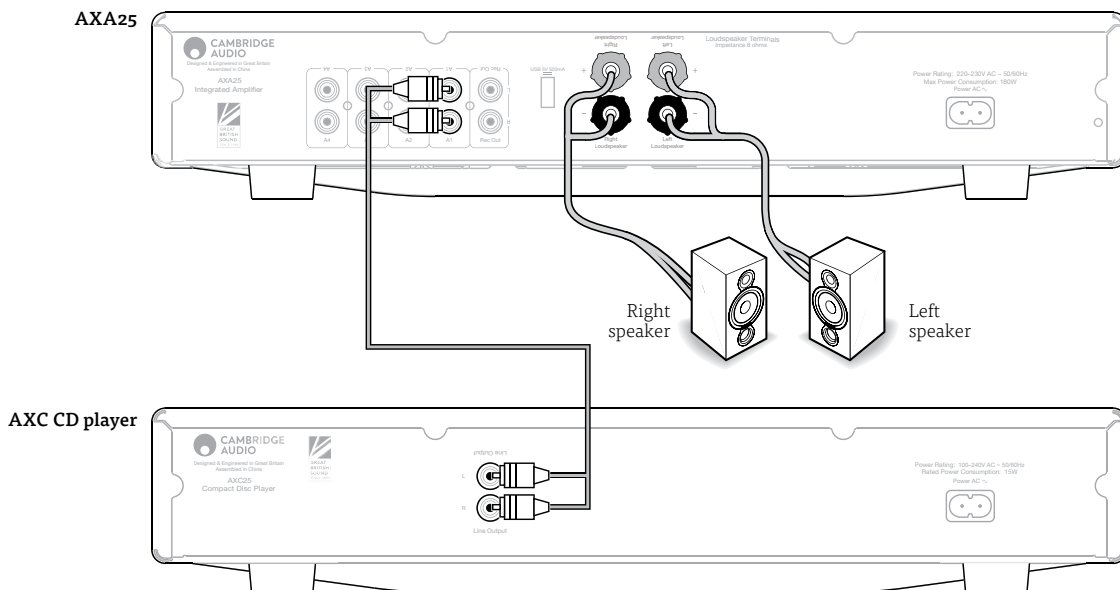

# Technical specifications

Power output	25 watts (into 8Ω)
THD (unweighted)	<0.015% @ 1kHz, 80% of rated power <0.15% 20Hz – 20kHz, 80% of rated power <0.1% 20Hz – 20kHz @ 10W
Frequency response (-3dB)	(-3dB) 10Hz - 30kHz
S/N ratio (ref 1W)	>82dB (unweighted)
Input impedances	32k ohms
Power Amp damping factor	> 100
Max. power consumption	180W
Bass/Treble controls	Shelving, ultimate boost/cut +/- 5.5dB @ 20Hz and 20kHz
Standby power consumption	<0.5W
Inputs:	4x RCA, , 1 x 3.5mm Aux input (front panel)
Outputs:	Speakers, Rec Out, USB 5V power
Dimensions (HxWxD):	83 x 430 x 340mm (3.3 x 16.9 x 13.4")
Weight:	5.1kg (11.2lbs)

# Troubleshooting

## THERE IS NO POWER

Ensure the AC power cord is connected securely.

Ensure the plug is fully inserted into the wall socket and is switched on. Check fuse in the mains plug or adaptor.

Check the power button is on at the front of the unit.

## THERE IS NO SOUND

Check the correct input is selected.

Check that the speakers are connected correctly.

## THE SOUND IS DISTORTED

Check speaker connections.

## THERE IS A HUM COMING FROM THE SPEAKER

Ensure that all cable connections are secure.

## THERE IS UNWANTED BACKGROUND NOISE AND INTERFERENCE

Move the unit away from other electrical equipment that is likely to cause interference.

Ensure that all cable connections are secure.

If you experience any trouble with your product, visit the help section on our webpage at <https://techsupport.cambridgeaudio.com>

For all servicing, in or out of warranty, please contact your dealer.

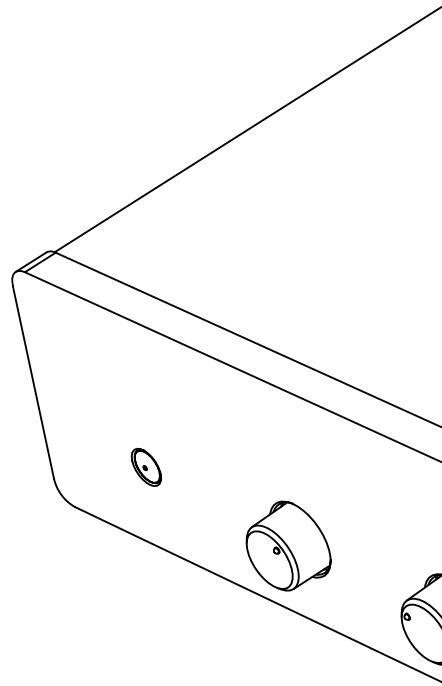

[WWW.CAMBRIDGEAUDIO.COM](http://WWW.CAMBRIDGEAUDIO.COM)

Gallery Court, Hankey Place  
London  
SE1 4BB  
United Kingdom

Cambridge Audio is a brand of Audio Partnership Plc.  
Registered in England No. 2953313

AP36593/1