

MANUALE D'USO

FRULLATORE

IT

INSTRUCTION MANUAL

BLENDER

EN

MANUEL D'UTILISATION

MIXEUR

FR

GEBRAUCHSANWEISUNG

STANDMIXER

DE

GEBRUIKSAANWIJZING

BLENDER

NL

MANUAL DE USO

LICUADORA

ES

MANUAL DE UTILIZAÇÃO

LIQUIDIFICADOR

PT

BRUKSANVISNING

MIXER

SV

РУКОВОДСТВО ПО ЭКСПЛУАТАЦИИ

БЛЕНДЕР

RU

BRUGERVEJLEDNING

BLENDER

DA

INSTRUKCJA UŻYTKOWNIKA

BLENDER KIELICHOWY

PL



Dear Customer,

Thank you for purchasing a Smeg 50's Style blender.

By choosing one of our products, you have selected an appliance which combines iconic style with innovative technical design and attention to detail.

This appliance co-ordinates perfectly with other Smeg products, or works equally great as a standalone statement piece in your kitchen.

We hope you enjoy using your new appliance!

For any further information please visit: www.smeg50style.com or www.smeg.com.

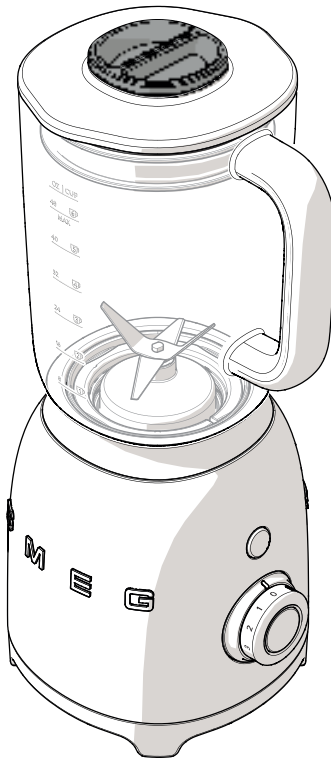

Model BLF01
Blender

Contents

1	Instructions	28
1.1	Introduction	28
1.2	This user manual	28
1.3	Intended use	28
1.4	General safety instructions	29
1.5	Manufacturer liability	31
1.6	Identification plate	31
1.7	Disposal	31
2	Description	32
2.1	Product description	32
2.2	Description of parts	33
3	Use	36
3.1	Before first use	36
3.2	How to remove the blade assembly	36
3.3	Using the blender	38
3.4	Functions	41
3.5	Speed setting suggestions	42
4	Cleaning and care	44
4.1	Instructions	44
4.2	Cleaning the motor base	44
4.3	Cleaning the blender jug and blade assembly	44
4.4	Using the Self-clean option	44
4.5	Cleaning other blender parts	44
4.6	What to do if...	45
5	Recipes	47

We advise you to read this manual carefully, as it contains all the instructions for maintaining the appliance's aesthetic and functional qualities.

For further information on the product: www.smeg.com



Instructions

1 Instructions

1.1 Introduction

Key information for the user:

Instructions



General information on this user manual, on safety and final disposal.

Description



Appliance description.

Use



Information on using your appliance

Cleaning and care



Information for proper cleaning and maintenance of the appliance.

Recipes



List of recipes



Safety instructions



Information



Advice

1.2 This user manual

This user manual is an integral part of the appliance and must therefore be kept in its entirety and within the user's reach for the whole working life of the appliance.

1.3 Intended use

- Use the appliance only indoors.
- This appliance has been designed specifically for domestic use. It must only be used for blending, emulsifying ingredients and crushing ice. Do not use the appliance for anything other than its intended use.
- This appliance is intended for use in a home environment. Every other use is considered improper. It also can be used in:
 - staff kitchen areas in shops, offices and other working environments;
 - farm houses;
 - by guests in hotels, motels and other residential type environments;
 - bed and breakfast type environments.
- The appliance is not designed to operate with external timers or with remote-control systems.
- This appliance may not be used by people of reduced physical and mental capacity, or without sufficient experience and knowledge (including children), unless they are supervised or instructed by adults who are responsible for their safety.
- Children must never play with the appliance. Keep the appliance out of children's reach.



1.4 General safety instructions

Follow all safety instructions in order to be able to use the appliance safely.

- Read this user manual carefully before using the appliance.
- Switch off the appliance immediately after use.
- Do not leave the appliance unattended while it is operating.
- Disconnect the appliance from the power socket as soon as you have finished using it and before cleaning it.
- Do not immerse the appliance, the power cord or the plug in water or any other liquid.
- Do not use the appliance when the power cord or the plug is damaged or when the appliance has been dropped or is damaged in any manner.
- If the supply cord is damaged, it must be replaced by the service agent in order to avoid a hazard.
- The cable is short to prevent accidents. Do not use an extension cord.
- Ensure the cord does not come into contact with sharp edges.
- Do not pull on the cord to unplug it from the power socket.
- Do not place the appliance above or near lit hob burners or electric rings, inside an oven or near other heat sources.
- Do not try to repair the appliance yourself or without the intervention of a qualified engineer.
- In the event of a fault, repairs should only be carried out by a qualified engineer.
- Do not modify the appliance.
- Never try to put out a fire or flames with water: turn off the appliance and remove the plug from the socket and smother the flames with a fire blanket or other appropriate cover.
- Disconnect the appliance from the power socket as soon as you have finished using it and before cleaning it.



Instructions

For this appliance

- Avoid touching moving parts. Keep hands, hair and clothing, and utensils away from the blades during operation, to prevent personal injury and/or damage to the appliance.
- Care shall be taken when handling and emptying the jug and during cleaning.
- Always disconnect the blender from the supply if it is left unattended and before assembly, disassembly or cleaning. Unplug the blender when it is not being used, before cleaning it and if you notice any fault. Let the appliance cool down before cleaning.
- Always use the blender with the lid in place.
- Check that the lid is correctly closed before turning on the blender.
- Do not overfill the blender (max. 1.5 litres).
- Do not use the blender with parts or accessories of other manufacturers.
- Only use original spare parts. The use of spare parts not approved by the manufacturer could lead to fires, electric shocks or personal injury.
- Only place the blender on level and dry surfaces.
- Do not run the blender empty.
- Do not use the blender as a storage compartment. Keep it empty before and after use.
- Let liquids cool down to room temperature before placing them in the blender.
- Avoid touching moving parts, such as the blade assembly.
- To avoid the risk of cuts, and damage to the blender, do not put your hands or tools like cutlery, etc. into the blender jug while it is operating. You can use a wood or plastic spatula only when the blender is off.
- Do not use harsh detergents or sharp objects to wash or remove residues from the blender jug.



1.5 Manufacturer liability

The manufacturer shall not be liable for damage to persons or property caused by:

- Use of the appliance other than as envisaged
- Not having read the user manual
- Tampering with any part of the appliance
- Use of non-original spare parts
- Failure to observe the safety instructions

1.6 Identification plate

The identification plate bears the technical data, serial number and brand name of the appliance. Do not remove the identification plate for any reason.

1.7 Disposal



This appliance must be disposed of separately from other waste (Directive 2012/19/EU). The appliance does not contain substances in quantities sufficient to be considered hazardous to health and the environment, in accordance with current European directives.

- **Old appliances do not belong in household waste!** To comply with current legislation, old appliances, on reaching the end of their useful lives, should be taken to a disposal facility where they can be sorted. In this way, any valuable material contained in the old appliances can be recycled, helping to protect the environment. The relevant local authorities or their waste disposal operators can provide further information.

The appliance is packed in non-polluting and recyclable materials.

- Dispose of the packing materials at an appropriate disposal facility.



Plastic packaging Danger of suffocation

- Do not leave the packaging or any part of it unattended.
- Do not let children play with the plastic bags.



Electrical voltage Danger of electrocution

- Disconnect the main power supply.
- Disconnect the power cable from the electrical system.



Description

2 Description

2.1 Product description

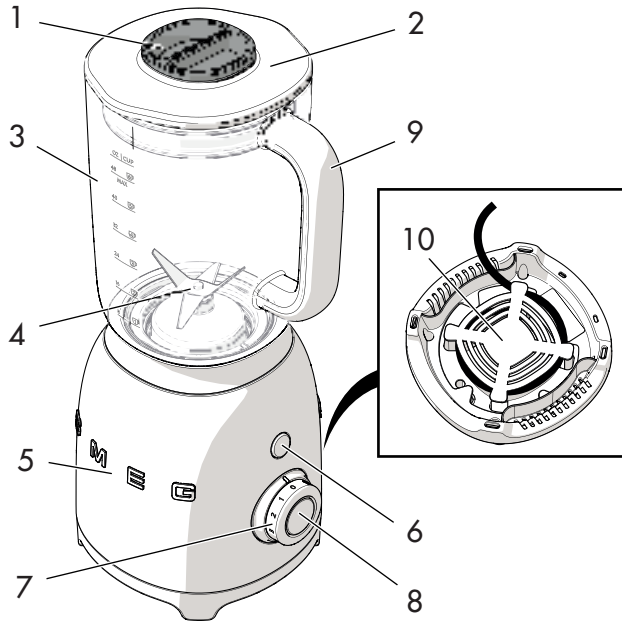

Model BLF01 - Blender

- 1 Measuring cup
- 2 Lid with pouring hole
- 3 1.5 litre Tritan™ BPA-Free jug
- 4 Detachable blade assembly
- 5 Motor base
- 6 Pulse button
- 7 Control knob
- 8 START/STOP button
- 9 Handle
- 10 Built-in cord wrap



2.2 Description of parts

Measuring cup (1)

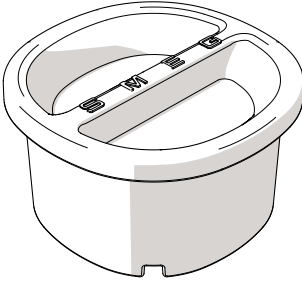

Convenient measuring cup. It can be used for measuring ingredients and as a device to unscrew the blade assembly from the base of the jug. See "3.2 How to remove the blade assembly".

Lid with pouring hole (2)

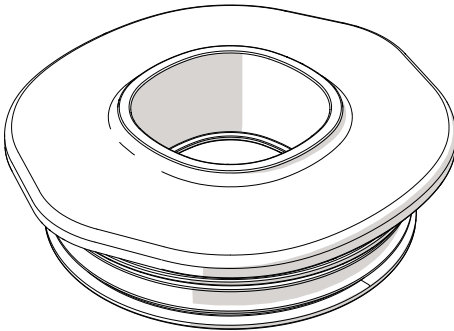

The lid has a seal that closes the blender jug tightly. It has a pouring hole in the centre to make the addition of ingredients easier during blender operation.

1.5 litre Tritan™ BPA-Free jug (3)



The large-capacity jug is made of Tritan™, which is a safer, lighter and easier to handle material than glass. Tritan™ is also resistant to impacts, scratches and heat.

The jug features a handy lip and is marked in both litres and cups.

It has a capacity that ranges from a minimum of 0.25 l (1 cup) to a maximum of 1.5 litres (6 cups).



Description

Detachable blade assembly (4)

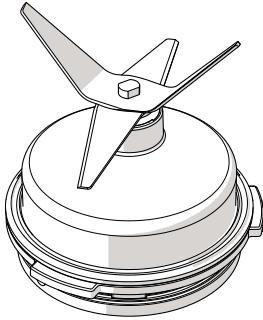

Stainless steel detachable blade to crush ice cubes and prepare delicious smoothies, milkshakes, cocktails, etc.

It can be unscrewed from the base of the jug to be cleaned.



Sharp blades

Danger of cuts

- Never touch the blades with your hands.
- Remove the blade assembly only using the measuring cup, as indicated in section "3.2 How to remove the blade assembly".



The accessories intended to come into contact with food are made of materials that comply with the provisions of current legislation.

Motor base (5)

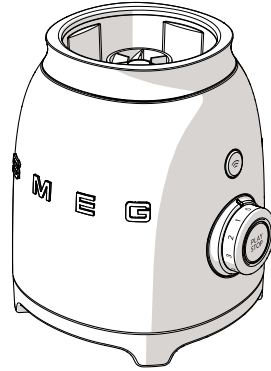

The base houses a powerful 800 watt motor.



To avoid damage to the blender, the appliance is equipped with a **safety lock system** which shuts off its operation when the jug is removed. It also features a **motor safety cut-out** which trips if the motor is overloaded.



Pulse button (6)

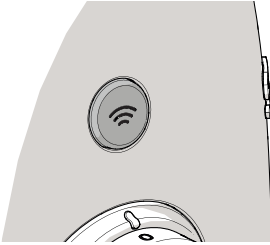

Press this button to get the maximum blending speed. Perfect for most demanding tasks. It can be used for a maximum of 2 seconds at a time.

START/STOP button (8)

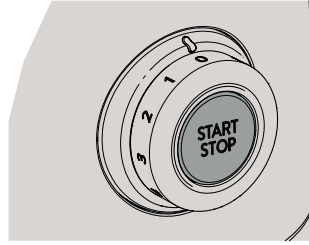

Press this button to start/stop blender operation.

Control knob (7)

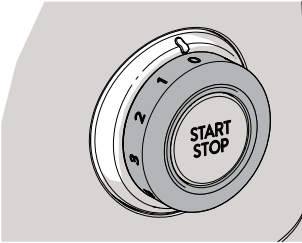

The control knob allows you to select one of the four speeds available from 1 to 4. The control knob features also 2 pre-set programs: smoothie and ice crush. See "3.5 Speed setting suggestions" for further information on which speed to use.



3 Use



Danger of electrocution

- Plug into a earthed 3-prong outlet.
- Do not remove the earth prong.
- Do not use an adapter.
- Do not use an extension cord.
- Failure to follow these instructions could result in death, fire, or electrical shock.

3.1 Before first use

1. Remove all stickers and labels from the blender and clean the motor base with a damp cloth.
2. Remove the blender jug.
3. Remove the blade assembly (see "3.2 How to remove the blade assembly").
4. Wash and dry thoroughly (see "4.3 Cleaning the blender jug and blade assembly").



Danger of sudden start-up

- Make sure the blender is unplugged before fitting or removing the blade assembly.

3.2 How to remove the blade assembly

1. Take hold of the handle (1) and lift the blender jug.

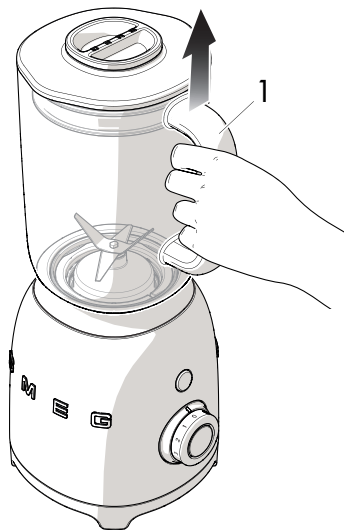

2. Remove the lid (2) from the blender jug and the measuring cup (3) from the lid.

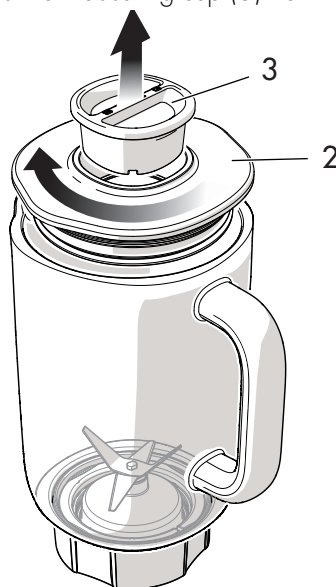



3. Turn the jug upside down and place it on a flat surface. Insert the open end of the measuring cup (3) into the base of the blade assembly.

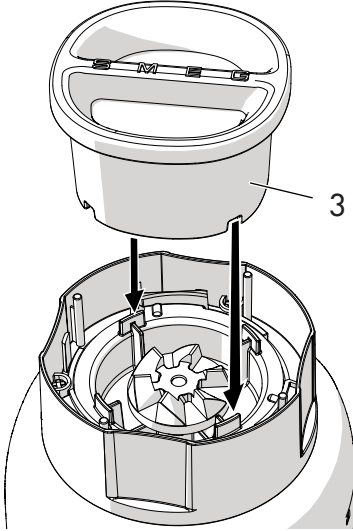

4. Unscrew the blade assembly (4) from the jug body, turning the measuring cup anti-clockwise. Manually remove the blade assembly (4) from the jug body.

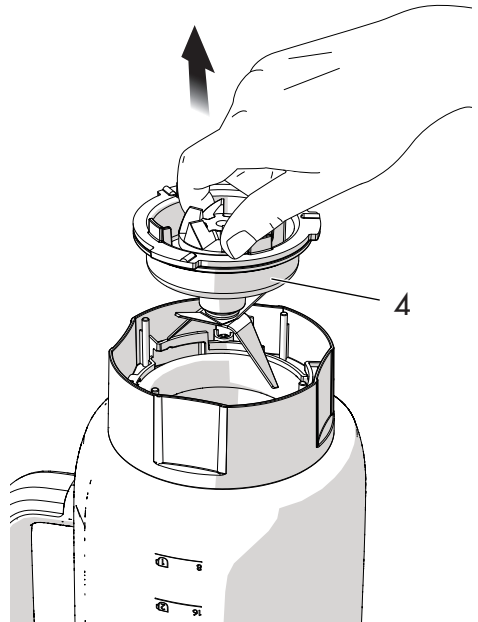
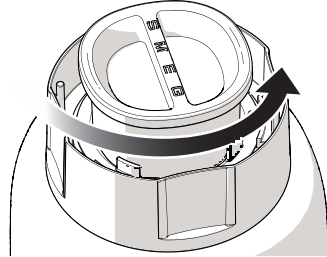



5. Wash the jug, measuring cup, and blade assembly in warm soapy water or in the dishwasher (apart from the blade assembly). Dry thoroughly and replace the blade assembly into the jug body following the operations indicated previously in the reverse order. Make sure to insert the blade assembly until it locks into place.

3.3 Using the blender

1. Insert the blender jug onto the motor base.



2. Introduce the ingredients into the jug, paying attention not to exceed the maximum capacity (1.5 l - 6 cups).

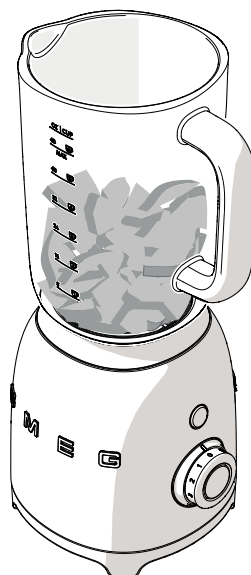



3. Position the lid with the measuring cup fitted onto the blender jug. Ensure the lid is firmly screwed on.



4. Plug the blender into a power socket and switch the socket on. The red LED will turn on to indicate the presence of power. Select the desired speed or a pre-set program using the control knob or press the **PULSE** button to operate it manually.

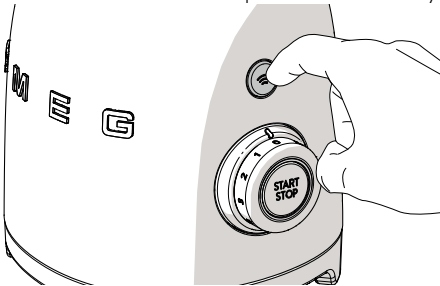

The **PULSE** button can be used alone or in combination with speeds 1 to 3 to reach the maximum speed.

5. Press the **START** button to start blending. See the table "3.5 Speed setting suggestions" for further information on the most suitable speed to use.

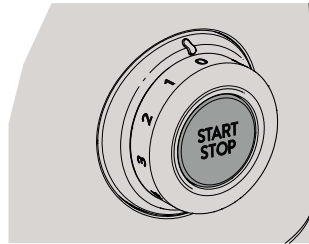

Speeds 1 - 4 allow continuous blending. You can stop the operation by pressing the **STOP** button.

The speed can be changed at any time during the blending process.



Important

- Do not operate manual speeds 1-4 for more than 1 minute at a time.
- When the blender jug is filled up to or near the maximum capacity (1.5 l), place one hand on the blender lid to avoid displacement of the lid during operation.



Use

6. You can add further ingredients whilst blending by removing the measuring cup and pouring ingredients through the hole in the lid.



7. If you have selected a speed between 1 and 4, when you have finished blending, press the **STOP** button, turn the knob to '0' and unplug the blender.

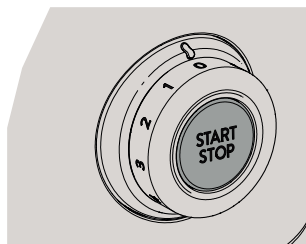

labelling Cancellling/stopping the blending cycle

The blending cycle can be cancelled or stopped at any time pressing the **START/STOP** button.



3.4 Functions

Safety lock system

The blender has a safety lock system which automatically shuts off the blender when the jug is removed from the base. It also features a **motor safety cut-out** which trips if the motor is overloaded.

Smooth Start

The Smooth Start function starts the appliance up with a reduced initial speed, regardless of the speed set with the control knob.

The speed progressively increases until the set speed is reached.

The Smooth Start function allows you to process ingredients gradually to improve the blending results.



The Smooth Start only works when a speed between 0 and 4 is selected and does not work with the **PULSE** mode, **ICE CRUSH** or **SMOOTHIE** programs.

PULSE function

Pressing the **PULSE** button operates the blender at maximum speed.

The blender shuts off immediately when the button is released.

You should use a minimum quantity of 100g, not blending for more than 5 seconds consecutively, or 2 seconds when using dry ingredients.



The **PULSE** function does not work in combination with the **ICE CRUSH** or **SMOOTHIE** programs.

Ice Crush and Smoothie

The pre-set 'Ice Crush' and 'Smoothie' programs automatically adjust the speed to optimise blending results for a certain factory set time, then turn off automatically.

Use the **ICE CRUSH** program with short bursts of power when blending drinks containing ice cubes or frozen fruit.

Use the **SMOOTHIE** program to blend fruits, ice cream and yoghurt into thick smoothies, blended drinks and milkshakes.

Pre-set time

Ice crush: approximately 50 seconds



Smoothie: approximately 60 seconds

When one of the two above mentioned pre-set programs is selected, and after you have pressed the **START** button, the blender will automatically start to operate and the central knob LED lights up to indicate that the cycle is activated.



Use

3.5 Speed setting suggestions

Speed	Suitable for
 PULSE	<ul style="list-style-type: none">• Ice cubes• Meat• Breadcrumbs• Biscuits• Nuts (shelled)• Coffee beans• Self-clean option ("4.4 Using the Self-clean option").
1 or 2	<ul style="list-style-type: none">• Mousses/Sorbets• Batters/Salad dressings• Blended frozen drinks
3 or 4	<ul style="list-style-type: none">• Soups/Creamed soups• Whipped cream• Milkshakes/Smoothies• Pesto/Fruit or vegetable purées
 SMOOTHIES	<ul style="list-style-type: none">• Smoothies and milkshakes• Smoothies with frozen fruit
 ICE CRUSH	<ul style="list-style-type: none">• Ice cubes• Pieces of frozen fruit/vegetables



The speeds indicated in the table are approximate and can vary depending on the recipe and on the interaction of the different ingredients used.



Tips for using your blender

- Cut into cubes the food to be blended to obtain better results.
- Use the **PULSE** function for no more than 2 seconds at a time when blending dry mixtures. You might need to stop operation to push the ingredients down the sides of the blender jug with a spatula.
- When making bread crumbs, it is better to use 2 or 3 day old bread leaving the crusts on. If only have fresh bread, dry it out in an oven at low temperature for just a few minutes.
- When blending together liquid and dry ingredients, blend liquids first and then add the dry ingredients.
- Always remove stones from fruit and bones from meat as they can damage the blade assembly.
- Do not leave food residues dry on the jug and blades for too long, as they could be very difficult to remove. If you cannot clean it right away, pour a little warm water and let it soak.
- Do not process hot or warm food. Let it cool to room temperature before blending.



4 Cleaning and care

4.1 Instructions



Improper use Danger of electrocution

- Unplug the blender before cleaning it.
- Do not immerse the motor base in water or other liquids.



Improper use Risk of damage to surfaces

- Do not use steam jets to clean the appliance.
- Do not use cleaning products containing chlorine, ammonia or bleach on parts with metallic finishes (e.g. anodised, nickel- or chrome-plated).
- Do not use abrasive or corrosive detergents (e.g. powder products, stain removers and metallic scourers).
- Do not use rough or abrasive materials or sharp metal scrapers.

4.2 Cleaning the motor base

To keep the blender's motor base outside surfaces in good condition, they should be cleaned regularly after use. Use a damp and soft cloth with mild detergent.

4.3 Cleaning the blender jug and blade assembly

Clean the appliance following the instructions in section "3.2 How to remove the blade assembly".



Sharp blades Danger of cuts

- Never touch the blades with your hands.
- Remove the blade assembly only using the measuring cup.

4.4 Using the Self-clean option

The blender jug and blade assembly can be cleaned using the Self-clean option:

1. Fill the jug with warm water and mild detergent.
2. Turn the control knob to the setting **1**.
3. Press the **START** button.
4. Press the **PULSE** button for 2 seconds at a time. Repeat the operation about 10 times.
5. Remove the jug, empty and rinse it.
6. Dry thoroughly.

4.5 Cleaning other blender parts

The blender lid and measuring cup can be washed in warm soapy water or in the dishwasher.

Make sure they have dried completely before fitting them back on the blender.



4.6 What to do if...

Problem	Possible cause	Solution
The motor will not start	The motor has overheated.	Unplug the blender and leave the motor to cool.
	The plug is not properly inserted in the power socket.	Insert the plug into the power socket. Do not use adaptors or extensions. Check that the house main breaker is on.
	The cable is defective.	Contact an Authorised Service Centre.
	Lack of power.	Check that the house main breaker is on.
The blender vibrates	The blender is not resting on a stable surface.	Place the blender on a flat, stable surface.
	The anti-slip rubber feet are worn.	Have them replaced at an Authorised Service Centre.
	The speed used is too high or the load is excessive	Set a lower speed and ensure the jug has not been overfilled.

NE



Cleaning and care

Problem	Possible cause	Solution
The blender switches on, but the blades do not turn	The jug has not been correctly locked into its base.	Remove the jug from its base and lock it into place.
The blender stops while operating	The motor has overheated.	Unplug the blender and leave the motor to cool.
The red LED flashes at regular intervals	The jug is not correctly inserted in the base.	Check the position of the jug on the base.
The blender stops during operation and the white LED flashes	The blades may have jammed.	Unplug the blender and free the blades with a spatula.



If the problem has not been resolved or in the event of another type of fault, contact your local technical support centre.



5 Recipes

Mixed fruit smoothie

Ingredients:

- 2 nectarines, stones removed (or tinned peaches in syrup) and cut into pieces
- 125 g frozen raspberries
- 125 g frozen strawberries
- 125 ml orange juice
- 125 ml apple juice

Method

1. Put the nectarine pieces and the juices into the blender jug.
2. Add the frozen fruit.
3. Turn the control knob to the **Smoothie** program and start the blender by pressing the **START** button.
4. Let it run for 40 seconds.

Soy milk

Ingredients for 1 litre of soy milk:

- 100 g yellow soy beans
- 1.4 litres water

Method

1. Wash 100 g of yellow soy beans in cold water, discard the water then cover in fresh cold water and leave them to soak for 18-24 hours.
2. After they have soaked for 24 hours, wash the soy beans, drain them and then blend them with 400 ml of water at speed **4** for 40 seconds, until you obtain a homogeneous paste.
3. Bring the remaining 1 litre of water almost to the boil in a pan.
4. Add the blended soy and cook, skimming off any foam which might form. Cook for 20 minutes from when it begins to boil.
5. Turn off the heat and leave to rest for 20 minutes.
6. After 20 minutes, strain the soy milk through clean muslin into a bottle.
7. You can sweeten and flavour the milk as you prefer, using vanilla, honey, malt extract or various syrups.



Recipes

Whipped cream

Ingredients:

- 500 g cold whipping cream
- 50 g icing sugar

Method

1. Whip the cream in the blender at speed **3** for approximately 30 seconds.
2. Stop the operation by pressing the **STOP** button.
3. Add the icing sugar.
4. Select speed **4** and whip for a further 15 seconds, until the cream is fully whipped.

Vegetable purée

Ingredients:

- 300 g courgettes
- 100 g water or vegetable stock

Method

1. Steam the courgettes and cut them into rounds.
2. Put the pieces in the blender and blend for 45 seconds at speed **4**, adding a little water or vegetable stock at a time until you obtain a homogeneous purée.

i

The cream can also be whipped without icing sugar.

In this case, select speed **4** and whip for 40 seconds.

Il costruttore si riserva di apportare senza preavviso tutte le modifiche che riterrà utili al miglioramento dei propri prodotti. Le illustrazioni e le descrizioni contenute in questo manuale non sono quindi impegnative ed hanno solo valore indicativo.

The manufacturer reserves the right to make any changes deemed useful for improvement of its products without prior notice. The illustrations and descriptions contained in this manual are therefore not binding and are merely indicative.

Le fabricant se réserve la faculté d'apporter, sans préavis, toutes les modifications qu'il jugera utiles pour l'amélioration de ses produits. Les illustrations et les descriptions figurant dans ce manuel ne sont pas contraignantes et n'ont qu'une valeur indicative.

Der Hersteller behält sich vor, ohne vorherige Benachrichtigung alle Änderungen vorzunehmen, die er zur Verbesserung seiner Produkte für nützlich erachtet. Die in diesem Handbuch enthaltenen Illustrationen und Beschreibungen sind daher unverbindlich und dienen nur zur Veranschaulichung.

De fabrikant behoudt zich het recht voor zonder waarschuwing alle wijzigingen aan te brengen die hij nodig acht om zijn producten te verbeteren. De afbeeldingen en de beschrijvingen die aanwezig zijn in deze handleiding zijn niet bindend, en hebben enkel een aanduidende waarde.

El fabricante se reserva el derecho a aportar sin aviso previo todas las modificaciones que considere útiles para la mejora de sus propios productos. Las ilustraciones y las descripciones contenidas en este manual no comprometen, por tanto, al fabricante y tienen un valor meramente indicativo.

O fabricante reserva-se o direito de efetuar, sem aviso prévio, qualquer modificação que vise o melhoramento dos respectivos produtos. As ilustrações e descrições contidas neste manual, não são, por isso, vinculativas e possuem apenas valor indicativo.

Tillverkaren förbehåller sig rätten att genomföra alla de ändringar som anses nödvändiga för att förbättra de egna produkterna utan att meddela detta i förväg. De illustrationer och beskrivningar som finns i denna bruksanvisning är vägledande och därmed inte bindande.

Производитель оставляет за собой право вносить без предупреждения все изменения, которые считает полезными для улучшения собственной продукции. Рисунки и описания, содержащиеся в данном Руководстве по эксплуатации, не имеют обязательств и имеют ознакомительный характер.

Producenten forbeholder sig retten til at foretage eventuelle ændringer, der anses for at være en forbedring af det oprindelige produkt, uden forudgående varsel. Illustrationer og beskrivelser i denne betjeningsvejledning er derfor ikke bindende og kun vejledende.

Producent zastrzega sobie prawo do nanoszenia, bez uprzedniego powiadomienia, wszelkich zmian, które uzna za przydatne w celu ulepszenia swoich produktów. Rysunki i opisy zawarte w niniejszej instrukcji nie są zobowiązujące i mają charakter poglądowy.

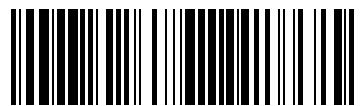

914776117/H