

IMPORTANT
 - Don't open the battery door under water.
 - Close the battery door properly for best water sealing.
 - Rinse the camera with clean water after used and keep it dry for storage.

1. Getting to know your camera

- 14.0 Mega pixels resolution sensor
- Digital still camera
- Digital video camcorder
- Built-in flash light
- 4x digital zoom
- 2.7+1.8" TFT color display
- MicroSD card support
- 2 x AAA alkaline batteries

2. Functional parts

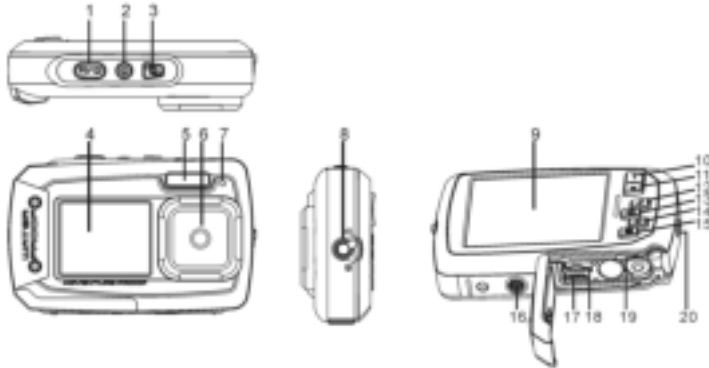

1	Shutter	Press this button to take photographs or to start /stop recording a video clip, or to confirm changes in menu mode
2	Power on/off button	Press this button for at least 2 seconds to switch on or off the camera. or press it to display or hide the status icon on LCD.
3	Monitor switching button	Press this button to switch between the front monitor and the back monitor.
4	Front monitor	Use the front monitor when taking self-portrait shots
5	Flash light	Use the built-in flash to give the subject extra lighting when shooting in the dark (the best shooting distance is within 1.5m).
6	Lens	Capture the image. Note: Keep the lens clean. Dirt and fingerprints will affect the quality of the picture.
7	Busy indicator	When the indicator is blinking, the camera is busy.
8	Macro/normal switch	Macro mode: Select this mode to take close-up photographs (distance 11cm - 18cm). Normal mode: Select this mode to take photographs from 0.5m - infinity.
9	Main screen	Display photographs, video clips, camera setting and menu.
10	Up/Tele	In Preview mode: press this button for zooming in. In Menu mode: press this button to move up the selection bar. In Image Playback mode: press this button for enlarging the photo. In Video Playback mode: press it to start/pause the video.
11	Down/Wide	In Shooting mode: press this button for zooming out. In Menu mode: press this button to move down the selection bar. In Image Playback mode: press this button for reducing the photo size. In Video Playback mode: press this button to enter the thumbnail mode
12	Left / Flash light	In Menu mode: press this button for the left selection; In Playback mode: press this button to go back to the previous one; In Photo Infinite Preview mode: press this button to switch to Flash mode; When zooming in under Image Playback mode: press it to move to the left portion of the photo. In Video Playback mode: press it for fast rewind.
13	Right / Playback	Press this button to enter Playback mode; In Playback mode: press this button to move to the next one; In Menu mode: press this button for the right selection; When zooming in under Image Playback mode: press it to move to the right portion of the photo. In Video Playback mode: press it for fast forward.
14	Mode switch	Press this button to switch between movie and still capture mode; In Playback mode: press this button to exit. When zooming in under Image Playback mode: press it to move to the upper portion of the photo. In Video Playback mode: press it to

		stop the video.
15	Menu / Delete	In Preview mode: press it to enter the settings Menu. In Playback mode: Press it for a short time to enter "Delete single/ all files" mode; Press it for a long time to enter file compiling and system setting menu. In Photo (zoom in) Playback mode: press it to move to the down area of the photo.
16	Tripod connector	For fixing the camera on the tripod.
17	USB interface	You can download photographs and video clips to a computer when connecting with a USB cable. (not included)
18	MicroSD card slot	MicroSD card storage location.
19	Battery compartment	Compartment for 2 x AAA alkaline batteries
20	Strap hook	Hook for attaching the wrist strap to the camera.

3. Explanation of the status icons

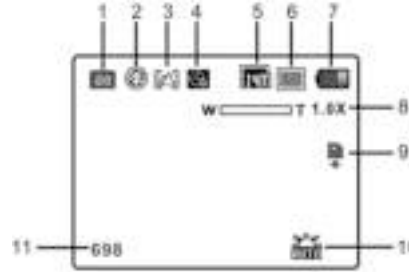

Item	Function	Description
1	Mode	Shows the current operating mode: Photo mode. Video mode.
2	Flash	Force flash: The flash will be on under any environment. Auto flash: The camera determines if the flash should be used or not. No flash: The flash is turned off.
3	Normal/Macro mode	Mode (0.5m – infinity). Macro mode (11cm – 18cm).
4	Self-timer	Indicates the Self-timer is set
5	Resolution	Shows the selected picture resolution: 20 M = 5184x3888; 14M = 4320x3240; 8M = 3264x2448; 5M = 2592x1944; 3M = 2048x1536; VGA = 640x480
6	Picture quality	Super fine. Fine. Normal
7	Battery indicator	The batteries are full. The batteries are empty.
8	Zoom indicator	Shows the zoom ratio during preview mode
9	MicroSD card	Indicates the MicroSD card is inserted and will be used as storage for PHOTO and VIDEO
10	White balance	Shows the selected White-balance mode.
11	Photo/Video counter	Photo mode: No. of pictures that can be taken. Video mode: Available recording time.

4. Details for camera settings

Category	Setting	Options	Description
Photo	Resolution	20 MP resolution	5184x3888
		14 MP resolution	4320x3240
		8 MP resolution	3264x2448
		5 MP resolution	2592x1944
		3 MP resolution	2048x1536
		VGA resolution	640x480
	Quality	Super Fine/Fine/Normal	Picture quality setting
	Metering	Center/Multi/Spot	Metering setting
	White Balance	Auto	Automatic white balance
		Daylight	White balance for shooting under fine weather condition
		Cloudy	White balance for shooting under cloudy condition
		Tungsten	White balance for shooting under tungsten lighting
	Fluorescent	White balance for shooting under fluorescent lighting	
ISO Speed	Auto/100/200/400/800	Sensitivity selection	
Exposure	±2.0, ±5/3, ±4/3, ±1.0, ±2/3, ±1/3, 0	Exposure setting	
Self Timer	On/Off	Self timer setting	
Sharpness	Hard/ Normal/ Soft	Sharpness setting	
Effect	Normal/ B&W/ Sepia/ Negative/ Lomo/ Pencil Sketch/ Red/ Green/ Blue/ Vivid	Effect setting	
Date Stamp	On/ Off	Date stamp setting	
Quick View	On/ Off	Quick view setting	
Video	Movie Size	VGA 640 x 480 QVGA 320 x 240	Video resolution setting
	White Balance	Auto	Automatic white balance
		Daylight	White balance for shooting under fine weather condition
		Cloudy	White balance for shooting under cloudy condition
		Tungsten	White balance for shooting under tungsten lighting
	Fluorescent	White balance selected for shooting under fluorescent lighting	
Setup	Sounds	Off/On	Sounds setting
	Frequency	50Hz / 60Hz	Select power frequency in your location
	Power Save	Off / 1Minute / 3 Minutes	Auto power off selection
	Language	English/ French/ Deutsch/Italian/Spanish/ Portuguese/Japanese	Display language selection
	Date/Time	YY/MM/DD/HH/MM/SS	Date or time setting
Format	Yes/No	Format the MicroSD Card	
Reset All	Yes/No	Reset all settings to factory default positions	
Version	Shows the firmware version		

Note: Turning off the camera will not erase the last settings.

5. Using the camera

5.1 Installing the batteries

1. Open the battery door.
2. Insert 2 x AAA alkaline batteries into the camera compartment.
3. Close the battery door.



Note:

Make sure that the batteries are inserted in the right directions (as marked in the diagram above).

5.2 Inserting a memory card (not included)

This camera has no built-in internal memory. The memory can be gained with a MicroSD memory card (not included).

Follow the instructions below to insert the optional MicroSD memory card into the camera.



1. Turn off the camera first.
2. Open the battery door (please make sure the battery door was unlocked before open).
3. Insert the MicroSD card into the camera.



Notes:



1. There is only one right direction to insert the MicroSD memory card into the slot. Do not force the card into the memory card-slot, which may damage both the camera and the MicroSD memory card.
2. The MicroSD memory card must be formatted before taking photographs. See the following section for more information.

5.3 Formatting the memory or microSD card



1. Press the Menu button () in PHOTO or VIDEO mode.
2. Select the setup mode by pressing the Right button.
3. Select the format icon by pressing the **W** () button and press the Shutter button to confirm.
4. Press the Shutter button to format the SD memory card.

5.4 Setting the resolution

The camera can be set to different resolutions.

1. Press the Menu button () in PHOTO mode, select the resolutions icon by the **W** () button and press the Shutter to confirm.
Available resolutions:
VGA (640 x 480), 3M (2048 x 1536),
5M(2592x1944); 8M(3264x2448); 14M=4320x3240; 20M=5184X3888.
2. Six different resolutions will be displayed. Select the desired resolution by using the Up or Down button and press the Shutter button to confirm the selection.

5.5 Taking photos

1. Turn on the camera.
2. Depending on the distance to the object being photographed, use macro switch to adjust the distance.
Set the macro switch to macro mode () if you wish to take a close-up photograph. (11cm–18cm);
Set the macro switch to normal mode () if you wish to take a video or a photo of surroundings or people (0.5m – infinity).
3. If you are not sure if there is enough lighting, turn on the automatic flash () by pressing the Flash button. (If the battery power is too low, the flash won't be activated).
4. Use the LCD screen to aim at the object you wish to take photographs of.
5. Press the Shutter button and wait until the LCD display turns on again.

Cautions:

- 1) Taking pictures for fast-moving object is not recommended.
- 2) Image may be distorted when taking pictures in a moving vehicle.

5.6 Zooming in and out

The camera can zoom in up to 4 times.

Zoom in or out by pressing the Up or Down button, a number will appear on the display, 4.x is the maximum zoom ratio.



5.7 Taking a self-portrait shot using the front monitor

If you want to take a photo of yourself, you can simply use the front LCD screen. Follow the steps below:

1. Press the Monitor switching button to switch to the front monitor.
2. Use the front monitor as a viewfinder to aim at yourself.
3. Press the Shutter button to take a photo of yourself.



5.8 Self-timer setting

You can also use the self-timer function when you take a photograph of yourself or when you take a photograph without flash of an object. To avoid shaking of the camera a tripod is recommended.





1. Set the camera to photo mode.
2. Press the Menu button (). The menu will appear.
3. Press the **W** () button to select Self Timer and confirm by pressing the Shutter button.
4. Press the **W** () button to select the "On" option
5. Press the Shutter button to confirm. The self-timer function is now ready for use.
6. Aim at the object you wish to take photos of.
7. Press the Shutter button to take a photograph.

8. The photo will be taken after the timer reaches the delay time of 10 seconds. The camera will beep during the delay time.

5.9 Recording video clips

1. Press the Mode button to select the video clip mode ().
2. For setting the resolution, press the Menu () button and select Resolution, then press the Shutter button to confirm. Two resolutions will be displayed.
VGA (640 x 480), QVGA (320 x 240).
3. Press the Shutter button to start recording videos, press the right button to pause and press the Shutter button again to stop recording. The video clip will now be saved as an AVI file in the MicroSD memory card.
After reaching a max. video recording time of 29 minutes the camera will automatically stop. It can only be restarted manually.



5.10 Playing back photos

1. Press the Playback () button to enter the Playback mode.
2. The last picture or video clip taken will be displayed. Press the **W** () to enter the thumbnail mode. Press the Left /Right /Up/Down button to select the desired picture, and press the Shutter button to view.
3. In full screen display, press the **T** () button to zoom in the photo.
4. To shift the image in zoom-in mode, press the Shutter button and then use the Mode/Menu/Left/Right buttons.
5. Long press the Menu () button in Playback mode until the menu is displayed. Select Slide Show and set up the desired slide show way. Press the Shutter button to confirm. The pictures saved in the MicroSD card will be displayed in sequence automatically. To stop slide show, press the Shutter button.
6. Long press the Menu () button in Playback mode until the menu is displayed. Select Photo Effect and press the Shutter button. Select the desired effect by pressing the up/down button and press the shutter button to confirm. The image will be saved as a separate image.

5.11 Protecting photos/videos

To lock up the photos/videos and make them under protection from being deleted by the camera, follow the instructions below.



Follow the instructions below to protect photographs/videos.

1. Press the Playback () button to get into Photo playback mode.
2. Press the Left or Right button to select the photograph/video clip to be protected.
3. Long press the Menu () button in Playback mode until the menu is displayed. Select Protect and press the Shutter button.
4. Select "Single" or "Protect all" and press the Shutter button to confirm to set a single file or all the files under protection.
5. To unprotect the protected file(s), please select "Unprotect all".

5.12 Resizing photos

A captured image can be resized and saved as a separate image.

Follow the instructions below to resize photographs.

1. Press the Playback () button to get into Photo playback mode.
2. Press the Left or Right button to select the photograph/video clip to be resized.
3. Long press the Menu () button in Playback mode until the menu is displayed. Select Resize and press the Shutter button.
4. Select the new size and press the Shutter button to confirm. The image will be saved as a separate image.



5.13 Playing back video clips

1. Press the Playback () button to enter the playback mode.
2. Press the Left or Right button to select the video.
3. Press the Up button to play the video.
4. When the video is being playing, press the Up button to pause or resume.
5. Press the Right button for fast forward or press the Left button for fast rewind.
6. Press the Mode button to stop and exit.

5.14 Deleting photos and video clips

You can delete a single photograph / video clip, or delete all the photographs / video clips in the memory card.

Follow the instructions below to delete photographs/videos.

1. Press the Playback () button to enter the playback mode.
2. Press the Left or Right button to select the photograph/video clip to be deleted.
3. Press the Menu/Delete button () and select "Single" or "All" .
4. Press the Shutter button to confirm.
5. Press the Menu button to exit.

Note:

Select "All" and press the Shutter button to confirm, all the pictures and videos will be deleted. Photos that are protected from accidental erasure cannot be deleted. To delete photos, set the protect setting for the set photos to unprotect mode (Section 5.11), you can then delete the photos by following the above 1- 5 procedures.

6. Connecting to a PC

The unit can be connected to the computer as mass storage device and transfer photo/video files for storage.

7. Specifications

Sensor	14.0 Mega pixels CMOS sensor
Image resolution	20 Mega pixels: (5184x3888)
	14 Mega pixels: (4320x3240)
	8.0 Mega pixels: (3264x2448)
	5.0 Mega pixels: (2592x1944)
	3.0 Mega pixels: (2048x1536) VGA: (640x480)
Lens	F/2.8 f = 8.5mm
Focus range	0.5m. ~ Infinity
Macro mode	11cm – 18cm
Digital zoom	4x
Flash strobe	Built-in (Auto / force / off)
M-Shutter	Yes
LCD display	2.7+1.8" TFT color display
White balance	Auto / Daylight / Cloudy / Fluorescent / Tungsten
Video Frame Rate	30fps@VGA / 30fps@QVGA
External Storage Media	MicroSD card, not included (supports up to 32GB)
File format	Picture: JPEG, Video: AVI
Self timer	10 seconds
PC interface	USB 2.0
Power source	2 x AAA alkaline batteries

8. System requirements

Operating system	Win XP, Vista, Win7, Win8, Win10, Mac OSX 10.6.8 or above
CPU	Pentium III or above
RAM	At least 64MB
Interface	USB port
CD	4x speed CD ROM or above

9. Troubleshooting

Problem	Cause	Solution
Cannot turn on the camera	Low battery power. Batteries placed at wrong polarities.	Replace or install the batteries correctly.
Photos can not be saved when taking pictures.	The memory card hasn't been formatted properly.	Format the memory card in setup mode of the camera. Please refer to section 5.3.
Cannot find removable disk after connecting the camera to the computer.	Connection failure.	Make sure all cable connections are secured and restart the computer if necessary.
Flash does not work.	Battery power is too low.	Replace with new 2x AAA alkaline batteries
Batteries used up very fast.	Old, used up battery	Replace with new 2 x AAA alkaline batteries
Blurry photos	1. The camera is not held steadily 2. The lens of camera is dirty.	1. Hold the camera steadily until it beeps when taking a photo. 2. Clean the lens with soft and dry cloth.

Before using your camera in the water please verify that all lids and locks are tightly closed and sealed.

After using the camera in water please let it dry.

The camera should not be exposed to high temperatures and humidity differences to avoid condensation behind the lens.

Open the battery compartment only when the camera is dry.

HOW TO OPEN THE BATTERY COMPARTMENT OF THE CAMERA

Push the release lever toward the rear of the camera.

At the same time place your fingernail under the cover in the middle of the camera and slide the compartment to the outside.

The battery compartment cover can now be hinged upward.

DECLARATION OF CONFORMITY

easypix hereby declares that the product W1400 is in conformity to all the

essential requirements of Directive 1999/5/EC. The declaration of conformity can be downloaded here:

http://www.easypix.info/download/pdf/doc_w1400.pdf

For technical support please visit www.easypix.eu.



Only EU

easypix[®]
LIFESTYLE ELECTRONICS