

K'nex

IMAGINE™

BUILDER BASICS Building Set

ÉLÉMENTS ESSENTIELS DE CONSTRUCTION

Jeu de construction

35

BUILDS
MODÈLES*

Ages
7-12

17010

⚠ WARNING:
CHOKING HAZARD – Small parts.
Not for children under 3 years.

⚠ ATTENTION :
RISQUE D'ÉTOUFFEMENT – Pièces de petite taille.
Ne convient pas aux enfants de moins de 3 ans.

* Modelos
Modelle
Modelli
Modelo
Modellen



(EN) CONTENTS

TIC-TAC-TOE	3
TRUCK	4
TRUMPET	5
CRAB	5
SHUTTLE	6
OWL.....	7
GIRAFFE, FENCE & TREE.....	8
MONKEY & GYM	10
MOTORCYCLE.....	12
DRAGSTER	14
SWING RIDE	16
BUILDING IDEAS.....	20

(FR) CONTENU

TIC-TAC-TOE	3
CAMION	4
TROMPETTE.....	5
CRABE	5
NAVETTE	6
CHOUETTE.....	7
GIRAFE, CLÔTURE ET ARBRE	8
PETIT SINGE & GYM	10
MOTORCYCLETTE	12
DRAGSTER	14
TOUR DE BALANÇOIRE	16
IDÉES DE CONSTRUCTION	20

K'nex

Building Basics Bases de Construction

Start Building

Each K'NEX piece has its own shape and color. Try to position your model in the same direction as the instructions. Faded colors show you this section is already built.

Démarre ta Construction

Chaque K'NEX pièce a sa propre forme et sa propre couleur. Pour te faciliter la tâche, oriente le modèle dans le même sens que les instructions. Les pièces ayant une couleur estompée sont celles déjà assemblées.

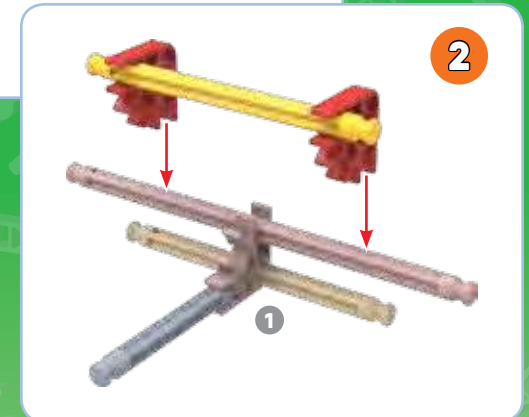
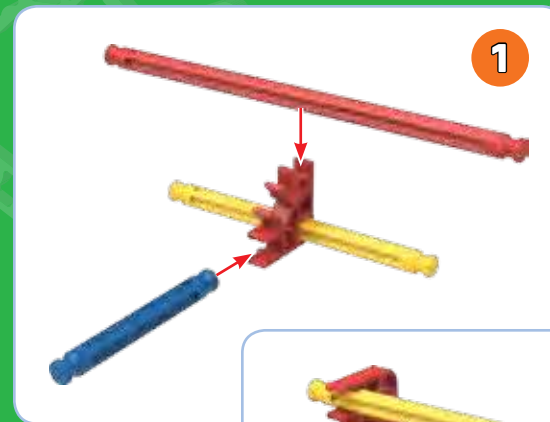

Connectors

Push these special connectors together tightly until you hear a "click".

Connecteurs

Pousse connecteurs spéciaux fort jusqu'à entendre un « clic ».

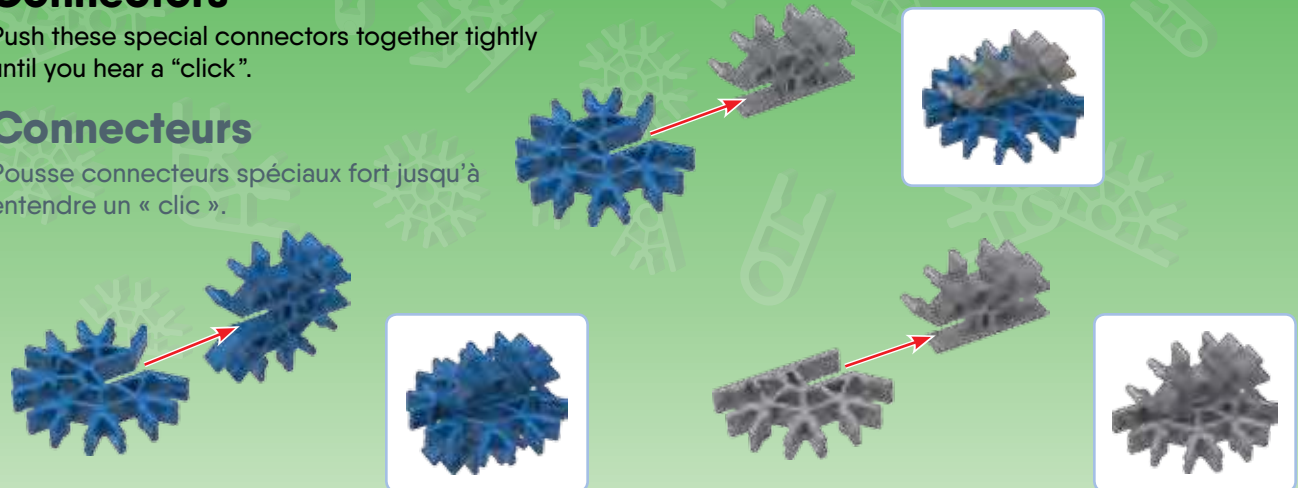

Spacers

Be sure to use the correct color and number of spacers shown.

Séparateurs

Assure-toi d'utiliser la bonne nombre de séparateurs.



Parts List

Be sure to compare the parts in your set with the parts list here. If anything is missing, call or write to us using the information on the back cover.
We are here to help you!

Liste des Pièces

Assure-toi de comparer les pièces dans ta boîte à la listede pièces fournie ici.
S'il manque quelque chose, téléphone-nous ou écris-nous en te servant des informations figurant au verso de la notice. Nous sommes là pour t'aider !

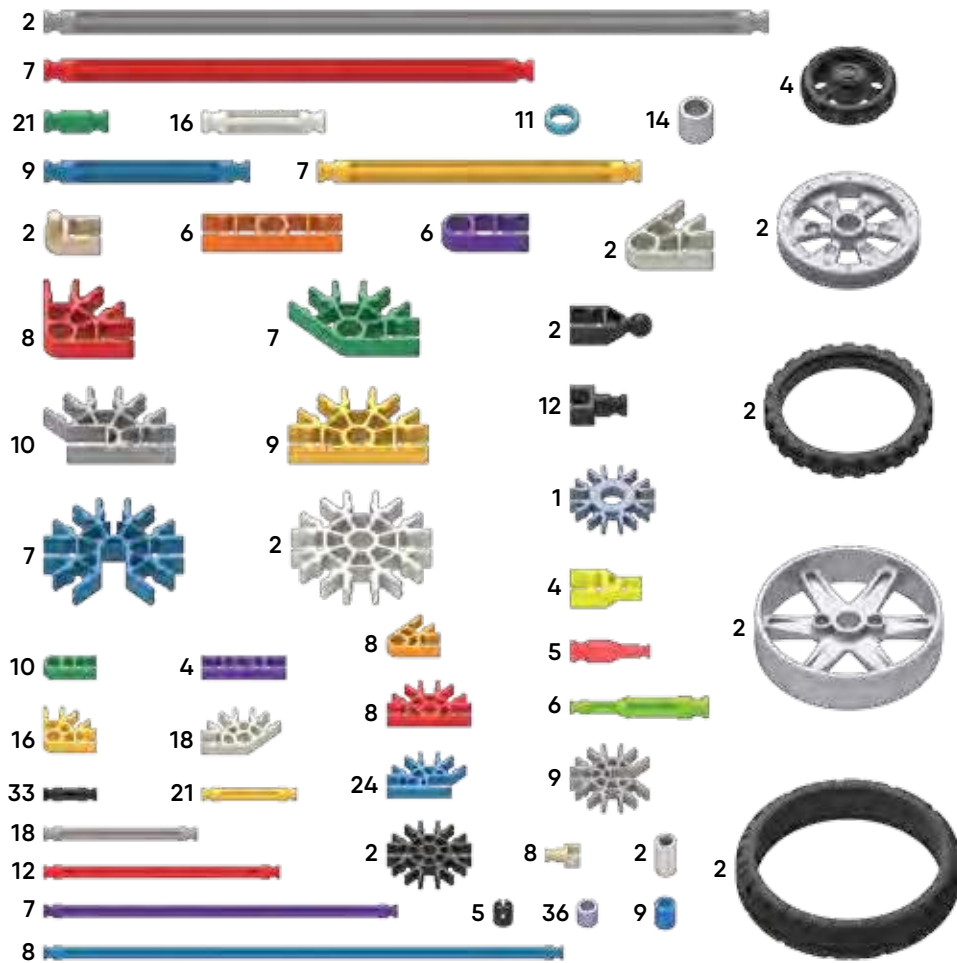

WARNING: CHOKING HAZARD – Small parts. Not for children under 3 years.

ATTENTION : RISQUE D'ÉTOUFFEMENT – Pièces de petite taille. Ne convient pas aux enfants de moins de 3 ans.

ADVERTENCIA: PELIGRO DE ASFIXIA – Piezas pequeñas. No para niños menores de 3 años.

ACHTUNG: ERSTICKUNGSGEFAHR – Kleinteile. Nicht geeignet für Kinder unter 3 Jahren.

AVVISO: PERICOLO DI SOFFOCARE – Pezzi piccoli. Non adatto per bambini sotto 3 anni.

AVISO: PERIGO DE SUFOCAÇÃO – Peças pequenas. Não se destina a crianças com menos de 3 anos de idade.

WAARSCHUWING: INSLIKKINGSGEVAAR – Kleine onderdelen. Niet geschikt voor kinderen jonger dan 3 jaar.

CAUTION: Keep hands, face, hair and clothing away from all moving parts.

ATTENTION : Garde les cheveux, les doigts, la figure et les vêtements à l'écart de toutes les pièces mobiles.

PRECAUCIÓN: Mantén el cabello, los dedos, la cara y la ropa alejada de las piezas móviles.

VORSICHT: Haare, Finger, Gesicht und Kleidungsstücke nicht mit beweglichen Teilen in Berührung kommen lassen.

ATTENZIONE: Tenere i capelli, le dita, il viso e i vestiti lontano da tutte le parti in movimento.

CUIDADO: Mantém o cabelo, os dedos, a cara e a roupa afastados de todas as peças móveis.

LET OP: Hou het haar, de vingers, het gezicht en kledij verwijderd van alle bewegende onderdelen.

TIC-TAC-TOE TIC-TAC-TOE

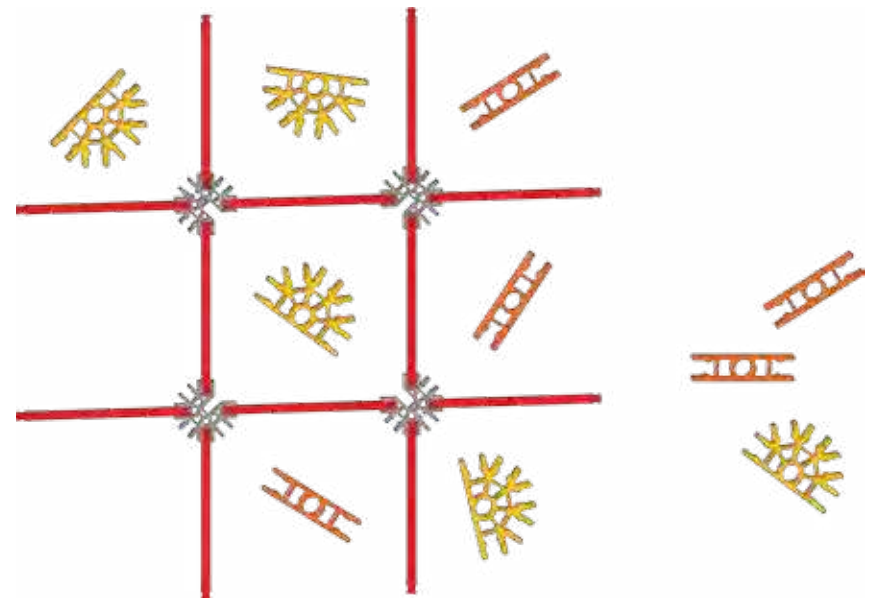
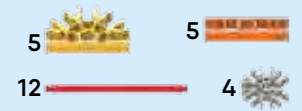

TRUCK CAMION

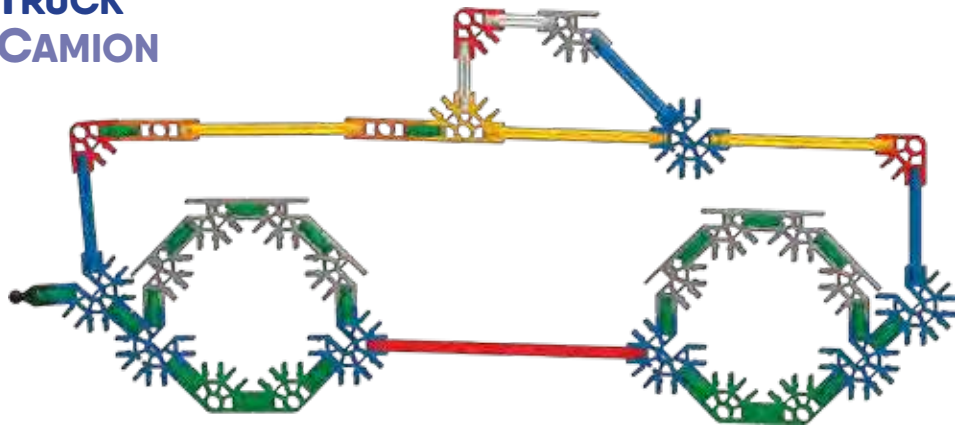

x2

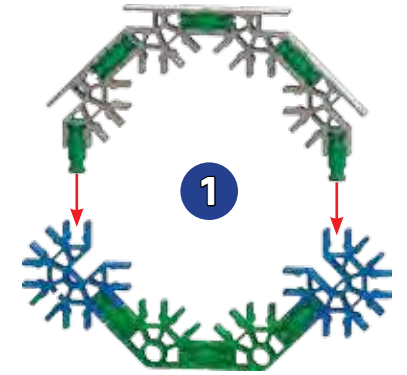

x2

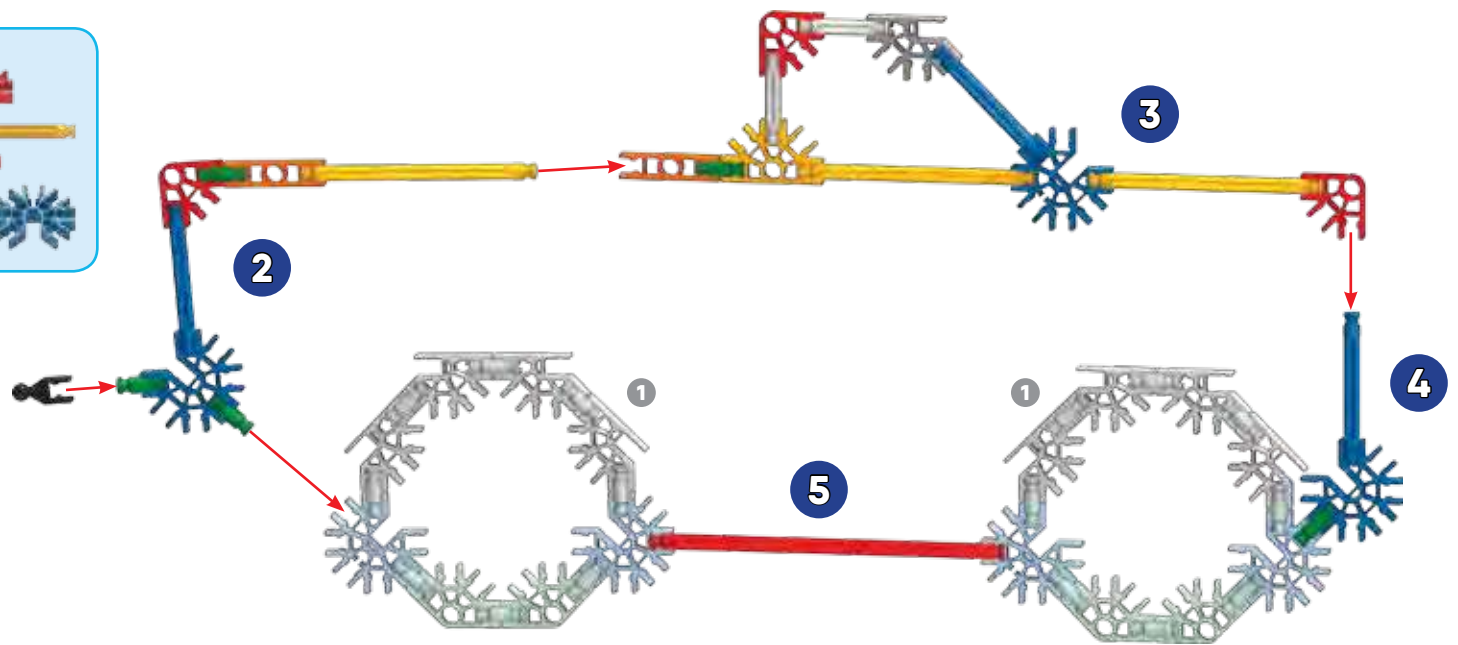
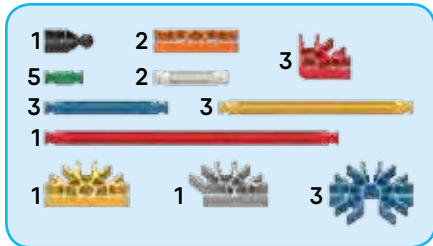
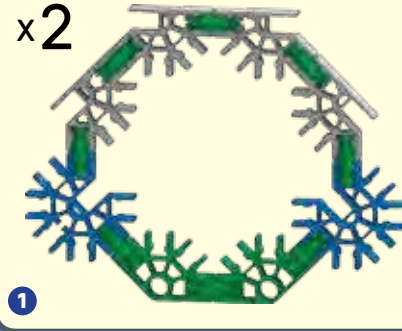

TRUMPET TROMPETTE

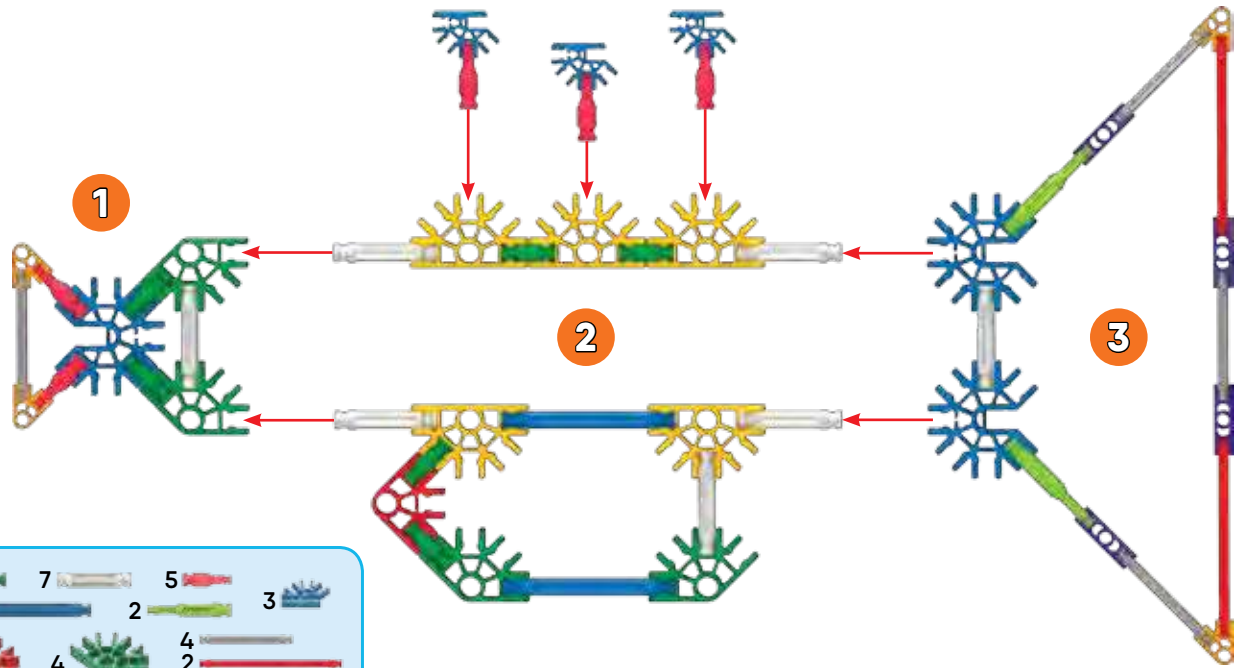
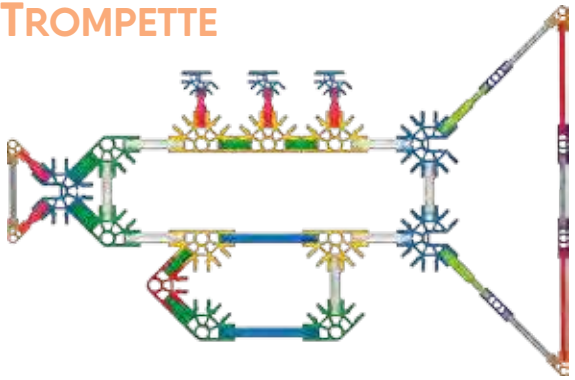

- | | | | |
|---|---|---|---|
| 6 | 7 | 5 | 3 |
| 2 | 2 | 2 | 4 |
| 1 | 4 | 4 | 2 |
| 3 | 5 | 4 | 4 |

CRAB

CRABE

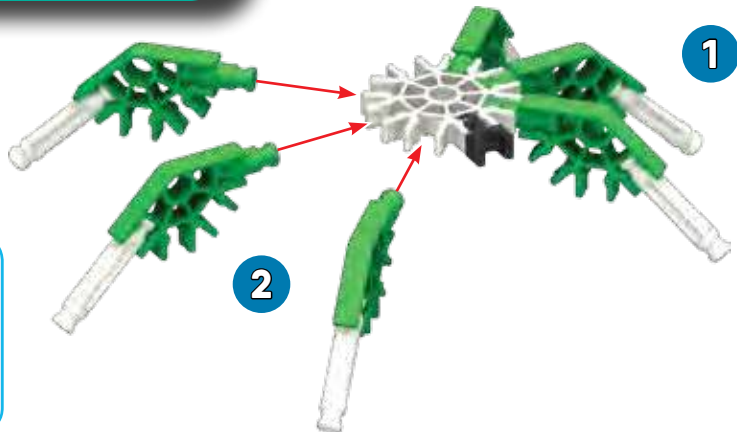

- | | |
|---|---|
| 6 | 6 |
| 1 | 6 |
| 1 | |

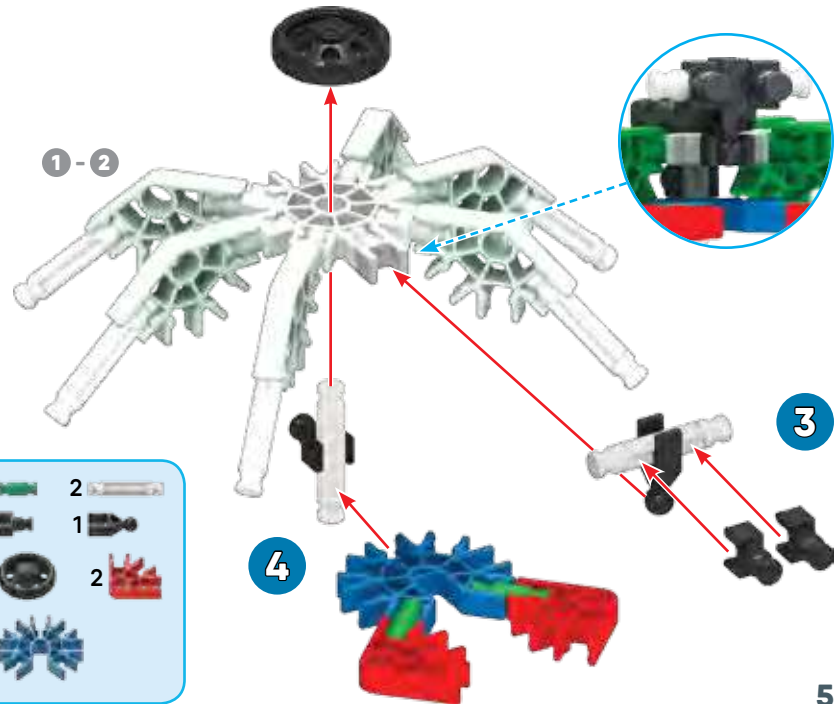

- | | |
|---|---|
| 2 | 2 |
| 3 | 1 |
| 1 | 2 |
| 1 | |

SHUTTLE NAVETTE

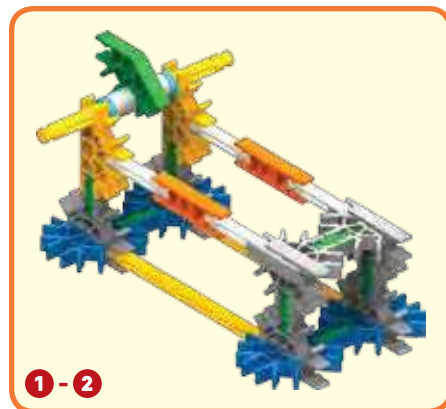
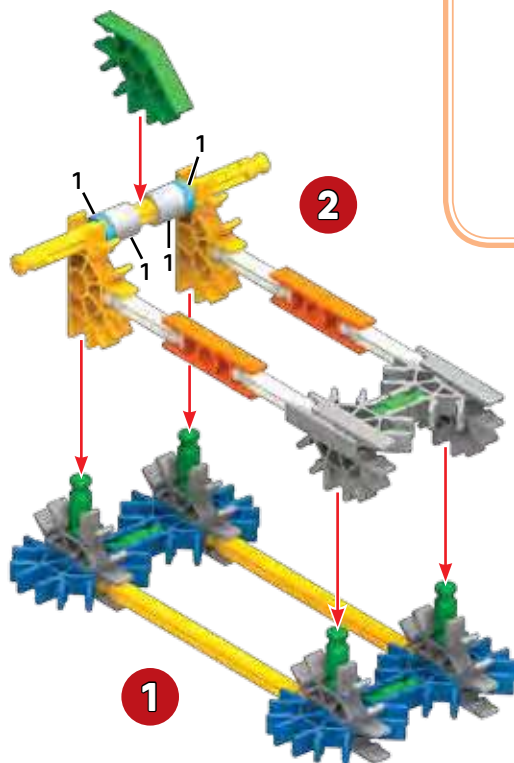
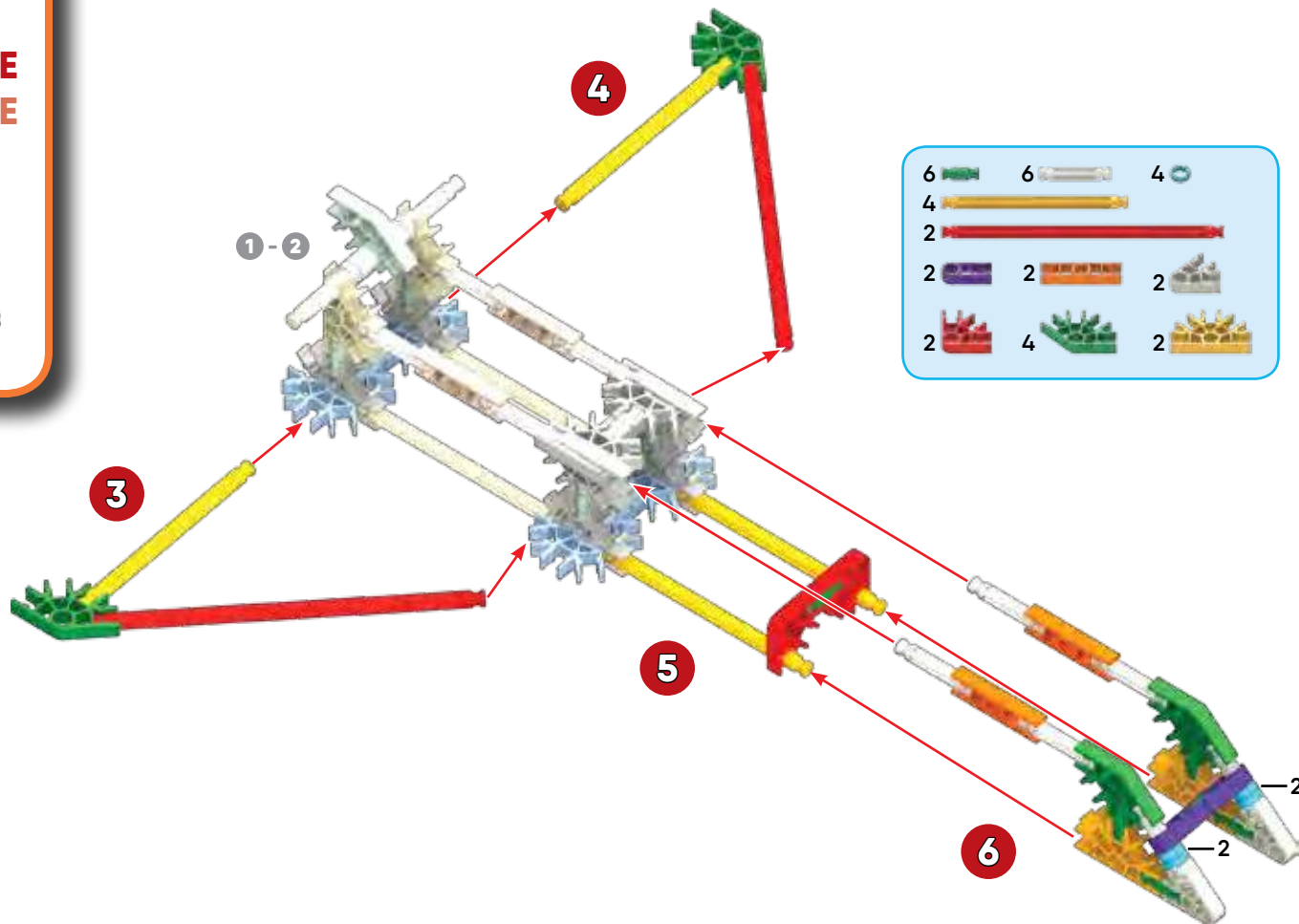

OWL CHOUETTE

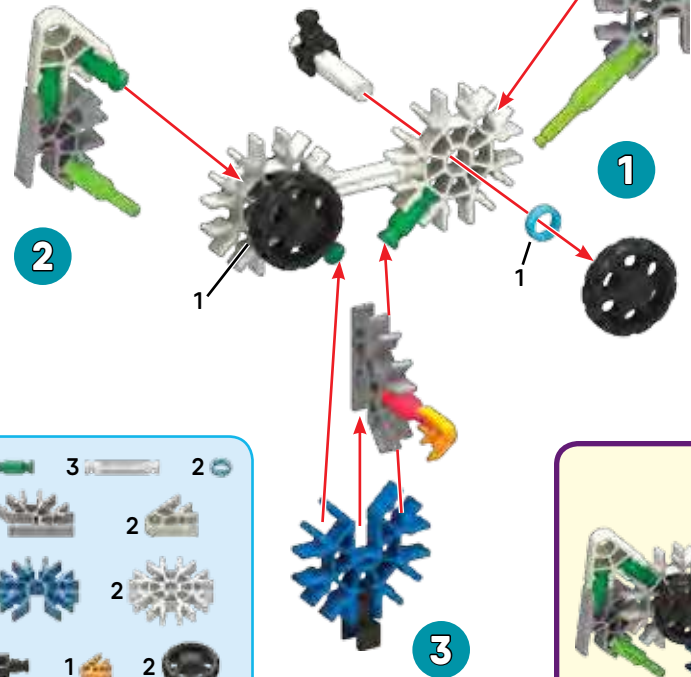

- 6
- 3
- 2
- 3
- 2
- 1
- 2
- 3
- 1
- 2
- 1
- 2



1-3

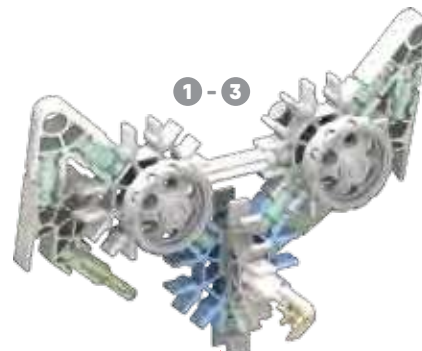

1-3

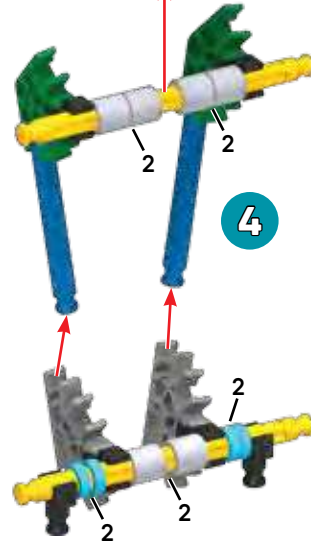

4

5

- 4
- 6
- 6
- 2
- 2
- 2
- 2



1-5

- 1
- 4
- 2
- 4
- 4

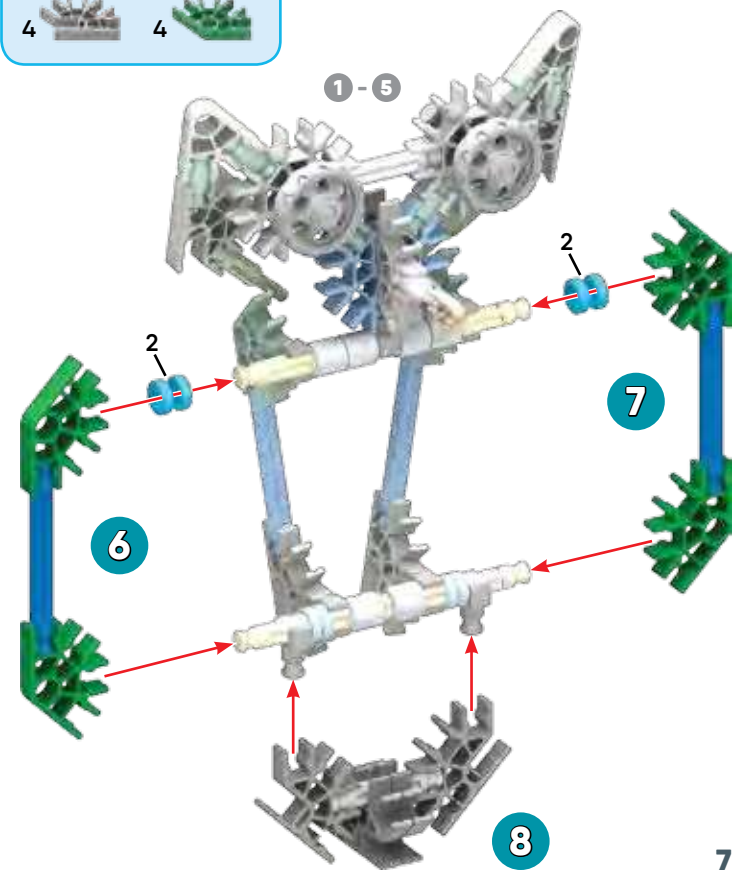

1-5

6

7

8

GIRAFFE, FENCE & TREE
GIRAFE, CLÔTURE ET ARBRE



- 8
- 2
- 1
- 2
- 4
- 1
- 1
- 8

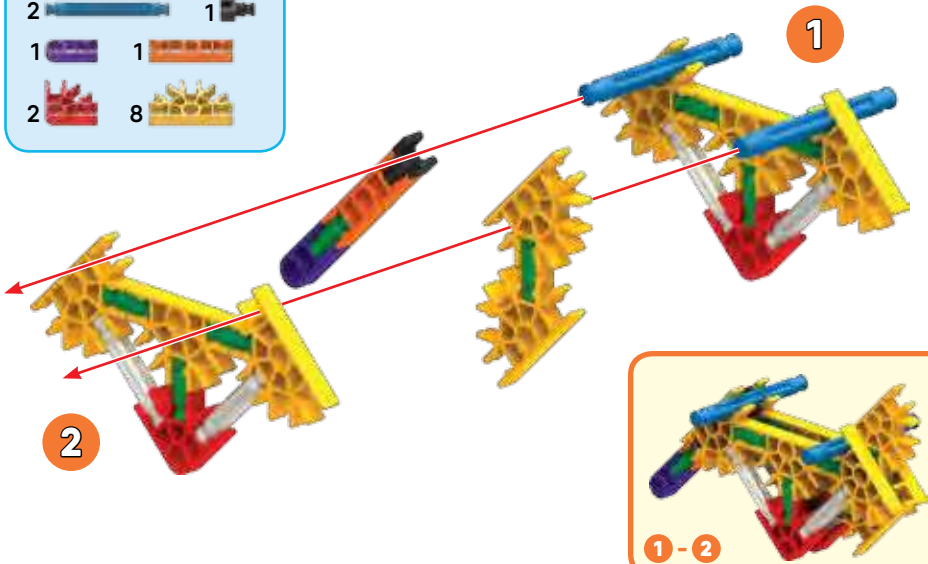

- 2
- 6
- 1
- 2
- 1
- 2
- 1

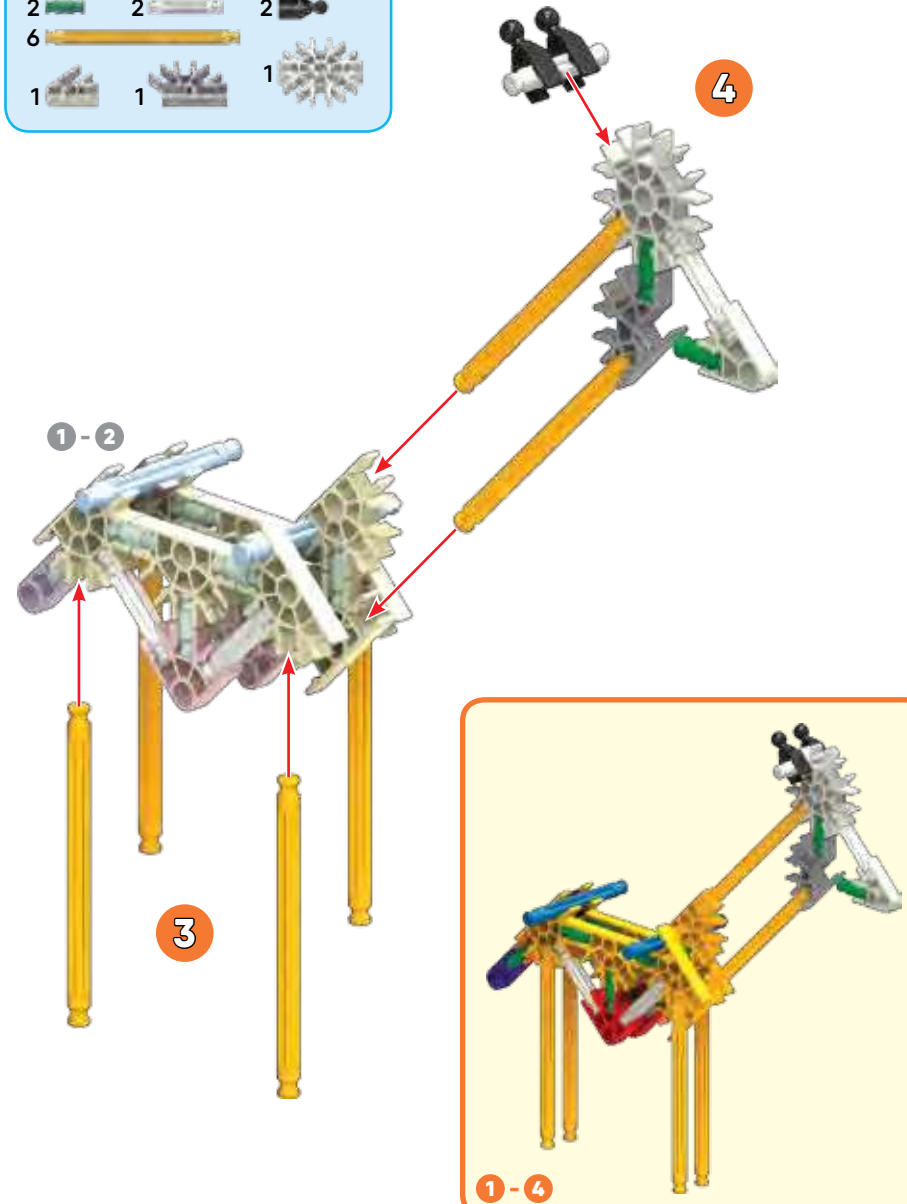

- 3
- 4
- 2
- 1
- 3
- 3

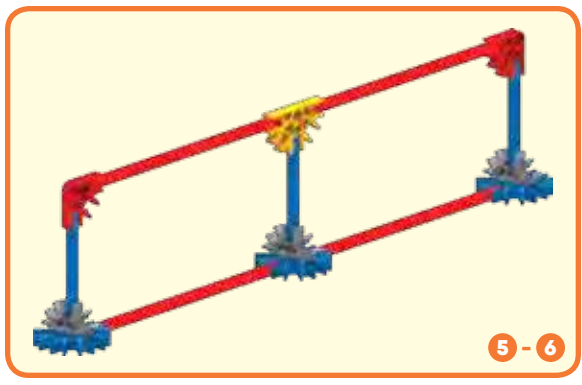
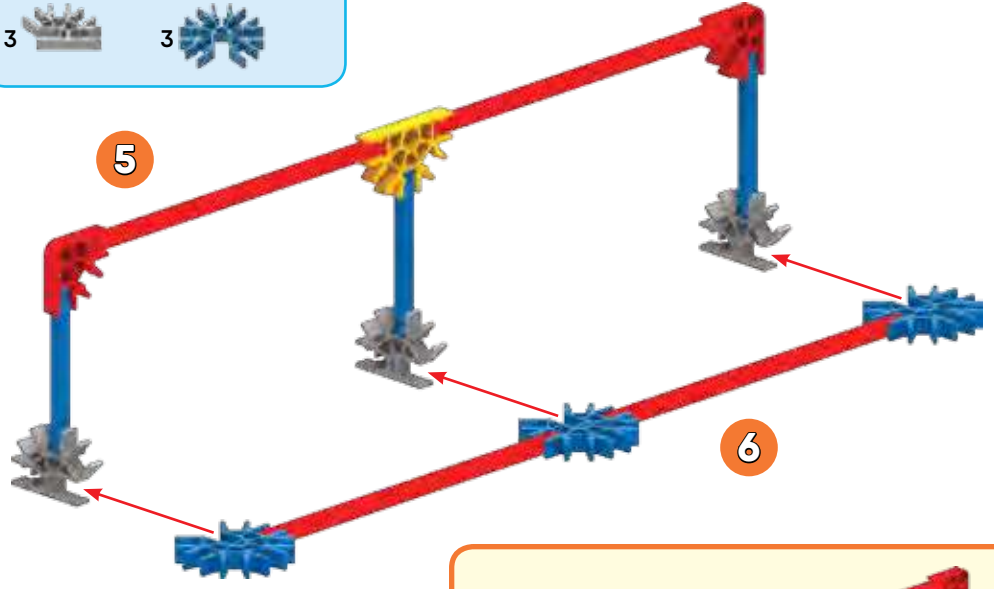

- 8
- 4
- 6
- 1
- 1
- 3

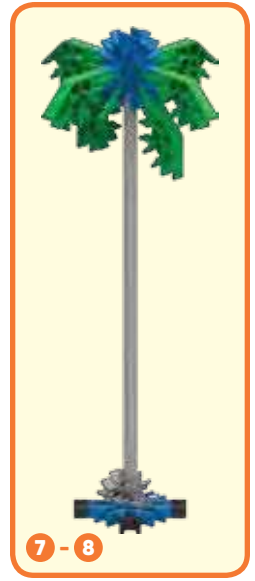

MONKEY & GYM PETIT SINGE & GYM

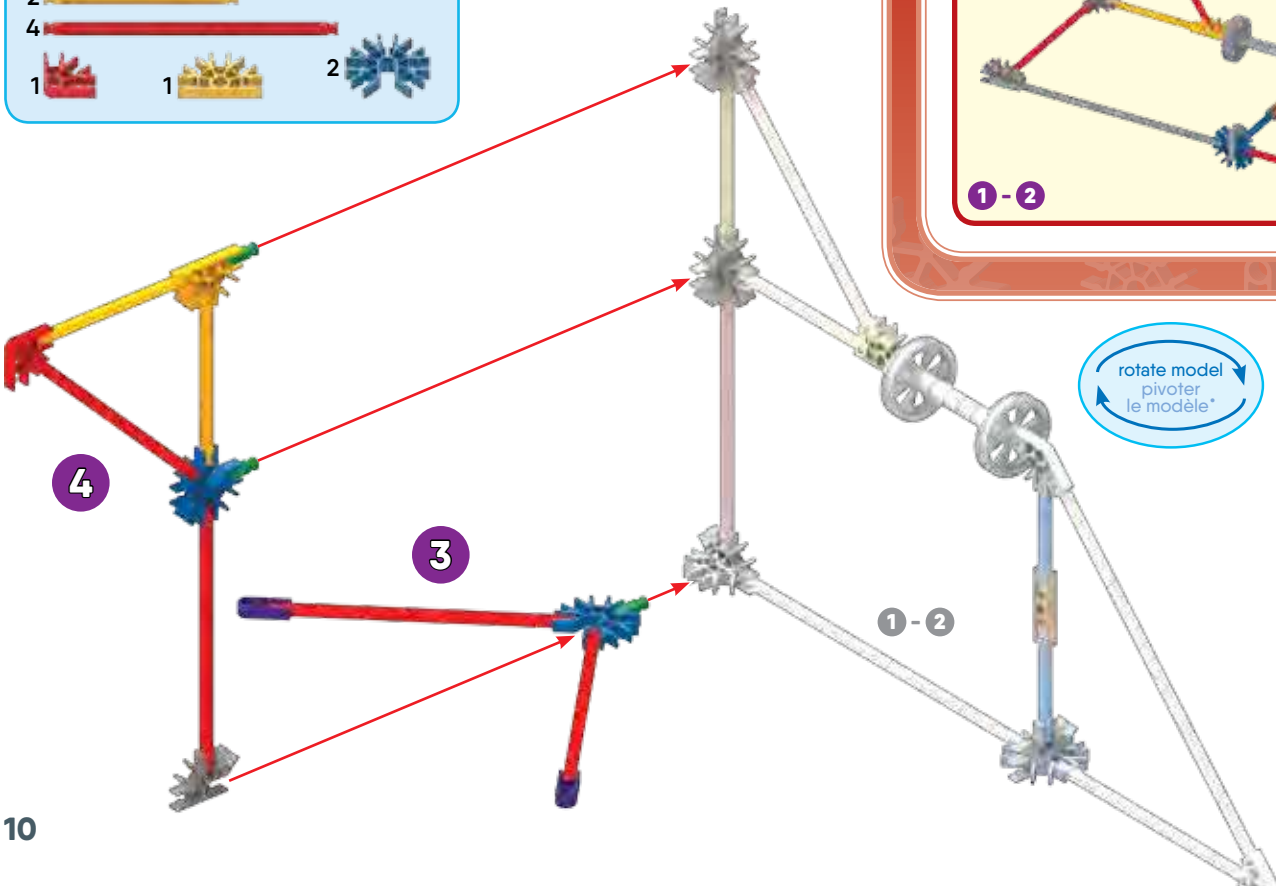
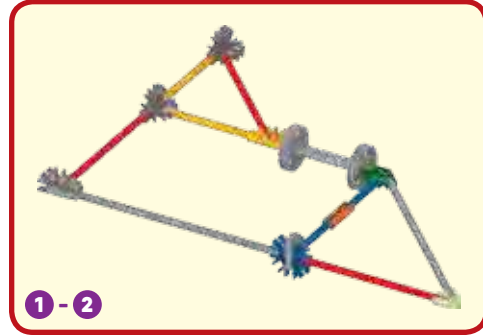
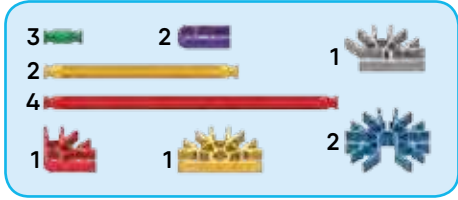
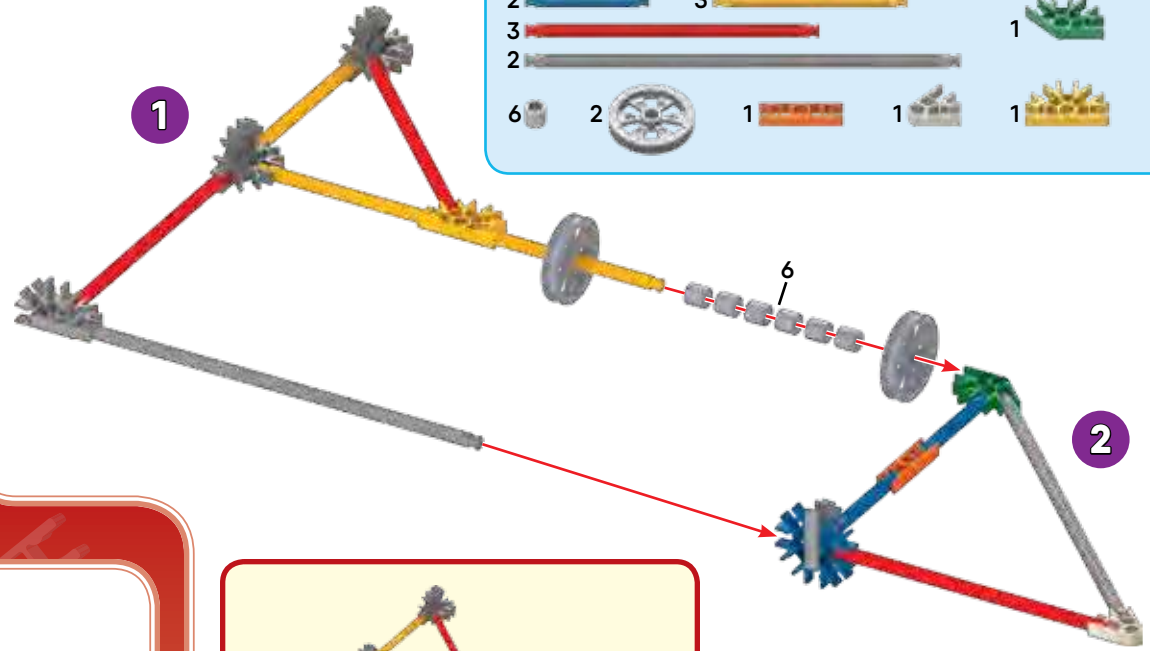

rotate model
pivoter le modèle*

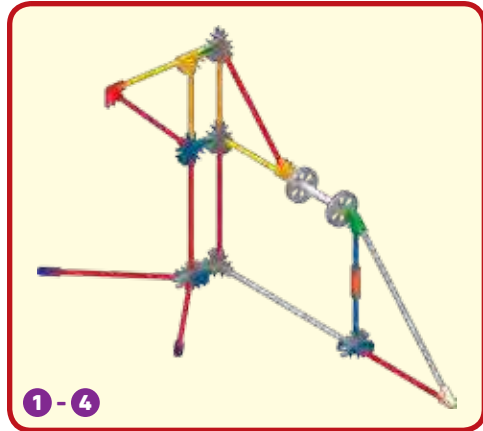

* (ES) gire modelo (PT) gire modelo
(DE) drehe das modell (NL) draai model
(IT) gira il modello

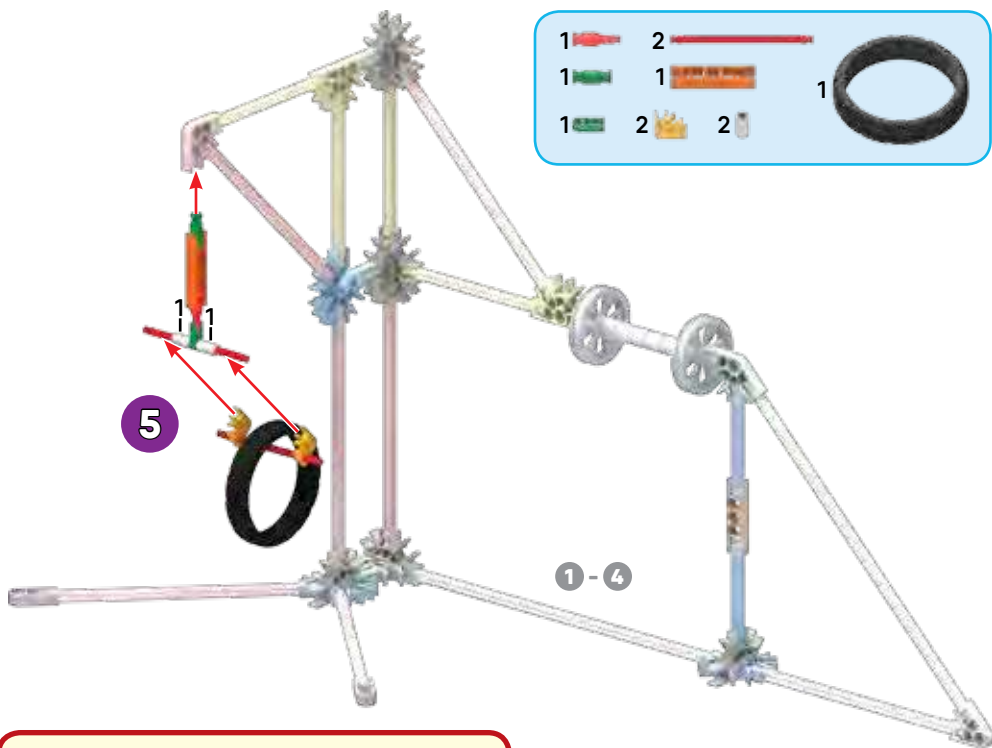

- | | | |
|---|---|---|
| 1 | 2 | |
| 1 | 1 | 1 |
| 1 | 2 | 2 |

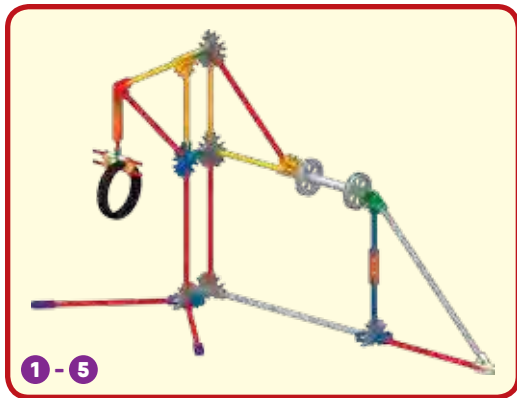

1-5

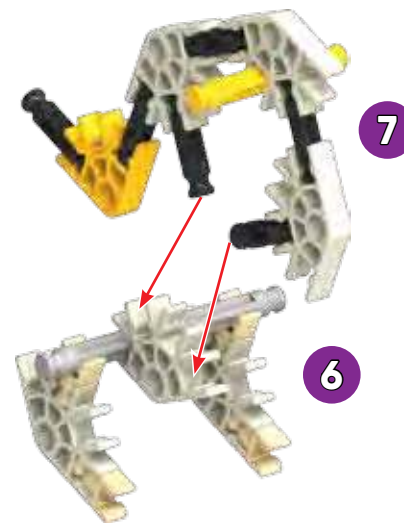

- | | |
|---|---|
| 1 | 6 |
| 6 | 1 |
| 1 | 4 |



6-7

- | | | |
|---|---|---|
| 2 | 4 | 2 |
| 3 | 5 | 1 |

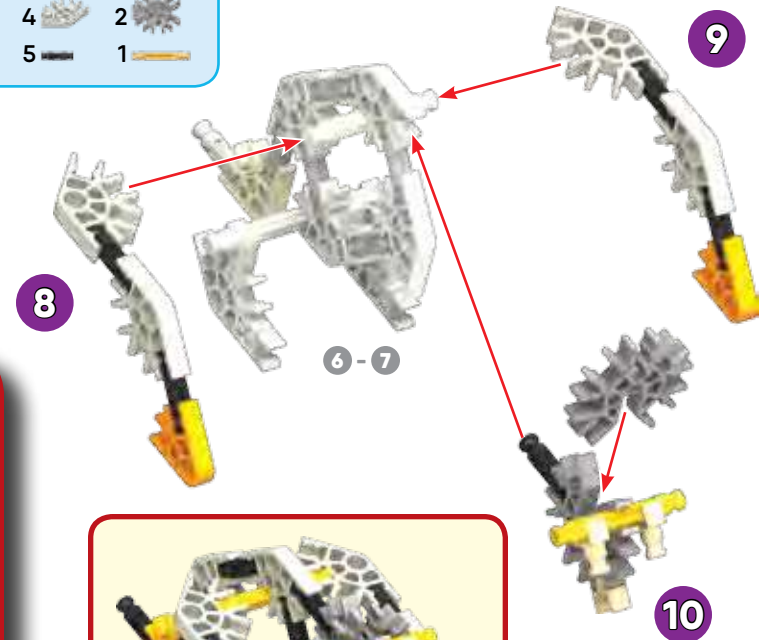

8

6-7

9



**MONKEY & GYM
PETIT SINGE
& GYM**



6-10

MOTORCYCLE MOTORCYCLETTE



- | | | | | |
|---|---|---|---|---|
| 3 | 2 | 2 | 2 | 2 |
| 4 | 2 | 2 | 2 | 2 |
| 3 | | | | |
| 4 | 2 | | | |

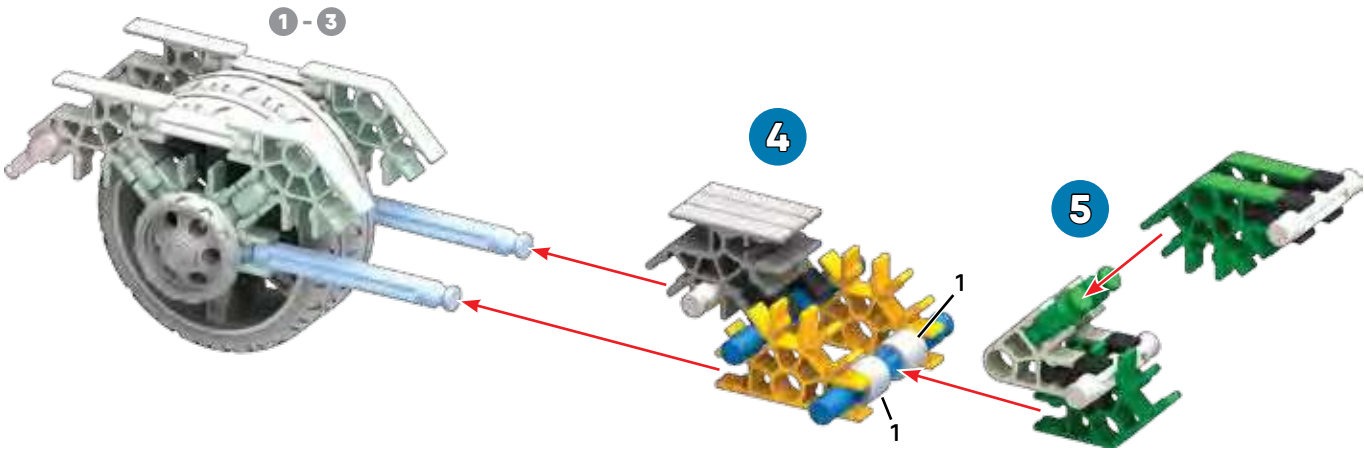
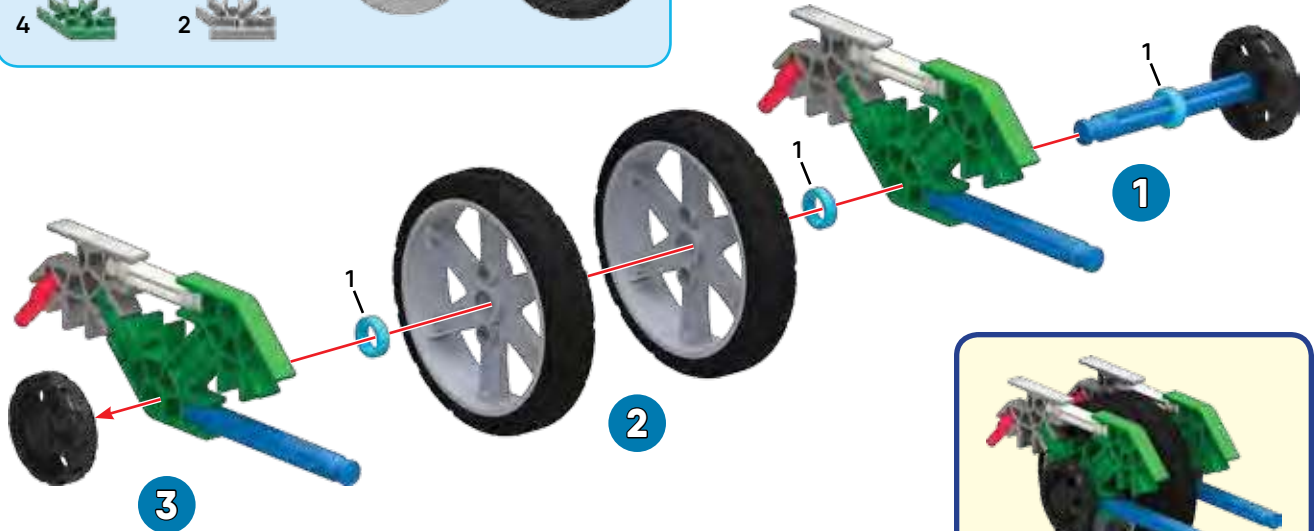

- | | | | |
|---|---|---|---|
| 2 | 3 | 6 | 2 |
| 2 | | | |
| 2 | 3 | 2 | 3 |



- | | | | |
|---|---|---|----|
| 1 | 2 | 8 | 12 |
| 1 | 2 | 2 | |
| 2 | 1 | 1 | 1 |

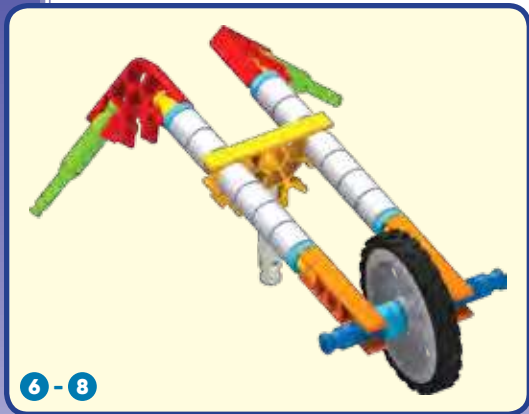
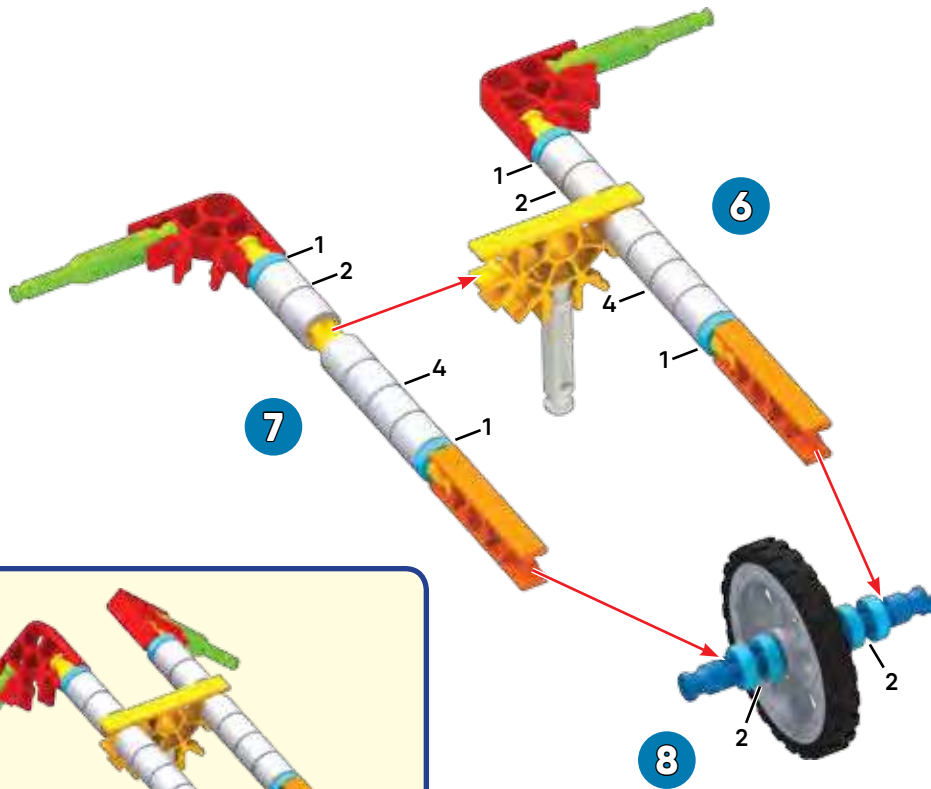

**MOTORCYCLE
MOTORCYCLETTE**

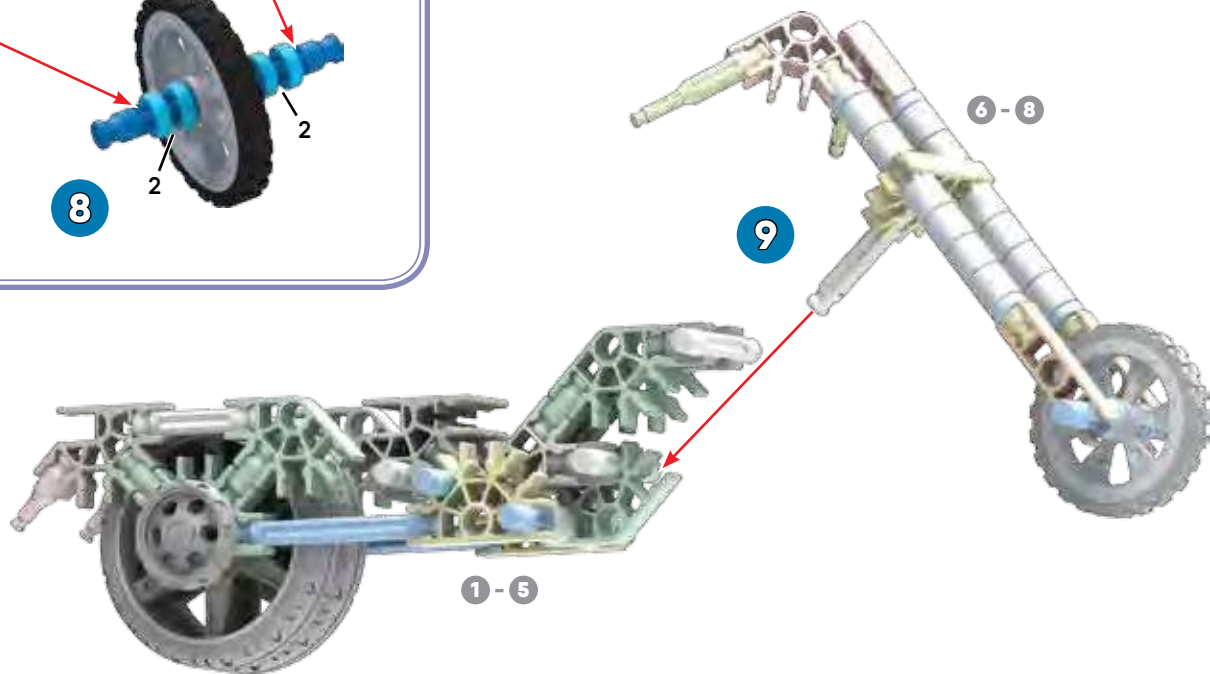

DRAGSTER & STAGING LIGHTS

DRAGSTER & ÉCLAIRAGE DE SCÈNE



- | | | |
|---|---|---|
| 4 | 2 | |
| 4 | 4 | 2 |
| 2 | 4 | |

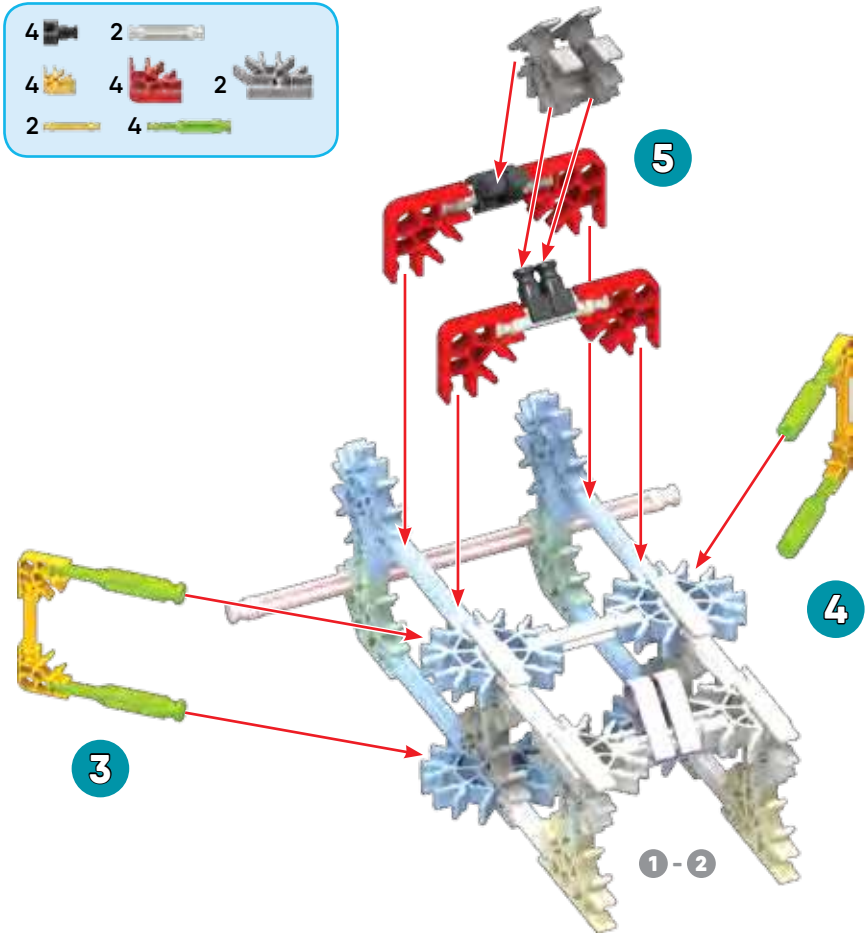

- | | | | |
|---|---|---|---|
| 6 | 7 | 2 | 8 |
| 4 | | | |
| 1 | | | |
| 2 | 2 | | 6 |

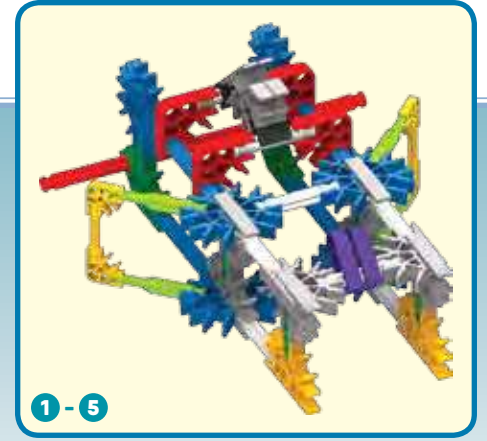
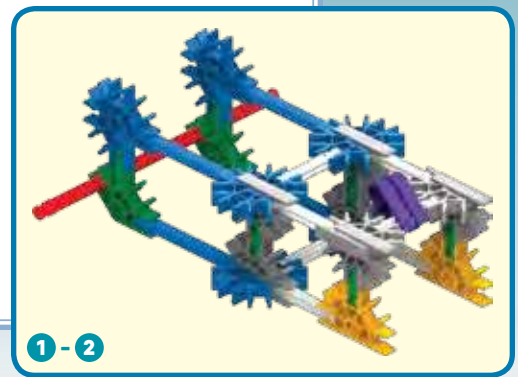
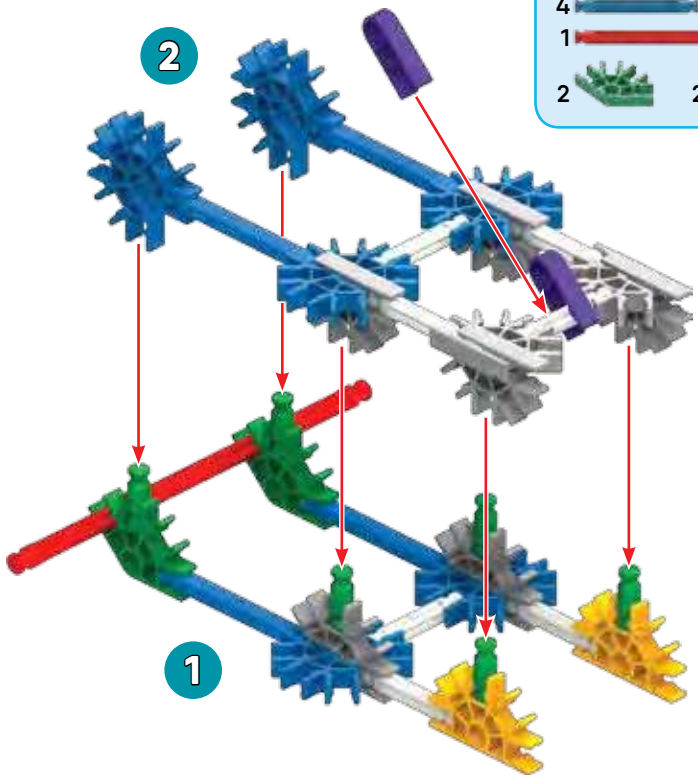

- | | |
|---|----|
| 2 | 4 |
| 8 | 8 |
| 1 | 10 |
| 2 | 6 |
| 1 | |

SWING RIDE

TOUR DE BALANÇOIRE

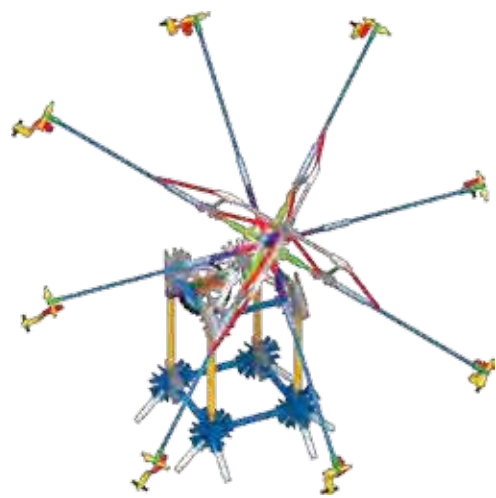

- | | | | |
|---|---|---|---|
| 1 | 1 | 1 | 1 |
| 2 | 1 | 1 | 1 |
| 1 | 7 | 1 | 1 |

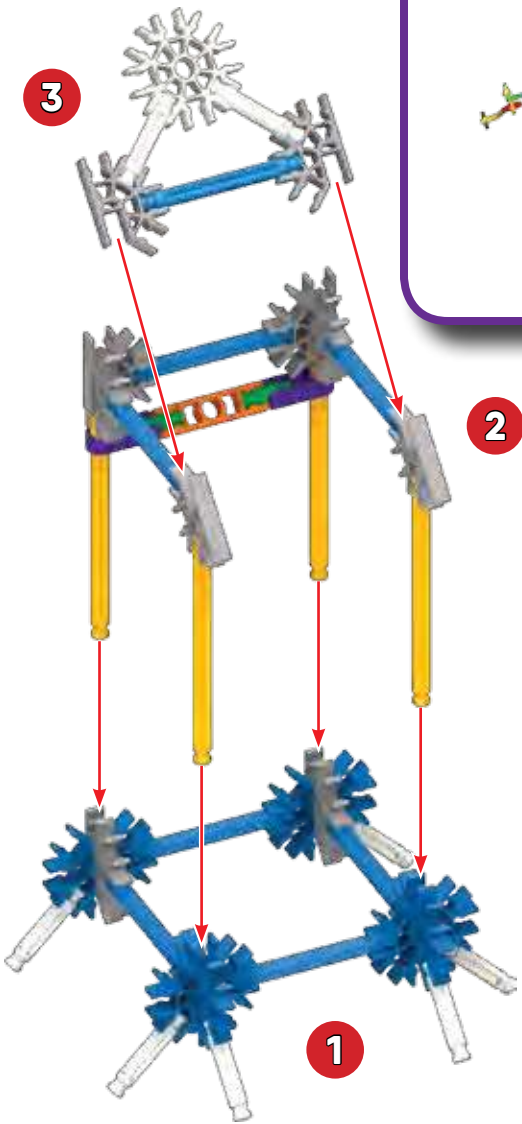

2

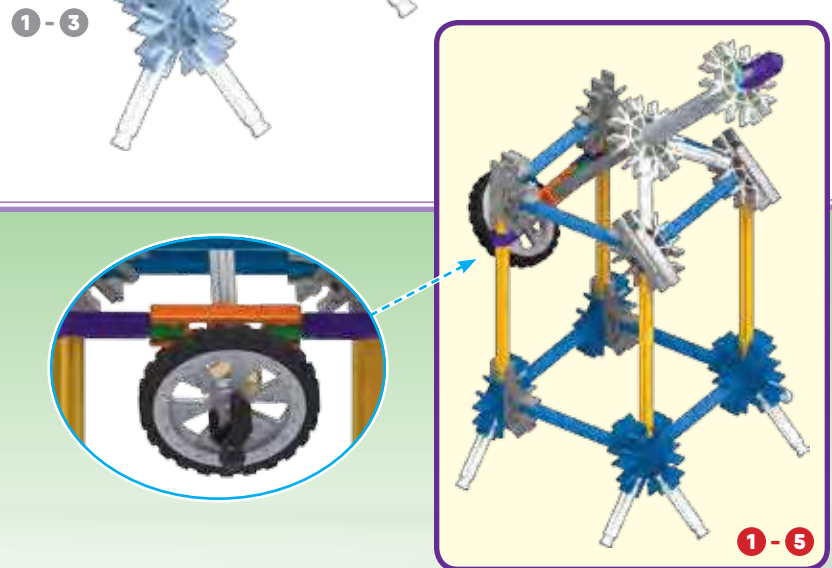
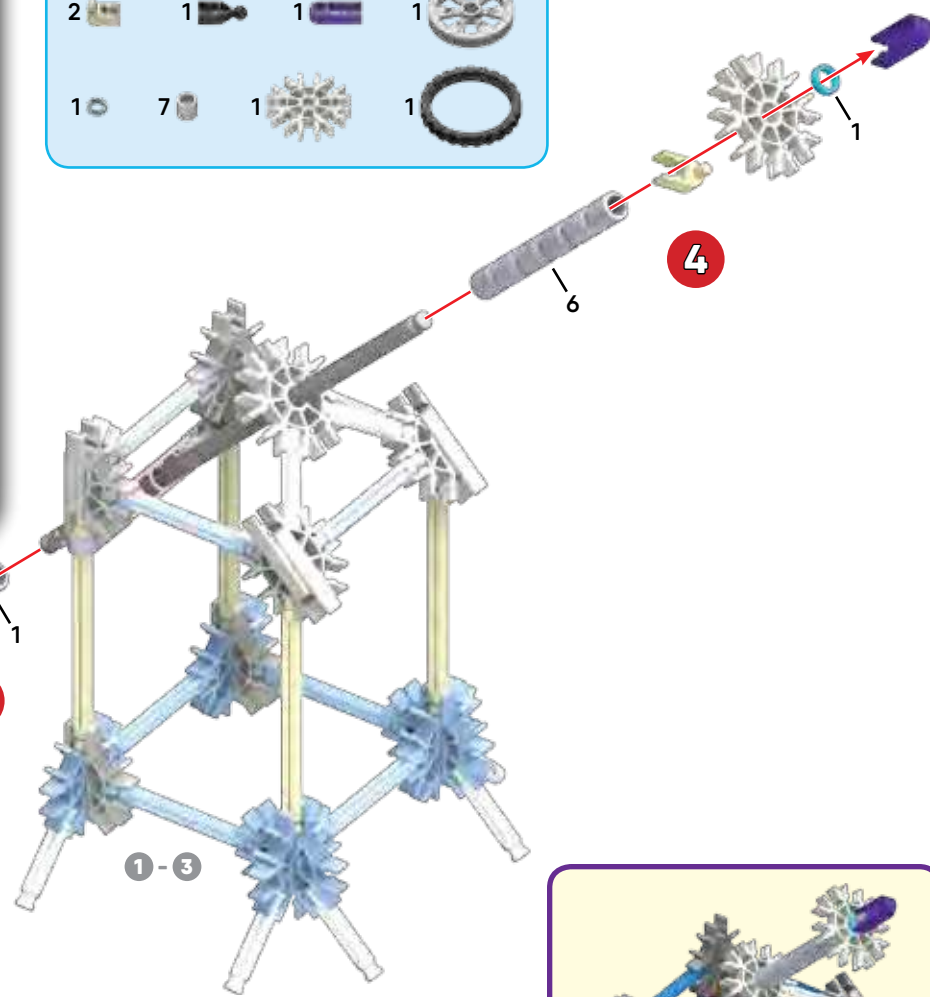
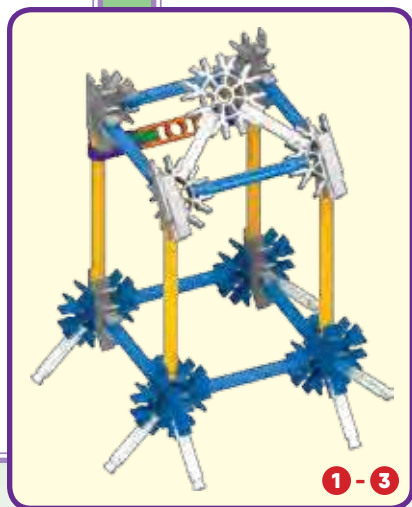

- 2
- 3
- 2
- 4
- 4
- 2

6

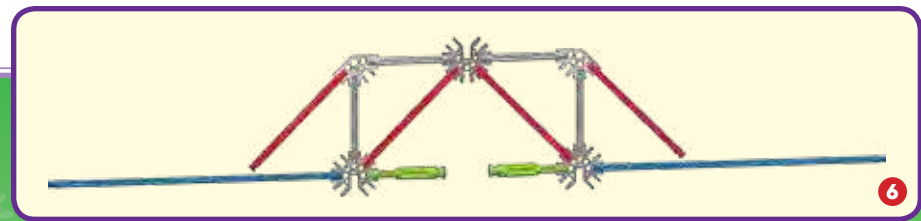
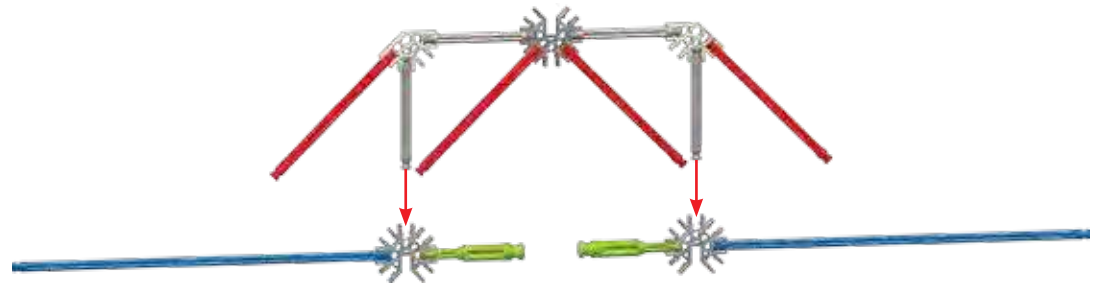

6

- 2
- 3
- 2
- 4
- 4
- 2

7

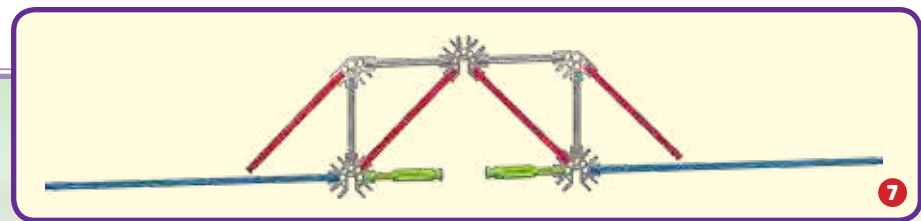
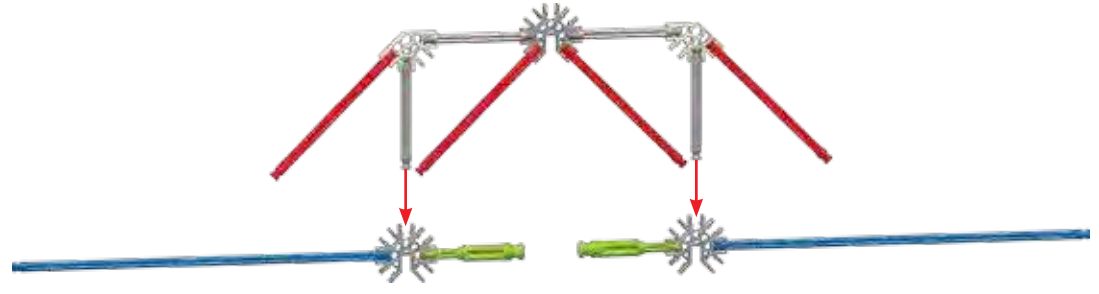

7

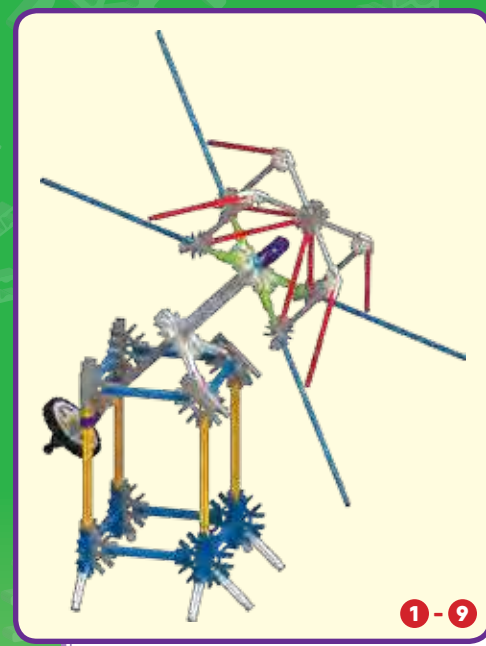

1-9

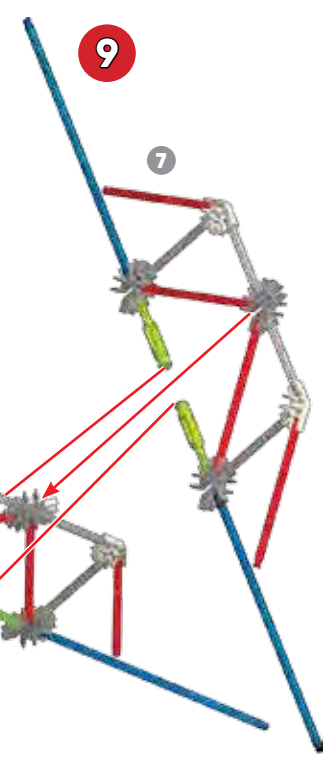

9

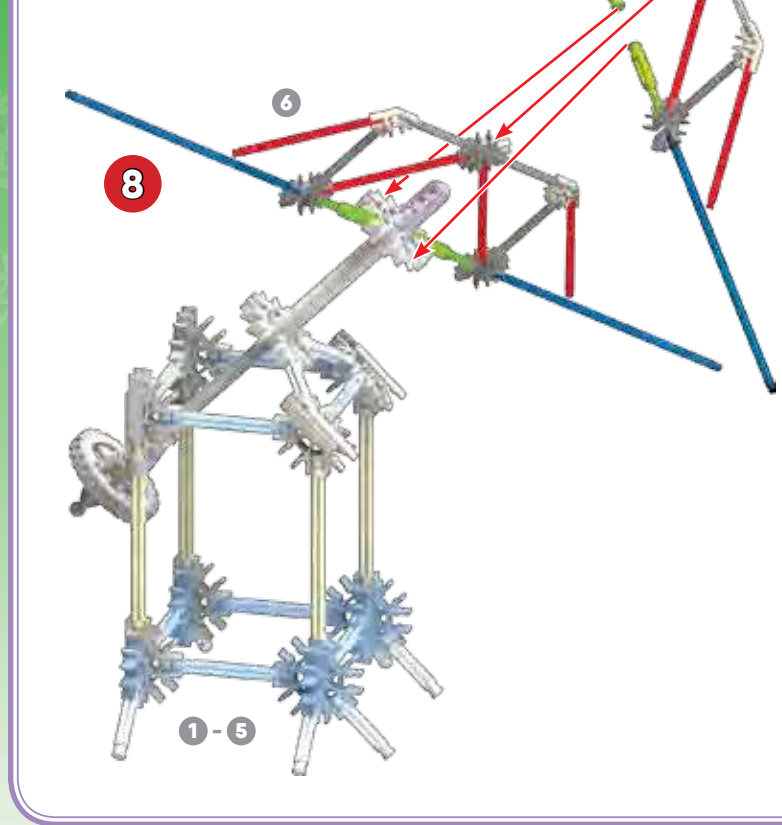

8

1-5

x4

10

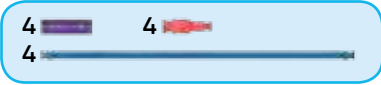

x4



10

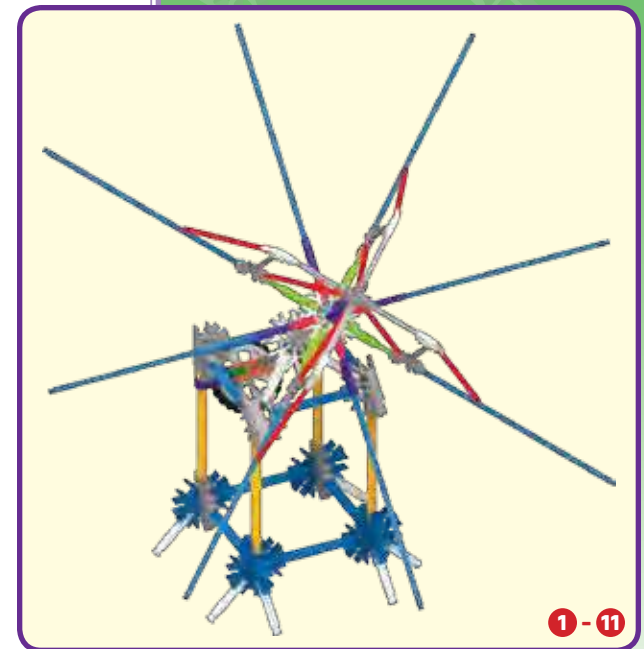
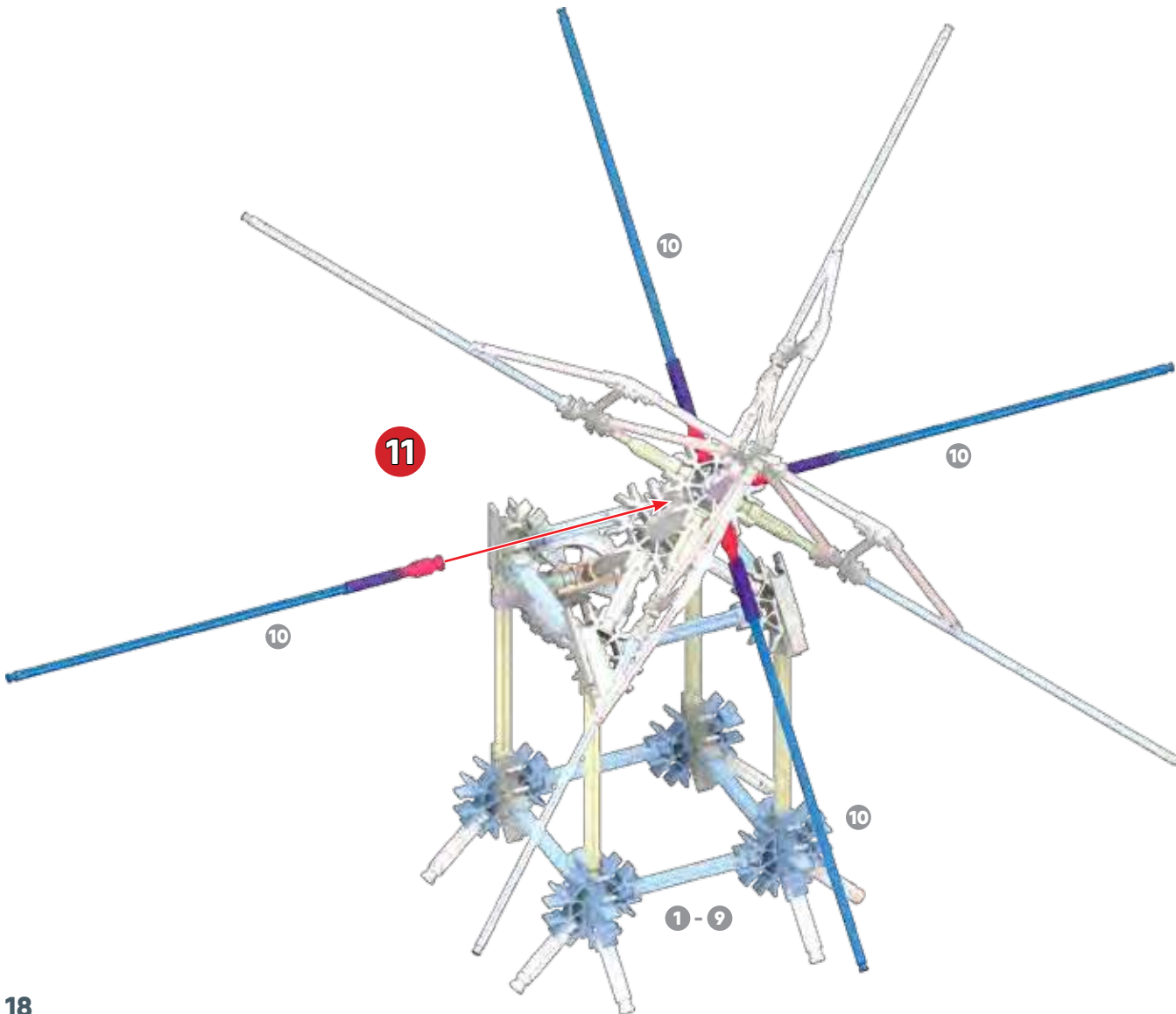

1-11

x8



12

x8

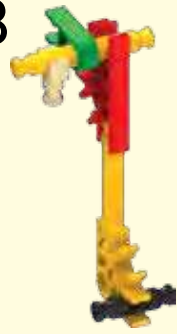

12

8	8
8	8
8	16

SWING RIDE
TOUR DE
BALANÇOIRE

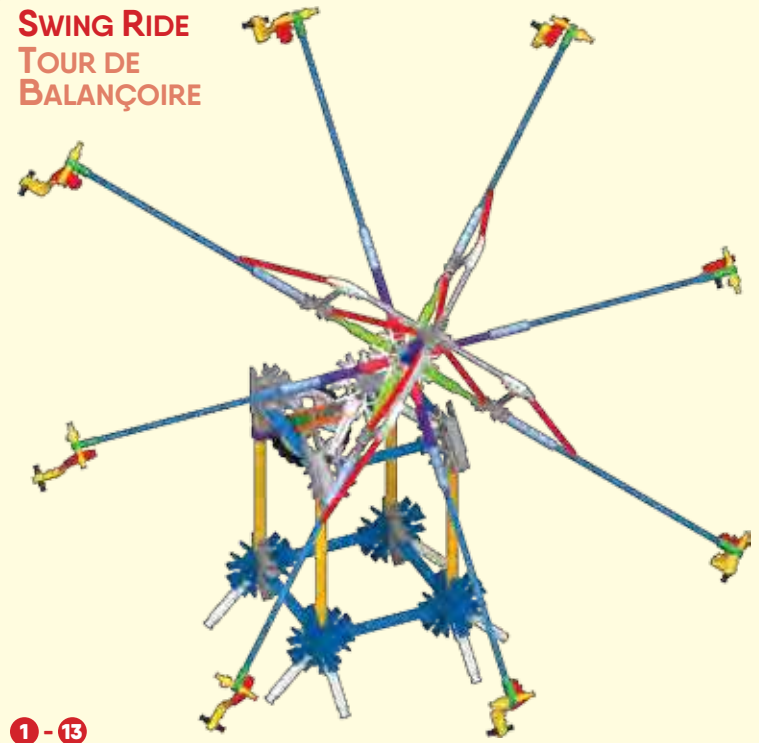

1-13

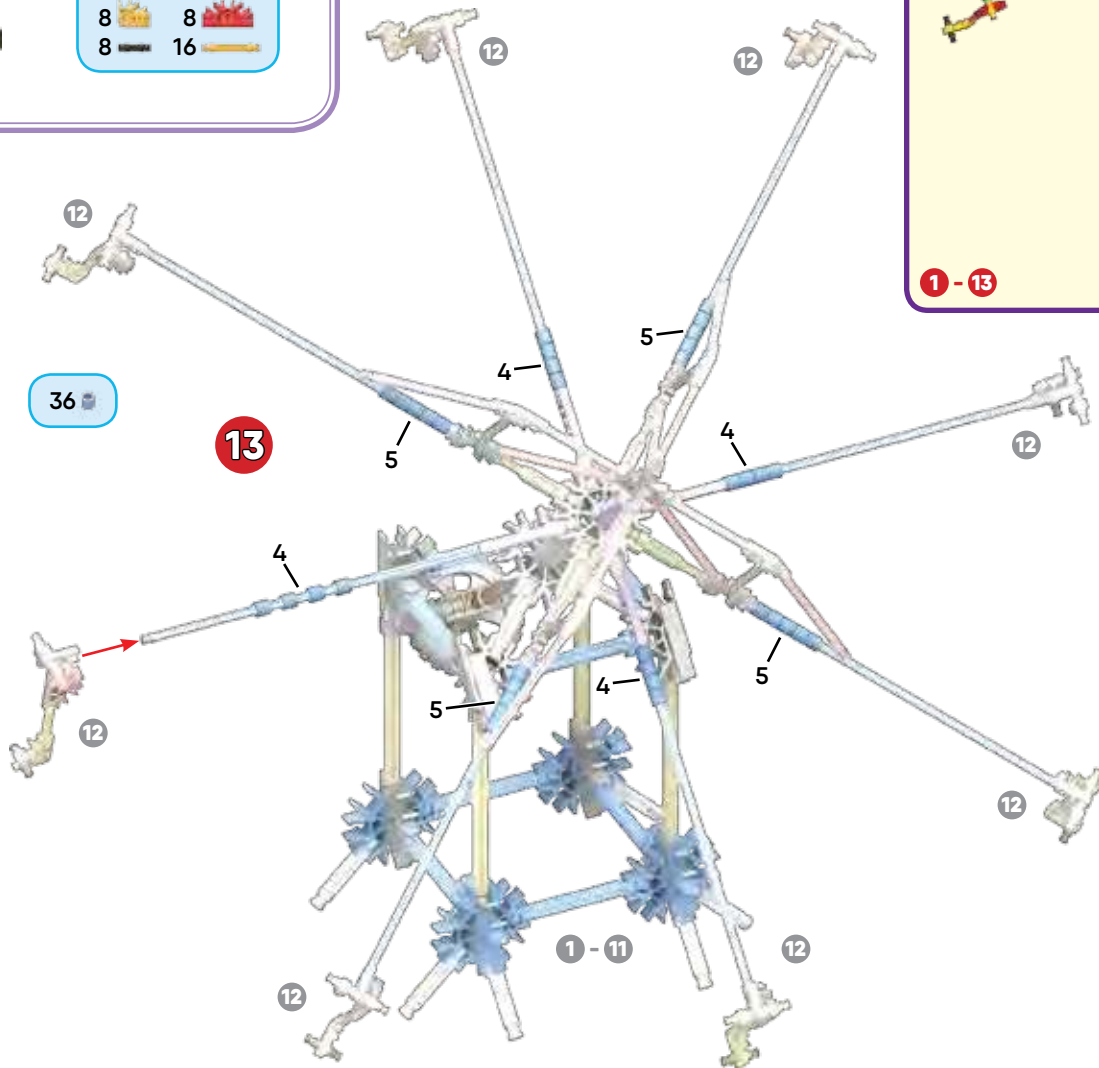

13

36

BUILDING IDEAS

For instructions of these models go to www.knex.com/instructions and enter code **17010**.

IDÉES DE CONSTRUCTION

Pour les instructions de ces modèles vont à www.knex.com/instructions et entrez dans le code **17010**.





(ES) **Español**

(Página 2)

Básicos de Construcción

Empieza a construir

Cada K'NEX pieza tiene su propia forma y color. Mientras construyes, trata de colocar tu modelo en la misma dirección que se muestra en las instrucciones. Los colores desenfocados muestran que esta sección ya está construida.

Conectores

Usted puede deslizar estos conectores especiales juntos. Empuje firmemente hasta que oiga un "clic".

Espaciadores

Asegúrese de usar el color correcto y el número de espaciadores que se muestra en las instrucciones.

(Página 3)

Lista de Piezas

Antes de empezar con la construcción, asegúrate de comparar las piezas en tu conjunto con la lista de las piezas aquí. Si faltan algunas, llámanos o escríbenos siguiendo las instrucciones en la página trasera. Estamos aquí para ayudarte.

(Página 20, 22)

IDEAS DE CONSTRUCCIÓN

Para obtener instrucciones de los estos modelos vaya a www.knex.com/instructions y entre en el código 17010.

(DE) **Deutsch**

(Seite 2)

Grundlegende Bauanleitungen für K'NEX

Los geht's mit dem Bauen

Jedes K'NEX Teil hat seine eigene Form und Farbe. Versuche, dein Modell beim Zusammenbauen so zu orientieren, dass es in die gleiche Richtung weist, wie es in den Anleitungen beschrieben und gezeigt wird. Blasse Farben weisen darauf hin, dass dieser Streckenabschnitt bereits zusammengebaut ist.

Verbindungsstücke

Verbindungsstücke haben besonders lange Schlitze. Achte beim Aneinanderfügen dieser Teile darauf, dass du ein Klickgeräusch hörst.

Abstandsstücke

Achte darauf, die richtige Farbe und Anzahl von Abstandsstücken wie in der Anleitung gezeigt zu verwenden.

(Seite 3)

Teileliste

Bevor du mit dem Bauen anfängst, solltest du prüfen ob die Teile in deinem Bausatz mit denen auf dieser Teileliste übereinstimmen. Falls etwas fehlt, rufe uns an oder schreibe uns (siehe Rückseite). Wir sind für dich da!

(Seite 20, 22)

BAUVORSCHLÄGE

Für Anweisungen dieser Modelle gehen sie zu www.knex.com/instructions und geben sie Code 17010 ein.

(IT) **Italiano**

(Pagina 2)

Istruzioni di base per costruire con K'NEX

Comincia a costruire

Ogni K'NEX pezzo ha una sua forma e un suo colore. Cerca di tenere il modello nella stessa direzione della figura e in tal modo sarà più semplice allegare i pezzi nei posti giusti. I colori spenti ti dicono che questa sezione è già stata costruita.

Connettori

È molto importante posizionare i connettori in una specifica direzione. Spingi con forza fino ad udire un clic.

Spaziatori

Accertati che usate il colore corretto e il numero di spaziatori mostrati nell'istruzioni.

(Página 3)

Elenco delle parti

Prima di cominciare a costruire, accertati di confrontare le parti che sono nel tuo set con l'elenco delle parti qui. Se ne manca una chiamaci o scrivicci usando le informazioni che sono nella retrocopertina. Noi siamo qui per aiutarvi!

(Página 20, 22)

IDEE DI COSTRUZIONE

Per istruzioni di questi modelli vai a www.knex.com/instructions inserire il codice 17010.

(PT) **Português**

(Página 2)

Pontos básicos para a construção K'NEX

Inicia a construção

Cada K'NEX peça tem a sua própria forma definida e cor. Enquanto estás a montar as peças, tenta manter o teu modelo na mesma direção, conforme mostrado na ilustração, para assim conectar as peças correctamente. As cores desbotadas indicam que esta secção já está construído.

Conectores

Empurre estes conectores especiais juntos firmemente até ouvir um "clique".

Espaçadores

Existirão certos pontos no teu modelo que necessitam a colocação de espaçadores. Certifique-se de contar com cuidado.

(Página 3)

Lista de peças

Antes de iniciares a construção, certifica-te de que comparas as peças do teu conjunto com a lista das peças aqui. Se está desaparecido uma peça telefona ou escreve-nos usando as informações indicadas na contracapa. Estamos aqui para te ajudar!

(Página 20, 22)

IDEIAS DE CONSTRUÇÃO

Para obter instruções destes modelos vá em www.knex.com/instructions e digite o código 17010.

(NL) **Nederlands**

(Bladzijde 2)

Basisstappen voor K'NEX bouwen

Begin te bouwen

Elk K'NEX stuk heeft zijn eigen vorm en kleur. Tracht je model in dezelfde richting te plaatsen als de aanwijzingen terwijl je bouwt en monteert. De vervaagde kleuren duiden aan dat dit deel reeds is opgebouwd.

Verbindingsstukken

Duw deze speciale verbindingsstukken stevig tegen elkaar aan tot je een 'klik' hoort.

Afstandhouders

Zorg dat je het juiste en kleur aantal afstandhouders gebruikt.

(Bladzijde 3)

Lijst met onderdelen

Zorg ervoor dat de onderdelen te vergelijken met de onderdelen hier op te sommen. Als er iets is ontbreekt, bel of schrijf ons gebruik van de informatie op de achterkant. Wij zijn hier om u te helpen!

(Bladzijde 20, 22)

BOUWIDEËN

Voor instructies van deze modellen naar www.knex.com/instructions en vul de code 17010.



BUILDER BASICS
Building Set

**ÉLÉMENTS ESSENTIELS
DE CONSTRUCTION**
Jeu de construction

knex.com

@knexbrands

facebook.com/knex



**SCIENCE/SCIENCE
TECHNOLOGY/TECNOLOGIE
ENGINEERING/INGÉNIERIE
ART & DESIGN/CONCEPTION & D'ART
MATH/MATHÉMATIQUES***



POWER & PLAY**
Motorized Building Set
**SUPER BOX AVEC
MOTEUR**
Jeu de construction motorisé



STEALTH PLANE**
Building Set
AVION FURTIF
Jeu de construction



MOTORCYCLE**
Building Set
MOTO
Jeu de construction



ROCKET CAR**
Building Set
VOITURE-FUSÉE
Jeu de construction



* Juego inspirado
Inspiriertes Spiel
Ha ispirato il gioco
Inspirou o jogo
Geïnspireerd spel

* Ciencia / Wissenschaft /
Scienza / Ciência / Wetenschap
Tecnologia / Technologie /
Tecnologia / Tecnología /
Technologie
Ingeniería / Ingenieurwesen /
Ingegneria / Engenharia /
Bouwkunde
Arte Y Diseño / Kunstdesign /
Arte E Design / Design de arte /
kunst En Ontwerp
Matemáticas / Mathematik /
Matematica / Matemática /
Wiskunde

** Sold separately
Vendus séparément
Se venden por separado
Separat erhältlich
Venduti separatamente
Vendidos separadamente
Afzonderlijk verkrijgbaar

©2017 K'NEX Limited Partnership Group, P.O. Box 700, Hatfield, PA 19440-0700; 1-800-KID-KNEX (USA / Canada / États-Unis / EE.UU.); email@knex.com; knex.com. K'NEX UK Ltd, 200 Brook Drive, Green Park, Reading, RG6 2UB England; K'NEX France, 24 rue du Quatre Septembre, 75002 Paris, France. For customers outside the USA / Canada please contact your local distributor at www.knex.com / distributors.

(FR) Pour les clients en dehors du Canada et des États-Unis, veuillez contacter votre distributeur local que vous pouvez trouver sur www.knex.com / distributors.

(ES) El cliente que no vive en EE.UU. / Canadá se pone en contacto con el distribuidor local. Encuentre la información para el distribuidor local en www.knex.com / distributors.

(EN) K'NEX is a registered trademark and Imagine and Steamagination are trademarks of K'NEX Limited Partnership Group.

(FR) K'NEX est une marque déposée et Imagine et Steamagination sont une marque de K'NEX Limited Partnership Group.

(ES) K'NEX es una marca registrada y Imagine y Steamagination son marcas de K'NEX Limited Partnership Group.

(EN) Product & colors may vary. Most models can be built one at a time.

(FR) Le produit et ses couleurs peuvent varier. Les différents modèles ne peuvent être construits qu'un par un.

(ES) El producto y los colores pueden variar. La mayoría de los modelos se pueden construir uno a la vez.

(DE) Produkte und Farben können abweichen. Die meisten Modelle können immer nur einzeln gebaut werden.

(IT) Prodotti e colori possono differire. La maggior parte dei modelli si può costruire autonomamente. Istruzioni accluse.

(PT) O produto e as cores podem variar. A maioria dos modelos pode ser montado um de cada vez.

(NL) Product en kleuren kunnen variëren. De meeste modellen kunnen uitsluitend een voor een worden gebouwd.

