



smartwares®



STAINLESS  
STEEL

**LED**  
LED READY



OUTDOOR  
USE



## Up and down wall light

NL Up and down wandlamp DE Wandleuchte FR De haut en bas murale  
ES Luz de pared exterior IT Applique da esterno PT Aplique Luz Exterior SV Upp och ner vägglampa  
TR Dışmekan duvar lambası PL W górę iw dół światła na ścianie

2605.010L - 10.045.54

2x GU10 max. 20W  
230V~ 50 Hz



EU address:		UK address:	
smartwares Europe	Jules Verneweg 87 5015 BH Tilburg The Netherlands www.smartwares.eu	smartwares Safety and Lighting Ltd.	Meriden House, 6 Great Combow Halesowen, West Midlands, B63 3AB United Kingdom

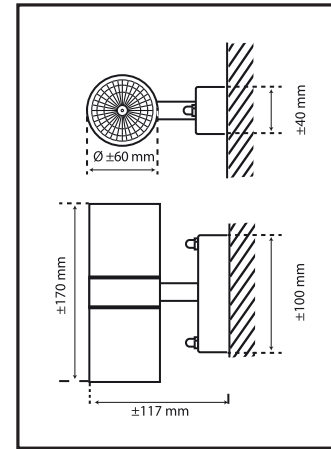
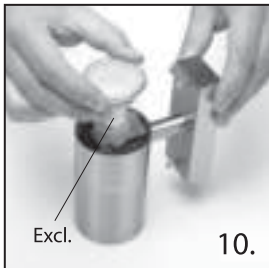
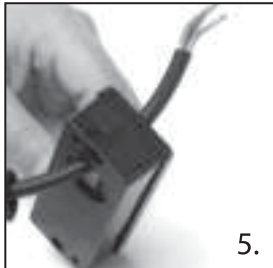
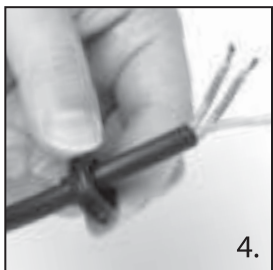
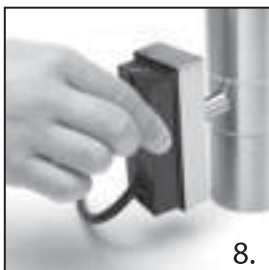
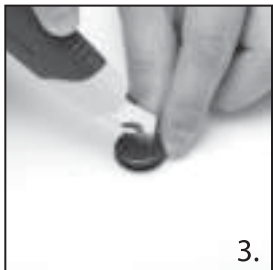
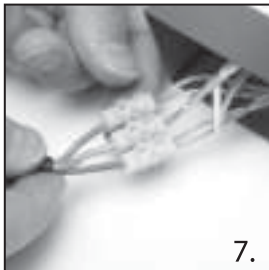
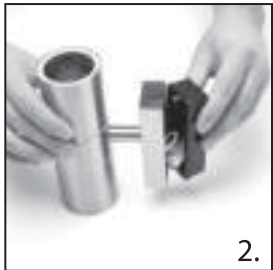
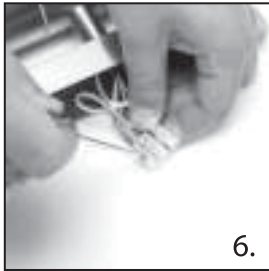

**IP44**



- GB** The fixture is splash-proof.
- NL** Het armatuur is spatwaterdicht.
- F** L'armature est étanche aux projections d'eau.
- D** Die Armatur ist spritzwasserdicht.
- N** Armaturet er beskyttet mot sprut.
- S** Armaturen är tät mot stänkvatten.
- DK** Armaturet er stænktæt.
- FIN** Valaisin on roiskevedenpitävä.
- PL** Urządzenie jest bryzgoszczelne.
- RUS** Осветительная арматура является брызгозащищенной.
- BG** Осветителното тяло е устойчиво на намокряне.
- H** A szerelvény fröccsenésálló.
- RO** Corpul de iluminat este rezistent la stropire.
- SK** Zariadenie je chránené proti postriekaniu.
- HR** Svjetiljka je zaštićena protiv štrcanja vode.
- CZ** Zařízení je chráněno proti postřiku.
- SLO** Nosilec je odporen proti curkom.
- I** La lampada è protetta contro gli spruzzi d'acqua.
- P** A ferragem de conexão é a prova de salpicos.
- E** El montaje está protegido contra salpicaduras.
- GR** Η εφαρμογή είναι αδιάβροχη στα πισίσιμα.
- TR** Tertibat sýçramalara karpý dayanýklýdýr.
- GB** Protection class 1: the fitting must be earthed.
- NL** Beschermklasse 1, het armatuur moet geaard worden.
- F** Classe de sécurité 1, l'armature doit être mise à la terre.
- D** Schutzklasse 1, die Armatur muss geerdet werden.
- N** Beskyttelsesklasse 1: armaturet må jordes.
- S** Skyddsklass 1, armaturen måste jordas.
- DK** Beskyttelsesklasse 1, armaturet skal have jordforbindelse.
- FIN** Suojausluokka 1, valaisin pitää maadoittaa.
- PL** Klasa zabezpieczenia 1: urządzenie musi być uziemione.
- RUS** Класс защиты 1: арматура должна быть заземлена.
- BG** Защита от клас 1: осветителното тяло трябва да е заземено.
- H** 1. védelmi osztály: a szerelvény földelhető.
- RO** Clasă 1 de protecție: corpul de iluminat trebuie împământat.
- SK** Trieda ochrany 1: zariadenie musí byť uzemnené.
- HR** Klasa zaštite 1: svjetiljka mora biti uzemljeno.
- CZ** Třída ochrany 1: zařízení musí být uzemněno.
- SLO** Zaščitni razred 1: nosilec senzorja je potrebno ozemljiti.
- I** Classe di protezione 1, la lampada deve avere la messa a terra.
- P** Classe 1 de protecção: a ferragem de conexão deve ser ligada à terra.
- E** Protección de Clase 1: el montaje debe estar conectado a tierra.
- GR** Προστατευτικό γυαλί 1: η εφαρμογή πρέπει να γειωθεί.
- TR** Emniyet türü 1: Tertibat topraklanmalıdır.