

OLYMPUS

DIGITAL CAMERA

E-M10 Mark III

Instruction Manual

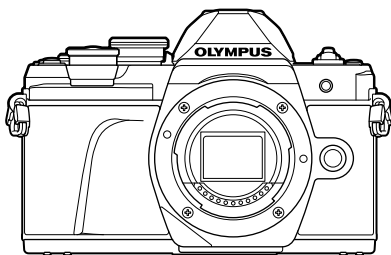

Table of Contents

Quick task index

1. Preparation
2. Shooting
3. Playback
4. Menu functions
5. Connecting the camera to a smartphone
6. Connecting the camera to a computer and a printer
7. Cautions
8. Information
9. SAFETY PRECAUTIONS
10. Additions/modifications by firmware update

CE

Model No. : IM006

- Thank you for purchasing an Olympus digital camera. Before you start to use your new camera, please read these instructions carefully to enjoy optimum performance and a longer service life. Keep this manual in a safe place for future reference.
- We recommend that you take test shots to get accustomed to your camera before taking important photographs.
- The screen and camera illustrations shown in this manual were produced during the development stages and may differ from the actual product.
- If there are additions and/or modifications of functions due to firmware update for the camera, the contents will differ. For the latest information, please visit the Olympus website.

Indications used in this manual

The following symbols are used throughout this manual.











 Notes	Points to note when using the camera.
 Tips	Useful information and hints that will help you get the most out of your camera.
	Reference pages describing details or related information.

Table of Contents

Quick task index	7	Choosing shutter speed (Shutter Priority mode)	47
Names of parts	10	Choosing aperture and shutter speed (Manual mode)...	48
Preparation	12	Shooting with long exposure time (BULB/LIVE TIME)	49
■ Unpacking the box contents	12	Live composite photography (dark and light field composite)	50
■ Charging and inserting the battery	13	Shooting with touch screen operations	51
■ Inserting the card	15	■ Recording movies	52
Removing the card	15	Recording movies in photo shooting modes	52
■ Attaching a lens to the camera	16	Recording movies in movie mode	53
■ Turning the camera on	18	Using the silencing function when shooting a movie	59
■ Setting the date/time	19	■ Using various settings	60
Shooting	20	Controlling exposure (Exposure )	60
■ Information displays while shooting	20	Locking the exposure (AE Lock)	60
■ Switching between displays	22	Digital Zoom (Digital Tele-converter)	60
Switching the information display	23	Selecting the AF target mode (AF target settings)	61
■ Shooting still pictures	24	Setting the AF target	61
Switching Displays with the  (Shortcut) Button	26	Face priority AF/ Eye priority AF	62
Letting the camera choose the settings (AUTO mode)	27	Changing ISO sensitivity (ISO)	63
Shooting in scene mode (SCN mode)	29	Using a flash (Flash photography)	64
Shooting in advanced photo mode (AP mode)	32	Performing the sequential/ self-timer shooting	66
Using art filters (ART mode)	42		
Letting the camera choose aperture and shutter speed (Program mode)	45		
Choosing aperture (Aperture Priority mode)	46		

Calling shooting options	67	Adjusting i-Enhance effects (Effect)	83
Processing options (Picture Mode)	69	Setting the color reproduction format (Color Space)	84
Adjusting color (WB (white balance))	70	Changing the brightness of highlights and shadows (Highlight&Shadow Control)	84
Choosing a focus mode (AF Mode)	72	Assigning functions to buttons (Button Function)	85
Setting the image aspect	73		
Selecting image quality (Still image quality,  )	73	Playback	88
Selecting image quality (Movie quality,  )	74	Information display during playback	88
Adding effects to a movie	76	Playback image information	88
Adjusting flash output (Flash intensity control)	77	Switching the information display	89
Reducing camera shake (Image Stabilizer)	78	Viewing photographs and movies	90
Making fine adjustments to white balance (WB Compensation)	79	Index display/ Calendar display	91
Choosing how the camera measures brightness (Metering)	80	Viewing still images	91
Making fine adjustments to sharpness (Sharpness)	80	Watching movies	93
Making fine adjustments to contrast (Contrast)	81	Protecting images	93
Making fine adjustments to saturation (Saturation)	81	Erasing an image	94
Making fine adjustments to tone (Gradation)	82	Selecting images ( , Erase Selected, Share Order Selected)	94
Applying filter effects to monochrome pictures (Color Filter)	82	Setting a transfer order on images (Share Order)	94
Adjusting the tone of a monochrome image (Monochrome Color)	83	Audio recording	95
		Audio Playback	95
		Adding still pictures to My Clips (Add to My Clips)	95
		Using the touch screen	96
		Selecting and protecting images	96

Menu functions	97
■ Basic menu operations	97
■ Using Shooting Menu 1/ Shooting Menu 2	98
Returning to default settings (Reset).....	98
Processing options (Picture Mode).....	99
Digital Zoom (Digital Tele-converter)	99
Improving Focus in Dark Surroundings (AF Illuminator).....	99
Choosing a Zoom Speed (📷 Elec. Zoom Speed)	100
Shooting automatically with a fixed interval (Intrvl. Sh./Time Lapse)	100
■ Using the Video Menu	102
■ Using the Playback Menu	103
Displaying images rotated (🔄).....	103
Editing still images (Edit)	103
Saving a still image from a movie (In-Movie Image Capture).....	105
Trimming movies (Movie Trimming).....	106
Canceling all protections	106
■ Using the setup menu	107
Formatting the card (Card Setup).....	108
Deleting all images (Card Setup).....	108
■ Using the custom menus	109
A AF/MF.....	109
B Button/Dial.....	109

C1 Disp/(📷)/PC	110
C2 Disp/(📷)/PC	110
D1 Exp/ISO/BULB	111
D2 Exp/ISO/BULB	111
E ⚡ Custom	112
F ⏪-/WB/Color	112
G Record.....	113
H EVF	114
I 📷 Utility	114
AEL/AFL	115
MF Assist.....	115
Adding information displays....	116
Viewing camera images on TV	118
Shutter speeds when the flash fires	119
Combinations of JPEG image sizes and compression rates.....	119

Connecting the camera to a smartphone 120

■ Connecting to a smartphone ...	121
■ Transferring images to a smartphone	122
■ Shooting remotely with a smartphone	122
■ Adding position information to images	123
■ Changing the connection method	123
■ Changing the password	124
■ Canceling a share order	124
■ Initializing wireless LAN settings	124

Connecting the camera to a computer and a printer 125

- Connecting the camera to a computer 125
- Copying pictures to a computer 125
- Installing the PC software 126
- Installing the OLYMPUS Digital Camera Updater 126
- User Registration 126
- Direct printing (PictBridge) 127
 - Easy printing 128
 - Custom printing 128
- Print order (DPOF) 130
 - Creating a print order 130
 - Removing all or selected pictures from the print order ... 131

Cautions 132

- Battery and charger 132
- Using your charger abroad 133
- Usable cards 133
- Record mode and file size/ number of storable still pictures 134
- Interchangeable lenses 135
- External flash units designated for use with this camera 136

- Other external flash units 137
- Principal Accessories 137
- System chart 138
- Cleaning and storing the camera 140
 - Cleaning the camera 140
 - Storage 140
 - Cleaning and checking the image pickup device 140
 - Pixel Mapping - Checking the image processing functions 141

Information 142

- Shooting tips and information 142
- Error codes 145
- Defaults 148
- Specifications 152

SAFETY PRECAUTIONS 155

- SAFETY PRECAUTIONS 155

Additions/modifications by firmware update 165

Index 168

Quick task index

Shooting



Choosing an aspect ratio	▶ Aspect ratio	73
Correcting the effects of perspective	▶ Keystone Compensation	39
Automatically adjusting exposure over a series of photos	▶ AE Bracketing	40
Automatically shifting the focus position over a series of photos	▶ Multi focus shot (SCN)	29
	▶ Focus bracketing (IAF)	41
Making photos brighter or darker	▶ Exposure compensation	60
	Light Trails (SCN)	29
	Live Time (IAF)	34
	▶ Live Composite (IAF)	33
	Live Composite (M)	50
	Bulb/time photography (M)	49
Taking pictures with a blurred background	▶ Aperture priority shooting	46
Taking pictures that stop the subject in motion or convey a sense of motion	▶ Shutter priority shooting	47
	▶ Scene mode (SCN)	29
Getting the desired colors	▶ White balance	70
Processing pictures to match the subject/Taking monotone pictures	▶ Picture Mode	69
	▶ Art filter (ART)	42
When the camera will not focus on your subject/Focusing on one area	Using the touch screen	51
	▶ AF target settings	61
	Zoom frame AF/zoom AF	87
Focusing on a small spot in the frame/confirming focus before shooting	▶ Zoom frame AF/zoom AF	87
Keeping a moving subject in focus	▶ C-AF+TR (AF tracking)	72
Taking pictures of a subject against backlight	Flash shooting	64
	▶ Backlight HDR (SCN)	29
	Gradation (Picture Mode)	82

Optimizing the monitor/ adjusting monitor hue	▶ Monitor brightness adjustment	107
	▶ Live View Boost	110
Photographing fireworks	▶ Fireworks (SCN)	29
	▶ Live Time (AP)	34
	▶ Live Composite (AP)	33
	▶ Live Composite (M)	50
	▶ Bulb/time photography (M)	49
Checking horizontal or vertical orientation before shooting	▶ Level gauge	23
Shooting with deliberate composition	▶ Displayed Grid	110
Sequential shooting	▶ Sequential shooting	66
Using a remote control	▶ Shooting remotely with a smartphone	122
Shooting without the shutter sound	▶ Silent [▼] (SCN)	29
	▶ Silent [▼] (AP)	37
Creating commercial-style movies	▶ My Clips	56





Playback/Retouch



Viewing images on a TV	▶ HDMI	110
	▶ Playback on TV	118
Viewing slideshows with background music	▶ Slideshow	92
Brightening shadows	▶ Shadow Adj (JPEG Edit)	104
Dealing with red-eye	▶ Redeye Fix (JPEG Edit)	104
Printing made easy	▶ Direct printing	127
Viewing pictures on a smartphone	▶ Transferring images to a smartphone	122
Adding location data to images	▶ Adding location data to images	123

Camera Settings



Synchronizing the date and time	▶ Setting the date/time	19
Restoring default settings	▶ Reset	98
Preventing automatic display switching	▶ EVF Auto Switch	22, 114
Changing the menu display language	▶ 	107
Turning off the auto focus sound	▶  (Beep sound)	110
	▶ Silent [] (SCN)	29
	▶ Silent [] (AP)	37

Names of parts

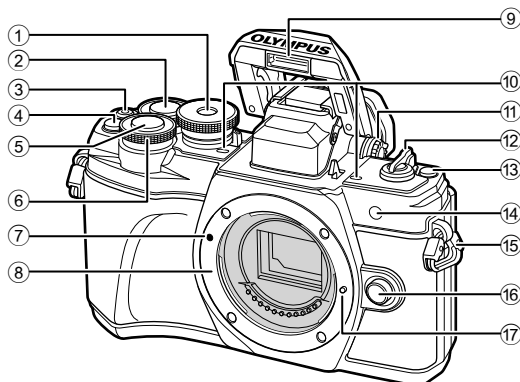

- | | |
|--|--|
| ① Mode dialP. 24 | ⑨ Internal flashP. 64 |
| ② Rear dial* (☺) | ⑩ Stereo microphoneP. 95, 102, 104 |
|P. 45–48, 90 | ⑪ Diopter adjustment dialP. 22 |
| ③ (Movie)/ buttonP. 52/P. 94 | ⑫ ON/OFF leverP. 18 |
| ④ (Digital Tele-converter)/ Fn2 button | ⑬ (Shortcut) buttonP. 26 |
|P. 60/P. 85, 90 | ⑭ Self-timer lamp/AF illuminator |
| ⑤ Shutter buttonP. 25 |P. 66/P. 99 |
| ⑥ Front dial* (☺) | ⑮ Strap eyelet.....P. 12 |
|P. 45–48, 60, 64, 90 | ⑯ Lens release buttonP. 17 |
| ⑦ Lens attachment markP. 16 | ⑰ Lens lock pin |
| ⑧ Mount (Remove the body cap before attaching the lens.) | |

* In this manual, the ☺ and ☹ icons represent operations performed using the front dial and rear dial.

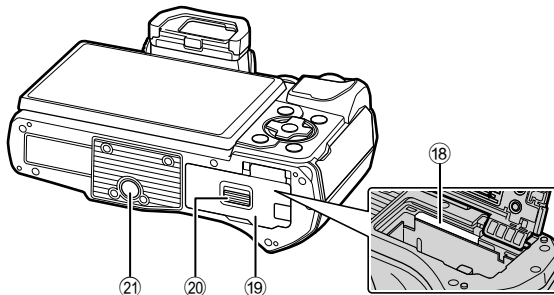
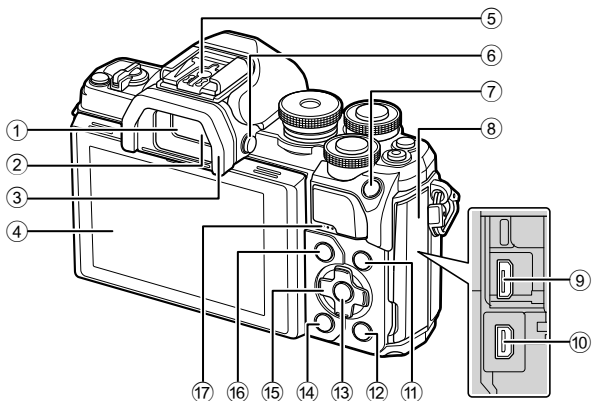

- | | |
|--|--|
| ① ViewfinderP. 22 | ⑫ (Playback) button.....P. 90 |
| ② Eye sensor.....P. 22, 144 | ⑬ (OK) buttonP. 67, 90, 97 |
| ③ Eyecup.....P. 137 | ⑭ (Erase) buttonP. 94 |
| ④ Monitor (Touch screen)
.....P. 20, 22, 51, 67, 88, 96 | ⑮ Arrow pad* () |
| ⑤ Hot shoeP. 136 |P. 19, 61–66, P. 90 |
| ⑥ (Monitor) buttonP. 22 | ⑯ MENU button.....P. 97 |
| ⑦ AEL/AFL / Fn1 button
.....P. 60, 115/P. 85 | ⑰ Speaker |
| ⑧ Connector cover | ⑱ Card slotP. 15 |
| ⑨ Micro-USB connector.....P. 125, 127 | ⑲ Battery/card compartment cover
.....P. 13, 15 |
| ⑩ HDMI micro connector.....P. 118 | ⑳ Battery/card compartment lock
.....P. 13, 15 |
| ⑪ INFO button.....P. 23, 89, 116 | ㉑ Tripod socket |

* In this manual, the icons represent operations performed using the arrow pad.

1 Preparation

1

Preparation

Unpacking the box contents

The following items are included with the camera.
If anything is missing or damaged, contact the dealer from whom you purchased the camera.



Camera



Body cap



Strap

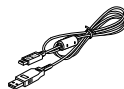

USB cable
CB-USB12



Lithium-ion battery
BLS-50

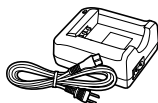

Lithium-ion charger
BCS-5

- Basic Manual
- Warranty card

Attaching the strap

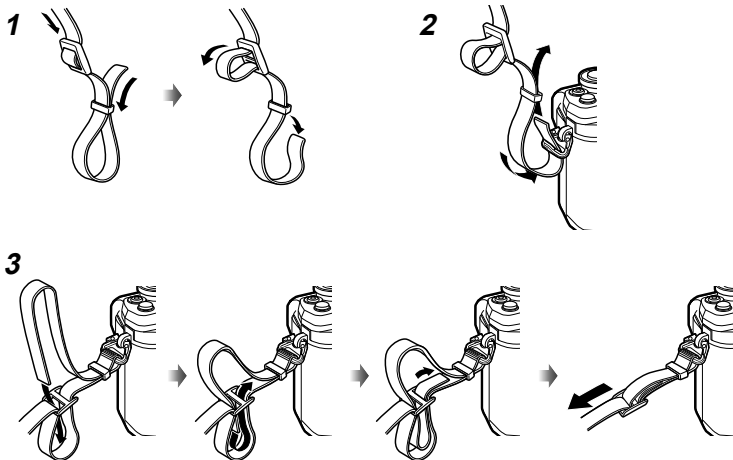

- Attach the strap on the other side in the same way.
- Lastly, pull the strap firmly, making sure that it is fastened securely.

Charging and inserting the battery

1 Charging the battery.

Charging indicator

Charging in progress	Lights orange
Charging complete	Off
Charging error	Blinks orange

(Charging time: Up to approximately 3 hours 30 minutes)

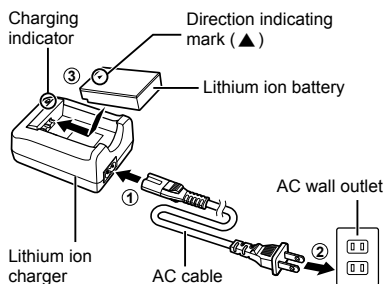

- Unplug the charger when charging is complete.

2 Opening the battery/card compartment cover.

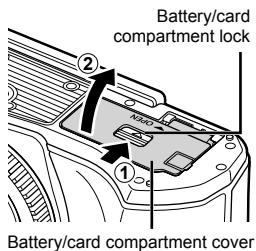

3 Loading the battery.

- Use only BLS-50 batteries (P. 12, 154).

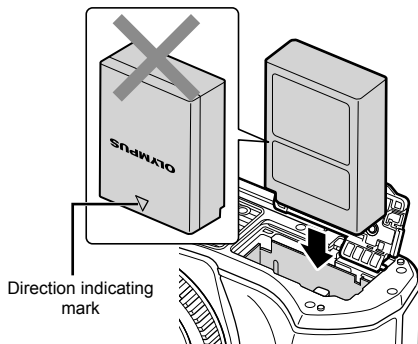

Removing the battery

Turn off the camera before opening or closing the battery/card compartment cover. To remove the battery, first push the battery lock knob in the direction of the arrow and then remove.

- Do not remove the battery while the card write indicator is displayed (P. 20).
- Contact an authorized distributor or service center if you are unable to remove the battery. Do not use force.

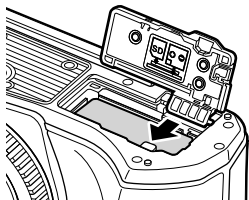

Notes

- It is recommended to set aside a backup battery for prolonged shooting in case the battery in use drains.
- The camera is not equipped with a built-in charger and cannot be recharged via a USB connection.
- Also read "Battery and charger" (P. 132).

Inserting the card

In this manual, all storage devices are referred to as “cards.”

The following types of SD memory card (commercially available) can be used with this camera: SD, SDHC, SDXC, and Eye-Fi.

1

Preparation

Eye-Fi cards

Read “Usable cards” (P. 133) before use.

1 Loading the card.

- Open the battery/card compartment cover.
- Slide the card in until it is locked into place.

☞ “Usable cards” (P. 133)

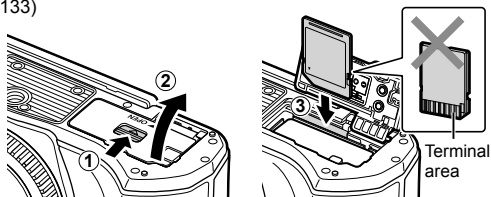

- Turn off the camera before loading or removing the battery or card.
- Do not forcibly insert a damaged or deformed card. Doing so may damage the card slot.

2 Closing the battery/card compartment cover.

- Be sure the battery/card compartment cover is closed before using the camera.

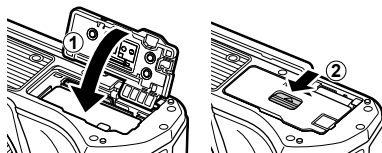

Removing the card

Press the inserted card lightly and it will be ejected. Pull out the card.

- Do not remove the card while the card write indicator is displayed (P. 20).

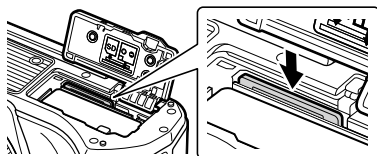

Attaching a lens to the camera

- 1 Remove the rear cap of the lens and the body cap of the camera.

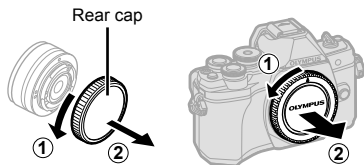

- 2 Align the lens attachment mark (red) on the camera with the alignment mark (red) on the lens, then insert the lens into the camera's body.

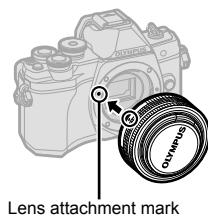

- 3 Rotate the lens clockwise until you hear it click (direction indicated by arrow 3).



- Make sure the camera is turned off when attaching or removing the lens.
- Do not press the lens release button.
- Do not touch internal portions of the camera.

■ Removing the lens cap

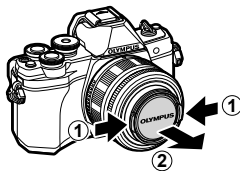
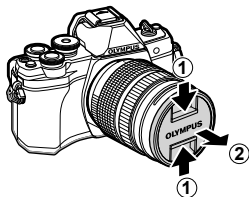

■ Removing the lens from the camera

Make sure the camera is turned off when removing the lens. While pressing the lens release button, rotate the lens in the direction of the arrow.

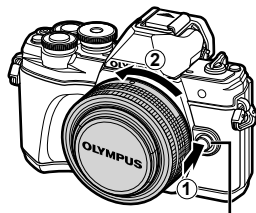

Lens release button

Interchangeable lenses

Read "Interchangeable lenses" (P. 135).

Turning the camera on

1 Set the **ON/OFF** lever to the **ON** position.

- When the camera is turned on, the monitor will turn on.
- To turn the camera off, return the lever to the **OFF** position.

■ ON/OFF lever

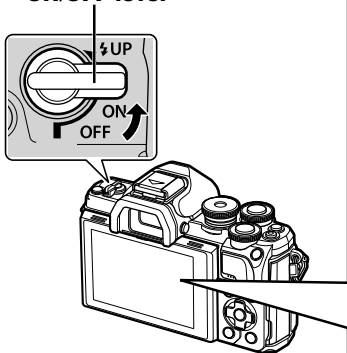

■ Monitor

Battery level

The battery level icon will be displayed.

- (green): The camera is ready to shoot.
- (green): The battery is not full.
- (green): The battery is low.
- (blinks red): Charge the battery.



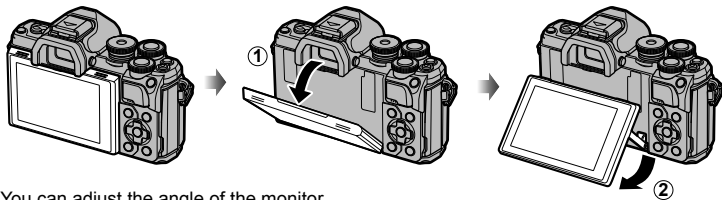

Using the monitor



You can adjust the angle of the monitor.

Camera sleep operation

If no operations are performed for a minute, the camera enters "sleep" (stand-by) mode to turn off the monitor and to cancel all actions. The camera activates again when you touch any button (the shutter button,  button, etc.). The camera will turn off automatically if left in sleep mode for 4 hours. Turn the camera on again before use. You can choose how long the camera remains idle before entering sleep mode.  [Sleep] (P. 114)

Setting the date/time

Date and time information is recorded on the card together with the images. The file name is also included with the date and time information. Be sure to set the correct date and time before using the camera. Some functions cannot be used if the date and time have not been set.

1 Display the menus.

- Press the **MENU** button to display the menus.
- A guide is displayed in 2 seconds after you select an option.
- Press the **INFO** button to view or hide guides.

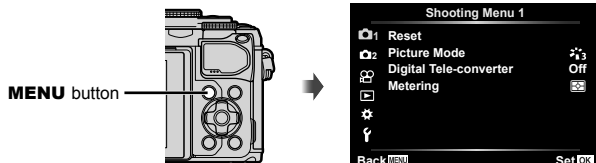

2 Select [Ⓞ] in the [f] (setup) tab.

- Use Δ ∇ on the arrow pad to select [f] and press \triangleright .
- Select [Ⓞ] and press \triangleright .

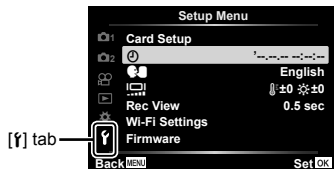

3 Set the date, time, and date format.

- Use \triangleleft \triangleright to select items.
- Use Δ ∇ to change the selected item.
- Press the **[OK]** button to set the camera clock.

4 Select [🌐] (changing the display language) in the [f] (setup) tab.

- You can change the language used for the on-screen display and error messages from English to another language.
- Use Δ ∇ \triangleleft \triangleright to highlight a language and press the **[OK]** button to select the highlighted language.

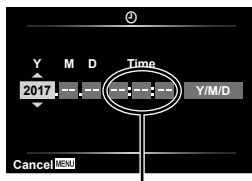

The time is displayed using a 24-hour clock.

5 Press the **MENU** button to exit the menus.

- If the battery is removed from the camera and the camera is left for a while, the date and time may be reset to the factory default setting.

2 Shooting

Information displays while shooting

Monitor display during still photography

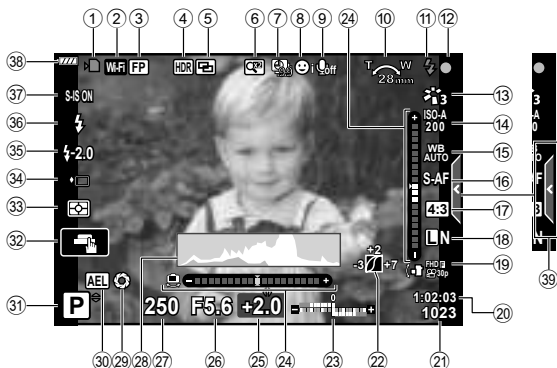

- | | |
|--|---|
| ① Card write indicator.....P. 14, 15 | ⑲ Record mode (movies)P. 74 |
| ② Wireless LAN connection.....P. 120–124 | ⑳ Available recording timeP. 134 |
| ③ Super FP flashP. 136 | ㉑ Number of storable still pictures ...P. 134 |
| ④ HDR.....P. 36 | ㉒ Highlight & shadow controlP. 84 |
| AE BracketingP. 40 | ㉓ Top: Flash intensity controlP. 77 |
| Focus Bracketing.....P. 41 | Bottom: Exposure compensation.....P. 60 |
| ⑤ Multiple exposure.....P. 35 | ㉔ Level gaugeP. 23 |
| Keystone compensationP. 39 | ㉕ Exposure compensation value.....P. 60 |
| ⑥ Digital Tele-converterP. 99 | ㉖ Aperture valueP. 45–48 |
| ⑦ Time lapse shooting.....P. 100 | ㉗ Shutter speedP. 45–48 |
| ⑧ Face priority/Eye priorityP. 62 | ㉘ HistogramP. 23 |
| ⑨ Movie soundP. 52, 102 | ㉙ PreviewP. 86 |
| ⑩ Zoom operation direction/
Focal length/Internal temperature
warning °C/°FP. 146 | ㉚ AE lock.....P. 60, 115 |
| ⑪ Flash.....P. 64
(blinks: charging in progress, lights up:
charging completed) | ㉛ Shooting mode.....P. 24–53 |
| ⑫ AF confirmation mark.....P. 25 | ㉜ Touch operationP. 51 |
| ⑬ Picture mode.....P. 69, 99 | ㉝ Metering mode.....P. 80 |
| ⑭ ISO sensitivity.....P. 63 | ㉞ Sequential shooting/Self-timer.....P. 66 |
| ⑮ White balance.....P. 70 | Silent shootingP. 37 |
| ⑯ AF modeP. 72 | ㉟ Flash intensity control.....P. 77 |
| ⑰ Aspect ratio.....P. 73 | ㊱ Flash modeP. 64 |
| ⑱ Image quality (still images).....P. 73 | ㊲ Image stabilizer.....P. 78 |
| | ㊳ Battery levelP. 18 |
| | ㊴ Live guide recall.....P. 27 |

Monitor display during movie mode

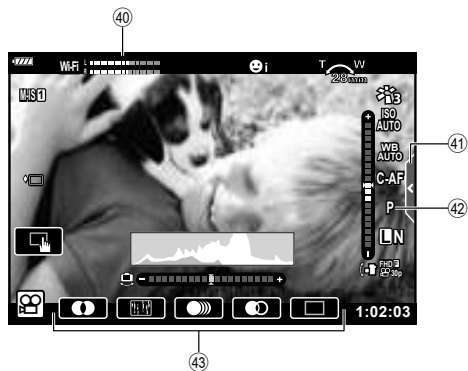

- ④① Recording level meter.....P. 102
- ④② Movie (exposure) mode.....P. 76
- ④③ Silent shooting tab.....P. 59
- ④④ Movie effectP. 54

Switching between displays

The camera is equipped with an eye sensor, which turns the viewfinder on when you put your eye to the viewfinder. When you take your eye away, the sensor turns the viewfinder off and turns the monitor on.



Monitor



View through lens shown in monitor



Put your
eye to the
viewfinder



Viewfinder



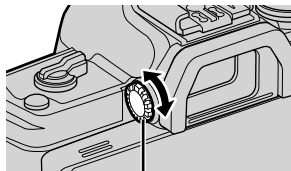

View through lens shown in viewfinder

- If the viewfinder is not in focus, put your eye to the viewfinder and focus the display by rotating the diopter adjustment dial.



Diopter adjustment dial

- You can display the EVF Auto Switch setting menu if you press and hold the  button.  [EVF Auto Switch] (P. 114)
- When [OFF] is selected for [EVF Auto Switch], you can switch displays by pressing the  button.

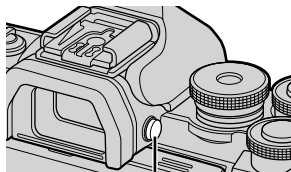

 button



Notes

- Tilting the monitor disables the eye sensor.

Switching the information display

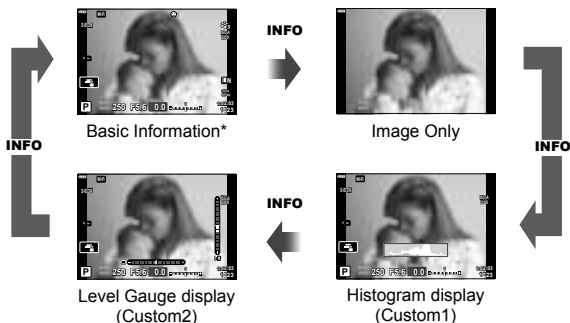
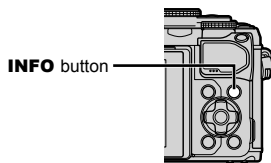
You can switch the information displayed in the monitor during shooting using the **INFO** button.



- * Not displayed in  mode (movie mode) unless recording is in progress.
- You can change Custom1 and Custom2 settings.  [Info Settings] > [LV-Info] (P. 110)
- The information display screens can be switched in either direction by rotating the dial while pressing the **INFO** button.

Histogram display

A histogram showing the distribution of brightness in the image is displayed. The horizontal axis gives the brightness, the vertical axis the number of pixels of each brightness in the image. During shooting, overexposure is indicated in red, underexposure in blue, and the range metered using spot metering in green.



Level gauge display

The orientation of the camera is indicated. The “tilt” direction is indicated on the vertical bar and the “horizon” direction on the horizontal bar. The camera is level and plumb when the bars turn green.

- Use the indicators on the level gauge as a guide.
- Error in the display can be corrected via calibration (P. 114).

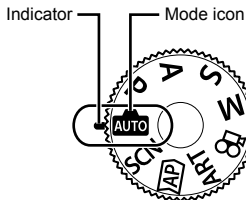

Shooting still pictures

Use the mode dial to select the shooting mode, and then shoot the image.



■ Types of shooting modes

For how to use the various shooting modes, see the following.

Shooting mode	Description	▶
	The camera automatically selects the most appropriate shooting mode.	27
SCN	The camera automatically optimizes settings for the subject or scene.	29
	Use for quick access to advanced shooting settings.	32
ART	You can shoot with the effect of artistic expression added.	42
P	The camera meters subject brightness and automatically adjusts shutter speed and aperture for optimal results.	45
A	You choose the aperture and the camera automatically adjusts shutter speed for optimal results.	46
S	You choose the shutter speed and the camera automatically adjusts aperture for optimal results.	47
M	You choose both the aperture and shutter speed.	48
	Shoot movies of various types.	53

Functions that cannot be selected from menus

Some items may not be selectable from the menus when using the arrow pad.

- Items that cannot be set with the current shooting mode.
- Items that cannot be set because of an item that has already been set:
Settings such as picture mode are unavailable when the mode dial is rotated to .

- 1 Rotate the mode dial to choose a mode.

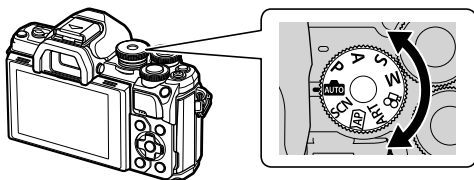

- 2 Frame the shot.

- Be careful that your fingers or the camera strap do not obstruct the lens or AF illuminator.



Landscape position

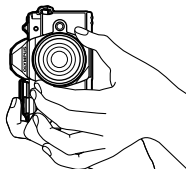

Portrait position

- 3 Adjust the focus.

- Display the subject in the center of the monitor, and lightly press the shutter button down to the first position (press the shutter button halfway). The AF confirmation mark (●) will be displayed, and a green frame (AF target) will be displayed in the focus location.

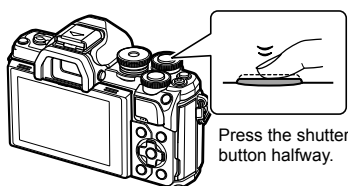

Press the shutter button halfway.



AF target

- If the AF confirmation mark blinks, the subject is not in focus. (P. 142)

- 4 Release the shutter.

- Press the shutter button all the way (fully).
- The camera will release the shutter and take a picture.
- The shot image will be displayed on the monitor.

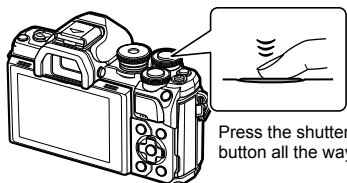

Press the shutter button all the way.

Notes

- You can focus and take pictures using touch controls.  "Shooting with touch screen operations" (P. 51)
- To exit to shooting mode from menus or playback, press the shutter button halfway.

Switching Displays with the (Shortcut) Button

Press the  button to switch to each screen of the selected shooting mode between shots.

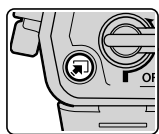

 (Shortcut) button

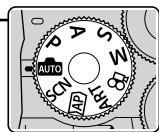
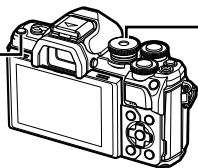

Mode dial



Live guide (P. 27)

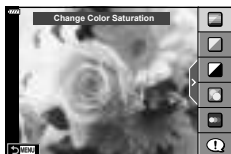

Scene mode (P. 29)



Advanced photo mode (P. 32)



Art filter mode (P. 42)



LV super control panel (P. 68)



Movie mode (P. 53)

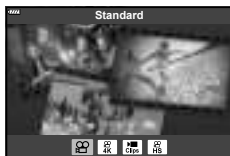

Letting the camera choose the settings (AUTO mode)

The camera adjusts settings to suit the scene; all you have to do is press the shutter button. Set the mode dial to **AUTO**.

Using live guides

Use live guides to easily adjust such parameters as color, brightness, and background blurring.

1 Press the  button to display live guides.

- Use Δ ∇ to highlight an item in the live guide and press **OK** to display a slider.



Guide item

2 Use Δ ∇ to position the slider and choose a level.

- Press the **OK** button to save changes.
- To exit, press the **MENU** button.
- When [Shooting Tips] is selected, use Δ ∇ to highlight the item and press the **OK** button to display the detail.

- The effect of the selected level is visible in the display.
If [Blur Background] or [Express Motions] is selected, the display will return to normal, but the selected effect will be visible in the final photograph.



Slider

3 To set multiple live guides, repeat Steps 1 and 2.

- A check is displayed on the guide item for live guides that are already set.
- [Blur Background] and [Express Motions] cannot be set at the same time.



4 Shoot.

- To clear the live guides from the display, press the **MENU** button.

- If [RAW] is currently selected for image quality, image quality will automatically be set to [L+N+RAW].
- Live guide settings are not applied to the RAW copy.
- Pictures may appear grainy at some live guide setting levels.
- Changes to live guide setting levels may not be visible in the monitor.
- Frame rates drop when [Blurred Motion] is selected.
- The flash cannot be used when a live guide is set.
- Choosing live guide settings that exceed the limits of the camera exposure meters may result in pictures that are overexposed or underexposed.

**Notes**

- Touch controls can also be used.

Shooting in scene mode (SCN mode)

The camera automatically optimizes settings for the subject or scene.

- 1 Rotate the mode dial to **SCN**.

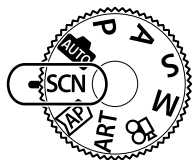

- 2 Use Δ ∇ \triangleleft \triangleright to highlight a scene and press the OK button.



- 3 Use \triangleleft \triangleright to highlight a scene mode and press the OK button.
 - Press the Fn button to choose a different scene.

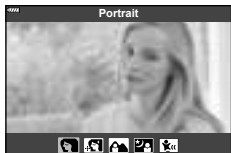

















- 4 Shoot.











Notes



- Touch controls can also be used.

■ Types of scene modes

Subject type	Scene mode	Description
People	 Portrait	Suitable for portrait shooting. Brings out skin texture.
	 e-Portrait	Smooths out skin tones and texture. This mode is suitable when viewing images on a high-definition TV. The camera records two pictures: one with the effect applied and one without.
	 Portrait + Landscape	Suitable for portraits featuring a landscape in the background. Blues, greens, and skin tones are captured beautifully.
	 Portrait + Nightscape	Suitable for portrait shooting against a background of night view. Use of a tripod and remote control via OI.Share is recommended (P. 122).
	 Children	Suitable for photographs of children and other active subjects.

Subject type	Scene mode	Description
Nightscapes	 Nightscape	Suitable for tripod shooting of night scenes. Use of a tripod and remote control via OI.Share is recommended (P. 122).
	 Portrait + Nightscape	Suitable for portrait shooting against a background of night view. Raise the flash (P. 64). Use of a tripod and remote control via OI.Share is recommended (P. 122).
	 Handheld Starlight	Suitable for shooting night scenes without a tripod. Reduces blur when shooting low light/illuminated scenes. The camera makes eight exposures and combines them into a single photograph.
	 Fireworks	Suitable for shooting fireworks at night. Use of a tripod and remote control via OI.Share is recommended (P. 122).
	 Light Trails	The camera automatically shoots multiple images, takes newly bright areas only, and composites them into a single image. With normal long exposure, an image of light trace such as star trails with bright buildings tends to get too bright. You can capture them without over exposure while checking the progress. Press the shutter button to start shooting, then view the changing result in the monitor and press the shutter button again to end shooting once the desired result is achieved (maximum 3 hours). Use of a tripod and remote control via OI.Share is recommended (P. 122). • Advanced settings can be accessed via live composite photography (dark and light field composite) in M mode (P. 50).
Motion	 Sport	Suitable for fast action shooting. The camera will take photos while the shutter button is pressed.
	 Children	Suitable for photographs of children and other active subjects.
	 Panning	Choose to blur the background behind moving objects. The camera chooses the optimal shutter speed for panning shots based on camera motion.
Scenery	 Landscape	Suitable for landscape shooting.
	 Sunset	Suitable for shooting the sunset.
	 Beach & Snow	Suitable for shooting at snow-capped mountains, seascapes in the sun, and other whitish scenes.
	 Backlight HDR	Suitable for contrasting scenes. This mode captures multiple images and merges them into one, properly exposed image (P. 36).

Subject type	Scene mode	Description
Indoors	 Candlelight	Suitable for shots of candlelit scenes. Warm colors are preserved.
	 Silent 	Disable camera sounds and lights in situations in which they may be unwelcome (P. 37).
	 Portrait	Suitable for portrait shooting. Brings out skin texture.
	 e-Portrait	Smooths out skin tones and texture. This mode is suitable when viewing images on a high-definition TV. The camera records two pictures: one with the effect applied and one without.
	 Children	Suitable for photographs of children and other active subjects.
	 Backlight HDR	Suitable for contrasting scenes. This mode captures multiple images and merges them into one, properly exposed image (P. 36).
Close-ups	 Macro	Suitable for close-ups.
	 Nature Macro	Suitable for vivid close-ups of flowers or insects.
	 Documents	Suitable for photos of timetables or other documents. The camera heightens the contrast between the text and background.
	 Multi Focus Shot	The camera takes eight photos, varying the focus distance with each shot (P. 41).

- To maximize the benefits of the scene modes, some of the shooting function settings are disabled.
- Some time may be needed to record pictures taken using [e-Portrait]. In addition, when the image quality mode is [RAW], the image is recorded in RAW+JPEG.
- Movies cannot be recorded using [e-Portrait], [Handheld Starlight], or [Backlight HDR].
- [Handheld Starlight] pictures taken with [RAW] selected for image quality will be recorded in RAW+JPEG format, with the first frame recorded as a RAW image and the final composite as a JPEG image.
- [Backlight HDR] records HDR-processed images in JPEG format. When the image quality mode is set to [RAW], the image is recorded in RAW+JPEG.
- In [Panning],  is displayed during panning detection, and  is displayed when nothing is detected.
- When using a lens with an image stabilizer switch in [Panning], turn the image stabilizer switch off.
Sufficient panning effects may not be obtained in bright conditions. Use a commercially available ND filter to obtain effects more easily.

Shooting in advanced photo mode (AP mode)

Use for quick access to advanced shooting settings.

- 1 Rotate the mode dial to **AP**.

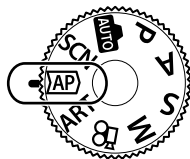

- 2 Use **<>** to highlight an AP mode.
 - Some modes offer additional options that can be accessed using **∇**.













- 3 Press the **OK** button to select the highlighted mode.
 - Press the **↶** button to choose a different mode. If additional options are displayed, press **△**.

Notes

- In some modes, the front dial can be used for exposure compensation (P. 60) and the rear dial for program shift (P. 45).
- Touch controls can also be used.

■ AP Mode Options

AP mode	Description	
 Live Composite	Record light trails from stars and other objects while keeping exposure constant overall.	33
 Live Time	Choose for photos of fireworks and night scenery. Make long time exposures at selected shutter speeds.	34
 Multiple Exposure	Combine two different images on top of one another.	35
 HDR	Capture details in both highlights and shadows.	36
 Silent [v]	Disable camera sounds and lights in situations in which they may be unwelcome.	37
 Panorama	Take photos that can afterwards be joined on a computer to create a panorama.	38
 Keystone Compensation	Correct the effects of perspective in photos of buildings or landscapes.	39
 AE Bracketing	Each time the shutter button is pressed, the camera takes a series of photos, varying exposure with each shot.	40
 Focus Bracketing	Each time the shutter button is pressed, the camera takes a series of eight photos, varying the focus distance with each shot.	41

■ [Live Composite]: Live Composite Photography

Create photos that record light trails from stars and other objects without changing the brightness of the background; during shooting, the changing results can be viewed in the monitor. You can adjust white balance or picture mode and other settings not available with the **SCN** mode "Light Trails" option.

- 1 Highlight [Live Composite] in the AP mode menu (P. 32) and press the  button.
- 2 Press the shutter button halfway down to focus.
 - To reduce blur caused by camera shake, fix the camera securely to a tripod and use a remote shutter release controlled via OI.Share (P. 122) in wireless remote mode.
 - If the focus indicator blinks, the camera is not in focus.
- 3 Press the shutter button all the way down to shoot.
 - The camera configures the proper settings automatically and starts shooting.
 - After pressing the shutter button, there is a time lag until shooting starts.
 - The composite image will be displayed at regular intervals.
- 4 Press the shutter button again to stop shooting.
 - View the changing result in the monitor and press the shutter button to end shooting once the desired result is achieved.
 - The recording length in one shooting is up to 3 hours.



Notes

- Advanced settings can be accessed via live composite photography (dark and light field composite) in **M** mode (P. 50).

■ [Live Time]: Live Time Photography

You can make long exposures without having to keep the shutter button pressed. The changing result can be viewed in the monitor during shooting.

1 Highlight [Live Time] in the AP mode menu (P. 32).

2 Press ∇ , use $\triangleleft \triangleright$ to choose the maximum exposure time, and press the \odot button.

- The display refresh rate may change automatically depending on the maximum exposure time selected.
- The shorter the maximum exposure time, the faster the display refresh rate.



3 Press the shutter button halfway down to focus.

- To reduce blur caused by camera shake, fix the camera securely to a tripod and use a remote shutter release controlled via OI.Share (P. 122) in wireless remote mode.
- If the focus indicator blinks, the camera is not in focus.

4 Press the shutter button all the way down to start live time photography.

- The camera adjusts settings automatically and begins shooting.
- The changing result can be viewed in the monitor.

5 Press the shutter button again to stop shooting.

- View the changing result in the monitor and press the shutter button to end shooting once the desired result is achieved.
- Shooting ends automatically when the selected exposure time is reached.







Notes

- The long exposure (bulb/time) options in **M** mode offer more advanced settings (P. 49).

■ [Multiple Exposure]: Shooting Multiple Exposures

Combine two different images on top of one another.

- 1 Highlight [Multiple Exposure] in the AP mode menu (P. 32) and press the  button.
- 2 Press the shutter button halfway down to focus.
 - If the focus indicator blinks, the camera is not in focus.
- 3 Press the shutter button all the way down for the first shot.
 -  is displayed in green if shooting starts.
 - The image is shown superimposed on the monitor.
 - Press  to delete the last shot.
- 4 Take the second shot.
 - Use the first image as a guide to compose the second shot.
 - The camera will not go to sleep while multiple exposure is in effect.
 - Performing any of the following actions automatically deletes the second shot:
The camera is turned off, the  button is pressed, the **MENU** button is pressed, pressing the  button, rotating the mode dial, the battery power runs out, or any cable is connected to the camera.



Tips

- For more information on creating image overlays:  "Image overlay" (P. 105)

■ [HDR]: Taking Composite Photos with HDR

Capture details in both highlights and shadows. The camera varies exposure over a series of four shots and combines them into a single image.

- 1 Highlight [HDR] in the AP mode menu (P. 32).
- 2 Press ∇ , use $\triangleleft \triangleright$ to choose [HDR1] or [HDR2], and press the \odot button.

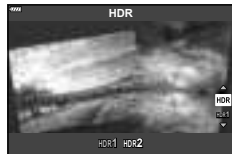

HDR1	Four shots are taken, each with a different exposure, and the shots are combined into one HDR image inside the camera. HDR2 provides a more impressive image than HDR1. ISO sensitivity is fixed to 200.
HDR2	



- 3 Press the shutter button halfway down to focus.
 - If the focus indicator blinks, the camera is not in focus.
- 4 Press the shutter button all the way down to start HDR photography.
 - The camera automatically takes four shots when the shutter button is pressed.
 - Noise may be more noticeable in photos taken in conditions associated with slow shutter speeds.
 - For best results, secure the camera by, for example, mounting it on a tripod.
 - The image displayed on the monitor or in the viewfinder while shooting will differ from the HDR-processed image.
 - The HDR-processed image will be saved as a JPEG file. When the image quality mode is set to [RAW], the image is recorded in RAW+JPEG.
 - The picture mode is fixed to [Natural] and the color space is fixed to [sRGB].

■ [Silent [♥]] Mode

Disable camera sounds and lights in situations in which they may be unwelcome.

- 1 Highlight [Silent [♥]] in the AP mode menu (P. 32) and press the  button.
- 2 Press the shutter button halfway down to focus.
 - If the focus indicator blinks, the camera is not in focus.
- 3 Press the shutter button all the way down to shoot.
 - When the shutter is released, the monitor screen will go dark for a moment. No shutter sound will be emitted.
 - The desired results may not be achieved under flickering light sources such as fluorescent or LED lamps or if the subject moves abruptly during shooting.
 - In [Silent [♥]] mode, the following measures are undertaken to reduce the sound and light produced by the camera.
 - Electronic shutter: Enabled
 - ): Off
 - AF Illuminator: Off
 - Flash mode: Off
 - Note that due to the electronic shutter, the subject may appear to be distorted in photographs if camera moves quickly during shooting or when shooting fast-moving subjects.
 - Long exposure noise reduction is not available in [Silent [♥]] mode.







Notes

- Press  for sequential/self-timer photography (P. 66).

■ [Panorama]: Taking Pictures for a Panorama

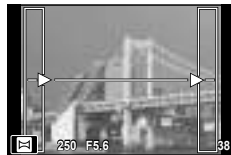

Pictures taken using this option can be joined together to form a panorama. You will need to install the latest version of OLYMPUS Viewer 3 on your computer to join pictures together to form a panorama.  "Connecting the camera to a computer and a printer" (P. 125)

- 1 Highlight [Panorama] in the AP mode menu (P. 32) and press the  button.
- 2 Use     to choose a pan direction.
- 3 Take a picture, using the guides to frame the shot.
 - Focus, exposure, and other settings are fixed at the values for the first shot.

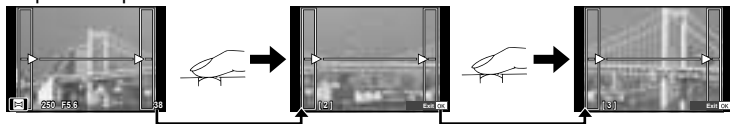

- 4 Take the remaining images, framing each shot so that the guides overlap with the previous picture.



- A panorama may include up to 10 images. A warning indicator () is displayed after the tenth shot.
 - During panorama shooting, the image previously taken for position alignment will not be displayed. With the frames or other markers for display in the images as a guide, set the composition such that the edges of the overlapping images overlap within the frames.
- 5 After taking the last shot, press  to end the series.

■ [Keystone Compensation]

Correct the effects of perspective in photos of buildings or landscapes.

1 Highlight [Keystone Compensation] in the AP mode menu (P. 32) and press the **OK** button.

2 Adjust the effect in the display and frame the shot.

- Use the front dial and rear dial for keystone correction.
- Use **△ ▽ <|>** to choose the area to be recorded. The area cannot be changed depending on the amount of correction.
- Press and hold the **OK** button to cancel any changes.
- To adjust exposure compensation and other shooting options while keystone compensation is in effect, press the **INFO** button to view a display other than keystone compensation adjustment. To resume keystone compensation, press the **INFO** button until keystone compensation adjustment is displayed.
- The following may occur as the correction amount increases.
 - The image will be coarse.
 - The magnification ratio for image cropping will be large.
 - The crop position will not be able to move.

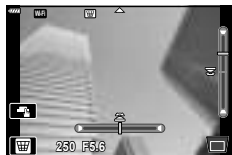

3 Press the shutter button halfway down to focus.

- If the focus indicator blinks, the camera is not in focus.

4 Press the shutter button all the way down to shoot.

- Photos are recorded in RAW+JPEG format when [RAW] is selected for image quality.
- The desired results may not be obtained with converter lenses.
- Depending on the amount of correction, some AF targets may be outside the display area. An icon (**⊕**, **⊖**, **←** or **→**) is displayed when the camera focuses on an AF target outside the display area.
- If a focus distance is selected for [Image Stabilizer], the correction will be adjusted for the selected focus distance. Except when using a Micro Four Thirds or Four Thirds lens, choose a focal length using the [Image Stabilizer] option (P. 78).

■ [AE Bracketing]: Varying Exposure over a Series of Shots

Take a series of photos, varying exposure with each shot.

- 1 Highlight [AE Bracketing] in the AP mode menu (P. 32).
- 2 Press ∇ , use $\triangleleft \triangleright$ to choose the number of shots, and press the \odot button.

3f	Take 3 shots, the first at optimal exposure (± 0.0 EV), the second at -1.0 EV, and the third at $+1.0$ EV.
5f	Take 5 shots, the first at optimal exposure (± 0.0 EV), the second at -1.3 EV, the third at -0.7 EV, the fourth at $+0.7$ EV, and the fifth at $+1.3$ EV.



- 3 Press the shutter button halfway down to focus.
 - If the focus indicator blinks, the camera is not in focus.
- 4 Press the shutter button all the way down to shoot.
 - Take the set number of shots.
 - The BKT indicator turns green during bracketing.
 - The camera brackets the value currently selected for exposure compensation.

■ [Focus Bracketing]: Varying Focus Distance over a Series of Shots

Each time the shutter button is pressed, the camera takes a series of eight photos, varying the focus distance with each shot.

- 1 Highlight [Focus Bracketing] in the AP mode menu (P. 32).
- 2 Press ∇ , use $\triangleleft \triangleright$ to choose the amount focus distance changes with each shot, and press the OK button.



	The focus distance changes by a small amount with each shot.
	The focus distance changes by a large amount with each shot.

- 3 Press the shutter button halfway down to focus.
 - If the focus indicator blinks, the camera is not in focus.
- 4 Press the shutter button all the way down to shoot.
 - The camera takes eight photos, varying the focus distance with each shot. The camera will take pictures at, and at distances in front of and behind, the focus distance chosen when the shutter button is pressed halfway.
 - The BKT indicator turns green during bracketing.
 - Focus bracketing ends if zoom is adjusted during shooting.
 - Shooting ends when focus reaches infinity.
 - Focus bracketing uses the electronic shutter.
 - Focus bracketing is not available with lenses that have mounts conforming to the Four-Thirds or some Micro Four-Thirds standards.

Using art filters (ART mode)

Using art filters, you can easily have fun with artistic effects.

- 1 Rotate the mode dial to **ART**.

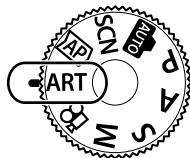

- 2 Use $\triangleleft \triangleright$ to highlight a filter.



- 3 Press ∇ , highlight an effect using $\triangleleft \triangleright$, and press the \odot button.

- Press the \blacksquare button to choose a different art filter. If effects are displayed, press \triangle .
- The effects available vary with the selected filter (Soft Focus Effect, Pin Hole Effect, Frame Effect, White Edge Effect, Star Light Effect, Color Filter, Monochrome Color, Blur Effect, or Shade Effect).



- 4 Shoot.

Notes

- [Color Filter] (P. 82) and [Monochrome Color] (P. 83) options are available with some art filters.
- The front dial can be used for exposure compensation (P. 60).
- The rear dial can be used for program shift (P. 45).
- Touch controls can also be used.

■ Types of art filters

Pop Art I/II	Creates an image that emphasizes the beauty of color.
Soft Focus	Creates an image that expresses a soft tone atmosphere.
Pale&Light Color I/II	Creates an image that expresses warm light by scattering overall light and slightly overexposing the image.
Light Tone	Creates a high-quality image by softening both shadows and highlights.
Grainy Film I/II	Creates an image that expresses the roughness of black and white images.
Pin Hole I/II/III	Creates an image that looks as if it was taken using an old or toy camera by dimming the image perimeter.
Diorama I/II	Creates a miniature-like image by emphasizing saturation and contrast, and blurring unfocused areas.
Cross Process I/II	Creates an image that expresses a surreal atmosphere. Cross Process II creates an image that emphasizes magenta.
Gentle Sepia	Creates a high-quality image by drawing out shadows and softening the overall image.
Dramatic Tone I/II	Creates an image that emphasizes the difference between brightness and darkness by partially increasing contrast.
Key Line I/II	Creates an image that emphasizes edges and adds an illustrative style.
Watercolor I/II	Creates a soft, bright image by removing dark areas, blending pale colors on a white canvas, and further softening contours.
Vintage I/II/III	Expresses an everyday shot in a nostalgic, vintage tone using printed film discoloration and fading.
Partial Color I/II/III	Impressively expresses a subject by extracting colors you want to emphasize and keeping everything else monotone.
Bleach Bypass I/II	The “bleach bypass” effect, which you may recognize from motion pictures and the like, can be used to great effect in shots of streetscapes or metal objects.

II and III are altered versions of the original (I).

- To maximize the benefits of the art filters, some of the shooting function settings are disabled.
- If [RAW] is currently selected for image quality (P. 73), image quality will automatically be set to [L/N+RAW]. The art filter will be applied to the JPEG copy only.
- Depending on the subject, tone transitions may be ragged, the effect may be less noticeable, or the image may become more “grainy.”
- Some effects may not be visible in live view or during movie recording.
- Your choice of filters, effects, and movie quality when recording movies may affect playback speed and smoothness.

■ Using [Partial Color]

Record only selected hues in color.

- 1 Select [Partial Color I/II/III] in the art filter menu (P. 42).
- 2 Highlight an effect and press the **OK** button.
 - A color ring appears in the display.
- 3 Rotate the front dial or rear dial to select a color.
 - The effect is visible in the display.
- 4 Shoot.
 - If you want to change the extracted color after shooting, rotate the front dial (**⊕**) or rear dial (**⊖**) to display the color ring.



Letting the camera choose aperture and shutter speed (Program mode)

P mode is a shooting mode where the camera automatically sets the optimal aperture and shutter speed according to subject brightness. Set the mode dial to **P**.

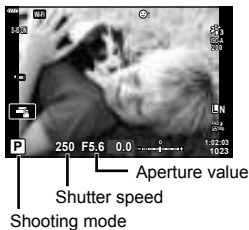
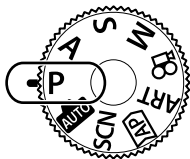

- The shutter speed and aperture selected by the camera are displayed.
- You can use the front dial to select exposure compensation.
- You can use the rear dial to select program shift.
- The shutter speed and aperture value displays will blink if the camera is unable to achieve correct exposure.

The aperture value at the moment when its indication blinks varies with the lens type and focal length of the lens.

When using a fixed [ISO] setting, change the setting. "Changing ISO sensitivity (ISO)" (P. 63)

Warning display example (blinking)	Status	Action
	The subject is too dark.	<ul style="list-style-type: none"> • Use the flash.
	The subject is too bright.	<ul style="list-style-type: none"> • The metered range of the camera is exceeded. A commercially available ND filter (for adjusting the amount of light) is required.

Program shift (Ps)

In **P** mode, **ART** mode, and some **AP** modes, you can choose other combinations of aperture and shutter speed that will produce the same exposure. Turn the rear dial to program shift so that "s" appears next to the shooting mode. To cancel program shift, turn the rear dial until "s" is no longer displayed.

- Program shift is not available in other modes or when the flash is used.



Choosing aperture (Aperture Priority mode)

A mode is a shooting mode where you choose the aperture and let the camera automatically adjust to the appropriate shutter speed. Rotate the mode dial to **A** and then use the rear dial to select an aperture value.

Larger apertures (lower F-numbers) decrease depth of field (the area in front of or behind the focus point that appears to be in focus), softening background details. Smaller apertures (higher F-numbers) increase depth of field.

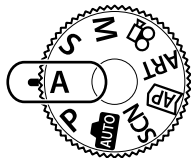

Aperture value

- You can use the front dial to select exposure compensation.

Setting the aperture value

Decreasing aperture value ← → Increasing aperture value

F2.8 ← F4.0 ← **F5.6** → F8.0 → F11

(Decreasing depth of field) ← → (Increasing depth of field)

- The shutter speed display will blink if the camera is unable to achieve correct exposure.
- When using a fixed [ISO] setting, change the setting. "Changing ISO sensitivity (ISO)" (P. 63)

Warning display example (blinking)	Status	Action
	The subject is underexposed.	<ul style="list-style-type: none"> Decrease the aperture value.
	The subject is overexposed.	<ul style="list-style-type: none"> Increase the aperture value. If the warning display does not disappear, the metered range of the camera is exceeded. A commercially available ND filter (for adjusting the amount of light) is required.

Choosing shutter speed (Shutter Priority mode)

S mode is a shooting mode where you choose the shutter speed and let the camera automatically adjust to the appropriate aperture value. Rotate the mode dial to **S** and then use the rear dial to select shutter speed.

Fast shutter speeds freeze motion of fast-moving subjects. Slow shutter speeds add motion by blurring moving subjects.

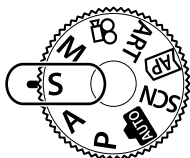

Shutter speed

- You can use the front dial to select exposure compensation.

Setting the shutter speed

Slower shutter speed ← → Faster shutter speed

60" ← 15 ← 30 ← **60** → 125 → 250 → 4000

(Add motion) ← → (Freeze motion)

- The aperture value display will blink if the camera is unable to achieve correct exposure.
- The aperture value at the moment when its indication blinks varies with the lens type and focal length of the lens.
- When using a fixed [ISO] setting, change the setting. "Changing ISO sensitivity (ISO)" (P. 63)

Warning display example (blinking)	Status	Action
	The subject is underexposed.	<ul style="list-style-type: none"> Set the shutter speed slower.
	The subject is overexposed.	<ul style="list-style-type: none"> Set the shutter speed faster. If the warning display does not disappear, the metered range of the camera is exceeded. A commercially available ND filter (for adjusting the amount of light) is required.

Choosing aperture and shutter speed (Manual mode)

M mode is a shooting mode where you choose both the aperture value and shutter speed. Bulb, time, and live composite photography are also available. Rotate the mode dial to **M**, and then use the front dial to select aperture value and the rear dial to select shutter speed.

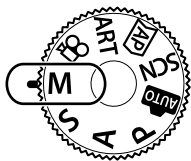

Difference from correct exposure

- The exposure determined by the aperture value and shutter speed you have set and the difference from the suitable exposure measured by the camera are displayed on the monitor.
- Shutter speed can be set to values between 1/4000 and 60 seconds or to [BULB], [LIVE TIME], or [LIVECOMP].
- The brightness of the image displayed in the monitor (or viewfinder) will change with changes in aperture and shutter speed. You can fix the brightness of the display so that you can keep the subject in view while shooting.  [Live View Boost] (P. 110)
- Even when you have set [Noise Reduct.], noise and/or light spots may still be noticeable in the image displayed on the monitor and shot images under certain environmental conditions (temperature etc.) and camera settings.

Noise in images

While shooting at slow shutter speeds, noise may appear on screen. These phenomena occur when the temperature rises in the image pickup device or image pickup device internal drive circuit, causing current to be generated in those sections of the image pickup device that are not normally exposed to light. This can also occur when shooting with a high ISO setting in a high-temperature environment. To reduce this noise, the camera activates the noise reduction function.  [Noise Reduct.] (P. 111)

Shooting with long exposure time (BULB/LIVE TIME)

Use for photos such as fireworks or night scenery. In **M** mode, rotate the rear dial in the direction shown until [BULB] or [LIVE TIME] is displayed in the monitor.

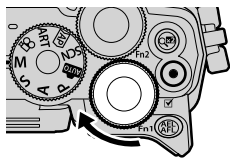

Bulb photography (BULB):

The shutter remains open while the shutter button is pressed. The exposure ends when the shutter button is released. The view through the lens is not displayed while exposure is in progress.

Time photography (LIVE TIME):

The exposure begins when the shutter button is pressed all the way down. To end the exposure, press the shutter button all the way down again. The view through the lens is displayed while exposure is in progress.

- To display the view through the lens in the monitor during bulb photography, select an option other than [Off] for [Live Bulb].
- Press the **MENU** button to choose the display interval for [Live Bulb] or [Live Time] photography. Select [Off] to disable the display while exposure is in progress.
- To refresh the display while exposure is in progress, tap the monitor or press the shutter button halfway.
- [BULB] and [LIVE TIME] are not available at some ISO sensitivity settings.
- To reduce blur caused by camera shake, fix the camera securely to a tripod and use a remote shutter release controlled via OI.Share (P. 122).
- During shooting, there are limits on the settings for the following functions.
Sequential shooting, self-timer shooting, time lapse shooting, image stabilizer, etc.

Live composite photography (dark and light field composite)

Combine several exposures to create a photo that records light trails from stars or fireworks and other objects without changing the brightness of the background.

- 1 In **M** mode, set the shutter speed to [LIVECOMP].
 - In **M** mode, rotate the rear dial in the direction shown until [LIVECOMP] is displayed in the monitor.

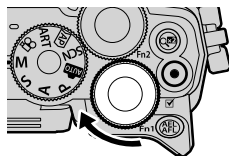



- 2 Press the **MENU** button to display [Composite Settings] and press $\Delta \nabla$ to choose the exposure time for the individual exposures.
 - 3 Press the shutter button to ready the camera.
 - The camera will shoot a frame as a reference for noise reduction.
 - The camera is ready when [Ready for composite shooting] is displayed in the monitor.
 - 4 Press the shutter button halfway down to focus.
 - If the focus indicator blinks, the camera is not in focus.
 - 5 Press the shutter button all the way down to start live composite photography.
 - The combined image will be displayed in the monitor with each exposure.
 - 6 Press the shutter button again to stop shooting.
 - View the changing result in the monitor and press the shutter button to end shooting once the desired result is achieved.
 - The maximum length of composite shooting is 3 hours. However, the available shooting time will vary depending on shooting conditions, and charging state of the camera.
- There are limits on the available ISO sensitivity settings.
 - To reduce blur caused by camera shake, fix the camera securely to a tripod and use a remote shutter release controlled via OI.Share (P. 122).
 - During shooting, there are limits on the settings for the following functions.
 - Sequential shooting, self-timer shooting, time lapse shooting, image stabilizer, etc.

Shooting with touch screen operations

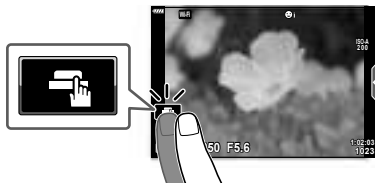
Tap  to cycle through touch screen settings.





	Tap a subject to focus and automatically release the shutter. This feature is not available in movie mode and during bulb, time, or composite photography.
	Touch screen operations are disabled.
	Tap to display an AF target and focus on the subject in the selected area. Photographs can be taken by pressing the shutter button.

■ Previewing the subject ()

- 1 Tap the subject in the display.
 - An AF target will be displayed.
 - Use the slider to choose the size of the frame.
 - Tap  to turn off the display of the AF target.



- 2 Tap  to zoom in at the frame position.
 - Use your finger to scroll the display when the picture is zoomed in.
 - Tap  to cancel the zoom display.
 - You cannot resize or zoom in on the target in movie mode.

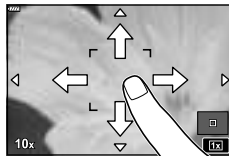

- The situations in which touch screen operations are not available include the following.
 - Panorama, one touch WB, while buttons or dials are in use, etc.
 - Do not touch the display with your fingernails or other sharp objects.
 - Gloves or monitor covers may interfere with touch screen operation.
 - You can disable the touch screen operation.  [Touchscreen Settings] (P. 114)

Recording movies

Recording movies in photo shooting modes

Use the  button to record movies.

1 Press the button to begin recording.

- Movie you are recording will be displayed on the monitor.
- If you put your eye to the viewfinder, movie you are recording will be displayed in the viewfinder.
- You can change the focus location by tapping the screen while recording.

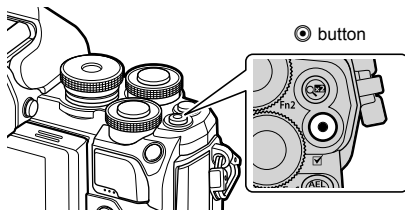

2 Press the button again to end recording.







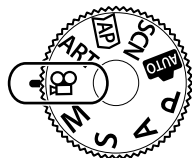

- When using a camera with a CMOS image sensor, moving objects may appear distorted due to the rolling shutter phenomenon. This is a physical phenomenon whereby distortion occurs in the filmed image when shooting a fast-moving subject or due to camera shaking. In particular, this phenomenon becomes more noticeable when using a long focal length.
- If the size of the movie file being recorded exceeds 4 GB, the file will be split automatically. (Depending on shooting conditions, movies under 4 GB in size may be split into multiple files.)
- When recording movies, use an SD card that supports an SD speed class of 10 or higher.
- If the camera is used for extended periods, the temperature of the image pickup device will rise and noise and colored fog may appear in images. Turn off the camera for a short time. Noise and colored fog may also appear in images recorded at high ISO sensitivity settings. If the temperature rises further, the camera will turn off automatically.
- When using a Four Thirds system lens, the AF will not operate while recording movies.
- The  button cannot be used to record movies in the following instances:
 - While shutter the button is pressed halfway; during bulb, time, composite, sequential or time lapse photography; or when e-portrait, handheld starlight, or backlight HDR is selected in **SCN** mode or keystone compensation, panorama, live time, multiple exposure, or HDR is selected in **AP** mode

Recording movies in movie mode

Movie mode can be used to create movies that take advantage of the effects available in photo shooting modes.

- 1 Rotate the mode dial to .







- 2 Use   to highlight movie mode.
 - Some modes offer additional options that can be accessed using .
- 3 Press the  button to select the highlighted mode.
 - Press the  button to choose a different movie mode. If additional options are displayed, press .
- 4 Press the  button to begin recording.
 - Press the  button again to end recording.



Notes

- Touch controls can also be used.

■ Movie Mode Options

Movie mode	Description	
 Standard	Shoot standard movies, or shoot movies with selected effects.	54
 4K	Shoot 4K movies.	—
 Clips	Create a single movie file including multiple short movies.	56
 High-speed	Record slow-motion movies. Sound will not be recorded.	59





- The picture mode art filter options are not available in [4K] mode.
- Use UHS-I or UHS-II memory card with a UHS Speed Class of 3 or better when shooting in [4K] mode.

■ Movie Effects

- 1 Highlight [Standard] in the movie mode option (P. 53) and press the **OK** button.
- 2 Press the **REC** button to begin recording.
- 3 Tap the on-screen icon of the effect you wish to use.
 - Tap the display to add effects during shooting.
 - Some effects can be added by tapping the display before starting recording.



Movie effect

Movie effect	Description
 Art Fade	Films with the selected picture mode effect. The fade effect is applied to the transition between scenes.
 Old Film	Randomly applies damage and dust-like noise similar to old movies.
 Multi Echo	Applies an after-image effect. After-images will appear behind moving objects.
 One Shot Echo	Applies an after-image for a short time after you tap the icon. The after-image will disappear automatically after a while.
 Movie Tele-converter	Zooms in on an area of the image without using the lens zoom. The selected position of the image can be zoomed in even while the camera is kept fixed.

- 4 Press the **REC** button again to end recording.
 - The **INFO** button also controls the display of shooting information during movie recording. Note, however, that pressing the **INFO** button during recording cancels all movie effects except movie tele-converter.

Art Fade

Tap the icon. The effect will be applied gradually when you tap the icon of a picture mode.

- Movies shot in partial color use the color selected in **ART** mode.

Old Film

Tap the icon for the effect to be applied. Tap again to cancel the effect.

Multi Echo

Tap the icon for the effect to be applied. Tap again to cancel the effect.

One Shot Echo

Each tap of the icon adds the effect.

Movie Tele-converter**1** Tap the icon to display the zoom frame.

- You can change the position of the zoom frame by tapping the screen or using Δ ∇ \triangleleft \triangleright .
- Press and hold the OK button to return the zoom frame to a central position.

**2** Tap LEF to zoom in on the area in the zoom frame.

- Tap C-AF to return to the zoom frame display.

3 Tap Off or press the OK button to cancel the zoom frame and exit Movie Tele-converter mode.

- The 2 effects cannot be applied simultaneously.
- Some effects may not be available depending on the picture mode.
- The sound of touch operations and button operations may be recorded.
- The frame rate may drop if an art filter or a movie effect is used.

■ Creating Movies from Clips

You can create a single movie file including multiple short movies (clips). Clips can be split into multiple groups ("My Clips"). You can also add still pictures to the My Clips movie.

Recording Clips

- 1 Highlight [Clips] in the movie mode option (P. 53).
- 2 Press ∇ , use $\triangleleft \triangleright$ to choose the clip length, and press the \odot button.
 - Three movie quality (frame size and rate) options are available via live controls (P. 75).
- 3 Press the \odot button to start shooting.
 - Shooting ends automatically when the selected recording time is reached.
 - If you press the \odot button during shooting, movie recording will continue for the length of time the button was pressed (maximum 16 seconds).
 - The new clip is added to My Clips.

\triangle	Plays back My Clips from the beginning.
∇	Changes My Clips to save the clip to and the position to add the clip to. Use $\triangleleft \triangleright$ to change the position to add the clip to in the My Clips.
\odot	Prepare to record the next clip.
trash	Deletes the shot clip.



- 4 Press the \odot button to shoot the next clip.
 - The confirmation screen will disappear and shooting of the next clip will start.
 - The new clip is added to the same My Clips group as the previous clip.
 - Movies recorded at different frame sizes or rates are saved to different My Clips groups.

Creating new My Clips

Press ∇ in Step 3.

Use $\triangle \nabla$ to move the clip to trash and press the \odot button.

Removing a clip from My Clips

Press ∇ in Step 3.





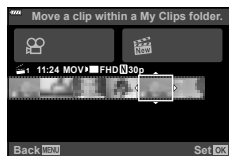

Move a clip to trash using $\triangle \nabla \triangleleft \triangleright$, and press the \odot button.

- The clip removed from My Clips will be a normal movie file.



Playback

You can play back the files in My Clips consecutively.

- 1 Press the  button and select an image marked .
- 2 Press the  button and select [Play My Clips] using . Then press the  button again.
 - The files in My Clips will play back consecutively.
 - Press the  button to end the consecutive playback.







Editing "My Clips"

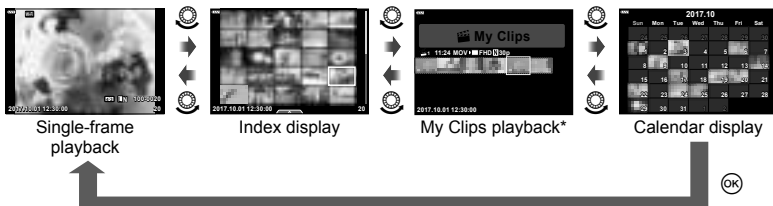

You can create a single movie file from My Clips.



The shot clips are stored in My Clips. You can add movie clips and still pictures to My Clips (P. 95). You can also add screen transition effects and art filter effects.

- 1 Press the  button and then rotate the rear dial to play back My Clips.



* After pressing the  button, you can also view the My Clips playback display by highlighting an item marked with , pressing the  button, and selecting [See all My Clips] from the menu that appears.

- 2 Use  to select My Clips and  to select a clip, and press the  button.
 - The clip menu will be displayed.

Play My Clips	Plays back the files in My Clips in order, starting from the beginning.
Play Movie	Plays back the selected clips as movie.
Export My Clips	Exports the files in My Clips as a movie file.
Rearrange Order	Moves or adds files in My Clips.
Preset Destination	From the next time you shoot, movies shot in the same settings will be added to this  My Clips.
Delete My Clips	Deletes all unprotected files from My Clips.
Erase	Select [Yes] and press the  button to delete the clip.

- 3** With the My Clips you want for the movie selected, highlight [Export My Clips] and press the **OK** button.
- 4** Select an item using **△**/**▽** and press the **OK** button.

Clip Effects	You can apply 6 types of art effects.
Transition Effect	You can apply fade effects.
BGM	You can set [Happy Days] or [Off].
Recorded Clip Volume	When [BGM] is set to [Happy Days], you can set a volume for sounds recorded in the movie.
Recorded Clip Sound	By setting to [On], you can create a movie with the recorded sound. This setting is only available when [BGM] is set to [Off].
Preview	You can preview the files of the edited My Clips in order, starting from the first file.

- 5** When you have finished the editing, select [Begin Export] and press the **OK** button.
- The combined album is saved as a single movie.
 - Exporting a movie may take some time.
 - The maximum length for My Clips is 15 minutes and the maximum file size is 4 GB.
- It may take a while for My Clips to display after taking out, inserting, erasing, or protecting the card.
 - You can record a maximum of 99 My Clips and a maximum of 99 cuts per clip. The maximum values may vary depending on the file size and length of My Clips.
 - You cannot add movies other than clips to My Clips.

BGM other than [Happy Days]

To use BGM other than [Happy Days], record data that you have downloaded from the Olympus website onto the card and select it as [BGM] in Step 4. Visit the following website for the download.

<http://support.olympus-imaging.com/bgmdownload/>

■ [Hi-Speed]: Recording Slow Motion Movies

Record slow-motion movies. Footage shot at 120 fps plays back at 30 fps; quality is equivalent to [HD].

- 1 Highlight [Hi-Speed] in the movie mode option (P. 53) and press the **OK** button.
- 2 Press the **DISP** button to start shooting.
 - Press the **DISP** button again to end shooting.
 - Focus and exposure are fixed at the start of recording.
 - Recording can continue for up to 20 seconds.
 - Sound will not be recorded.

Using the silencing function when shooting a movie

You can prevent the camera from recording operating sounds that occur due to camera operations while shooting.

Tap the silent shooting tab to display the function items. After tapping an item, tap the displayed arrows to select the settings.

- Electronic zoom*, recording volume, aperture, shutter speed, exposure compensation, ISO sensitivity
 - * Only available with power zoom lenses
- The options available vary with the shooting mode.

Silent shooting tab



Using various settings

Controlling exposure (Exposure)

Rotate the front dial to choose exposure compensation. Choose positive (“+”) values to make pictures brighter, negative (“-”) values to make pictures darker. Exposure can be adjusted by ± 5.0 EV.

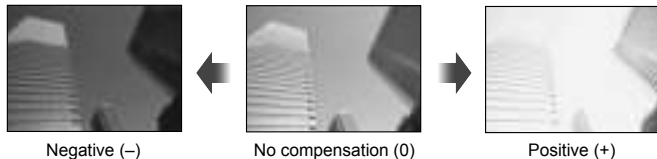

- Exposure compensation is not available in **Auto**, **M**, or **SCN** mode or when Live Time or panorama is selected in **AP** mode.
- Only values of up to ± 3 EV are reflected in the live view display in the monitor or viewfinder. If the exposure exceeds ± 3.0 EV, the exposure bar will begin flashing.
- Movies can be corrected in a range up to ± 3.0 EV.

Locking the exposure (AE Lock)

You can lock the exposure by pressing the **AEL/AFL** button. Use this when you want to adjust the focus and exposure separately or when you want to shoot several images at the same exposure.

- If you press the **AEL/AFL** button once, the exposure is locked and **AEL** is displayed.  “AEL/AFL” (P. 115)
- Press the **AEL/AFL** button once again to release the AE Lock.
- The lock will be released if you operate the mode dial, **MENU** button, or **OK** button.
- If another role is assigned to the **Fn1** button, choose **[Fn1]** (P. 85).

Digital Zoom (Digital Tele-converter)

Press the **Qz** button to zoom in beyond the current zoom ratio. The display zoom ratio will double and any photographs taken will show the area visible in the monitor.

- **Qz** is displayed on the monitor.
- To exit digital zoom, press the **Qz** button again.
- Digital zoom is not available when multiple exposure, panorama, or keystone compensation is selected in **AP** mode or when [Standard] is selected in movie mode.
- When a RAW image is displayed, the area visible in the monitor is indicated by a frame.
- AF target drops.
- If another role is assigned to the **Fn2** button, choose **[Fn2]** (P. 85).

Selecting the AF target mode (AF target settings)

You can choose the position and size of the focus area for autofocus. You can also select Face priority AF (P. 62).

- 1 Press \triangleleft .
- 2 Select [\blacksquare] (Single Target) or [$\blacksquare\blacksquare\blacksquare$] (9-Target Group) using the front dial.

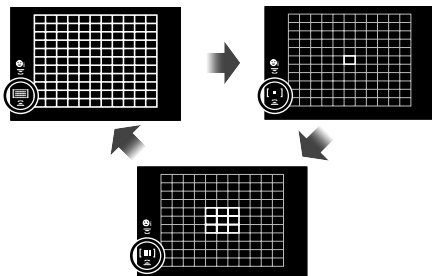

$\blacksquare\blacksquare\blacksquare\blacksquare$ All Targets	The camera automatically chooses from the full set of focus targets.
\blacksquare Single Target	You can choose a single AF target.
$\blacksquare\blacksquare\blacksquare$ 9-Target Group	The camera automatically chooses from the targets in the selected nine-target group.

- The single target mode is automatically applied in movie shooting if the group target mode is set.
- When using a Four Thirds system lens, the camera automatically switches to single target mode.

Setting the AF target

Select the single target or group target position.

- 1 Press \triangleleft .
 - If [$\blacksquare\blacksquare\blacksquare\blacksquare$] (All Targets) is selected, select [\blacksquare] (Single Target) or [$\blacksquare\blacksquare\blacksquare$] (9-Target Group) using the front dial.
- 2 Use \triangle ∇ \triangleleft \triangleright to choose a focus area.
 - The size and number of the AF targets changes with the aspect ratio (P. 73) and the option selected for [Digital Tele-converter] (P. 99).

Notes



- Touch controls can also be used.

Face priority AF/Eye priority AF

The camera detects faces and adjusts focus and digital ESP.

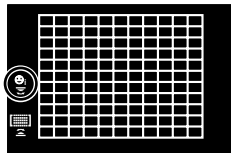
- 1 Press \triangleleft .
- 2 Select an option using the rear dial.



 Face Priority On	Face priority is on.
 Face Priority Off	Face priority is off.
 Face & Eye Priority On	The autofocus system selects the eye closest to the camera for face-priority AF.

- 3 Point the camera at your subject.
 - If a face is detected, it will be indicated by a white frame.
- 4 Press the shutter button halfway to focus.
 - When the camera focuses on the face in the white frame, the frame will turn green.
 - If the camera is able to detect the subject's eyes, it will display a green frame over the selected eye. (eye priority AF)
- 5 Press the shutter button the rest of the way down to shoot.



- During sequential shooting, face priority applies only to the first shot in each sequence.
- Depending on the subject and the art filter setting, the camera may not be able to correctly detect the face.
- When set to [ESP] (Digital ESP metering)] (P. 80), metering is performed with priority given to faces.

Notes

- Face priority is also available in [MF] (P. 72). Faces detected by the camera are indicated by white frames.

Changing ISO sensitivity (ISO)

Increasing ISO sensitivity increases noise (graininess) but allows photographs to be taken when lighting is poor. The setting recommended in most situations is [AUTO], which starts at ISO 200—a value that balances noise and dynamic range—and then adjusts ISO sensitivity according to shooting conditions.

- 1 Press Δ .
- 2 Rotate the front dial to choose an option.

AUTO	The sensitivity is set automatically according to the shooting conditions. The maximum ISO sensitivity value and other auto ISO settings can be adjusted using the [ISO-Auto Set] option in custom menus (P. 111).
LOW, 200–25600	The sensitivity is set to the selected value.

Using a flash (Flash photography)

The flash can be set manually as required. The flash can be used for flash photography in a variety of shooting conditions.

- 1 Rotate the **ON/OFF** lever to **UP** to raise the flash.

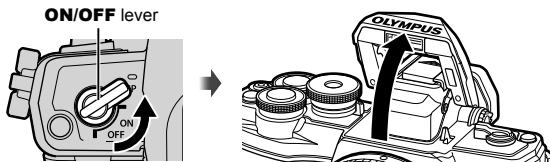

- 2 Press \blacktriangleright .
- 3 Select an item using the front dial and press the \odot button.
 - The options available and the order in which they are displayed vary depending on the shooting mode. INFO "Flash modes that can be set by shooting mode" (P. 65)

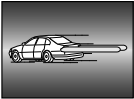
\downarrow	Flash	The flash fires regardless of the light conditions.
\downarrow \odot	Red-eye reduction flash	The flash fires so that the red-eye phenomenon is reduced.
\odot	Flash off	The flash does not fire.
\downarrow \odot SLOW	Slow synchronization (1st curtain)/Red-eye reduction flash	The slow synchronization is combined with the red-eye reduction flash.
\downarrow SLOW	Slow synchronization (1st curtain)	The flash fires with slow shutter speeds to brighten dimly-lit backgrounds.
$\frac{1}{2}$ SLOW2	Slow synchronization (2nd curtain)	The flash fires immediately before the shutter closes to create trails of light behind moving light sources. 
\downarrow FULL. \downarrow 1/4 etc.	Manual flash	For users who prefer manual operation. Press the INFO button and use \blacktriangle \blacktriangledown to adjust flash output.

- In [\downarrow \odot (Red-eye reduction flash)], after the pre-flashes, it takes about 1 second before the shutter is released. Do not move the camera until shooting is complete.
- [\downarrow \odot (Red-eye reduction flash)] may not work effectively under some shooting conditions.
- When the flash fires, the shutter speed is set to 1/250 seconds or slower. When shooting a subject against a bright background with the flash, the background may be overexposed.

Flash modes that can be set by shooting mode

Shooting mode	Monitor	Flash mode	Flash timing	Conditions for firing the flash	Shutter speed limit
P/A		Flash	1st curtain	Always fires	30 sec. – 1/250 sec.*
		Red-eye reduction			1/30 sec. – 1/250 sec.*
		Flash off	—	—	—
		Slow synchronization (red-eye reduction flash)	1st curtain	Always fires	60 sec. – 1/250 sec.*
		Slow Synchronization (1st curtain)			
		Slow synchronization (2nd curtain)	2nd curtain		
S/M		Flash	1st curtain	Always fires	60 sec. – 1/250 sec.*
		Red-eye reduction flash			
		Flash off	—	—	—
		Slow synchronization (2nd curtain)	2nd curtain	Always fires	60 sec. – 1/250 sec.*

• Only and can be set in mode.

* The shutter speed is 1/200 seconds when using a separately sold external flash.

Minimum range

The lens may cast shadows over objects close to the camera, causing vignetting, or the flash may be too bright even at minimum output.









Lens	Approximate distance at which vignetting occurs
14-42mm F3.5-5.6 II R	1 m
ED 14-42mm F3.5-5.6 EZ	0.5 m
ED 40-150mm F4.0-5.6 R	0.9 m
ED 14-150mm F4.0-5.6 II	0.5 m

• External flash units can be used to prevent vignetting. To prevent photographs from being overexposed, select **A** or **M** mode, and choose a high aperture value or reduce ISO sensitivity.

Performing the sequential/self-timer shooting



You can take a series of pictures by keeping the shutter button pressed all the way down. Alternatively, you can take pictures using the self-timer.

- 1 Press ∇ .
- 2 Highlight one of the following options using $\triangleleft \triangleright$.

 Single	1 frame is taken at a time when the shutter button is pressed.
 Sequential High	Pictures are taken at up to about 8.6 frames per second (fps) while the shutter button is pressed all the way down. Focus, exposure, and white balance are fixed at the values for the first shot in each series.
 Sequential Low	Pictures are taken at up to about 4.8 frames per second (fps) while the shutter button is pressed all the way down. Focus and exposure are fixed according to the options selected for [AF Mode] (P. 72) and [AEL/AFL] (P. 115).
 12s  12 sec	Press the shutter button halfway to focus, the rest of the way down to start the timer. First, the self-timer lamp lights up for approximately 10 seconds, then it blinks for approximately 2 seconds and the picture is taken.
 2s  2 sec	Press the shutter button halfway to focus, the rest of the way down to start the timer. The self-timer lamp blinks for approximately 2 seconds, and then the picture is taken.
 Custom Self-timer	Press the INFO button to set [Timer], [Number of Frames], and [Interval Length]. Use $\triangleleft \triangleright$ to highlight items and $\triangle \nabla$ to choose a value.

* Items marked with \blacklozenge use the electronic shutter to control the small amount of camera blur caused by operation of the shutter.

3 Press the \odot button.

- Fix the camera securely on a tripod for self-timer shooting.
- If you stand in front of the camera to press the shutter button when using the self-timer, the picture may be out of focus.
- When you are using  or , live view is displayed. In , the display shows the last photograph taken during the sequential shooting.
- The speed of sequential shooting varies depending on the lens you are using and the focus of the zoom lens.
- During sequential shooting, if the battery level icon blinks due to low battery, the camera stops shooting and starts saving the pictures you have taken on the card. The camera may not save all of the pictures depending on how much battery power remains.

Notes

- To cancel the activated self-timer, press ∇ .
- Sequential/self-timer shooting is available in silent mode (P. 37).

Calling shooting options

■ Live control

You can use live control to select the shooting function while checking the effect on the screen.



■ Available settings

Picture mode*1	P. 69
ISO sensitivity*1	P. 63
White balance*1	P. 70
AF mode*1	P. 72
Aspect ratio	P. 73

Camera icon*1	P. 73
Person icon*1	P. 74
Movie (exposure) mode*1	P. 76
Scene mode*2	P. 29
Art filter mode*3	P. 42

*1 Available in movie mode.

*2 Available in **SCN** mode.

*3 Available in **ART** mode.

1 Press **OK** to display the live control.

- To hide the live control, press **OK** again.

2 Use **Δ**/**▽** to highlight the desired function and **◀**/**▶** to highlight a setting, and then press the **OK** button.

- The selected settings take effect automatically if no operations are performed for about 8 seconds.

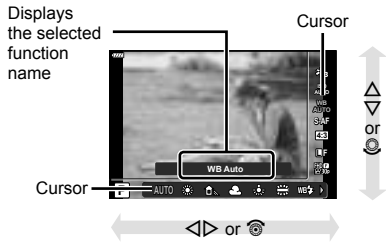

- Some items are not available in some shooting modes.

📌 Notes

- For the default settings of each option, refer to “Defaults” (P. 148).

■ LV super control panel

Other shooting options can be accessed via the LV super control panel, which lists the options selected for the following shooting settings.

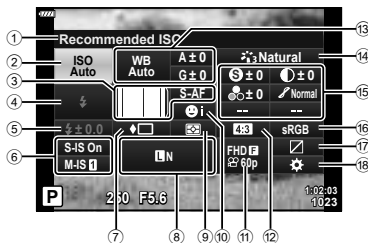

Settings that can be modified using LV super control panel

- | | |
|---|---|
| ① Currently selected option | ⑭ Picture mode..... P. 69 |
| ② ISO sensitivity..... P. 63 | ⑮ Sharpness S^{*1} P. 80 |
| ③ AF mode..... P. 72 | Contrast C^{*1} P. 81 |
| AF target..... P. 61 | Saturation SA^{*1} P. 81 |
| ④ Flash mode..... P. 64 | Gradation G^{*1} P. 82 |
| ⑤ Flash intensity control..... P. 77 | Color filter CF^{*1} P. 82 |
| ⑥ Image stabilizer..... P. 78 | Monochrome color I^{*1} P. 83 |
| ⑦ Sequential shooting/Self-timer..... P. 66 | Effect E^{*1} P. 83 |
| ⑧ P. 73 | Color C^{*1*2} P. 44 |
| ⑨ Metering mode..... P. 80 | Color/Vivid CV^{*1*3} P. 69 |
| ⑩ Face priority..... P. 62 | ⑯ Color space..... P. 84 |
| ⑪ P. 74 | ⑰ Highlight & shadow control..... P. 84 |
| ⑫ Aspect ratio..... P. 73 | ⑱ Button function assignment..... P. 85 |
| ⑬ White balance..... P. 70 | |
| White balance compensation..... P. 79 | |

*1 The display may differ when Art Filter is selected for picture mode.

*2 Displayed when Partial Color is set.

*3 Displayed when Color Creator is set.

1 Press the button in P/A/S/M modes.

- The LV super control panel will be displayed.
- In **Auto**, **ART**, **SCN**, and **AP** modes, the display of the LV super control panel is controlled via **[Control Settings]** (P. 110).
- The LV super control panel is not displayed in movie mode.



2 Highlight an item using Δ ∇ \leftarrow \rightarrow and press the \odot button.

3 Use \leftarrow \rightarrow to highlight an option.

Notes

- Settings can also be adjusted using the dials or touch controls.
- For the default settings of each option, refer to "Defaults" (P. 148).

Processing options (Picture Mode)

You can select a picture mode and make individual adjustments to contrast, sharpness, and other parameters (P. 80–83). Changes to each picture mode are stored separately.

- 1 Press the **OK** button and use Δ ∇ to highlight Picture Mode.
- 2 Highlight an option using \leftarrow \rightarrow and press the **OK** button.

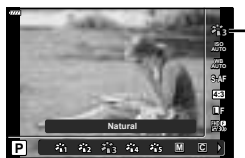

Picture Mode

Picture mode options

i-Enhance	Produces more impressive-looking results suited to the scene.
Vivid	Produces vivid colors.
Natural	Produces natural colors.
Muted	Produces flat tones.
Portrait	Produces beautiful skin tones.
Monochrome	Produces black and white tone.
Custom	Use to select one picture mode, set the parameters, and register the setting.
e-Portrait	Produces smooth skin textures. This mode cannot be used with bracket photography or when shooting movies.
Color Creator*1	Provides a color finish set in Color Creator.
ART 1 Pop Art	Uses Art Filter settings. Art effects can also be used.
ART 2 Soft Focus	
ART 3 Pale&Light Color	
ART 4 Light Tone	
ART 5 Grainy Film	
ART 6 Pin Hole	
ART 7 Diorama	
ART 8 Cross Process	
ART 9 Gentle Sepia	
ART 10 Dramatic Tone	
ART 11 Key Line	
ART 12 Watercolor	
ART 13 Vintage	
ART 14 Partial Color*2	
ART 15 Bleach Bypass	

*1 After choosing Color Creator using the \leftarrow \rightarrow buttons, press the **INFO** button and use the front dial to adjust hue and the rear dial to adjust saturation.

*2 After choosing Partial Color using \leftarrow \rightarrow , press the **INFO** button to display the color ring (P. 44).

Adjusting color (WB (white balance))

White balance (WB) ensures that white objects in images recorded by the camera appear white. [AUTO] is suitable in most circumstances, but other values can be selected according to the light source when [AUTO] fails to produce the desired results or you wish to introduce a deliberate color cast into your images.

- 1 Press the **OK** button and use Δ ∇ to highlight White Balance.
- 2 Highlight an option using \triangleleft \triangleright and press the **OK** button.



White Balance

WB mode		Color temperature	Light conditions
Auto white balance	AUTO	—	For most light conditions (when there is a white portion framed on the monitor). Use this mode for general use.
Preset white balance		5300 K	For shooting outdoors on a clear day, or to capture the reds in a sunset or the colors in a fireworks display
		7500 K	For shooting outdoors in the shadows on a clear day
		6000 K	For shooting outdoors on a cloudy day
		3000 K	For shooting under a tungsten light
		4000 K	For shooting under a fluorescent light
		5500 K	For flash shooting
One-touch white balance	 	Color temperature set by one-touch WB	Press the INFO button to measure white balance using a white or gray target when using a flash or other light source of an unknown type or when shooting under mixed lighting. “One-touch white balance” (P. 71)
Custom white balance	CWB	2000 K–14000 K	After pressing the INFO button, use Δ ∇ \triangleleft \triangleright to select a color temperature and then press the OK button.

One-touch white balance

Measure white balance by framing a piece of paper or other white object under the lighting that will be used in the final photograph. This is useful when shooting a subject under natural light, as well as under various light sources with different color temperatures.

- 1 Select [W1], [W2], [W3], or [W4] (one-touch white balance 1, 2, 3, or 4) and press the **INFO** button.
- 2 Photograph a piece of colorless (white or gray) paper.
 - Frame the paper so that it fills the display and no shadows fall it.
 - The one-touch white balance screen appears.
- 3 Select [Yes] and press the **OK** button.
 - The new value is saved as a preset white balance option.
 - The new value is stored until one-touch white balance is measured again. Turning the power off does not erase the data.

Choosing a focus mode (AF Mode)

You can select a focusing method (focus mode). You can choose separate focusing methods for still photography mode and movie mode.

- 1 Press the **OK** button and use **△▽** to highlight AF Mode.

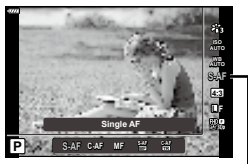

AF Mode

- 2 Highlight an option using **◀▶** and press the **OK** button.

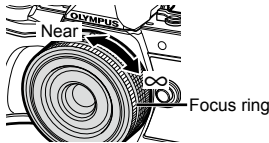
S-AF (Single AF)	The camera focuses once when the shutter button is pressed halfway. When the focus is locked, a beep sounds, and the AF confirmation mark and the AF target mark light up. This mode is suitable for taking pictures of still subjects or subjects with limited movement.
C-AF (Continuous AF)	The camera repeats focusing while the shutter button remains pressed halfway. When the subject is in focus, the AF confirmation mark lights up on the monitor and the beep sounds when the focus is locked at the first time. Even if the subject moves or you change the composition of the picture, the camera continues trying to focus. <ul style="list-style-type: none"> • When using a Four Thirds system lens, this setting will change to [S-AF].
MF (Manual focus)	This function allows you to manually focus on any position by operating the focus ring on the lens. 
S-AF+MF (Simultaneous use of S-AF mode and MF mode)	After pressing the shutter button halfway to focus in [S-AF] mode, you can turn the focus ring to fine-adjust focus manually.
C-AF+TR (AF tracking)	Press the shutter button halfway to focus; the camera then tracks and maintains focus on the current subject while the shutter button is held in this position. <ul style="list-style-type: none"> • The AF target is displayed in red if the camera can no longer track the subject. Release the shutter button and then frame the subject again and press the shutter button halfway. • When using a Four Thirds system lens, this setting will change to [S-AF].

- The camera may be unable to focus if the subject is poorly lit, obscured by mist or smoke, or lacks contrast.
- When using a Four Thirds system lens, AF will not be available during movie recording.
- AF mode is unavailable when the lens MF focus clutch is set to MF.

Setting the image aspect

You can change the aspect ratio (horizontal-to-vertical ratio) when taking pictures. Depending on your preference, you can set the aspect ratio to [4:3] (standard), [16:9], [3:2], [1:1], or [3:4].

- 1 Press the **OK** button and use **Δ** **▽** to highlight Image Aspect.
- 2 Use **◀▶** to choose a value and press the **OK** button.



Image Aspect

- Image aspect can only be set for still images.
- JPEG images cropped to the selected aspect ratio are saved. RAW images are not cropped and are saved with the selected aspect ratio information.
- When RAW images are played back, the selected aspect ratio is shown by a frame.

Selecting image quality (Still image quality, **☺** **◀▶**)

You can set an image quality mode for still images. Select a quality suitable for the application (such as for processing on PC, use on website etc.).

- 1 Press the **OK** button and use **Δ** **▽** to highlight (Still image quality, **☺** **◀▶**).



Still Image Quality

- 2 Highlight an option using **◀▶** and press the **OK** button.
 - Choose from JPEG (**L**F, **L**N, **M**N, and **S**N) and RAW modes. Choose a JPEG+RAW option to record both a JPEG and a RAW image with each shot. JPEG modes combine image size (**L**, **M**, and **S**) and compression ratio (SF, F, N, and B).
 - When you want to select a combination other than **L**F, **L**N, **M**N, and **S**N, change the [**◀▶** Set] (P. 112) settings in Custom Menu.









RAW image data

This format (extension “.ORF”) stores unprocessed image data for later processing. RAW image data cannot be viewed using other cameras or software, and RAW images cannot be selected for printing. JPEG copies of RAW images can be created using this camera.

☺ “Editing still images (Edit)” (P. 103)

Selecting image quality (Movie quality,)

You can set a movie record mode suitable for the desired use.

- 1 Press the  button and use   to highlight (Movie quality,  ).
- 2 Use   to choose a value and press the  button.





















Movie Quality

■ Available Movie Quality Options



The options available for movie quality vary with the movie mode (P. 53) and the options selected for [Video Frame Rate] and [Video Bit Rate] in the video menu (P. 102).

The following options are available when [Standard] is selected for movie mode or the mode dial is rotated to a position other than :









Video Frame Rate	Video Bit Rate	Movie quality
30p	Super Fine	 1920×1080 Super Fine 60p
		 1920×1080 Super Fine 30p
		 1280×720 Super Fine 30p
	Fine	 1920×1080 Fine 60p
		 1920×1080 Fine 30p
		 1280×720 Fine 30p
	Normal	 1920×1080 Normal 60p
		 1920×1080 Normal 30p
		 1280×720 Normal 30p
25p	Super Fine	 1920×1080 Super Fine 50p
		 1920×1080 Super Fine 25p
		 1280×720 Super Fine 25p
	Fine	 1920×1080 Fine 50p
		 1920×1080 Fine 25p
		 1280×720 Fine 25p
	Normal	 1920×1080 Normal 50p
		 1920×1080 Normal 25p
		 1280×720 Normal 25p

Video Frame Rate	Video Bit Rate	Movie quality
24p	Super Fine	 1920×1080 Super Fine 24p
		 1280×720 Super Fine 24p
	Fine	 1920×1080 Fine 24p
		 1280×720 Fine 24p
	Normal	 1920×1080 Normal 24p
		 1280×720 Normal 24p

The following options are available when [4K] is selected for movie mode:

Video Frame Rate	Video Bit Rate	Movie quality
30p	Not selectable	 3840×2160 30p
25p		 3840×2160 25p
24p		 3840×2160 24p

The following options are available when [Clips] is selected for movie mode:

Video Frame Rate	Video Bit Rate	Movie quality
30p	Not selectable	 1920×1080 Normal 60p
		 1920×1080 Normal 30p
		 1280×720 Normal 30p
25p		 1920×1080 Normal 50p
		 1920×1080 Normal 25p
		 1280×720 Normal 25p
24p		 1920×1080 Normal 24p
		 1280×720 Normal 24p







The following option is available when [High-speed] is selected for movie mode:

Video Frame Rate	Video Bit Rate	Movie quality
Not selectable		 1280×720 HighSpeed 120fps

- Movies are stored in MPEG-4 AVC/H.264 format. The maximum size of individual file is limited to 4 GB. The maximum recording time of individual movie is limited to 29 minutes.
- Depending on the type of card used, recording may end before the maximum length is reached.









Adding effects to a movie

You can create movies that take advantage of the effects available in still photography mode.

- 1 Rotate the mode dial to .
- 2 Press the  button and use   to highlight movie (exposure) mode.
- 3 Use   to choose a value and press the  button.





Movie (exposure) mode

P	Optimal aperture is set automatically according to the brightness of the subject. Use the front dial () or rear dial () to adjust exposure compensation.
A	Depiction of background is changed by setting the aperture. Use the front dial () to adjust exposure compensation and rear dial () to adjust aperture.
S	Shutter speed affects how the subject appears. Use the front dial () to adjust exposure compensation and rear dial () to adjust shutter speed. Shutter speed can be set to values between 1/24 s and 1/4000 s.
M	Aperture and shutter speed can be manually set. Use the front dial () to select aperture value and the rear dial () to select shutter speed. Shutter speed can be set to values between 1/24 s and 1/4000 s. ISO sensitivity can only be set manually to values between 200 and 6400.

- Blurred frames caused by such factors as the subject moving while the shutter is open can be reduced by selecting the fastest available shutter speed.
- The low end of the shutter speed changes according to the frame rate of the movie record mode.
- Excessive camera shake may not be compensated enough.
- When the inside of the camera becomes hot, shooting is automatically stopped to protect the camera.
- With some art filters, [C-AF] function is limited.

Adjusting flash output (Flash intensity control)

Flash output can be adjusted if you find that your subject appears overexposed, or is underexposed even though the exposure in the rest of the frame is just right.

- 1 Press the  button in **P/A/S/M** modes.
 - In **Auto**, **ART**, **SCN**, and **AP** modes, the display of the LV super control panel is controlled via [Control Settings] (P. 110).
- 2 Use Δ ∇ \langle \rangle to select , then press the \odot button.
- 3 Use \langle \rangle to choose a value and press the \odot button.

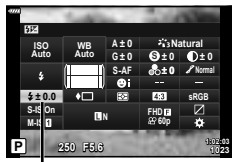



Flash intensity control

- This setting has no effect when the flash control mode for the external flash unit is set to **MANUAL**.
- Changes to flash intensity made with the external flash unit are added to those made with the camera.

Reducing camera shake (Image Stabilizer)

You can reduce the amount of camera shake that can occur when shooting in low light situations or shooting with high magnification.

The image stabilizer starts when you press the shutter button halfway.

- Press the  button in **P/A/S/M** modes.
 - In **Auto**, **ART**, **SCN**, and **AP** modes, the display of the LV super control panel is controlled via [Control Settings] (P. 110).
- Use Δ ∇ \langle \rangle to select [Image Stabilizer], then press the  button.
- Highlight an option using \langle \rangle and press the  button.

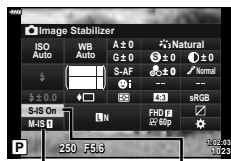

 Image Stabilizer

 Image Stabilizer

Still picture (S-IS)	S-IS Off	Image stabilizer is off.
	S-IS On	The camera detects the panning direction and applies the appropriate image stabilization.
Movie (M-IS)	M-IS Off	Image stabilizer is off.
	M-IS 1	The camera uses both sensor shift (VCM) and electronic correction.
	M-IS 2	The camera uses sensor shift (VCM) correction only. Electronic correction is not used.

- The image stabilizer cannot correct excessive camera shake or camera shake that occurs when the shutter speed is set to the slowest speed. In these cases, it is recommended that you use a tripod.
- When using a tripod, set [Image Stabilizer] to [S-IS Off]/[M-IS Off].
- When using a lens with an image stabilization function switch, priority is given to the lens side setting.
- You may notice an operating sound or vibration when the image stabilizer is activated.

Using lenses other than Micro Four Thirds/Four Thirds System lenses

You can use focal length information to reduce camera shake when shooting with lenses that are not Micro Four Thirds or Four Thirds system lenses.

- Press the **INFO** button while [Image Stabilizer] is selected, use Δ ∇ \langle \rangle to highlight a focal length, and press the  button.
- Choose a focal length between 0.1 mm and 1000.0 mm.
- Choose the value that matches the one printed on the lens.
- Selecting [Reset] (basic) in Shooting Menu 1 does not reset the focal length.

Making fine adjustments to white balance (WB Compensation)

You can set and finely adjust the compensation values for both auto white balance and preset white balance.

Before proceeding, choose a white balance option to which to make fine adjustments.

“Adjusting color (WB (white balance))” (P. 70)

- 1 Press the button in **P/A/S/M** modes.
 - In **Auto**, **ART**, **SCN**, and **AP** modes, the display of the LV super control panel is controlled via Control Settings] (P. 110).
- 2 Highlight white balance compensation using and press the button.
- 3 Use to choose an axis.
- 4 Choose a value using and press the button.

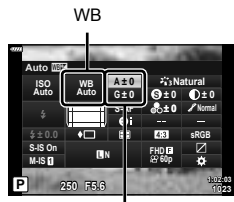

White balance compensation

For compensation on the A axis (Red-Blue)

Move the bar in the + direction to emphasize red tones and in the – direction to emphasize blue tones.

For compensation on the G axis (Green-Magenta)

Move the bar in the + direction to emphasize green tones and in the – direction to emphasize magenta tones.

- Selecting [Reset] (basic) in Shooting Menu 1 does not reset the values selected.

Choosing how the camera measures brightness (Metering)

You can choose how the camera meters subject brightness.

- Press the button in **P/A/S/M** modes.
 - In **Auto**, **ART**, **SCN**, and **AP** modes, the display of the LV super control panel is controlled via Control Settings] (P. 110).
- Use to select [Metering], then press the button.
- Highlight an option using and press the button.



Metering

	Digital ESP metering	Meters exposure in 324 areas of the frame and optimizes exposure for the current scene or portrait subject (if an option other than [OFF] is selected for [Face Priority]). This mode is recommended for general use.	
	Center weighted averaging metering	Provides the average metering between the subject and the background lighting, placing more weight on the subject at the center.	
	Spot metering	Meters a small area (about 2% of the frame) with the camera pointed at the object you wish to meter. Exposure will be adjusted according to the brightness at the metered point.	
	Spot metering (highlight)	Increases spot metering exposure. Ensures bright subjects appear bright.	
	Spot metering (shadow)	Lowers spot metering exposure. Ensures dark subjects appear dark.	

Making fine adjustments to sharpness (Sharpness)

In the picture mode (P. 69) settings, you can make fine adjustments to sharpness and store the changes.

- Adjustments may not be available depending on the shooting mode (P. 24).

- Press the button in **P/A/S/M** modes.
 - In **Auto**, **ART**, **SCN**, and **AP** modes, the display of the LV super control panel is controlled via Control Settings] (P. 110).
- Use to select [Sharpness], then press the button.
- Adjust sharpness using and press the button.

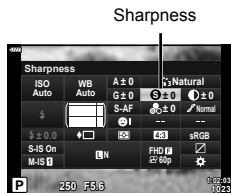



Sharpness

Making fine adjustments to contrast (Contrast)

In the picture mode (P. 69) settings, you can make fine adjustments to contrast and store the changes.

- Adjustments may not be available depending on the shooting mode (P. 24).

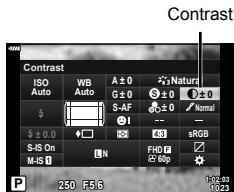

- Press the  button in **P/A/S/M** modes.
 - In **Auto**, **ART**, **SCN**, and **AP** modes, the display of the LV super control panel is controlled via [Control Settings] (P. 110).
- Use $\Delta \nabla \triangleleft \triangleright$ to select [Contrast], then press the  button.
- Adjust contrast using $\triangleleft \triangleright$ and press the  button.



Making fine adjustments to saturation (Saturation)

In the picture mode (P. 69) settings, you can make fine adjustments to saturation and store the changes.

- Adjustments may not be available depending on the shooting mode (P. 24).

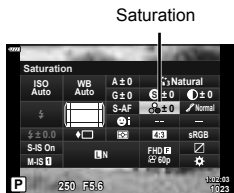

- Press the  button in **P/A/S/M** modes.
 - In **Auto**, **ART**, **SCN**, and **AP** modes, the display of the LV super control panel is controlled via [Control Settings] (P. 110).
- Use $\Delta \nabla \triangleleft \triangleright$ to select [Saturation], then press the  button.
- Adjust saturation using $\triangleleft \triangleright$ and press the  button.



Making fine adjustments to tone (Gradation)

In the picture mode (P. 69) settings, you can make fine adjustments to tone and store the changes.

- Adjustments may not be available depending on the shooting mode (P. 24).

- Press the  button in **P/A/S/M** modes.
 - In **Auto**, **ART**, **SCN**, and **AP** modes, the display of the LV super control panel is controlled via [Control Settings] (P. 110).
- Use $\Delta \nabla \triangleleft \triangleright$ to select [Gradation], then press the  button.
- Adjust tone using $\triangleleft \triangleright$ and press the  button.

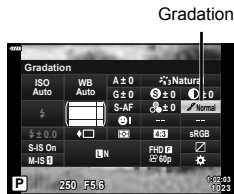



Gradation

AUTO: Auto	Divides the image into detailed regions and adjusts the brightness separately for each region. This is effective for images with areas of large contrast in which the whites appear too bright or the blacks appear too dark.
NORM: Normal	Use the normal mode for general uses.
HIGH: High Key	Uses a tone suitable for a bright subject.
LOW: Low Key	Uses a tone suitable for a dark subject.

Applying filter effects to monochrome pictures (Color Filter)

In the monochrome setting of picture mode (P. 69) settings, you can add and store a filter effect in advance. This creates a monochrome image in which the color matching the filter color is brightened and the complementary color is darkened.

- Press the  button in **P/A/S/M** modes.
 - In **Auto**, **ART**, **SCN**, and **AP** modes, the display of the LV super control panel is controlled via [Control Settings] (P. 110).
- Use $\Delta \nabla \triangleleft \triangleright$ to select [Color Filter], then press the  button.
- Highlight an option using $\triangleleft \triangleright$ and press the  button.

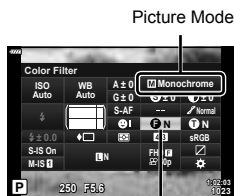

Picture Mode

Color Filter

N:None	Creates a normal black and white image.
Ye:Yellow	Reproduces clearly defined white cloud with natural blue sky.
Or:Orange	Slightly emphasizes colors in blue skies and sunsets.
R:Red	Strongly emphasizes colors in blue skies and brightness of crimson foliage.
G:Green	Strongly emphasizes colors in red lips and green leaves.

Adjusting the tone of a monochrome image (Monochrome Color)

In the monochrome setting of picture mode (P. 69) settings, you can add and store a color tint in advance.

- Press the button in **P/A/S/M** modes.
 - In **Auto**, **ART**, **SCN**, and **AP** modes, the display of the LV super control panel is controlled via [Control Settings] (P. 110).
- Use Δ ∇ \triangleleft \triangleright to select [Monochrome Color], then press the button.
- Use \triangleleft \triangleright to choose a value and press the button.

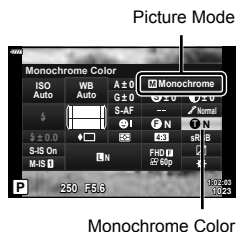

Monochrome Color

N:None	Creates a normal black and white image.
S:Sepia	Creates a sepia image.
B:Blue	Creates a bluish image.
P:Purple	Creates a purplish image.
G:Green	Creates a greenish image.

Adjusting i-Enhance effects (Effect)

You can set the i-Enhance effect strength in picture mode (P. 69).

- Press the button in **P/A/S/M** modes.
 - In **Auto**, **ART**, **SCN**, and **AP** modes, the display of the LV super control panel is controlled via [Control Settings] (P. 110).
- Use Δ ∇ \triangleleft \triangleright to select [Effect], then press the button.
- Adjust the effect using \triangleleft \triangleright and press the button.

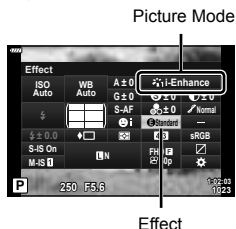

Effect

Effect LOW (Effect: Low)	Adds a low i-Enhance effect to images.
Effect STD (Effect: Standard)	Adds an i-Enhance effect between "low" and "high" to images.
Effect HIGH (Effect: High)	Adds a high i-Enhance effect to images.

Setting the color reproduction format (Color Space)

You can select a format to ensure that colors are correctly reproduced when shot images are regenerated on a monitor or using a printer. This option is equivalent to the [Color Space] (P. 112) in Custom Menu.

- 1 Press the button in **P/A/S/M** modes.
 - In **Auto**, **ART**, **SCN**, and **AP** modes, the display of the LV super control panel is controlled via Control Settings] (P. 110).
- 2 Use Δ ∇ \langle \rangle to select [Color Space], then press the button.
- 3 Select a color format using \langle \rangle and press the button.

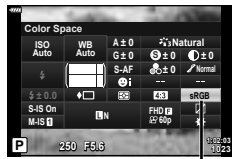

Color Space

sRGB	This is the RGB color space standard stipulated by the International Electrotechnical Commission (IEC). Normally, use [sRGB] as the standard setting.
AdobeRGB	This is a standard provided by Adobe Systems. Compatible software and hardware such as a display, printer etc. are required for a correct output of images.

- [Adobe RGB] is not available in **ART** (P. 42) or movie mode (P. 53) or when Backlight HDR is selected in **SCN** mode (P. 29) or HDR is selected in **AP** mode (P. 36).

Changing the brightness of highlights and shadows (Highlight&Shadow Control)

Use [Highlight&Shadow Control] to adjust the brightness of highlights and shadows.

- 1 Press the button in **P/A/S/M** modes.
 - In **Auto**, **ART**, **SCN**, and **AP** modes, the display of the LV super control panel is controlled via Control Settings] (P. 110).
- 2 Use Δ ∇ \langle \rangle to select [Highlight&Shadow Control], then press the button.
- 3 Adjust brightness in shadows with \langle \rangle and in highlights with Δ ∇ .
 - Settings can be reset by pressing and holding the button.
 - Press the **INFO** button to view the mid-tone adjustment display.
- 4 Press the button to save settings.

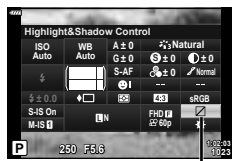

Highlight&Shadow Control



Assigning functions to buttons (Button Function)

At default settings, the following functions are assigned to the buttons:

Button	Default
Fn1 Function	AEL/AFL (AEL/AFL)
Fn2 Function	DC (Digital Tele-converter)

To change the function assigned to a button, follow the steps below.

- Press the **Fn** button in **P/A/S/M** modes.
 - In **Auto**, **ART**, **SCN**, and **AP** modes, the display of the LV super control panel is controlled via [Control Settings] (P. 110).
- Use **△▽◀▶** to select [Button Function], then press the **OK** button.
 - The custom menu [Button Function] item will be displayed.

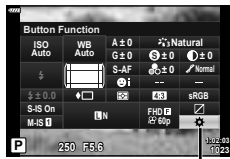















Button Function

- Use **△▽** to highlight the desired button and press **▶**.
- Use **△▽** to highlight the desired function and press the **OK** button.
- Press the **OK** button again to exit.

Notes

- The functions assigned to the buttons may be unavailable in some modes.
- The options available vary with the current mode.

 (AEL/AF-L)	Press the button to use AE lock or AF lock. The function changes according to the [AEL/AF-L] (P. 115) setting. When AEL is selected, press the button once to lock the exposure and display  on the monitor. Press the button again to cancel the lock.
 (Preview)	Aperture is stopped down to the selected value while the button is pressed.
 (One-touch white balance)	Press the shutter button while the button is pressed to acquire a white balance value (P. 71). Highlight the desired number and press the  button to save the value.
 (AF Area Select)	Press the button to choose the AF target (P. 61).
MF	Press the button to select [MF] mode. Press the button again to restore the previously selected AF mode. Hold the button and rotate the front or rear dial to choose a focus mode.
 (Exposure compensation)	Press the button to adjust exposure compensation. In P , A , S , ART ,  , and movie modes, you can adjust exposure compensation by pressing the button and using  or the front or rear dial to choose the desired value. In M mode, you can adjust shutter speed or aperture by pressing the button and using   or the front or rear dial to choose the desired values.
 (Digital Tele-converter)	Press the button to turn digital zoom [On] or [Off] (P. 99).
 (Magnify)	Press the button to display the magnification frame and press it again to magnify the image. Press and hold the button to cancel magnified display.
Peaking	Press the button to turn on and off the peaking display. When peaking is displayed, histogram and highlight/shadow display are not available (P. 115).
 (Switch Lock)	Press and hold the button to enable and disable touch screen operation.

■ Zoom frame AF/Zoom AF (Super Spot AF)

You can zoom in on a portion of the frame when adjusting focus. Choosing a high zoom ratio allows you to use autofocus to focus on a smaller area than is normally covered by the AF target. You can also position the focus target more precisely. Press and hold the button to which [Q] has been assigned to cycle through the displays as follows:

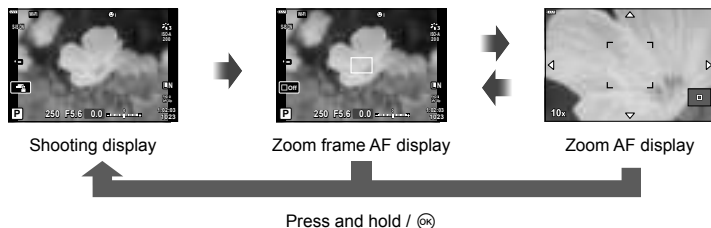

- 1 Assign [Q] to the **Fn1** or **Fn2** button.
 - To use Super Spot AF, you must first assign [Q] to the **Fn1** or **Fn2** button (P. 85).
 - 2 Press the button to which [Q] has been assigned to display the zoom frame.
 - If the subject has been focused using autofocus immediately before the button is pressed, the zoom frame will be displayed at the current focus position.
 - Use $\Delta \nabla \triangleleft \triangleright$ to position the zoom frame.
 - Press the **INFO** button and use $\Delta \nabla$ to choose the zoom ratio. ($\times 3$, $\times 5$, $\times 7$, $\times 10$, $\times 14$)
 - 3 Press the assigned button again to zoom in on the zoom frame.
 - Use $\Delta \nabla \triangleleft \triangleright$ to position the zoom frame.
 - You can change the zoom ratio by rotating the front dial () or rear dial ()
 - 4 Press the shutter button halfway to initiate autofocus.
 - The camera will focus using the subject in the frame at the center of the screen. Use $\Delta \nabla \triangleleft \triangleright$ to choose a different focus position.
- Zoom is visible only in the monitor and has no effect on the resulting photographs.
 - Press and hold the assigned button or press the button to end zoom and exit the zoom frame AF display.
 - When you are using a Four Thirds system lens, the AF will not operate with during zoom display.
 - While zoomed in, a sound is made by the IS (Image Stabilizer).

Notes

- Touch controls can also be used.

3 Playback

Information display during playback

Playback image information

Simplified display

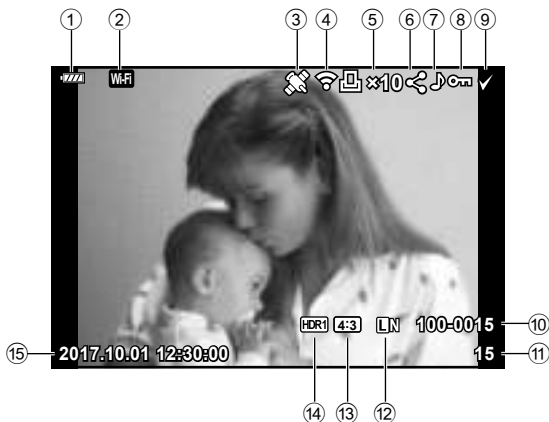

Overall display

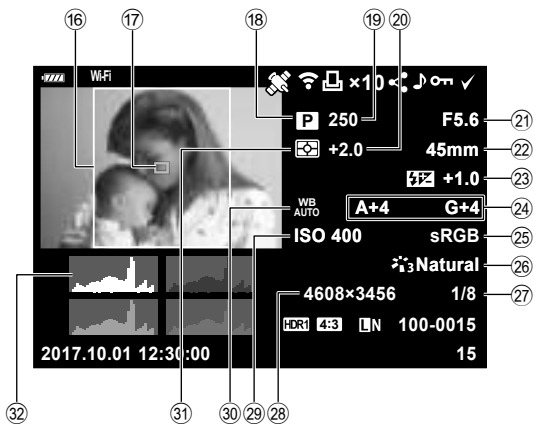

- | | |
|--|---|
| ① Battery level.....P. 18 | ①7 AF area pointer.....P. 61 |
| ② Wireless LAN connection.....P. 120–124 | ①8 Shooting mode.....P. 24–48 |
| ③ Including GPS information.....P. 123 | ①9 Shutter speed.....P. 45–48 |
| ④ Eye-Fi upload complete.....P. 114 | ②0 Exposure compensation.....P. 60 |
| ⑤ Print order
Number of prints.....P. 130 | ②1 Aperture value.....P. 45–48 |
| ⑥ Share order.....P. 94 | ②2 Focal length |
| ⑦ Sound record.....P. 95, 104 | ②3 Flash intensity control.....P. 77 |
| ⑧ Protect.....P. 93 | ②4 White balance compensation.....P. 79 |
| ⑨ Image selected.....P. 94 | ②5 Color space.....P. 84 |
| ⑩ File number.....P. 113 | ②6 Picture mode.....P. 69, 99 |
| ⑪ Frame number | ②7 Compression rate.....P. 119 |
| ⑫ Image quality.....P. 73 | ②8 Pixel count.....P. 119 |
| ⑬ Aspect ratio.....P. 73 | ②9 ISO sensitivity.....P. 63 |
| ⑭ HDR image.....P. 36 | ③0 White balance.....P. 70 |
| ⑮ Date and time.....P. 19 | ③1 Metering mode.....P. 80 |
| ⑯ Aspect border.....P. 73 | ③2 Histogram.....P. 23 |

Switching the information display

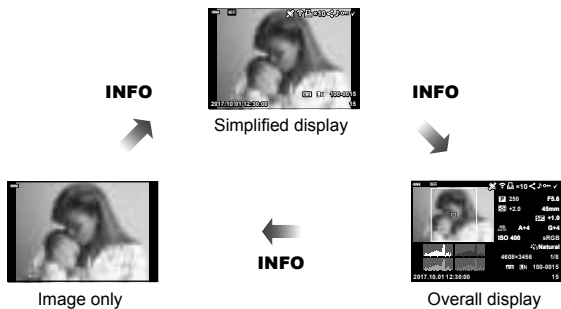
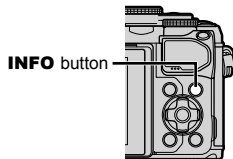

You can switch the information displayed during playback by pressing the **INFO** button.











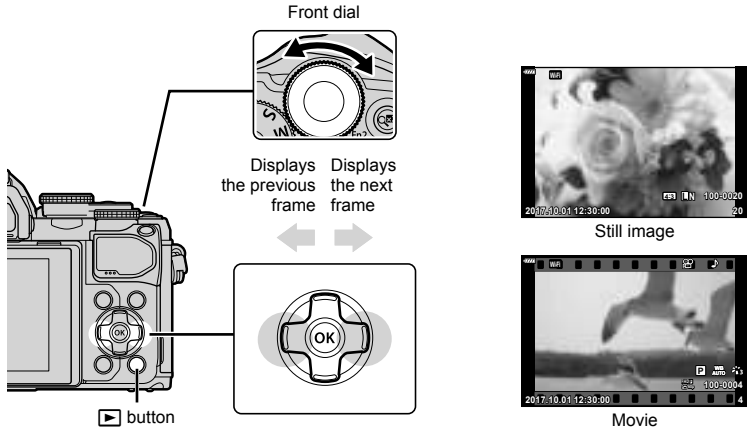















- You can add histogram, highlight & shadow, and Light Box to the information displayed during playback. [Info] (P. 116)

Viewing photographs and movies

1 Press the button.

- A photograph or movie will be displayed.
- Select the desired photograph or movie using the front dial () or arrow pad.
- To return to shooting mode, press the shutter button halfway or press the  button.





Rear dial ()	Zoom in () / Index ()
Front dial ()	Previous () / Next () Operation also available during close-up playback.
Arrow pad () () () ()	Single-frame playback: display the next frame () / display the previous frame () / jump ahead 10 frames () / jump back 10 frames () Close-up playback: Changing the close-up position You can display the next frame () or the previous frame () during close-up playback by pressing the INFO button. Press the INFO button again to display a zoom frame and use ) ) ) ) to change its position. Index/My Clips/calendar playback: Highlight image
INFO button	View image info
 button	Select picture (P. 94)
Fn2 button	Protect picture (P. 93)
 button	Delete picture (P. 94)
 button	View menus (in calendar playback, press this button to exit to single-frame playback)

Index display/Calendar display

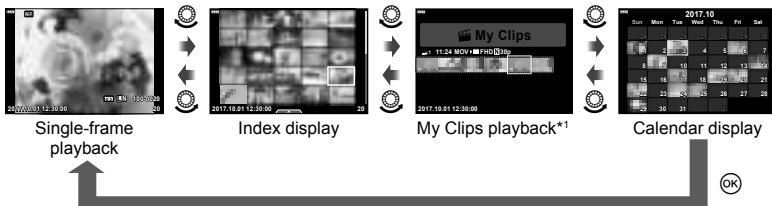
- In single-frame playback, rotate the rear dial to  for index playback. Rotate further for My Clips playback and further still for calendar playback.
- Turn the rear dial to Q to return to single-frame playback.



*1 If one or more My Clips have been created, it will be displayed here (P. 56).

- You can change the number of frames for index display.   [Settings] (P. 117)

Viewing still images



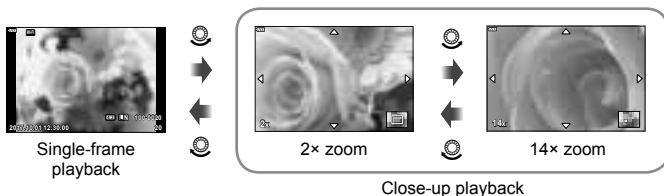

Close-up playback

In single-frame playback, turn the rear dial to Q to zoom in. Turn to  to return to single-frame playback.



Rotate

Choose whether to rotate photographs.

- 1 Play the photograph back and press the .
- 2 Select [Rotate] and press the .
- 3 Press  to rotate the image counterclockwise,  to rotate it clockwise; the image rotates each time the button is pressed.
 - Press the  button to save settings and exit.
 - The rotated image is saved in its current orientation.
 - Movies and protected images cannot be rotated.

Slideshow

This function displays images stored on the card one after another.

- 1 Press the **OK** button in the playback display.
- 2 Select **[Erase]** and press the **OK** button.



- 3 Adjust settings.

Start	Start the slideshow. Images are displayed in order, starting with the current picture.
BGM	Set [Happy Days] or [Off].
Slide	Set the type of data to be played back.
Slide Interval	Choose the length of time each slide is displayed from 2 to 10 seconds.
Movie Interval	Select [Full] to play back full length of each movie clip in the slideshow or [Short] to play back only the opening portion of each movie clip.

- 4 Select [Start] and press the **OK** button.
 - The slideshow will start.
 - Press **△▽** during the slideshow to adjust the overall volume of the camera speaker. Press **<>** while the volume adjustment indicator is displayed to adjust the balance between the sound recorded with the image or movie and background music.
 - Press the **OK** button to stop the slideshow.

BGM other than [Happy Days]

To use BGM other than [Happy Days], record data that you have downloaded from the Olympus website onto the card and select it as [BGM] in Step 3. Visit the following website for the download.

<http://support.olympus-imaging.com/bgmdownload/>

Watching movies

Select a movie and press the **OK** button to display the playback menu. Select [Play Movie] and press the **OK** button to begin playback. Fast-forward and rewind using **</>**. Press the **OK** button again to pause playback. While playback is paused, use **Δ** to view the first frame and **∇** to view the last frame. Use **</>** or the front dial (**⊙**) to view previous or next frame. Press the **MENU** button to end playback.

- Use **Δ ∇** to adjust the volume during movie playback.



For movies of 4 GB or larger

If the movie was automatically split into multiple files, pressing **OK** will display a menu containing the following options:

[Play from Beginning]:	Plays back a split movie all the way through
[Play Movie]:	Plays back files separately
[Delete entire ⊙]:	Deletes all parts of a split movie
[Erase]:	Deletes files separately

- We recommend using the latest version of OLYMPUS Viewer 3 to play back movies on a computer. Before launching the software for the first time, connect the camera to the computer.

Protecting images

Protect images from accidental deletion. Display an image you wish to protect and press **OK** to display the playback menu. Select [**⊖**] and press **OK**, and then press **Δ** or **∇** to protect the image. Protected images are shown by a **⊖** (protect) icon. Press **Δ** or **∇** to remove protection. You can also protect multiple selected images.

⊖ "Selecting images (**⊖**, Erase Selected, Share Order Selected)" (P. 94)

⊖ (protect) icon





- Formatting the card erases all data including protected images.

✎ Notes

- You can also protect the current picture by pressing the **Fn2** button. The **Fn2** button cannot be used to protect pictures when assigned the [Q] role. Choose a role other than [Q] before attempting to protect pictures (P. 85).



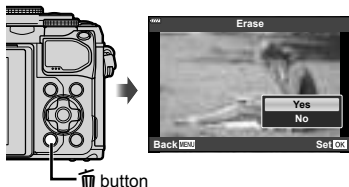

Erasing an image

Display an image you want to delete and press the  button. Select [Yes] and press the  button.



Selecting images (O, Erase Selected, Share Order Selected)







You can select multiple images for [O], [Erase Selected] or [Share Order Selected].

Press the  () button on the index display screen (P. 91) to select an image; a  icon will appear on the image. Press the  () button again to cancel the selection.

Press the  button to display the menu, and then select from [O], [Erase Selected] or [Share Order Selected].



Setting a transfer order on images (Share Order)

You can select images you want to transfer to a smartphone in advance. You can also browse the images included in the share order. When playing back images you want to transfer, press the  button to display the playback menu. After selecting [Share Order] and pressing the  button, press  or  to set a share order on an image and display . To cancel a share order, press  or .

You can select images you want to transfer in advance and set a share order all at once.  "Selecting images (O, Erase Selected, Share Order Selected)" (P. 94), "Transferring images to a smartphone" (P. 122)

- You can set a share order on 200 frames.
- Share orders cannot include RAW images.

Audio recording

Audio can be added to still images (up to 30 sec. long).

- 1 Display the image to which you want to add audio and press the **OK** button.
 - Audio recording is not available with protected images.
 - Audio recording is also available in the playback menu.
- 2 Select [**U**] and press the **OK** button.
 - To exit without adding audio, select [No].
- 3 Select [**U** Start] and press the **OK** button to begin recording.
- 4 Press the **OK** button to end recording.
 - Images recorded with audio are indicated by a **J** icon.
 - To delete recorded audio, select [Erase] in Step 3.

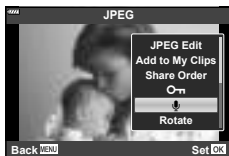

Audio Playback

If an audio recording is available for the current picture, pressing the **OK** button will display audio playback options. Highlight [Play **J**] and press the **OK** button to begin playback. To end playback, press the **OK** or **MENU** button. During playback, you can press **Δ** **∇** to raise or lower the volume.

Adding still pictures to My Clips (Add to My Clips)

You can also select still pictures and add them to My Clips.

Display the still picture you wish to add and press the **OK** button to display the menu. Select [Add to My Clips] and press the **OK** button. Using **Δ** **∇** **<** **>**, select My Clips and the order in which you wish to add the pictures, then press the **OK** button.

- RAW pictures are added to My Clips as low-resolution preview images.

Using the touch screen

You can use the touch screen to manipulate images.



■ Full-frame playback

Displaying the previous or next image

- Slide your finger to the left to view the next image, and right to view the previous image.







Magnify

- Lightly tap the screen to display the slider and .
- Slide the bar up or down to zoom in or out.
- Slide your finger to scroll the display when the picture is zoomed in.
- Tap  to display index playback. Tap  for calendar playback and My Clips playback.



■ Index/My Clips/Calendar playback

Displaying the previous or next page

- Slide your finger up to view the next page, and down to view the previous page.
- Tap  or  to switch the number of images displayed.  [Settings] (P. 110)
- Tap  several times to return to single-frame playback.

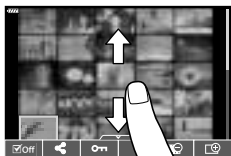





Viewing images

- Tap an image to view it full frame.

Selecting and protecting images

In single-frame playback, lightly tap the screen to display the touch menu. You can then perform the desired operation by tapping the icons in the touch menu.

	Select an image. You can select multiple images and delete them collectively.
	Images you want to share with a smartphone can be set.  "Setting a transfer order on images (Share Order)" (P. 94)
	Protects an image.

- Do not tap the display with your fingernails or other sharp objects.
- Gloves or monitor covers may interfere with touch screen operation.

4 Menu functions

Basic menu operations

The menus can be used to customize the camera for ease of use and include shooting and playback options not accessible via the live control, LV super control panel, or the like.

	Shooting setup and shooting settings (P. 98)
	Movie mode settings (P. 102)
	Playback and retouch options (P. 103)
	Customizing camera settings (P. 109)
	Camera setup (e.g., date and language) (P. 107)

4

Menu functions (Basic operations)

Functions that cannot be selected from menus

Some items may not be selectable from the menus when using the arrow pad.

- Items that cannot be set with the current shooting mode.
- Items that cannot be set because of an item that has already been set:
Settings such as picture mode are unavailable when the mode dial is rotated to .

1 Press the **MENU** button to display the menus.

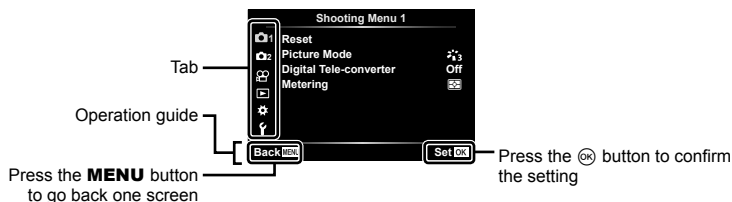

- A guide is displayed in 2 seconds after you select an option.
- Press the **INFO** button to view or hide guides.

2 Use Δ / ∇ to select a tab and press the **OK** button.

- The menu group tab appears when the Custom Menu is selected. Use Δ / ∇ to select the menu group and press the **OK** button.

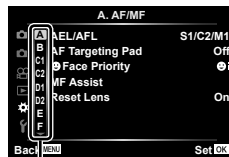

Menu group

- 3 Select an item using Δ ∇ and press the \odot button to display options for the selected item.

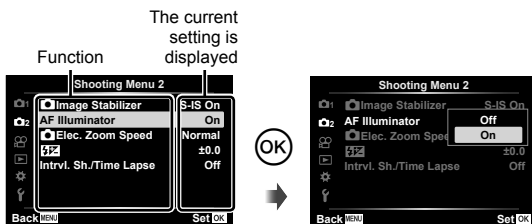

- 4 Use Δ ∇ to highlight an option and press the \odot button to select.
 - Press the **MENU** button repeatedly to exit the menu.

Notes

- For the default settings of each option, refer to “Defaults” (P. 148).

Using Shooting Menu 1/Shooting Menu 2



Shooting Menu 1

- 1 Reset (P. 98)
- 2 Picture Mode (P. 69, 99)
- Digital Tele-converter (P. 99)
- Metering (P. 80)

Shooting Menu 2

- 2 Image Stabilizer (P. 78)
- AF Illuminator (P. 99)
- Elec. Zoom Speed (P. 100)
- (P. 77)
- Intrvl. Sh./Time Lapse (P. 100)



Returning to default settings (Reset)

Camera settings can be easily restored to default settings.





- 1 Select [Reset] in Shooting Menu 1 and press the \odot button.
- 2 Highlight a reset option ([Full] or [Basic]) and press the \odot button.
 - To reset all settings except the time, date, and a few others, highlight [Full] and press the \odot button. “Defaults” (P. 148)
- 3 Select [Yes] and press the \odot button.

Processing options (Picture Mode)

You can make individual adjustments to contrast, sharpness and other parameters in [Picture Mode] (P. 69) settings. Changes to parameters are stored for each picture mode separately.



- 1 Select [Picture Mode] in  Shooting Menu 1 and press the  button.
 - The camera will display the picture mode available in the current shooting mode.



- 2 Select an option with   and press the  button.
 - Press  to set the detailed options for the selected picture mode. Detailed options are not available for some picture modes.
 - Changes to contrast have no effect at settings other than [Normal].

Digital Zoom (Digital Tele-converter)

Digital Tele-converter is used to zoom in beyond the current zoom ratio. The camera saves the center crop. The subject is nearly doubled in size.

- 1 Select [On] for [Digital Tele-converter] in  Shooting Menu 1.
- 2 The view in the monitor will be enlarged by a factor of two.
 - The subject will be recorded as it appears in the monitor.
 - Digital zoom is not available when multiple exposure, panorama, or keystone compensation is selected in  mode or when [Standard] is selected in movie mode.
 - When a RAW image is displayed, the area visible in the monitor is indicated by a frame.
 - AF target drops.
 -  is displayed on the monitor.

Improving Focus in Dark Surroundings (AF Illuminator)

The AF illuminator (AF assist lamp) lights to assist the focus operation in dark environments. Select [Off] to disable AF illuminator.

Choosing a Zoom Speed (📷 Elec. Zoom Speed)

Choose the speed at which electronic zoom lenses can be zoomed in or out using the zoom ring during still photography.

- 1 Highlight [📷 Elec. Zoom Speed] in **2** Shooting Menu 2 and press the **OK** button.
- 2 Select an option with **△ ▽** and press the **OK** button.

Shooting automatically with a fixed interval (Intrvl. Sh./Time Lapse)

You can set the camera to shoot automatically with a set time lapse. The shot frames can also be recorded as into a single movie. This setting is only available in **P/A/S/M** modes.

- 1 Highlight [Intrvl. Sh./Time Lapse] in **2** Shooting Menu 2 and press the **OK** button.



- 2 Select [On] and press the **▷**.
- 3 Adjust the following settings and press the **OK** button.

Number of Frames	Sets the number of frames to be shot.
Start Waiting Time	Sets waiting time before starting to shoot.
Interval Length	Sets interval between shots after shooting starts.
Time Lapse Movie	Sets recording format of frame sequence. [Off]: Records each frame as a still picture. [On]: Records each frame as a still picture and generates a single movie from the frame sequence.
Movie Settings	[Movie Resolution]: Choose a size for time lapse movies. [Frame Rate]: Choose a frame rate for time lapse movies.

- The starting and ending times shown in the display are intended as a guide only. The actual times may vary with shooting conditions.
- 4 The [Off]/[On] options will be displayed once more; confirm that [On] is highlighted and press the **OK** button again.
 - 5 Shoot.

- Frames are shot even if the image is not in focus after AF. If you wish to fix the focus position, shoot in MF.
- [Rec View] (P. 107) operates for 0.5 seconds.
- If either of the time before shooting, or shooting interval is set to 1 minute 31 seconds or longer, the monitor and camera power will turn off after 1 minute. 10 seconds before shooting, the power will automatically turn on again. When the monitor is off, press the shutter button to turn it on again.
- If the AF mode (P. 72) is set to [C-AF] or [C-AF+TR], it is automatically changed to [S-AF].
- Touch operations are disabled during time lapse shooting.
- Bulb, time, and composite photography are not available during time lapse photography.
- The flash will not work if the flash charging time is longer than the interval between shots.
- If any of still pictures are not recorded correctly, the time lapse movie will not be generated.
- If there is insufficient space on the card, the time lapse movie will not be recorded.
- Time lapse shooting will be canceled if any of the following is operated:
Mode dial, **MENU** button,  button, lens release button, or connecting the USB cable.
- If you turn off the camera, time lapse shooting will be canceled.
- If there is not enough charge left on the battery, the shooting may end partway through. Make sure the battery is charged enough before shooting.
- Movies recorded with [4K] selected for [Movie Settings] > [Movie Resolution] may not display on some computer systems. More information is available on the OLYMPUS website.

Using the Video Menu

Movie recording functions are set in the Video Menu.



Option	Description	
Movie	[Off]: Record movies without sound. [On]: Record movies with sound. [On]: Record movies with sound; wind noise reduction enabled.	52
Recording Volume	Adjust the sensitivity of the built-in microphone. Adjust the sensitivity using Δ ∇ while checking the peak sound level picked up by the microphone over the previous few seconds.	—
AF Mode	Choose the AF mode for movie recording.	72
Image Stabilizer	Sets image stabilization for movie recording.	78
Elec. Zoom Speed	Choose the speed at which electronic zoom lenses can be zoomed in or out using the zoom ring during movie recording.	—
Video Frame Rate	Choose the frame rate for movie recording.	74
Video Bit Rate	Choose the compression ratio for movie recording.	74

- Operation sounds of the lens and camera may be recorded in a movie. To prevent it from recording, reduce the operation sounds by setting [AF Mode] to [S-AF] or [MF], or by minimizing the button operations of the camera.
- Sound cannot be recorded in ^{ART} (Diorama) mode.
- When [Movie] is set to [Off], is displayed.

Using the Playback Menu

Playback Menu

 (P. 92)

 (P. 103)

Edit (P. 103)

Print Order (P. 130)

Reset Protect (P. 106)

Connection to Smartphone (P. 121)











Displaying images rotated ()





If set to [On], images in portrait orientation are automatically rotated to be displayed in the correct orientation on the playback display.

Editing still images (Edit)

Recorded images can be edited and saved as separate images.

- 1 Select [Edit] in the  Playback Menu and press the  button.
- 2 Use   to select [Sel. Image] and press the  button.
- 3 Use   to select the image to be edited and press the  button.
 - [RAW Data Edit] is displayed if a RAW image is selected, and [JPEG Edit] if a JPEG image is selected. For images recorded in RAW+JPEG format, both [RAW Data Edit] and [JPEG Edit] are displayed. Select the desired option from them.
- 4 Select [RAW Data Edit] or [JPEG Edit] and press the  button.



RAW Data Edit	Creates a JPEG copy of a RAW image according to the selected settings.	
	Current	The JPEG copy is processed using the current camera settings. Adjust the camera settings before choosing this option. Some settings such as exposure compensation are not applied.
	ART BKT	The image is edited using settings for the selected art filter.

JPEG Edit	<p>Choose from the following options: [Shadow Adj]: Brightens a dark backlit subject. [Redeye Fix]: Reduces the red-eye phenomenon due to flash shooting.</p> <p>[]: Trims an image. Use the front dial () or rear dial () to choose the size of the trimming and Δ ∇ \triangleleft \triangleright to specify the trimming position.</p>
	 <p>[Aspect]: Changes the aspect ratio of images from 4:3 (standard) to [3:2], [16:9], [1:1], or [3:4]. After changing the aspect ratio, use Δ ∇ \triangleleft \triangleright to specify the trimming position. [Black & White]: Creates black and white images. [Sepia]: Creates sepia-toned images. [Saturation]: Increases the vividness of images. Adjust the color saturation checking the image on the screen. []: Converts the image size to 1280 × 960, 640 × 480, or 320 × 240. Images with an aspect ratio other than 4:3 (standard) are converted to the closest image size. [e-Portrait]: Compensates the skin look for smoothness. Compensation cannot be applied in such a case that a face cannot be detected.</p>

5 When the settings are complete, press the  button.

- The settings are applied to the image.

6 Select [Yes] and press the  button.

- The edited image is stored in the card.
- Red-eye correction may not work depending on the image.
- Editing of a JPEG image is not possible in the following cases:
 - When an image is processed on a PC, when there is not enough space in the card memory, or when an image is recorded on another camera.
- The image cannot be resized () to the larger size than the original size.
- [] (trimming) and [Aspect] can only be used to edit images with an aspect ratio of 4:3 (standard).

Audio recording

Audio can be added to still images (up to 30sec. long).

This is the same function as [] during playback (P. 95).

Image overlay

Up to 3 frames of RAW images taken with the camera can be overlaid and saved as a separate image.

The image is saved with the record mode set at the time the image is saved. (If [RAW] is selected, the copy will be saved in [L+N+RAW] format.)

- 1 Select [Edit] in the Playback Menu and press the button.
- 2 Use $\Delta \nabla$ to select [Image Overlay] and press the button.
- 3 Select the number of images to be overlaid and press the button.
- 4 Use $\Delta \nabla \triangleleft \triangleright$ to select the RAW images and press the button to add them to the overlay.
 - The overlaid image will be displayed if images of the number specified in step 3 are selected.
- 5 Adjust the gain for each image to be overlaid.
 - Use $\triangleleft \triangleright$ to select an image and $\Delta \nabla$ to adjust gain.
 - Gain can be adjusted in the range 0.1–2.0. Check the results in the monitor.
- 6 Press the button to display the confirmation dialog. Select [Yes] and press the button.

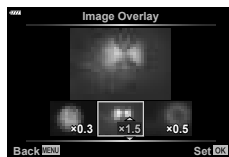
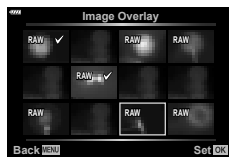

Notes



















- To overlay 4 or more frames, save the overlay image as a RAW file and use [Image Overlay] repeatedly.

Saving a still image from a movie (In-Movie Image Capture)

Save selected frames from 4K movies as still images.



- 1 Select [Edit] in the Playback Menu and press the button.
- 2 Use $\Delta \nabla$ to select [Sel. Image] and press the button.
- 3 Use $\triangleleft \triangleright$ to select a movie and press the button.
- 4 Select [Movie Edit] and press the button.
- 5 Use $\Delta \nabla$ to select [In-Movie Image Capture] and press the button.
- 6 Use $\triangleleft \triangleright$ to select a frame to be saved as a still image and press the button.
 - Use $\Delta \nabla$ or to skip multiple frames.

Trimming movies (Movie Trimming)

- 1 Select [Edit] in the  Playback Menu and press the  button.
- 2 Use   to select [Sel. Image] and press the  button.
- 3 Use   to select a movie and press the  button.
- 4 Select [Movie Edit] and press the  button.
- 5 Use   to select [Movie Trimming] and press the  button.
- 6 Select [Overwrite] or [New File] and press the  button.
 - If the image is protected, you cannot select [Overwrite].
- 7 Choose whether the section to be deleted begins with the first frame or ends with the last frame, using   to highlight the desired option and pressing the  button to select.
- 8 Use   to choose the section to be deleted.
 - The section to be deleted is shown in red.
- 9 Press the  button.
 - Editing is available with movies recorded using this camera.

Canceling all protections

Protections of multiple images can be canceled at a time.

- 1 Select [Reset Protect] in the  Playback Menu and press the  button.
- 2 Select [Yes] and press the  button.

Using the setup menu

Use the **⌘** Setup Menu to set the basic camera functions.

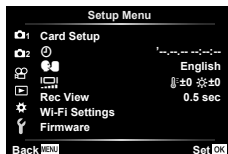





Option	Description	
Card Setup	Format the card and delete all images.	108
(Date/time setting)	Set the camera clock.	19
(Changing the display language)	You can change the language used for the on-screen display and error messages.	—
(Monitor brightness adjustment)	<p>You can adjust the brightness and color temperature of the monitor. Color temperature adjustment is only applied to the monitor display during playback. Use <D> to highlight (color temperature) or (brightness) and Δ/∇ to adjust the value.</p> <p>Press the INFO button to switch the saturation of the monitor between [Natural] and [Vivid] settings.</p>	—
Rec View	<p>Sets whether to display the captured image on the monitor after shooting, and the length of time for the display. This is useful for a brief check of the picture you have taken. You can shoot the next shot by pressing the shutter button halfway even while the captured image is displayed on the monitor.</p> <p>[0.3sec]–[20sec]: Sets the length of time (seconds) to display the captured image on the monitor.</p> <p>[Off]: The captured image is not displayed on the monitor.</p> <p>[Auto]: Displays the captured image, and then switches to playback mode. This is useful for erasing a picture after checking it.</p>	—
Wi-Fi Settings	Sets the wireless connection method for the camera to connect with smartphones that support wireless LAN connections.	123
Firmware	Displays the firmware versions of the camera and connected accessories. Check the versions when you inquire about the camera or accessories or when you download the software.	—

Formatting the card (Card Setup)

Cards must be formatted with this camera before first use or after being used with other cameras or computers.

All data stored on the card, including protected images, is erased when the card is formatted.



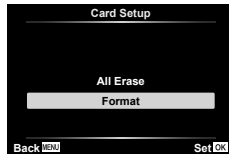

When formatting a used card, confirm there are no images that you still want to keep on the card.  “Usable cards” (P. 133)

- 1 Select [Card Setup] in the  Setup Menu and press the  button.
 - If there is data on the card, menu items appear. Select [Format] and press the  button.
- 2 Select [Yes] and press the  button.
 - Formatting is performed.



Deleting all images (Card Setup)

All images on a card can be deleted at a time. Protected images are not deleted.

- 1 Select [Card Setup] in the  Setup Menu and press the  button.
- 2 Select [All Erase] and press the  button.
- 3 Select [Yes] and press the  button.
 - All images are deleted.

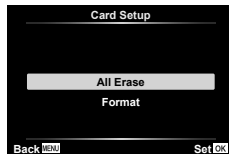

Using the custom menus

Camera settings can be customized using the **⚙ Custom Menu**.

Custom Menu

- A** AF/MF (P. 109)
- B** Button/Dial (P. 109)
- C1/C2** Disp/⬤/PC (P. 110)
- D1/D2** Exp/ISO/BULB (P. 111)
- E** ⚡ Custom (P. 112)
- F** ⬅️/WB/Color (P. 112)
- G** Record (P. 113)
- H** EVF (P. 114)
- I** 📷 Utility (P. 114)



A AF/MF

MENU → ⚙ → **A**

Option	Description	
AEL/AFL	Customize AF and AE lock.	115
AF Targeting Pad	If [On] is selected, the AF target can be positioned by tapping the monitor during viewfinder photography. Tap the monitor and slide your finger to position the AF target. <ul style="list-style-type: none">• When set to [On], drag operation can be disabled or enabled by double-tapping the monitor.• [AF Targeting Pad] can also be used with zoom frame AF (P. 87).	—
☺ Face Priority	You can select the face priority or eye priority AF mode.	62
MF Assist	When set to [On], you can automatically switch to zoom or peaking in manual focus mode by rotating the focus ring.	115
Reset Lens	When set to [Off], the focus position of the lens is not reset even when the power is turned off. When set to [On], the focus of power zoom lenses is also reset.	—

B Button/Dial

MENU → ⚙ → **B**

Option	Description	
Button Function	Choose the function assigned to the selected button.	85
Dial Function	You can change the function of the front dial and rear dial.	—

Option	Description	
Control Settings	For each shooting mode except movie, choose whether pressing the button displays live controls or LV super controls.	67, 68
/Info Settings	Choose the information displayed when the INFO button is pressed. [▶ Info]: Choose the information displayed in full frame playback. [LV-Info]: Choose the information displayed when the camera is in shooting mode. [⊠ Settings]: Choose the information displayed in index, "My Clips", and calendar playback.	116, 117
Live View Boost	Selecting [On] makes it easier to see poorly-lit subjects in the display. [Off]: Changes to settings such as exposure compensation are reflected in the display in the monitor. [On]: Changes to settings such as exposure compensation are not reflected in the display in the monitor; instead, brightness is adjusted to bring the display as close as possible to optimal exposure.	—
Flicker reduction	Reduce the effects of flicker under some kinds of lighting, including fluorescent lamps. When flicker is not reduced by the [Auto] setting, set to [50Hz] or [60Hz] in accordance with the commercial power frequency of the region where the camera is used.	—
Displayed Grid	Select to display a grid on the monitor.	—
Peaking Color	Choose the color of the outlines (red, yellow, white, or black) in the focus peaking display.	115

Option	Description	
(Beep sound)	When set to [Off], you can turn off the beep sound that is emitted when the focus locks by pressing the shutter button.	—
HDMI	[Output Size]: Selecting the digital video signal format for connecting to a TV via an HDMI cable. [HDMI Control]: Select [On] to allow the camera to be operated using remotes for TVs that support HDMI control. This option takes effect when pictures are displayed on a TV.	118
USB Mode	Choose a mode for connecting the camera to a computer or printer. Choose [Auto] to display USB mode options every time the camera is connected.	—



Option	Description	
Exposure Shift	Adjust correct exposure separately for each metering mode. <ul style="list-style-type: none"> This reduces the number of exposure compensation options available in the selected direction. The effects are not visible in the monitor. To make normal adjustments to the exposure, perform exposure compensation (P. 60). 	—
ISO-Auto Set	Choose the upper limit and default value used for ISO sensitivity when [Auto] is selected for ISO. [High Limit]: Choose the upper limit for auto ISO sensitivity selection. [Default]: Choose the default value for auto ISO sensitivity selection.	—
Noise Filter	Choose the amount of noise reduction performed at high ISO sensitivities.	—
Noise Reduct.	This function reduces the noise that is generated during long exposures. [Auto]: Noise reduction is performed at slow shutter speeds, or when the internal temperature of the camera has risen. [On]: Noise reduction is performed with every shot. [Off]: Noise reduction off. <ul style="list-style-type: none"> The time required for noise reduction is shown in the display. [Off] is selected automatically during sequential shooting. This function may not work effectively with some shooting conditions or subjects. 	48

Option	Description	
Bulb/Time Timer	Choose the maximum exposure for bulb and time photography.	49
Live Bulb	Choose the display interval during shooting. The number of update times is limited. The frequency drops at high ISO sensitivities. Choose [Off] to disable the display. Tap the monitor or press the shutter button halfway to refresh the display.	
Live Time	Choose the display interval during shooting. The number of update times is limited. The frequency drops at high ISO sensitivities. Choose [Off] to disable the display. Tap the monitor or press the shutter button halfway to refresh the display.	
Composite Settings	Set an exposure time to be the reference in composite photography.	50

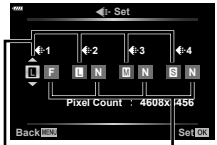
Option	Description	👉
⚡ X-Sync.	Choose the shutter speed used when the flash fires.	119
⚡ Slow Limit	Choose the slowest shutter speed available when a flash is used.	119
📷+📷	When set to [On], the exposure compensation value is added to the flash compensation value.	60, 77
⚡+WB	Adjust white balance for use with a flash.	—

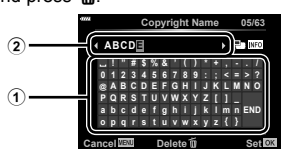
Option	Description	👉
⏪ Set	<p>You can select the JPEG image quality mode from combinations of three image sizes and four compression rates.</p> <ol style="list-style-type: none"> Use ◀▶ to select a combination ([⏪:1] – [⏪:4]) and use △▽ to change. Press the OK button. <div data-bbox="315 492 844 706" style="border: 1px solid gray; padding: 5px;">  <p style="text-align: center;">Image size Compression rate</p> </div>	73, 119
WB	Set the white balance. You can also fine-tune the white balance for each mode.	70, 79
WB AUTO Keep Warm Color	Select [On] to preserve “warm” colors in pictures taken under incandescent lighting.	—
Color Space	You can select a format to ensure that colors are correctly reproduced when shot images are regenerated on a monitor or using a printer.	84

Option	Description	☞
<p>File Name</p>	<p>[Auto]: Even when a new card is inserted, the file numbers are retained from the previous card. File numbering continues from the last number used or from the highest number available on the card.</p> <p>[Reset]: When you insert a new card, the folder numbers starts at 100 and the file name starts at 0001. If a card containing images is inserted, the file numbers start at the number following the highest file number on the card.</p>	<p>—</p>
<p>Edit Filename</p>	<p>Choose how image files are named by editing the portion of the filename highlighted below in gray.</p> <p>sRGB: Pmdd0000.jpg _____ Pmdd</p> <p>Adobe RGB: _mdd0000.jpg _____ mdd</p>	<p>—</p>
<p>Copyright Settings*</p>	<p>Add the names of the photographer and copyright holder to new photographs. Names can be up to 63 characters long.</p> <p>[Copyright Info.]: Select [On] to include the names of the photographer and copyright holder in the Exif data for new photographs.</p> <p>[Artist Name]: Enter the name of the photographer.</p> <p>[Copyright Name]: Enter the name of the copyright holder.</p> <div style="border: 1px solid gray; padding: 5px; margin: 10px 0;"> <p>1) Select characters from ① and press the OK button. The selected characters appear in ②.</p> <p>2) Repeat Step 1 to complete the name, then highlight [END] and press the OK button.</p> <ul style="list-style-type: none"> • To delete a character, press the INFO button to place the cursor in the name area ②, highlight the character, and press ⏏. </div> <div style="text-align: center; margin: 10px 0;">  </div> <p>* OLYMPUS does not accept liability for damages arising from disputes involving the use of [Copyright Settings]. Use at your own risk.</p>	<p>—</p>

Option	Description	
EVF Auto Switch	If [Off] is selected, the viewfinder will not turn on when you put your eye to the viewfinder. Use the  button to choose the display.	—
EVF Adjust	Adjust viewfinder brightness and hue. Brightness is automatically adjusted when [EVF Auto Luminance] is set to [On]. The contrast of the information display is also adjusted automatically.	—

Option	Description	 141
Pixel Mapping	The pixel mapping feature allows the camera to check and adjust the image pickup device and image processing functions.	141
Level Adjust	You can calibrate the angle of the level gauge. [Reset]: Resets adjusted values to the default settings. [Adjust]: Sets the current camera orientation as the 0 position.	—
Touchscreen Settings	Activate the touch screen. Choose [Off] to disable the touch screen.	—
Sleep	The camera will enter sleep (energy saving) mode if no operations are performed for the selected period. The camera can be reactivated by pressing the shutter button halfway.	—
Eye-Fi*	Enable or disable upload when using an Eye-Fi card. The setting can be changed when an Eye-Fi card is inserted.	—
Certification	Display certification icons.	—

- * Use the Eye-Fi card in compliance with the laws and regulations of the country where the camera is used. Onboard airplanes and in other locations in which the use of wireless devices is prohibited, remove the Eye-Fi card from the camera, or select [Off] for [Eye-Fi]. The camera does not support the “endless” Eye-Fi mode.

AEL/AFL

MENU → * → **A** → [AEL/AFL]

Autofocus and metering can be performed by pressing the button to which AEL/AFL has been assigned. Choose a mode for each focus mode.

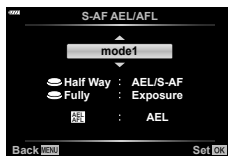

Assignments of AEL/AFL function

Mode		Shutter button function				AEL/AFL Button function	
		Half-press		Full press		When holding down AEL/AFL	
		Focus	Exposure	Focus	Exposure	Focus	Exposure
S-AF	mode1	S-AF	Locked	–	–	–	Locked
	mode2	S-AF	–	–	Locked	–	Locked
	mode3	–	Locked	–	–	S-AF	–
C-AF	mode1	C-AF start	Locked	Locked	–	–	Locked
	mode2	C-AF start	–	Locked	Locked	–	Locked
	mode3	–	Locked	Locked	–	C-AF start	–
	mode4	–	–	Locked	Locked	C-AF start	–
MF	mode1	–	Locked	–	–	–	Locked
	mode2	–	–	–	Locked	–	Locked
	mode3	–	Locked	–	–	S-AF	–

MF Assist

MENU → * → **A** → [MF Assist]

This is a focus assist function for MF. When the focus ring is rotated, the edge of the subject is enhanced or a portion of the screen display is magnified. When you stop operating the focus ring, the screen returns to the original display.

Magnify	Magnifies a portion of the screen. The portion to be magnified can be set in advance using AF target. "Setting the AF target" (P. 61)
Peaking	Displays clearly defined outlines with edge enhancement. You can choose the color of the outlines. [Peaking Color] (P. 110)

- When Peaking is in use, the edges of small subjects tend to be enhanced more strongly. This is no guarantee of accurate focusing.

Notes

- [Peaking] can be displayed using button operations. The display is switched every time the button is pressed. Assign the switching function to one of the buttons in advance using Button Function (P. 85).

Adding information displays

MENU → * → [C1] → [INFO] /Info Settings]

▶ Info (Playback information displays)

Use [▶ Info] to add the following playback information displays. The added displays are displayed by repeatedly pressing the **INFO** button during playback. You can also choose to not show displays that appear at the default setting.



Histogram display



Highlight & Shadow display



Light box display

- The Highlight & Shadow display shows overexposed areas in red, underexposed areas in blue.
- Use the light box display to compare two images side-by-side. Press the **OK** button to switch from one picture to the other.
- The base image is displayed on the right. Use the front dial to select an image and press the **OK** to move the image to the left. The image to be compared to the image on the left can be selected on the right. To choose a different base image, highlight the right frame and press the **OK**.
- To change the zoom ratio, turn the rear dial. Press the **Fn1** button and then **Δ ∇ < >** to scroll the zoomed-in area, and rotate the front dial to select between images.



LV-Info (Shooting information displays)

The histogram, Highlight & Shadow, and level gauge displays can be added to [LV-Info]. Choose [Custom 1] or [Custom 2] and select the displays you wish to add. The added displays are displayed by repeatedly pressing the **INFO** button during shooting. You can also choose to not show displays that appear at the default setting.

Settings (Index/calendar display)

You can change the number of frames to be displayed on the index display and set to not display the screens that are set to be displayed by default with [Settings]. Screens with a check can be selected on the playback screen using the rear dial.

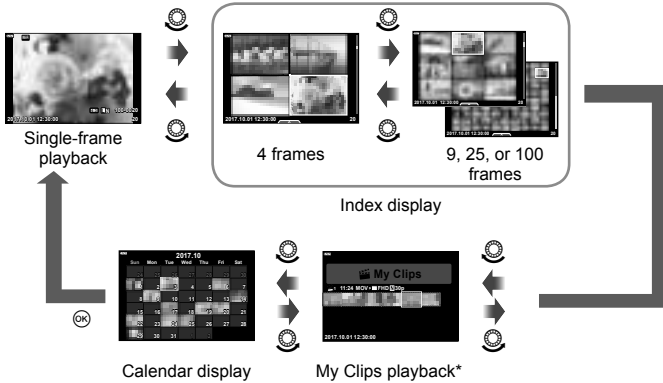

* If one or more My Clips have been created, it will be displayed here (P. 56).

Viewing camera images on TV

MENU → * → [Q] → [HDMI]

Use the separately sold cable with the camera to playback recorded images on your TV. This function is available during shooting. Connect the camera to an HD TV using an HDMI cable to view high-quality images on a TV screen.

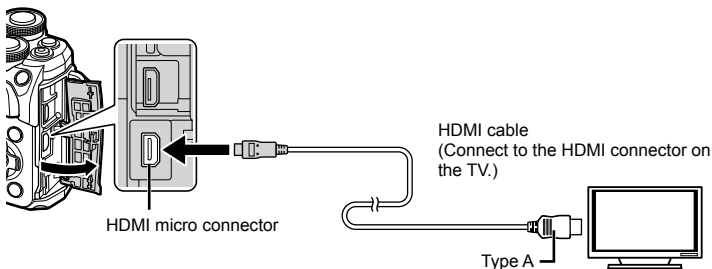

Connect the TV and camera and switch the input source of the TV.

- The camera monitor turns off when an HDMI cable is connected.
- For details on changing the input source of the TV, refer to the TV's instruction manual.
- Depending on the TV's settings, the displayed images and information may become cropped.
- If the camera is connected via an HDMI cable, you will be able to choose the digital video signal type. Choose a format that matches the input format selected with the TV.

4K	Priority is given to 4K HDMI output.
1080p	Priority is given to 1080p HDMI output.
720p	Priority is given to 720p HDMI output.
480p/576p	480p/576p HDMI output.

- Do not connect the camera to other HDMI output devices. Doing so may damage the camera.
- HDMI output is not performed while connected via USB to a computer or printer.
- When [4K] is selected, video output in shooting mode is [1080p].

Using the TV remote control

The camera can be operated by a TV remote control when connected to a TV that supports HDMI control. Select [On] for [HDMI Control]. When [On] is selected, camera controls can be used for playback only.

- You can operate the camera by following the operation guide displayed on the TV.
- During single-frame playback, you can display or hide the information display by pressing the "Red" button, and display or hide the index display by pressing the "Green" button.
- Some televisions may not support all features.

Shutter speeds when the flash fires

MENU → * → [] → [⚡ X-Sync.]/[⚡ Slow Limit]

You can set shutter speed conditions for when the flash fires.

Shooting mode	Flash firing shutter speed	Upper limit	Lower limit
P	The camera automatically sets the shutter speed.	[⚡ X-Sync.] setting* ¹	[⚡ Slow Limit] setting* ²
A			
S	The set shutter speed		No lower limit
M			

*1 1/200 seconds when using a separately sold external flash.

*2 Extends up to 60 seconds when slow synchronization is set.

Combinations of JPEG image sizes and compression rates

MENU → * → [] → [⏪ Set]

You can set the JPEG image quality by combining image size and compression rate.

Image size		Compression rate				Application
Name	Pixel Count	SF (Super Fine)	F (Fine)	N (Normal)	B (Basic)	
L (Large)	4608×3456	L SF	L F	L N	L B	Select for the print size
M (Middle)	3200×2400	M SF	M F	M N	M B	
S (Small)	1280×960	S SF	S F	S N	S B	For small prints and use on a website

By connecting to a smartphone through this camera's wireless LAN function and using the specified app, you can enjoy even more features during and after shooting.

Things you can do with the specified app, OLYMPUS Image Share (OI.Share)

- Camera image transfer to a smartphone
You can load images in the camera to a smartphone.
- Remote shooting from a smartphone
You can remotely operate the camera and shoot using a smartphone.
- Beautiful image processing
You can apply art filters and add stamps on images loaded to a smartphone.
- Addition of GPS tags to camera images
You can add GPS tags to images simply by transferring the GPS log saved on the smartphone to the camera.



For details, visit the address below:

<http://app.olympus-imaging.com/oishare/>

- Before using the wireless LAN function, read "Using the wireless LAN function" (P. 158).
- If using the wireless LAN function in a country outside the region where the camera was purchased, there is a risk that the camera will not conform to the wireless communication regulations of that country. Olympus will not be held responsible for any failure to meet such regulations.
- As with any wireless communication, there is always a risk of interception by a third party.
- The wireless LAN function on the camera cannot be used to connect to a home or public access point.
- The transmitting antenna is located inside the grip. Keep the antenna away from metal objects whenever possible.
- During wireless LAN connection, the battery will run down faster. If the battery is running low, the connection may be lost during a transfer.
- Connection may be difficult or slow in proximity to devices that generate magnetic fields, static electricity or radio waves, such as near microwaves, cordless telephone.

Connecting to a smartphone

Connect to a smartphone. Start the OI.Share App installed on your smartphone.

- 1 Select [Connection to Smartphone] in the  Playback Menu and press the  button.
 - You can also connect by tapping  in the monitor.
- 2 Following the guide displayed on the monitor, proceed with the Wi-Fi settings.
 - The SSID, password and QR code are displayed on the monitor.

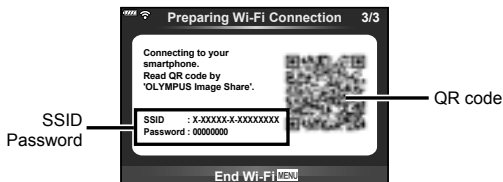

- 3 Start OI.Share on your smartphone, and read the QR code displayed on the camera monitor.
 - Connection will be performed automatically.
 - Some smartphones will need to be configured manually after reading the QR code. If the smartphone is connected to another Wi-Fi network or device, you may need to change the network selected in the smartphone's Setting app to the camera SSID.
 - If you are unable to read the QR code, enter the SSID and password in the Wi-Fi settings of your smartphone to connect. For how to access the Wi-Fi settings on your smartphone, please see your smartphone operating instructions.
- 4 To end the connection, press **MENU** on the camera or tap [End Wi-Fi] on the monitor screen.
 - You can also end the connection with OI.Share or by turning off your camera.

Transferring images to a smartphone

You can select images in the camera and load them to a smartphone. You can also use the camera to select images you want to share in advance.  “Setting a transfer order on images (Share Order)” (P. 94)

- 1 Connect the camera to a smartphone (P. 121).
 - You can also connect by tapping  in the monitor.

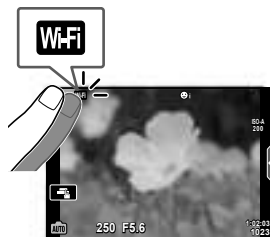

- 2 Launch OI.Share and tap the Image Transfer button.
 - The images in the camera are displayed in a list.
- 3 Select the pictures you want to transfer and tap the Save button.
 - When saving is completed, you can turn off the camera from the smartphone.

Shooting remotely with a smartphone

You can shoot remotely by operating the camera with a smartphone. This is available only in [Private] (P. 123).

- 1 Start [Connection to Smartphone] on the camera.
 - You can also connect by tapping  in the monitor.
 - 2 Launch OI.Share and tap the Remote button.
 - 3 Tap the shutter button to shoot.
 - The image taken is saved on the memory card in the camera.
- Available shooting options are partially limited.

Adding position information to images

You can add GPS tags to images that were taken while the GPS log was saving by transferring the GPS log saved on the smartphone to the camera.

This is available only in [Private].

- 1** Before beginning to shoot, launch OI.Share and turn on the switch on the Add Location button to begin saving the GPS log.
 - Before beginning to save the GPS log, the camera must be connected to OI.Share once to synchronize the time.
 - You can use the phone or other apps while the GPS log is saving. Do not terminate OI.Share.
- 2** When shooting is complete, turn off the switch on the Add Location button. Saving the GPS log is complete.
- 3** Start [Connection to Smartphone] on the camera.
 - You can also connect by tapping **WiFi** in the monitor.
- 4** Transfer the saved GPS log to the camera using OI.Share.
 - GPS tags are added to the images in the memory card based on the transferred GPS log.
 -  is displayed on images to which position information has been added.
 - Addition of location information can only be used with smartphones that have a GPS function.
 - Position information cannot be added to movies.

Changing the connection method

There are two ways to connect to a smartphone. With [Private] the same settings are used to connect every time. With [One-Time] different settings are used each time. You may find it convenient to use [Private] when connecting to your own smartphone and [One-Time] when transferring images to a friend's smartphone etc. The default setting is [Private].

- 1** Select [Wi-Fi Settings] in the **f** Setup Menu and press the **OK** button.
- 2** Select [Wi-Fi Connect Settings] and press **▷**.
- 3** Select the wireless LAN connection method and press the **OK** button.
 - [Private]: Connect to one smartphone (connects automatically using the settings after the initial connection). All OI.Share functions are available.
 - [One-Time]: Connect to multiple smartphones (connects using different connection settings each time). Only OI.Share's image transfer function is available. You can view only images that are set for share order using the camera.
 - [Select]: Select which method to use each time.
 - [Off]: The Wi-Fi function is turned off.

Changing the password

Change the password used for [Private].

- 1 Select [Wi-Fi Settings] in the **f** Setup Menu and press the **OK** button.
- 2 Select [Private Password] and press **▷**.
- 3 Follow the operation guide and press the **⊙** button.
 - A new password will be set.

Cancelling a share order

Cancel share orders that are set on images.

- 1 Select [Wi-Fi Settings] in the **f** Setup Menu and press the **OK** button.
- 2 Select [Reset share Order] and press **▷**.
- 3 Select [Yes] and press the **OK** button.

Initializing wireless LAN settings

Initializes content of [Wi-Fi Connect Settings].

- 1 Select [Wi-Fi Settings] in the **f** Setup Menu and press the **OK** button.
- 2 Select [Reset Wi-Fi Settings] and press **▷**.
- 3 Select [Yes] and press the **OK** button.

Connecting the camera to a computer

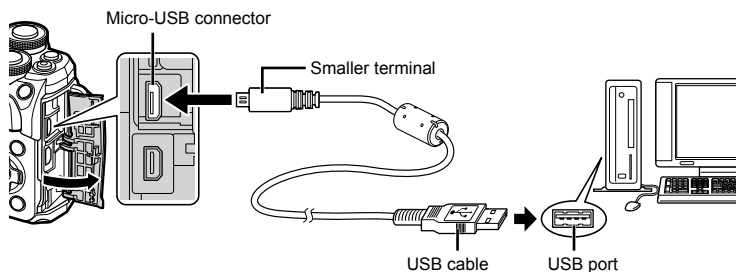

- When the camera is turned on, a dialog should be displayed in the monitor prompting you to choose a host. If it is not, select [Auto] for [USB Mode] (P. 110) in the camera custom menus.
- If nothing is displayed on the camera screen even after connecting the camera to the computer, the battery may be exhausted. Use a full-charged battery.

Copying pictures to a computer

The following operating systems are compatible with the USB connection:

Windows: Windows 7 SP1/Windows 8/Windows 8.1/Windows 10

Mac: OS X v10.8-v10.11/macOS v10.12

- 1 Turn the camera off and connect it to the computer.
 - The location of the USB port varies with the computer. For details, refer to your computer's manual.
- 2 Turn on the camera.
 - The selection screen for the USB connection is displayed.
- 3 Press Δ ∇ to select [Storage]. Press the OK button.

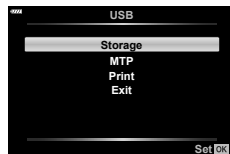

4 The computer recognizes the camera as a new device.

- If you are using Windows Photo Gallery, choose [MTP] in Step 3.
- Data transfer is not guaranteed in the following environments, even if your computer is equipped with a USB port.
 - Computers with a USB port added by means of an extension card, etc., computers without a factory-installed OS, or home-built computers
- Camera controls cannot be used while the camera is connected to a computer.
- If the dialog shown in Step 2 is not displayed when the camera is connected to a computer, select [Auto] for [USB Mode] (P. 110) in the camera custom menus.

Installing the PC software

The photographs and movies you have shot with your camera can be transferred to a computer and viewed, edited, and organized using the OLYMPUS Viewer 3 offered by OLYMPUS.

- To install OLYMPUS Viewer 3, download it from <http://support.olympus-imaging.com/ov3download/> and follow the on-screen instructions.
- Visit the website above for system requirements and installation instructions.
- You will be required to enter the product serial number prior to download.

Installing the OLYMPUS Digital Camera Updater

Camera firmware updates can only be performed using the OLYMPUS Digital Camera Updater. Download the updater from the website below and install it according to the on-screen instructions.

<http://oup.olympus-imaging.com/ou1download/index/>

User Registration

Visit the OLYMPUS website for information on registering your OLYMPUS products.

Direct printing (PictBridge)

By connecting the camera to a PictBridge-compatible printer with the USB cable, you can print out recorded pictures directly.

- 1 Connect the camera to the printer using the supplied USB cable and turn the camera on.

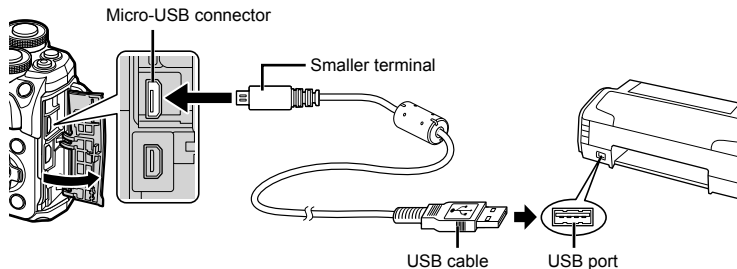

- Use a fully charged battery for printing.
- When the camera is turned on, a dialog should be displayed in the monitor prompting you to choose a host. If it is not, select [Auto] for [USB Mode] (P. 110) in the camera custom menus.

- 2 Use Δ ∇ to select [Print].

- [One Moment] will be displayed, followed by a print-mode selection dialog.
- If the screen is not displayed after a few minutes, disconnect the USB cable and start again from Step 1.

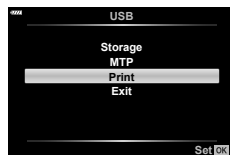

Proceed to “Custom printing” (P. 128)

- RAW images and movies cannot be printed.

Easy printing

Use the camera to display the picture you wish to print before connecting the printer via the USB cable.

- 1 Use \triangleleft and \triangleright to display the pictures you want to print on the camera.
- 2 Press \triangleright .
 - The picture selection screen appears when printing is completed. To print another picture, use \triangleleft and \triangleright to select the image and press the OK button.
 - To exit, unplug the USB cable from the camera while the picture selection screen is displayed.



Custom printing

- 1 Connect the camera to the printer using the supplied USB cable and turn the camera on.
 - When the camera is turned on, a dialog should be displayed in the monitor prompting you to choose a host. If it is not, select [Auto] for [USB Mode] (P. 110) in the camera custom menus.
- 2 Follow the operation guide to set a print option.

Selecting the print mode

Select the type of printing (print mode). The available print modes are as shown below.

Print	Prints selected pictures.
All Print	Prints all the pictures stored in the card and makes one print for each picture.
Multi Print	Prints multiple copies of one image in separate frames on a single sheet.
All Index	Prints an index of all the pictures stored in the card.
Print Order	Prints according to the print reservation you made. If there is no picture with print reservation, this is not available.

Setting the print paper items

This setting varies with the type of printer. If only the printer's STANDARD setting is available, you cannot change the setting.

Size	Sets the paper size that the printer supports.
Borderless	Selects whether the picture is printed on the entire page or inside a blank frame.
Pics/Sheet	Selects the number of pictures per sheet. Displayed when you have selected [Multi Print].

Selecting pictures you want to print

Select pictures you want to print. The selected pictures can be printed later (single-frame reservation) or the picture you are displaying can be printed right away.



Print OK	Prints the currently displayed picture. If there is a picture that [Single Print ▲] reservation has already been applied to, only that reserved picture will be printed.
Single Print ▲	Applies print reservation to the currently displayed picture. If you want to apply reservation to other pictures after applying [Single Print ▲], use <D> to select them.
More ▼	Sets the number of prints and other items for the currently displayed picture, and whether or not to print it. For operation, refer to "Setting printing data" in the next section.

Setting printing data

Select whether to print printing data such as the date and time or file name on the picture when printing. When the print mode is set to [All Print], select [Option Set].

	Sets the number of prints.
Date	Prints the date and time recorded on the picture.
File Name	Prints the file name recorded on the picture.
	Trims the picture for printing. Use the front dial (⊙) to choose the crop size and Δ ∇ <D> to specify the crop position.

- 3** Once you have set the pictures for printing and printing data, select [Print], then press the (OK) button.

- To stop and cancel printing, press the (OK) button. To resume printing, select [Continue].

■ Cancelling printing

To cancel printing, highlight [Cancel] and press the (OK) button. Note that any changes to the print order will be lost; to cancel printing and return to the previous step, where you can make changes to the current print order, press **MENU**.

Print order (DPOF)

You can save digital “print orders” to the memory card listing the pictures to be printed and the number of copies of each print. You can then have the pictures printed at a print shop that supports DPOF or print the pictures yourself by connecting the camera directly to a DPOF printer. A memory card is required when creating a print order.

Creating a print order

- 1 Press the **OK** button during playback and select [**Print Order**].
- 2 Select [**Print**] or [**Print ALL**] and press the **OK** button.

Individual picture

Press **<>** to select the frame that you want to set as print reservation, then press **Δ ∇** to set the number of prints.

- To set print reservation for several pictures, repeat this step. Press the **OK** button when all the desired pictures have been selected.

All pictures

Select [**Print ALL**] and press the **OK** button.

- 3 Select the date and time format and press the **OK** button.

No	The pictures are printed without the date and time.
Date	The pictures are printed with the shooting date.
Time	The pictures are printed with the shooting time.

- When printing images, the setting cannot be changed between the images.

- 4 Select [**Set**] and press the **OK** button.

- The camera cannot be used to modify print orders created with other devices. Creating a new print order deletes any existing print orders created with other devices.
- Print orders cannot include RAW images or movies.

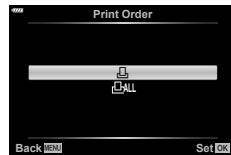

Removing all or selected pictures from the print order

You can reset all print reservation data or just the data for selected pictures.

- 1 Press the **OK** button during playback and select [**Print Order**].
- 2 Select [**Print Order**] and press the **OK** button.
 - To remove all pictures from the print order, select [Reset] and press the **OK** button. To exit without removing all pictures, select [Keep] and press the **OK** button.
- 3 Press **Left/Right** to select images you wish to remove from the print order.
 - Use **Down** to set the number of prints to 0. Press the **OK** button once you have removed all the desired pictures from the print order.
- 4 Select the date and time format and press the **OK** button.
 - This setting is applied to all frames with print reservation data.
- 5 Select [Set] and press the **OK** button.

7 Cautions

Battery and charger

- The camera uses a single Olympus lithium-ion battery. Never use any battery other than genuine OLYMPUS batteries.
- The camera's power consumption varies widely with usage and other conditions.
- As the following consume a lot of power even without shooting, the battery will be drained quickly.
 - Performing auto focus repeatedly by pressing the shutter button halfway in shooting mode.
 - Displaying images on the monitor for a prolonged period.
 - When connected to a computer or printer.
- When using a drained battery, the camera may turn off without the low battery warning being displayed.
- The battery will not be fully charged at the time of purchase. Charge the battery using the provided charger before use.
- The normal charging time using the provided charger is approximately 3 hours 30 minutes (estimated).
- Do not attempt to use chargers not specifically designated for use with the supplied battery, or to use batteries not specifically designated for use with the supplied charger.
- There is a risk of explosion if the battery is replaced with the incorrect battery type.
- Dispose of the used battery following the instructions "CAUTION" (P. 157) in the instruction manual.

Using your charger abroad

- The charger can be used in most home electrical sources within the range of 100V to 240 V AC (50/60 Hz) around the world. However, depending on the country or area you are in, the AC wall outlet may be shaped differently and the charger may require a plug adapter to match the wall outlet.
- Do not use commercially available travel adapters as the charger may malfunction.

Usable cards

In this manual, all storage devices are referred to as “cards.” The following types of SD memory card (commercially available) can be used with this camera: SD, SDHC, SDXC, and Eye-Fi. For the latest information, please visit the Olympus website.



SD card write protect switch

The SD card body has a write protect switch. Setting the switch to “LOCK” prevents data being written to the card. Return the switch to the unlock position enable writing.

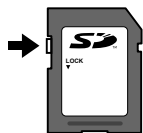

- The data in the card will not be erased completely even after formatting the card or deleting the data. When discarding, destroy the card to prevent leakage of personal information.
- Use the Eye-Fi card in compliance with the laws and regulations of the country where the camera is used. Remove the Eye-Fi card from the camera or disable the card functions in airplanes and other locations where use is prohibited.  [Eye-Fi] (P. 114)
- The Eye-Fi card may become hot during use.
- When using an Eye-Fi card, the battery may run out faster.
- When using an Eye-Fi card, the camera may function more slowly.
- Using an Eye-Fi card may interfere with clip recording. Please turn off the card function in this case.

Record mode and file size/number of storable still pictures

The file size in the table is approximate for files with a 4:3 aspect ratio.

Record mode	Image size (Pixel Count)	Compression	File format	File size (MB)	Number of storable still pictures*
RAW	4608×3456	Loss-less compression	ORF	Approx. 17.3	426
L SF		1/2.7	JPEG	Approx. 10.8	663
L F		1/4		Approx. 7.5	972
L N		1/8		Approx. 3.5	1891
L B		1/12		Approx. 2.4	2741
M SF	3200×2400	1/2.7		Approx. 5.6	1348
M F		1/4		Approx. 3.4	1951
M N		1/8		Approx. 1.7	3696
M B		1/12		Approx. 1.2	5191
S SF	1280×960	1/2.7		Approx. 0.9	6777
S F		1/4		Approx. 0.6	9036
S N		1/8	Approx. 0.4	14352	
S B		1/12	Approx. 0.3	17428	

* Assumes a 8GB SD card.

- The number of storable still pictures may change according to the subject, whether or not print reservations have been made, and other factors. In certain instances, the number of storable still pictures displayed on the monitor will not change even when you take pictures or erase stored images.
- The actual file size varies according to the subject.
- The maximum number of storable still pictures displayed on the monitor is 9999.
- For the available recording time for movies, see the Olympus website.

Interchangeable lenses

Choose a lens according to the scene and your creative intent. Use lenses designed exclusively for the Micro Four Thirds system and bearing the M.ZUIKO DIGITAL label or the symbol shown at right. With an adapter, you can also use Four Thirds System and OM System lenses. The optional adapter is required.



- When you attach or remove the body cap and lens from the camera, keep the lens mount on the camera pointed downward. This helps prevent dust and other foreign matter from getting inside the camera.
- Do not remove the body cap or attach the lens in dusty places.
- Do not point the lens attached to the camera toward the sun. This may cause the camera to malfunction or even ignite due to the magnifying effect of sunlight focusing through the lens.
- Be careful not to lose the body cap and rear cap.
- Attach the body cap to the camera to prevent dust from getting inside when no lens is attached.

■ Lens and camera combinations

Lens	Camera	Attachment	AF	Metering
Micro Four Thirds system lens	Micro Four Thirds system camera	Yes	Yes	Yes
Four Thirds system lens		Attachment possible with mount adapter	Yes*1	Yes
OM System lenses			No	Yes*2
Micro Four Thirds system lens	Four Thirds System Camera	No	No	No

*1 AF is not operational when recording movies.

*2 Accurate metering is not possible.

External flash units designated for use with this camera

With this camera, you can use one of the separately sold external flash units to achieve a flash suited to your needs. The external flashes communicate with the camera, allowing you to control the camera's flash modes with various available flash control modes, such as TTL-AUTO and Super FP flash. An external flash unit specified for use with this camera can be mounted on the camera by attaching it to the camera's hot shoe. You can also attach the flash to the flash bracket on the camera using the bracket cable (optional). Refer to the documentation provided with the external flash units as well.

The upper limit of the shutter speed is 1/200 sec. when using a flash.

Functions available with external flash units

Optional flash	Flash control mode	GN (Guide number) (ISO100)
FL-900R	TTL-AUTO, AUTO, MANUAL, FP TTL AUTO, FP MANUAL, MULTI, RC, SL AUTO, SL MANUAL	GN58 (200 mm ^{*1})
FL-600R	TTL-AUTO, AUTO, MANUAL, FP TTL AUTO, FP MANUAL	GN36 (85 mm ^{*1}) GN20 (24 mm ^{*1})
FL-300R	TTL-AUTO, MANUAL	GN20 (28 mm ^{*1})
FL-14	TTL-AUTO, AUTO, MANUAL	GN14 (28 mm ^{*1})
STF-8	TTL-AUTO, MANUAL	GN8.5

*1 The focal length of the lens that can be used (Calculated based on 35 mm film camera).

Other external flash units

Note the following when using a third-party flash unit mounted on the camera hot shoe:

- Using obsolete flash units that apply currents of more than about 250 V to the X-contact will damage the camera.
- Connecting flash units with signal contacts that do not conform to Olympus specifications may damage the camera.
- Set the Shooting mode to **M**, set the shutter speed to a value no higher than flash synchronous speed, and set ISO sensitivity to a setting other than [AUTO].
- Flash control can only be performed by manually setting the flash to the ISO sensitivity and aperture values selected with the camera. Flash brightness can be adjusted by adjusting either ISO sensitivity or aperture.
- Use a flash with an angle of illumination suited to the lens. Angle of illumination is usually expressed using 35-mm format equivalent focal lengths.

Principal Accessories

Converter lenses

Converter lenses attach to the camera lens for quick and easy fish-eye or macro photography. See the OLYMPUS website for information on the lenses that can be used.

Eyecup (EP-16)

You can switch to a large-size eyecup.

Removal

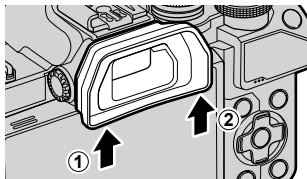

System chart

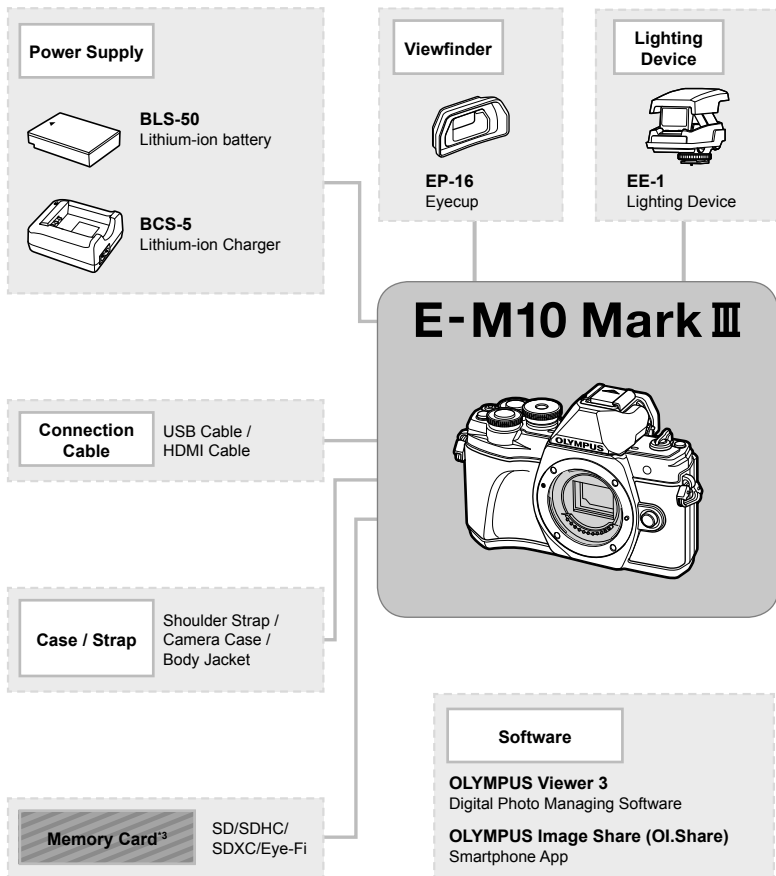

 : E-M10 Mark III compatible products

 : Commercially available products

For the latest information, please visit the Olympus website.

*1 Not all lenses can be used with adapter. For details, refer to the Olympus Official Web Site. Also, please note that manufacture of OM System Lenses has been discontinued.

*2 For compatible lens, refer to the Olympus Official Web Site.

*3 Use the Eye-Fi card in compliance with the laws and regulations of the country where the camera is used.

Lens

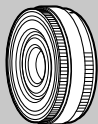

M.ZUIKO DIGITAL ED 8mm f1.8 Fisheye PRO
 M.ZUIKO DIGITAL ED 12mm f2.0
 M.ZUIKO DIGITAL 17mm f1.8
 M.ZUIKO DIGITAL 17mm f2.8
 M.ZUIKO DIGITAL 25mm f1.8
 M.ZUIKO DIGITAL 45mm f1.8
 M.ZUIKO DIGITAL ED 25mm f1.2 PRO
 M.ZUIKO DIGITAL ED 30mm f3.5 Macro
 M.ZUIKO DIGITAL ED 60mm f2.8 Macro
 M.ZUIKO DIGITAL ED 75mm f1.8
 M.ZUIKO DIGITAL ED 7-14mm f2.8 PRO
 M.ZUIKO DIGITAL ED 9-18mm f4.0-5.6
 M.ZUIKO DIGITAL ED 12-40mm f2.8 PRO
 M.ZUIKO DIGITAL ED 12-50mm f3.5-6.3 EZ
 M.ZUIKO DIGITAL ED 12-100mm f4.0 IS PRO
 M.ZUIKO DIGITAL ED 14-42mm f3.5-5.6 EZ
 M.ZUIKO DIGITAL 14-42mm f3.5-5.6 II R
 M.ZUIKO DIGITAL ED 14-150mm f4.0-5.6 II
 M.ZUIKO DIGITAL ED 40-150mm f4.0-5.6 R
 M.ZUIKO DIGITAL ED 40-150mm f2.8 PRO
 M.ZUIKO DIGITAL ED 75-300mm f4.8-6.7 II
 M.ZUIKO DIGITAL ED 300mm f4.0 IS PRO



MMF-2/MMF-3¹
 Four Thirds Adapter



MF-2¹
 OM Adapter 2



BCL-1580/BCL-0980
 Body Cap Lens



Four Thirds System Lenses

OM System Lenses

Converter Lens²

FCON-P01
 Fisheye

WCON-P01
 Wide

MCON-P01
 Macro

MCON-P02
 Macro

MC-14
 Teleconverter

Flash

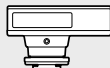

FL-14
 Electronic Flash



FL-900R
 Electronic Flash



FL-300R
 Electronic Flash



FL-600R
 Electronic Flash

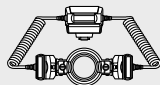

STF-8
 Macro Flash

Cleaning and storing the camera

Cleaning the camera

Turn off the camera and remove the battery before cleaning the camera.

- Do not use strong solvents such as benzene or alcohol, or a chemically treated cloth.

Exterior:

- Wipe gently with a soft cloth. If the camera is very dirty, soak the cloth in mild soapy water and wring well. Wipe the camera with the damp cloth and then dry it with a dry cloth. If you have used the camera at the beach, use a cloth soaked in clean water and well wrung.

Monitor:

- Wipe gently with a soft cloth.

Lens:

- Blow dust off the lens with a commercially available blower. For the lens, wipe gently with a lens cleaning paper.

Storage

- When not using the camera for a prolonged period, remove the battery and card. Store the camera in a cool, dry place that is well ventilated.
- Insert the battery periodically and test the camera's functions.
- Remove dust and other foreign matter from the body and rear caps before attaching them.
- Attach the body cap to the camera to prevent dust from getting inside when no lens is attached. Be sure to replace the front and rear lens caps before putting the lens away.
- Clean the camera after use.
- Do not store with insect repellent.
- Avoid storing the camera in places where chemicals are treated, in order to protect the camera from corrosion.
- Mold may form on the lens surface if the lens is left dirty.
- Check each part of the camera before use if it has not been used for a long time. Before taking important pictures, be sure to take a test shot and check that the camera works properly.

Cleaning and checking the image pickup device

This camera incorporates a dust reduction function to keep dust from getting on the image pickup device and to remove any dust or dirt from the image pickup device surface with ultrasonic vibrations. The dust reduction function operates when the camera is turned on.

The dust reduction function operates at the same time as the pixel mapping, which checks the image pickup device and image processing circuitry. Since dust reduction is activated every time the camera's power is turned on, the camera should be held upright for the dust reduction function to be effective.

Pixel Mapping - Checking the image processing functions

The pixel mapping feature allows the camera to check and adjust the image pickup device and image processing functions. Before using the pixel mapping function to ensure that it operates correctly, wait for 1 minute or longer immediately after shooting or playback.

- 1** In Custom Menu **1**, select [Pixel Mapping] (P. 114).
- 2** Press **▶**, then press the **OK** button.
 - The [Busy] bar is displayed when pixel mapping is in progress. When pixel mapping is finished, the menu is restored.
 - If you accidentally turn the camera off during pixel mapping, start again from Step 1.

Shooting tips and information

The camera does not turn on even when a battery is loaded

The battery is not fully charged

- Charge the battery with the charger.

The battery is temporarily unable to function because of the cold

- Battery performance drops at low temperatures. Remove the battery and warm it by putting it in your pocket for a while.

No picture is taken when the shutter button is pressed

The camera has turned off automatically

- The camera automatically enters sleep mode to reduce the drain on the battery if no operations are performed for a set period of time.  [Sleep] (P. 114)
Press the shutter button halfway to exit the sleep mode.

The camera will turn off automatically if no operations are performed for an additional 4 hours.

The flash is charging

- On the monitor, the  mark blinks when charging is in progress. Wait for the blinking to stop, then press the shutter button.

Unable to focus

- The camera cannot focus on subjects that are too close to the camera or that are not suited to autofocus (the AF confirmation mark will blink in the monitor). Increase the distance to the subject or focus on a high contrast object at the same distance from the camera as your main subject, compose the shot, and shoot.

Subjects that are difficult to focus on

It may be difficult to focus with auto focus in the following situations.

AF confirmation mark is blinking. These subjects are not focused.



Subject with low contrast



Excessively bright light in center of frame

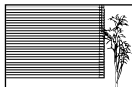

Subject containing no vertical lines

AF confirmation mark lights up but the subject is not focused.



Subjects at different distances

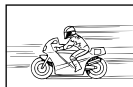

Fast-moving subject



Subject not inside AF area

Noise reduction is activated

- When shooting night scenes, shutter speeds are slower and noise tends to appear in images. The camera activates the noise-reduction process after shooting at slow shutter speeds. During which, shooting is not allowed. You can set [Noise Reduct.] to [Off].
🔍 [Noise Reduct.] (P. 111)

The number of AF targets is reduced

The size and number of the AF targets changes with the aspect ratio (P. 73), the AF target mode (P. 61), and the option selected for [Digital Tele-converter] (P. 99).

The date and time has not been set

The camera is used with the settings at the time of purchase

- The date and time of the camera is not set when purchased. Set the date and time before using the camera. 🔍 "Setting the date/time" (P. 19)

The battery has been removed from the camera

- The date and time settings will be returned to the factory default settings if the camera is left without the battery for approximately 1 day. The settings will be canceled more quickly if the battery was only loaded in the camera for a short time before being removed. Before taking important pictures, check that the date and time settings are correct.

Set functions are restored to their factory default settings

When you rotate the mode dial or turn off the power in a shooting mode other than **P**, **A**, **S**, or **M**, functions with changes made to their settings are restored to the factory default settings.

Image taken appears whitish

This may occur when the picture is taken in backlight or semi-backlight conditions. This is due to a phenomenon called flare or ghosting. As far as possible, consider a composition where strong light source is not taken in the picture. Flare may occur even when a light source is not present in the picture. Use a lens hood to shade the lens from the light source. If a lens hood does not have effect, use your hand to shade the lens from the light.

🔍 "Interchangeable lenses" (P. 135)

Unknown bright dot(s) appear on the subject in the picture taken

This may be due to stuck pixel(s) on the image pickup device. Perform [Pixel Mapping].

If the problem persists, repeat pixel mapping a few times. 🔍 "Pixel Mapping - Checking the image processing functions" (P. 141)

The subject appears distorted

The following functions use an electronic shutter:

movie recording (P. 52)/the **SCN** mode “silent” (P. 29) and “multi-focus shot” (P. 29) options/the **AP** mode “silent” (P. 37) and “focus bracketing” (P. 41) options



This may cause distortion if the subject is moving rapidly or the camera is moved abruptly. Avoid moving the camera abruptly during shooting or use standard sequential shooting.

Lines appear in photographs

The following functions use an electronic shutter, which may result in lines due to flicker and other phenomena associated with fluorescent and LED lighting, an effect that can sometimes be reduced by choosing slower shutter speeds:

movie recording (P. 52)/the **SCN** mode “silent” (P. 29) and “multi-focus shot” (P. 29) options/the **AP** mode “silent” (P. 37) and “focus bracketing” (P. 41) options

I want to turn the eye sensor off

Press the  button and select [Off] for [EVF Auto Switch].  “Switching between displays” (P. 22), [EVF Auto Switch] (P. 114)

The monitor or EVF will not turn on

Hold the  button to cycle through the displays.









[EVF Auto Switch] may be off. Hold the  button and select [On] for [EVF Auto Switch].









 “Switching between displays” (P. 22)

The camera is stuck in manual focus (MF) mode

Some lenses are equipped with a manual focus clutch that engages manual focus when the focus ring is slid back. Check the lens. More information can be found in the lens manual.

Error codes

Monitor indication	Possible cause	Corrective action
 No Card	The card is not inserted, or it cannot be recognized.	Insert a card or insert a different card.
 Card Error	There is a problem with the card.	Insert the card again. If the problem persists, format the card. If the card cannot be formatted, it cannot be used.
 Write Protect	Writing to the card is prohibited.	The card write-protect switch is set to the "LOCK" side. Release the switch. (P. 133)
 Card Full	<ul style="list-style-type: none"> The card is full. No more pictures can be taken or no more information such as print reservation can be recorded. There is no space in the card and print reservation or new images cannot be recorded. 	Replace the card or erase unwanted pictures. Before erasing, download important images to a PC.
	Card cannot be read. Card may not have been formatted.	<ul style="list-style-type: none"> Select [Clean Card], press the OK and turn off the camera. Remove the card and wipe the metallic surface with a soft, dry cloth. Select [Format] ▶ [Yes], and then press the OK to format the card. Formatting the card erases all data on the card.
 No Picture	There are no pictures on the card.	The card contains no pictures. Record pictures and play back.
 Picture Error	The selected picture cannot be displayed for playback due to a problem with this picture. Or the picture cannot be used for playback on this camera.	Use image processing software to view the picture on a PC. If that cannot be done, the image file is damaged.
 The Image Cannot Be Edited	Pictures taken with another camera cannot be edited on this camera.	Use image processing software to edit the picture.

Monitor indication	Possible cause	Corrective action
		Turn off the camera and wait for the internal temperature to cool.
 Internal camera temperature is too high. Please wait for cooling before camera use.	The internal temperature of the camera has risen due to sequential shooting.	Wait a moment for the camera to turn off automatically. Allow the internal temperature of the camera to cool before resuming operations.
 Battery Empty	The battery is drained.	Charge the battery.
 No Connection	The camera is not correctly connected to a computer, printer, HDMI display, or other device.	Reconnect the camera.
 No Paper	There is no paper in the printer.	Load some paper in the printer.
 No Ink	The printer has run out of ink.	Replace the ink cartridge in the printer.
 Jammed	The paper is jammed.	Remove the jammed paper.
Settings Changed	The printer's paper cassette has been removed or the printer has been manipulated while making settings on the camera.	Do not manipulate the printer while making settings on the camera.
 Print Error	There is a problem with the printer and/or camera.	Turn off camera and printer. Check the printer and remedy any problems before turning the power on again.
 Cannot Print	Pictures recorded on other cameras may not be printed on this camera.	Use a personal computer to print.

Monitor indication	Possible cause	Corrective action
The lens is locked. Please extend the lens.	The lens of the retractable lens stays retracted.	Extend the lens.
Please check the status of a lens.	An abnormality has occurred between the camera and the lens.	Turn off the camera, check the connection with the lens, and turn the power on again.
This lens is not supported.	The lens does not support the selected shooting mode.	Choose a lens that does or choose a different shooting mode.

Defaults

*1: Default can be restored by selecting [Full] for [Reset].

*2: Default can be restored by selecting [Basic] for [Reset].

Button Functions/Live Control/LV Super Control

Function	Default	*1	*2	
ISO	AUTO	✓	✓	63
Sequential shooting/Self-timer		✓	✓	66
AF target settings		✓	✓	61
Flash photography		✓	✓	64
AF mode	S-AF	✓	✓	72
AF mode	C-AF	✓	✓	72
Aspect ratio	4:3	✓	✓	73
	L N	✓	✓	73
(Standard)	1920×1080 Fine 60p	✓	✓	74
(4K)	3840×2160 30p	—	—	75
(Clips)	1920×1080 Normal 60p 4s	✓	✓	75
(High-speed)	1280×720 HighSpeed 120fps	—	—	75
Movie (exposure) mode	P	✓	—	76

Shooting Menu

Tab	Function	Default	*1	*2	
	Reset	Basic	—	—	98
	Picture Mode	Natural	✓	✓	69, 99
	Digital Tele-converter	Off	✓	✓	99
	Metering		✓	✓	80
	Image Stabilizer	S-IS On	✓	✓	78
	AF Illuminator	On	✓	✓	99
	Elec. Zoom Speed	Normal	✓	—	100
		±0.0	✓	✓	77
	Intrvl. Sh./Time Lapse	Off	✓	✓	100

Video Menu

Tab	Function	Default	*1	*2	
	Movie	On	✓	✓	102
	Recording Volume	±0	✓	—	102
	AF Mode	C-AF	✓	✓	102
	Image Stabilizer	M-IS 1	✓	✓	78
	Elec. Zoom Speed	Normal	✓	—	102
	Video Frame Rate	30p	✓	—	74, 102
	Video Bit Rate	Fine	✓	—	74, 102

▶ Playback Menu

Tab	Function		Default	*1	*2	☞	
▶	📄	Start	—	—	—	92	
		BGM	Happy Days	✓	✓		
		Slide	All	✓	✓		
		Slide Interval	3 sec	✓	—		
		Movie Interval	Short	✓	—		
	📁			On	✓	✓	103
	Edit	Sel. Image	RAW Data Edit	—	—	—	103
			JPEG Edit	—			104
			Movie Edit	—			105, 106
			🎤	—			95, 104
		Image Overlay	—	105			
Print Order		—	—	—	—	130	
Reset Protect		—	—	—	—	106	
Connection to Smartphone		—	—	—	—	121	

⚙ Custom Menu

Tab	Function		Default	*1	*2	☞	
⚙	AF/MF						
	A	AEL/AFL	S-AF	mode1	✓	✓	109, 115
			C-AF	mode2			
			MF	mode1			
	AF Targeting Pad		Off	✓	✓	109	
	☉Face Priority		☉	✓	—	62, 109	
	MF Assist	Magnify	Off	✓	—	109, 115	
		Peaking	Off	✓	—	115	
	Reset Lens		On	✓	✓	109	
	Button/Dial						
	B	Button	Fn1 Function	AEL/AFL	✓	—	85, 109
		Function	Fn2 Function	Digital Tele-converter	✓	—	
	Dial Function		P	Front dial: <input checked="" type="checkbox"/> Rear dial: Ps	✓	—	109
			A	Front dial: <input checked="" type="checkbox"/> Rear dial: FNo.			
			S	Front dial: <input checked="" type="checkbox"/> Rear dial: Shutter			
M			Front dial: FNo. Rear dial: Shutter				

Tab	Function	Default	*1	*2			
	Disp/■)PC						
	C1 Control Settings	Auto	LV-C	✓	—	67, 110	
		P/A/S/M	LV-C	✓	—		
		ART	LV-C	✓	—		
		SCN/ AP	LV-C	✓	—		
	/Info Settings	Info	Image Only, Overall	✓	✓	110, 116	
		LV-Info	Custom1 () , Custom2 (Level Gauge)	✓	—		
		Settings	25, My Clips, Calendar	✓	—		
	Live View Boost		Off	✓	✓	110	
	Flicker reduction		Auto	✓	—	110	
	Displayed Grid		Off	✓	—	110	
	Peaking Color		White	✓	—	110	
	C2 	On		✓	✓	110	
		HDMI	Output Size	1080p	✓	—	110, 118
			HDMI Control	Off	✓	—	
	USB Mode		Auto	✓	✓	110	
	Exp/ISO/BULB						
D1	Exposure Shift		±0	✓	—	111	
	ISO-Auto Set	High Limit	6400	✓	✓		
		Default	200	✓	✓		
Noise Filter		Standard	✓	✓	111		
Noise Reduct.		Auto	✓	✓	111		
D2	Bulb/Time Timer		8min	✓	✓	111	
	Live Bulb		Off	✓	—	111	
	Live Time		0.5 sec	✓	—	111	
	Composite Settings		1 sec	✓	—	50, 111	
Custom							
E	X-Sync.		1/250	✓	✓	112, 119	
	Slow Limit		1/60	✓	✓	112, 119	
	+		Off	✓	✓	112	
	+WB		AUTO	✓	—	112	



Tab	Function	Default	*1	*2			
	◀WB/Color						
		◀ Set	◀-1 F, ◀-2 N, ◀-3 M, ◀-4 S	✓	✓	112, 119	
		WB	Auto	✓	✓	70, 112	
		AUTO Keep Warm Color	On	✓	✓	112	
		Color Space	sRGB	✓	✓	84, 112	
	Record						
		File Name	Reset	✓	—	113	
		Edit Filename	—	✓	—	113	
		Copyright Settings	Copyright Info.	Off	✓	—	113
			Artist Name	—	—	—	
	Copyright Name		—	—	—		
	EVF						
		EVF Auto Switch	On	✓	—	114, 144	
		EVF Adjust	EVF Auto Luminance	On	✓	—	114
			EVF Adjust	±0, ±0			
	Utility						
	Pixel Mapping	—	—	—	114, 141		
	Level Adjust	—	✓	—	114		
	Touchscreen Settings	On	✓	—	114		
	Sleep	1 min	✓	✓	18, 114		
	Eye-Fi	On	✓	—	114		
	Certification	—	—	—	114		

ƒ Setup Menu

Tab	Function	Default	*1	*2		
ƒ	Card Setup	—	—	—	108	
		—	—	—	19	
		—	—	—	107	
		±0, ±0, Natural	✓	—	107	
	Rec View	0.5 sec	✓	—	107	
	Wi-Fi Settings	Wi-Fi Connect Settings	Private	✓	—	123
		Private Password	—	—	—	
		Reset share Order	—	—	—	124
		Reset Wi-Fi Settings	—	—	—	
	Firmware	—	—	—	107	

Specifications

■ Camera

Product type	
Product type	Digital camera with interchangeable Micro Four Thirds Standard lens system
Lens	M.Zuiko Digital, Micro Four Thirds System Lens
Lens mount	Micro Four Thirds mount
Equivalent focal length on a 35 mm film camera	Approx. twice the focal length of the lens
Image pickup device	
Product type	4/3" Live MOS sensor
Total no. of pixels	Approx. 17.20 million pixels
No. of effective pixels	Approx. 16.05 million pixels
Screen size	17.3 mm (H) × 13.0 mm (V)
Aspect ratio	1.33 (4:3)
Viewfinder	
Type	Electronic viewfinder with eye sensor
No. of pixels	Approx. 2.36 million dots
Magnification	100%
Eye point	Approx. 19.2 mm (−1 m ⁻¹)
Live view	
Sensor	Uses Live MOS sensor
Magnification	100%
Monitor	
Product type	3.0" TFT color LCD, Vari-angle, touch screen
Total no. of pixels	Approx. 1.04 million dots (aspect ratio 3:2)
Shutter	
Product type	Computerized focal-plane shutter
Shutter speed	1/4000 - 60 sec., bulb photography, time photography
Auto focus	
Product type	Hi-Speed Imager AF
Focusing points	121 points
Selection of focusing point	Auto, Optional
Exposure control	
Metering system	TTL metering system (imager metering) Digital ESP metering/Center weighted averaging metering/Spot metering
Metered range	EV -2 - 20 (Equivalent to M.ZUIKO DIGITAL 17mm f2.8, ISO100)
Shooting modes	 AUTO/ P : Program AE (Program shift can be performed)/ A : Aperture priority AE/ S : Shutter priority AE/ M : Manual/  Movie/ ART : Art Filter/ SCN : Scene/  Advanced Photo
ISO sensitivity	LOW, 200 - 25600 (1/3 EV step)
Exposure compensation	±5.0EV (1/3 EV step)

White balance	
Product type	Image pickup device
Mode setting	Auto/Preset WB (6 settings)/Customized WB/One-touch WB (camera can store up to 4 settings)
Recording	
Memory	SD, SDHC, SDXC and Eye-Fi UHS-II compatible
Recording system	Digital recording, JPEG (DCF2.0), RAW Data
Applicable standards	Exif 2.3, Digital Print Order Format (DPOF), PictBridge
Sound with still pictures	Wave format
Movie	MPEG-4 AVC/H.264
Audio	Stereo, PCM 48kHz
Playback	
Display format	Single-frame playback/Close-up playback/Index display/Calendar display
Drive	
Drive mode	Single-frame shooting/Sequential shooting/Self-timer
Sequential shooting	Up to approximately 8.6 fps ()
Self-timer	Operation time: 12 sec./2 sec./Customized
Energy saving function	Switch to sleep mode: 1 minute (This function can be customized.) Power OFF: 4 hours
Flash	
Guide number	5.8 (ISO100·m)/8.2 (ISO200·m)
Firing angle	Covers the angle of view of a 14 mm lens (28 mm in 35 mm format)
Flash control mode	TTL-AUTO (TTL pre-flash mode)/MANUAL
Sync speed	1/250 s or slower
Wireless LAN	
Compatible standard	IEEE 802.11b/g/n
External connector	
Micro-USB connector/HDMI micro connector (type D)	
Power supply	
Battery	Lithium-ion Battery ×1
Dimensions/weight	
Dimensions	121.5 mm (W) × 83.6 mm (H) × 49.5 mm (D) (4.8" × 3.3" × 1.9") (excluding protrusions)
Weight	Approx. 410 g (0.9 lb.) (including battery and memory card)
Operating environment	
Temperature	0 °C - 40 °C (32 °F - 104 °F) (operation)/ -20 °C - 60 °C (-4 °F - 140 °F) (storage)
Humidity	30% - 90% (operation)/10% - 90% (storage)

HDMI, the HDMI logo and High-Definition Multimedia Interface are trademarks or registered trademarks of HDMI Licensing LLC.

HDMI™
HIGH-DEFINITION MULTIMEDIA INTERFACE

■ Lithium-ion battery

MODEL NO.	BLS-50
Product type	Rechargeable Lithium ion battery
Nominal voltage	DC 7.2 V
Nominal capacity	1210 mAh
No. of charge and discharge times	Approx. 500 times (varies with usage conditions)
Ambient temperature	0 °C - 40 °C (32 °F - 104 °F) (charging)
Dimensions	Approx. 35.5 mm (W) × 12.8 mm (H) × 55 mm (D) (1.4" × 0.5" × 2.2")
Weight	Approx. 46 g (0.1 lb.)

■ Lithium-ion charger

MODEL NO.	BCS-5
Rated input	AC 100V - 240V (50/60Hz)
Rated output	DC 8.35V, 400 mA
Charging time	Approx. 3 hours 30 minutes (room temperature)
Ambient temperature	0 °C - 40 °C (32 °F - 104 °F) (operation)/ -20 °C - 60 °C (-4 °F - 140 °F) (storage)
Dimensions	Approx. 62 mm (W) × 38 mm (H) × 83 mm (D) (2.4" × 1.5" × 3.3")
Weight (without AC cable)	Approx. 70 g (0.15 lb.)

- The AC cable supplied with this device is for use only with this device and should not be used with other devices. Do not use cables for other devices with this device.

- SPECIFICATIONS ARE SUBJECT TO CHANGE WITHOUT ANY NOTICE OR OBLIGATION ON THE PART OF THE MANUFACTURER.
- Visit our website for the latest specifications.

SAFETY PRECAUTIONS

**CAUTION**RISK OF ELECTRIC SHOCK
DO NOT OPEN

CAUTION: TO REDUCE THE RISK OF ELECTRICAL SHOCK, DO NOT REMOVE COVER (OR BACK). NO USER-SERVICEABLE PARTS INSIDE. REFER SERVICING TO QUALIFIED OLYMPUS SERVICE PERSONNEL.



An exclamation mark enclosed in a triangle alerts you to important operating and maintenance instructions in the documentation provided with the product.

**WARNING**

If the product is used without observing the information given under this symbol, serious injury or death may result.

**CAUTION**

If the product is used without observing the information given under this symbol, injury may result.

**NOTICE**

If the product is used without observing the information given under this symbol, damage to the equipment may result.

WARNING!

TO AVOID THE RISK OF FIRE OR ELECTRICAL SHOCK, NEVER DISASSEMBLE, EXPOSE THIS PRODUCT TO WATER OR OPERATE IN A HIGH HUMIDITY ENVIRONMENT.

General Precautions

Read All Instructions — Before you use the product, read all operating instructions. Save all manuals and documentation for future reference.

Power Source — Connect this product only to the power source described on the product label.

Foreign Objects — To avoid personal injury, never insert a metal object into the product.

Cleaning — Always unplug this product from the wall outlet before cleaning. Use only a damp cloth for cleaning. Never use any type of liquid or aerosol cleaner, or any type of organic solvent to clean this product.

Heat — Never use or store this product near any heat source such as a radiator, heat register, stove, or any type of equipment or appliance that generates heat, including stereo amplifiers.

Attachments — For your safety, and to avoid damaging the product, use only accessories recommended by Olympus.

Location — To avoid damage to the product, mount the product securely on a stable tripod, stand, or bracket.

WARNING

- Do not use the camera near flammable or explosive gases.
- Rest your eyes periodically when using the viewfinder.

Failure to observe this precaution could result in eyestrain, nausea, or sensations similar to motion sickness. The length and frequency of the required rest varies with the individual; use your own judgement. If you feel tired or unwell, avoid using the viewfinder and if necessary consult a physician.

- Do not use the flash and LED (including AF illuminator) on people (infants, small children, etc.) at close range.
 - You must be at least 1 m (3 ft.) away from the faces of your subjects. Firing the flash too close to the subject's eyes could cause a momentary loss of vision.
- Do not look at the sun or strong lights with the camera.

- **Keep young children, infants away from the camera.**
 - Always use and store the camera out of the reach of young children and infants to prevent the following dangerous situations which could cause serious injury:
 - Becoming entangled in the camera strap, causing strangulation.
 - Accidentally swallowing the battery, cards or other small parts.
 - Accidentally firing the flash into their own eyes or those of another child.
 - Accidentally being injured by the moving parts of the camera.
- **Should you notice that the charger is emitting smoke, heat, or an unusual noise or smell, immediately cease use and unplug the charger from the power outlet, and then contact an authorized distributor or service center.**
- **Stop using the camera immediately if you notice any unusual odors, noise, or smoke around it.**
 - Never remove the batteries with bare hands, which may cause a fire or burn your hands.
- Never hold or operate the camera with wet hands.
This may cause overheating, exploding, burning, electrical shocks, or malfunctions.
- **Do not leave the camera in places where it may be subject to extremely high temperatures.**
 - Doing so may cause parts to deteriorate and, in some circumstances, cause the camera to catch fire. Do not use the charger if it is covered (such as a blanket). This could cause overheating, resulting in fire.
- **Handle the camera with care to avoid getting a low temperature burn.**
 - When the camera contains metal parts, overheating can result in a low-temperature burn. Pay attention to the following:
 - When used for a long period, the camera will get hot. If you hold on to the camera in this state, a low-temperature burn may be caused.
 - In places subject to extremely cold temperatures, the temperature of the camera's body may be lower than the environmental temperature. If possible, wear gloves when handling the camera in cold temperatures.
- To protect the high-precision technology contained in this product, never leave the camera in the places listed below, no matter if in use or storage:
 - Places where temperatures and/or humidity are high or go through extreme changes. Direct sunlight, beaches, locked cars, or near other heat sources (stove, radiator, etc.) or humidifiers.
 - In sandy or dusty environments.
 - Near flammable items or explosives.
 - In wet places, such as bathrooms or in the rain.
 - In places prone to strong vibrations.
- The camera uses a lithium-ion battery specified by Olympus. Charge the battery with the specified charger. Do not use any other chargers.
- Never incinerate or heat batteries in microwaves, on hot plates, or in pressure vessels, etc.
- Never leave the camera on or near electromagnetic devices.
This may cause overheating, burning, or exploding.
- Do not connect terminals with any metallic objects.
- Take precautions when carrying or storing batteries to prevent them from coming into contact with any metal objects such as jewelry, pins, fasteners, keys, etc.
The short circuit may cause overheating, exploding, or burning, which burn or damage you.
- To prevent causing battery leaks or damaging their terminals, carefully follow all instructions regarding the use of batteries. Never attempt to disassemble a battery or modify it in any way, solder, etc.
- If battery fluid gets into your eyes, flush your eyes immediately with clear, cold running water and seek medical attention immediately.
- If you cannot remove the battery from the camera, contact an authorized distributor or service center. Do not try to remove the battery by force.
Damage to the battery exterior (scratches, etc.) may produce heat or an explosion.
- Always store batteries out of the reach of small children and pets. If they accidentally swallow a battery, seek medical attention immediately.
- To prevent batteries from leaking, overheating, or causing a fire or explosion, use only batteries recommended for use with this product.
- If rechargeable batteries have not been recharged within the specified time, stop charging them and do not use them.
- Do not use batteries with scratches or damage to the casing, and do not scratch the battery.

- Never subject batteries to strong shocks or continuous vibration by dropping or hitting. This may cause exploding, overheating, or burning.
- If a battery leaks, has unusual odor, becomes discolored or deformed, or becomes abnormal in any other way during operation, stop using the camera, and keep away from fire immediately.
- If a battery leaks fluid onto your clothing or skin, remove the clothing and flush the affected area with clean, running cold water immediately. If the fluid burns your skin, seek medical attention immediately.
- The Olympus lithium-ion battery is designed to be used only for the Olympus digital camera. Do not use the battery to other devices.
- **Do not allow children or animals/pets to handle or transport batteries (prevent dangerous behaviour such as licking, putting in mouth or chewing).**

Use Only Dedicated Rechargeable Battery and Battery Charger

We strongly recommend that you use only the genuine Olympus dedicated rechargeable battery and battery charger with this camera.

Using a non-genuine rechargeable battery and/or battery charger may result in fire or personal injury due to leakage, heating, ignition or damage to the battery. Olympus does not assume any liability for accidents or damage that may result from the use of a battery and/or battery charger that are not genuine Olympus accessories.

CAUTION

- **Do not cover the flash with a hand while firing.**
- Never store batteries where they will be exposed to direct sunlight, or subjected to high temperatures in a hot vehicle, near a heat source, etc.
- Keep batteries dry at all times.
- The battery may become hot during prolonged use. To avoid minor burns, do not remove it immediately after using the camera.
- This camera uses one Olympus lithium-ion battery. Use the specified genuine battery. There is a risk of explosion if the battery is replaced with the incorrect battery type.
- Please recycle batteries to help save our planet's resources. When you throw away dead batteries, be sure to cover their terminals and always observe local laws and regulations.

NOTICE

- **Do not use or store the camera in dusty or humid places.**
- **Use SD/SDHC/SDXC memory cards or Eye-Fi cards only. Never use other types of cards.**
If you accidentally insert another type of card into the camera, contact an authorized distributor or service center. Do not try to remove the card by force.
- Regularly back up important data to a computer or other storage device to prevent accidental loss.
- OLYMPUS accepts no liability for any loss of data associated with this device.
- Be careful with the strap when you carry the camera. It could easily catch on stray objects and cause serious damage.
- Before transporting the camera, remove a tripod and all other non-OLYMPUS accessories.
- Never drop the camera or subject it to severe shocks or vibrations.
- When attaching the camera to or removing it from a tripod, rotate the tripod screw, not the camera.
- Do not touch electric contacts on cameras.
- Do not leave the camera pointed directly at the sun. This may cause lens or shutter curtain damage, color failure, ghosting on the image pickup device, or may possibly cause fires.
- Do not leave the viewfinder exposed to a strong light source or direct sunlight. The heat may damage the viewfinder.
- Do not push or pull severely on the lens.
- Be sure to remove any water droplets or other moisture from the product before replacing the battery or opening or closing covers.
- Before storing the camera for a long period, remove the batteries. Select a cool, dry location for storage to prevent condensation or mold from forming inside the camera. After storage, test the camera by turning it on and pressing the shutter button to make sure that it is operating normally.
- The camera may malfunction if it is used in a location where it is subject to a magnetic/ electromagnetic field, radio waves, or high voltage, such as near a TV set, microwave, video game, loud speakers, large monitor unit, TV/radio tower, or transmission towers. In such cases, turn the camera off and on again before further operation.
- Always observe the operating environment restrictions described in the camera's manual.

- Insert the battery carefully as described in the operating instructions.
- Before loading, always inspect the battery carefully for leaks, discoloration, warping, or any other abnormality.
- Always unload the battery from the camera before storing the camera for a long period.
- When storing the battery for a long period, select a cool location for storage.
- Power consumption by the camera varies depending on which functions are used.
- During the conditions described below, power is consumed continuously and the battery becomes exhausted quickly.
 - The zoom is used repeatedly.
 - The shutter button is pressed halfway repeatedly in shooting mode, activating the auto focus.
 - A picture is displayed on the monitor for an extended period of time.
 - The camera is connected to a printer.
- Using an exhausted battery may cause the camera to turn off without displaying the battery level warning.
- If the battery's terminals get wet or greasy, camera contact failure may result. Wipe the battery well with a dry cloth before use.
- Always charge a battery when using it for the first time, or if it has not been used for a long period.
- When operating the camera with battery power at low temperatures, try to keep the camera and spare battery as warm as possible. A battery that has run down at low temperatures may be restored after it is warmed at room temperature.
- Before going on a long trip, and especially before traveling abroad, purchase extra batteries. A recommended battery may be difficult to obtain while traveling.
- A strip of light may appear on the top/bottom of the monitor, but this is not a malfunction.
- When a subject is viewed diagonally in the camera, the edges may appear zigzagged on the monitor. This is not a malfunction; it will be less noticeable in playback mode.
- In places subject to low temperatures, the monitor may take a long time to turn on or its color may change temporarily. When using the camera in extremely cold places, it is a good idea to occasionally place it in a warm place. The monitor exhibiting poor performance due to low temperatures will recover in normal temperatures.
- The monitor of this product is manufactured with high-quality accuracy, however, there may be a stuck or dead pixel on the monitor. These pixels do not have any influence on the image to be saved. Because of the characteristics, the unevenness of the color or brightness may also be found depending on the angle, but this is due to the structure of the monitor. This is not a malfunction.

Legal and Other Notices

- Olympus makes no representations or warranties regarding any damages, or benefit expected by using this unit lawfully, or any request from a third person, which are caused by the inappropriate use of this product.
- Olympus makes no representations or warranties regarding any damages or any benefit expected by using this unit lawfully which are caused by erasing picture data.

Disclaimer of Warranty

- Olympus makes no representations or warranties, either expressed or implied, by or concerning any content of these written materials or software, and in no event shall be liable for any implied warranty of merchantability or fitness for any particular purpose or for any consequential, incidental or indirect damages (including but not limited to damages for loss of business profits, business interruption and loss of business information) arising from the use or inability to use these written materials or software or equipment. Some countries do not allow the exclusion or limitation of liability for consequential or incidental damages or of the implied warranty, so the above limitations may not apply to you.
- Olympus reserves all rights to this manual.

Using the wireless LAN function

- **Turn off the camera in hospitals and other locations where medical equipment is present.**

The radio waves from the camera may adversely affect medical equipment, causing a malfunction that results in an accident.

- **Turn off the camera when onboard aircraft.**

Using wireless devices onboard may hinder safe operation of the aircraft.

Monitor

- Do not push the monitor forcibly; otherwise the image may become vague, resulting in a playback mode failure or damage to the monitor.

Warning

Unauthorized photographing or use of copyrighted material may violate applicable copyright laws. Olympus assumes no responsibility for unauthorized photographing, use or other acts that infringe upon the rights of copyright owners.

Copyright Notice

All rights reserved. No part of these written materials or this software may be reproduced or used in any form or by any means, electronic or mechanical, including photocopying and recording or the use of any type of information storage and retrieval system, without the prior written permission of Olympus. No liability is assumed with respect to the use of the information contained in these written materials or software, or for damages resulting from the use of the information contained therein. Olympus reserves the right to alter the features and contents of this publication or software without obligation or advance notice.

FCC Notice

This equipment has been tested and found to comply with the limits for a Class B digital device, pursuant to part 15 of the FCC Rules. These limits are designed to provide reasonable protection against harmful interference in a residential installation. This equipment generates, uses and can radiate radio frequency energy and, if not installed and used in accordance with the instructions, may cause harmful interference to radio communications. However, there is no guarantee that interference will not occur in a particular installation. If this equipment does cause harmful interference to radio or television reception, which can be determined by turning the equipment off and on, the user is encouraged to try to correct the interference by one or more of the following measures:

- Reorient or relocate the receiving antenna.
- Increase the separation between the equipment and receiver.
- Connect the equipment into an outlet on a circuit different from that to which the receiver is connected.
- Consult the dealer or an experienced radio/TV technician for help.
- Only the OLYMPUS-supplied USB cable should be used to connect the camera to USB enabled personal computers.

FCC/IC Caution

Changes or modifications not expressly approved by the party responsible for compliance could void the user's authority to operate the equipment.

This transmitter must not be co-located or operated in conjunction with any other antenna or transmitter.

This equipment complies with FCC radiation exposure limits set forth for an uncontrolled environment and meets the FCC radio frequency (RF) Exposure Guidelines. This equipment has very low levels of RF energy that are deemed to comply without testing of specific absorption rate (SAR).

The available scientific evidence does not show that any health problems are associated with using low power wireless devices. There is no proof, however, that these low power wireless devices are absolutely safe. Low power Wireless devices emit low levels of radio frequency energy (RF) in the microwave range while being used. Whereas high levels of RF can produce health effects (by heating tissue), exposure of low-level RF that does not produce heating effects causes no known adverse health effects. Many studies of low-level RF exposures have not found any biological effects. Some studies have suggested that some biological effects might occur, but such findings have not been confirmed by additional research. IM006 has been tested and found to comply with IC radiation exposure limits set forth for an uncontrolled environment and meets RSS-102 of the IC radio frequency (RF) Exposure rules.

For customers in North America, Central America, South America and the Caribbean

Declaration of Conformity

Model Number : IM006
Trade Name : OLYMPUS
Responsible Party : **OLYMPUS AMERICA INC.**
Address : 3500 Corporate Parkway, P. O. Box 610, Center Valley, PA 18034-0610, USA
Telephone Number : 484-896-5000

Tested To Comply With FCC Standards

FOR HOME OR OFFICE USE

This device complies with Part 15 of FCC Rules and Industry Canada licence-exempt RSS standard(s).

Operation is subject to the following two conditions:

- (1) This device may not cause harmful interference.
- (2) This device must not accept any interference received, including interference that may cause undesired operation.

CAN ICES-3(B)/NMB-3(B)

OLYMPUS AMERICAS LIMITED WARRANTY - OLYMPUS AMERICA INC. PRODUCTS

Olympus warrants that the enclosed Olympus® imaging product(s) and related Olympus® accessories (individually a "Product" and collectively the "Products") will be free from defects in materials and workmanship under normal use and service for a period of one (1) year from the date of purchase.

If any Product proves to be defective within the one-year warranty period, the customer must return the defective Product to the authorized Olympus Repair Service Center designated by Olympus, following the procedure set forth below (See "WHAT TO DO WHEN SERVICE IS NEEDED").

Olympus, at its sole discretion, will repair, replace, or adjust the defective Product at Olympus's cost, provided that an Olympus investigation and factory inspection disclose that (a) such defect developed under normal and proper use and (b) the Product is covered under this limited warranty.

Repair, replacement, or adjustment of defective Products shall be Olympus's sole obligation and the customer's sole remedy hereunder. Repair or replacement of a Product shall not extend the warranty period provided herein, unless required by law.

Except where prohibited by law, the customer is liable and shall pay for shipment of the Products to the designated Olympus Repair Service Center. Olympus shall not be obligated to perform preventive maintenance, installation, deinstallation, or maintenance.

Olympus reserves the right to (i) use reconditioned, refurbished, and/or serviceable used parts (that meet Olympus's quality assurance standards) for warranty or any other

repairs and (ii) make any internal or external design and/or feature changes on or to its products without any liability to incorporate such changes on or to the Products.

WHAT IS NOT COVERED BY THIS LIMITED WARRANTY

Excluded from this limited warranty and not warranted by Olympus in any fashion, either express, implied, or by statute, are:

- (a) products and accessories not manufactured by Olympus and/or not bearing the "OLYMPUS" brand label (the warranty coverage for products and accessories of other manufacturers, which may be distributed by Olympus, is the responsibility of the respective manufacturer of such products and accessories in accordance with the terms and duration of such manufacturers' warranties);
- (b) any Product which has been disassembled, repaired, tampered with, altered, changed, or modified by persons other than Olympus's own authorized service personnel unless repair by others is made with the written consent of Olympus;
- (c) defects or damage to the Products resulting from wear, tear, misuse, abuse, negligence, sand, liquids, impact, improper storage, nonperformance of scheduled operator and maintenance items, battery leakage, use of non-"OLYMPUS" brand accessories, consumables, or supplies, or use of the Products in combination with non-compatible devices;
- (d) software programs;
- (e) supplies and consumables (including but not limited to lamps, ink, paper, film, prints, negatives, cables and batteries); and/or

- (f) Products which do not contain a validly placed and recorded Olympus serial number, unless they are a model on which Olympus does not place and record serial numbers.
- (g) Products shipped, delivered, purchased, or sold from dealers located outside of North America, Central America, South America and the Caribbean; and/or
- (h) Products that are not intended or authorized to be sold in North America, South America, Central America, or the Caribbean (ie. Gray Market Goods).

WARRANTY DISCLAIMER; LIMITATION OF DAMAGES; AFFIRMATION OF ENTIRE WARRANTY AGREEMENT; INTENDED BENEFICIALLY

EXCEPT FOR THE LIMITED WARRANTY SET FORTH ABOVE, OLYMPUS MAKES NO AND DISCLAIMS ALL OTHER REPRESENTATIONS, GUARANTIES, CONDITIONS, AND WARRANTIES CONCERNING THE PRODUCTS, WHETHER DIRECT OR INDIRECT, EXPRESS OR IMPLIED, OR ARISING UNDER ANY STATUTE, ORDINANCE, COMMERCIAL USAGE OR OTHERWISE, INCLUDING BUT NOT LIMITED TO ANY WARRANTY OR REPRESENTATION AS TO THE SUITABILITY, DURABILITY, DESIGN, OPERATION, OR CONDITION OF THE PRODUCTS (OR ANY PART THEREOF) OR THE MERCHANTABILITY OF THE PRODUCTS OR THEIR FITNESS FOR A PARTICULAR PURPOSE, OR RELATING TO THE INFRINGEMENT OF ANY PATENT, COPYRIGHT, OR OTHER PROPRIETARY RIGHT USED OR INCLUDED THEREIN.

IF ANY IMPLIED WARRANTIES APPLY AS A MATTER OF LAW, THEY ARE LIMITED IN DURATION TO THE LENGTH OF THIS LIMITED WARRANTY.

SOME STATES MAY NOT RECOGNIZE A DISCLAIMER OR LIMITATION OF WARRANTIES AND/OR LIMITATION OF LIABILITY SO THE ABOVE DISCLAIMERS AND EXCLUSIONS MAY NOT APPLY.

THE CUSTOMER MAY ALSO HAVE DIFFERENT AND/OR ADDITIONAL RIGHTS AND REMEDIES THAT VARY FROM STATE TO STATE.

THE CUSTOMER ACKNOWLEDGES AND AGREES THAT OLYMPUS SHALL NOT BE RESPONSIBLE FOR ANY DAMAGES THAT THE CUSTOMER MAY INCUR FROM DELAYED SHIPMENT, PRODUCT FAILURE, PRODUCT DESIGN, SELECTION, OR PRODUCTION, IMAGE OR DATA LOSS OR IMPAIRMENT OR FROM ANY OTHER CAUSE, WHETHER LIABILITY IS ASSERED IN CONTRACT, TORT (INCLUDING NEGLIGENCE AND STRICT

PRODUCT LIABILITY) OR OTHERWISE. IN NO EVENT SHALL OLYMPUS BE LIABLE FOR ANY INDIRECT, INCIDENTAL, CONSEQUENTIAL OR SPECIAL DAMAGES OF ANY KIND (INCLUDING WITHOUT LIMITATION LOSS OF PROFITS OR LOSS OF USE), WHETHER OR NOT OLYMPUS SHALL BE OR SHOULD BE AWARE OF THE POSSIBILITY OF SUCH POTENTIAL LOSS OR DAMAGE.

Representations and warranties made by any person, including but not limited to dealers, representatives, salespersons, or agents of Olympus, which are inconsistent or in conflict with or in addition to the terms of this limited warranty, shall not be binding upon Olympus unless reduced to writing and approved by an expressly authorized officer of Olympus.

This limited warranty is the complete and exclusive statement of warranty which Olympus agrees to provide with respect to the Products and it shall supersede all prior and contemporaneous oral or written agreements, understandings, proposals, and communications pertaining to the subject matter hereof.

This limited warranty is exclusively for the benefit of the original customer and cannot be transferred or assigned.

WHAT TO DO WHEN SERVICE IS NEEDED

The customer must contact the designated Olympus Consumer Support Team for your region to coordinate the submission of your Product for repair service. To contact your Olympus Consumer Support Team in your region please visit or call the following:

Canada:

www.olympuscanada.com/repair/
1-800-622-6372

United States:

www.olympusamerica.com/repair/
1-800-622-6372

Latin America:

www.olympusamericalatina.com

The customer must copy or transfer any image or other data saved on a Product to another image or data storage medium prior to sending the Product to Olympus for repair service.

IN NO EVENT SHALL OLYMPUS BE RESPONSIBLE FOR SAVING, KEEPING OR MAINTAINING ANY IMAGE OR DATA SAVED ON A PRODUCT RECEIVED BY IT FOR SERVICE, OR ON ANY FILM CONTAINED WITHIN A PRODUCT RECEIVED BY IT FOR SERVICE, NOR SHALL OLYMPUS BE RESPONSIBLE FOR ANY DAMAGES IN THE EVENT ANY IMAGE OR DATA IS LOST OR IMPAIRED WHILE SERVICE IS BEING PERFORMED (INCLUDING, WITHOUT

LIMITATION, DIRECT, INDIRECT, INCIDENTAL, CONSEQUENTIAL OR SPECIAL DAMAGES, LOSS OF PROFITS OR LOSS OF USE), WHETHER OR NOT OLYMPUS SHALL BE OR SHOULD BE AWARE OF THE POSSIBILITY OF SUCH POTENTIAL LOSS OR IMPAIRMENT.

The customer should package the Product carefully using ample padding material to prevent damage in transit. Once the Product is properly packaged, ship the package to Olympus or the Olympus Authorized Repair Service Center location as instructed by the respective Olympus Consumer Support Team.

When sending Products for repair service, your package should include the following:

- 1) Sales receipt showing date and place of purchase. Handwritten receipts will not be accepted;
- 2) Copy of this limited warranty **bearing the Product serial number corresponding to the serial number on the Product** (unless it is a model on which Olympus does not place and record serial numbers);
- 3) A detailed description of the problem; and
- 4) Sample prints, negatives, digital prints (or files on disk) if available and related to the problem.

KEEP COPIES OF ALL DOCUMENTS. Neither Olympus nor an Olympus Authorized Repair Service Center will be responsible for documents that are lost or destroyed in transit.

When service is completed, the Product will be returned to you postage prepaid.

PRIVACY

Any information provided by you to process your warranty claim shall be kept confidential and will only be used and disclosed for the purposes of processing and performing warranty repair services.

For customers in Europe

Simple Declaration of Conformity

Hereby, OLYMPUS CORPORATION declares that the radio equipment type IM006 is in compliance with Directive 2014/53/EU.

The full text of the EU declaration of conformity is available at the following internet address:
<http://www.olympus-europa.com/>



This symbol [crossed-out wheeled bin WEEE Annex IV] indicates separate collection of waste electrical and electronic equipment in the EU countries.

Please do not throw the equipment into the domestic refuse.

Please use the return and collection systems available in your country for the disposal of this product.



This symbol [crossed-out wheeled bin Directive 2006/66/EC Annex II] indicates separate collection of waste batteries in the EU countries.

Please do not throw the batteries into the domestic refuse.

Please use the return and collection systems available in your country for the disposal of the waste batteries.

Provisions of warranty

In the unlikely event that your product proves to be defective, although it has been used properly (in accordance with the written Instruction Manual supplied with it), during the applicable national warranty period and has been purchased from an authorized Olympus distributor within the business area of OLYMPUS EUROPA SE & Co. KG as stipulated on the website: <http://www.olympus-europa.com>, it will be repaired, or at Olympus's option replaced, free of charge. In order to enable Olympus to provide you with the requested warranty services to your full satisfaction and as fast as possible, please note the information and instructions listed below:

1. To claim under this warranty please follow the instructions on <http://consumer-service.olympus-europa.com> for registration and tracking (this service is not available in all countries) or take the product, the corresponding original invoice or purchase receipt and the completed Warranty Certificate to the dealer where it was purchased or any other Olympus service station within the business area of OLYMPUS EUROPA SE & Co. KG as stipulated on the website: <http://www.olympus-europa.com>, before the end of the applicable national warranty period.
2. Please make sure your Warranty Certificate is duly completed by Olympus or an authorized dealer or Service center. Therefore, please make sure that your name, the name of the dealer, the serial number and the year, month and date of purchase are all completed or the original invoice or the sales receipt (indicating the dealer's name, the date of purchase and product type) is attached to your Warranty Certificate.
3. Since this Warranty Certificate will not be re-issued, keep it in a safe place.
4. Please note that Olympus will not assume any risks or bear any costs incurred in transporting the product to the dealer or Olympus authorized service station.
5. This Warranty does not cover the following and you will be required to pay a repair charge, even for defects occurring within the warranty period referred to above.
 - a. Any defect that occurs due to mishandling (such as an operation performed that is not mentioned in the Instruction Manual, etc.)
 - b. Any defect that occurs due to repair, modification, cleaning, etc. performed by anyone other than Olympus or an Olympus authorized service station.

- c. Any defect or damage that occurs due to transport, a fall, shock, etc. after purchase of the product.
 - d. Any defect or damage that occurs due to fire, earthquake, flood damage, thunderbolt, other natural disasters, environmental pollution and irregular voltage sources.
 - e. Any defect that occurs due to careless or improper storage (such as keeping the product under conditions of high temperature and humidity, near insect repellents such as naphthalene or harmful drugs, etc.), improper maintenance, etc.
 - f. Any defect that occurs due to exhausted batteries, etc.
 - g. Any defect that occurs due to sand, mud, water etc. entering the inside of the product casing.
6. Olympus's sole liability under this Warranty shall be limited to repairing or replacing the product. Any liability under the Warranty for indirect or consequential loss or damage of any kind incurred or suffered by the customer due to a defect of the product, and in particular any loss or damage caused to any lenses, films, other equipment or accessories used with the product or for any loss resulting from a delay in repair or loss of data, is excluded. Compelling regulations by law remain unaffected by this.

For customers in Thailand

This telecommunication equipment is in compliance with NTC requirements.

For customers in Mexico

The operation of this equipment is subject to the following two conditions:

- (1) it is possible that this equipment or device may not cause harmful interference, and (2) this equipment or device must accept any interference, including interference that may cause undesired operation.

For customer in Singapore

Complies with IMDA Standards DB104634

Trademarks

- Microsoft and Windows are registered trademarks of Microsoft Corporation.
- Mac is a trademark of Apple Inc.
- SDXC Logo is a trademark of SD-3C, LLC.
- Eye-Fi is a trademark of Eye-Fi, Inc.
- "Shadow Adjustment Technology" function contains patented technologies from Apical Limited.
- Micro Four Thirds, Four Thirds, and the Micro Four Thirds and Four Thirds logos are trademarks or registered trademarks of the OLYMPUS CORPORATION in Japan, the United States, the countries of the European Union, and other countries.
- Wi-Fi is a registered trademark of the Wi-Fi Alliance.
- The Wi-Fi CERTIFIED logo is a certification mark of the Wi-Fi Alliance.
- The standards for camera file systems referred to in this manual are the "Design Rule for Camera File System/DCF" standards stipulated by the Japan Electronics and Information Technology Industries Association (JEITA).
- All other company and product names are registered trademarks and/or trademarks of their respective owners.



THIS PRODUCT IS LICENSED UNDER THE AVC PATENT PORTFOLIO LICENSE FOR THE PERSONAL AND NONCOMMERCIAL USE OF A CONSUMER TO (i) ENCODE VIDEO IN COMPLIANCE WITH THE AVC STANDARD ("AVC VIDEO") AND/OR (ii) DECODE AVC VIDEO THAT WAS ENCODED BY A CONSUMER ENGAGED IN A PERSONAL AND NON-COMMERCIAL ACTIVITY AND/OR WAS OBTAINED FROM A VIDEO PROVIDER LICENSED TO PROVIDE AVC VIDEO. NO LICENSE IS GRANTED OR SHALL BE IMPLIED FOR ANY OTHER USE. ADDITIONAL INFORMATION MAY BE OBTAINED FROM MPEG LA, L.L.C. SEE [HTTP://WWW.MPEGLA.COM](http://www.mpegla.com)

The software in this camera may include third party software. Any third party software is subject to the terms and conditions, imposed by the owners or licensors of that software, under which software is provided to you.

Those terms and other third party software notices, if any, may be found in the software notice PDF file stored at

<http://www.olympus.co.jp/en/support/imgs/digicamera/download/notice/notice.cfm>

The following functions are added/modified by firmware update.

Additions/modifications by the firmware version 1.1 

Information displays while shooting	166
Wireless remote control flash photography	166
Default settings	167

Additions/modifications by the firmware version 1.1

Information displays while shooting

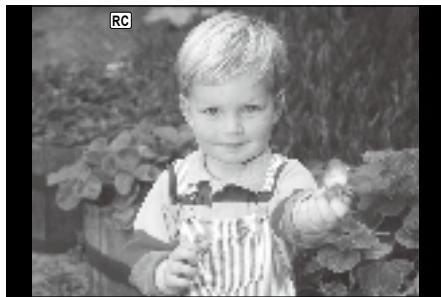

Monitor display during still photography

The icon display for RC Mode has been added.



Wireless remote control flash photography (⚡ RC Mode)

You can take wireless flash photographs using the built-in flash and a special flash with a remote control function. The camera can separately control each of three groups of remote flash units, and the internal flash. See the instruction manuals provided with the external flash units for details.

- 1 Set the remote flash units to RC mode and place them as desired.
 - Turn the external flash units on, press the MODE button, and select RC mode.
 - Select a channel and group for each external flash unit.
- 2 Select [On] for [⚡ RC Mode] in  Shooting Menu 2.
 - Press the  button to exit to the RC mode display. Press the **INFO** button to cycle between LV super controls or live controls and the RC mode display.
 - Select a flash mode (note that red-eye reduction is not available in RC mode).
 -  is displayed on the monitor.



3 Adjust the settings for each group in the RC mode display.

Group

- Select the flash control mode and adjust the flash intensity separately for each group. For MANUAL, select the flash intensity.

Adjust settings for the camera flash unit.

Flash intensity value

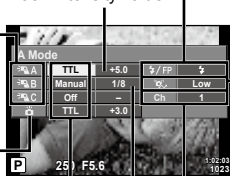

Flash control mode

Normal flash/Super FP flash

- Switch between normal flash and Super FP flash.

Communication light level

- Set the communication light level to [HI], [MID], or [LO].

Channel

- Set the communication channel to the same channel used on the flash.

4 Rotate the **ON/OFF** lever to **UP** to raise the flash.

- After confirming that the flash has charged, take a test shot.

■ Wireless flash control range

Position the wireless flash units with their remote sensors facing the camera. The following illustration shows the approximate ranges at which the flash units can be positioned. The actual control range varies with local conditions.

- We recommend using a single group of up to three remote flash units.
- Remote flash units cannot be used for second curtain slow synchronization exposures longer than 4 seconds.
- If the subject is too close to the camera, the control flashes emitted by the camera flash may affect exposure (this effect can be reduced by reducing the output of the camera flash by, for example, using a diffuser).
- The upper limit of flash synchronization timing is 1/160 sec. when using the flash in RC mode.

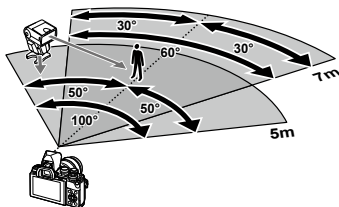

Default settings

The default settings for new functions and the modified default settings are as follows.

*1: Default can be restored by selecting [Full] for [Reset].

*2: Default can be restored by selecting [Basic] for [Reset].

📷 Shooting Menu

Tab	Function	Default	*1	*2	👉
2	⚡ RC Mode	Off	✓	✓	166

Symbols

(Beep sound)	110
(Protect)	93
Slow Limit.....	112, 119
+WB	112
X-Sync	112, 119
(Close-up playback)	91
(Monitor brightness adjustment).....	107
(Index display).....	91, 96, 117
/Info Settings	110, 116
.....	112
.....	66
(Single-frame erase).....	94
(language).....	107
(One-touch white balance).....	86
(Image selection).....	94
(Face priority AF).....	62
(Image rotation).....	103
Keep Warm Color	112
(Preview).....	86
(Sequential Low)	66
(Sequential High)	66
Info	110
Settings	110
Control Settings.....	110
UP.....	64
(Shortcut) Button.....	26

A

A (Aperture priority mode).....	46
Accessories	137
AdobeRGB	84
Advanced photo mode.....	32
AE Bracketing.....	40
AEL/AFL	115
AE lock	60, 86, 115
AF Area.....	61
AF illuminator.....	25, 99
AF Mode.....	72
Movie	102

AF Targeting Pad.....	109
AF target settings	61
AF tracking	72
ART (Art filter).....	42
Art fade.....	54
Aspect ratio.....	73
Audio recording	
Still image	95
AUTO mode ()	27

B

Backlight HDR	29, 30, 31
Battery charge	13
Battery level.....	18
Beep sound	110
BGM	58, 92
Bleach Bypass.....	43
BULB	49
Bulb photography	49
Bulb/Time Timer	111
Button Function	85

C

C-AF (Continuous AF)	72
C-AF+TR (AF tracking).....	72
Calendar display.....	91, 117
Card.....	15, 133
Card Setup	108
Certification.....	114
Clips.....	56
Close-up playback.....	91
Color Filter	82
Color Space.....	84, 112
Composite Settings	111
Compression rate	73, 119, 134
Connection	
Computer.....	125
Printer	127
Smartphone	120
Continuous AF.....	72
Contrast.....	81

Control Settings.....	110
Copyright Settings.....	113
Custom Menu	109, 149

D

Date/time setting (🕒).....	19
Dial Function.....	109
Digital Tele-converter.....	60, 99
Diopter adjustment dial.....	22
Displayed Grid.....	110
DPOF.....	130

E

Edit Filename.....	113
Effect (i-Enhance).....	83
Elec. Zoom Speed	
Movie	102
Still image	100
Erase	
All images	108
Selected images	94
Single-frame	94
EVF Adjust.....	114
EVF Auto Switch.....	114
Exif data.....	113
Exposure compensation.....	60
Exposure Shift	111
External flash units	136
Eye-Fi.....	114
Eye priority AF	62

F

Face priority AF	62
File format.....	134
File Name	113
File size	134
Firmware.....	107
Flash.....	64
Flash intensity control.....	77
Flicker reduction	110
Fn1 button	60, 87
Fn2 button	60, 87
Focus Bracketing.....	41
Focus mode.....	72

Focus ring.....	72
Format	108

G

GPS log.....	123
Gradation.....	82

H

HDMI	110, 118
HDR.....	36
Highlight&Shadow Control.....	84
High-speed movie.....	59
Histogram display	23

I

Image aspect.....	73
Image Overlay	105
Image quality	
Movie (📹⏪⏩).....	74
Still image (📷⏪⏩).....	73
Image quality settings	
Movie	74
Still image	73, 112, 119, 134
Image selection	94
Image size	
Movie	74
Still image	112, 119, 134
Image Stabilizer.....	78
Movie	102
Image transfer to smartphone	122
Index display.....	91, 117
INFO button.....	23, 89
Information display	20
Playback	88
In-movie image capture	105
Installation	126
Interchangeable lenses	135
ISO-Auto Set	111
ISO sensitivity.....	63

J

JPEG Edit.....	104
----------------	-----

K

Keystone Compensation	39
-----------------------------	----

L	
Language setting ()	107
Level Adjust	114
Level gauge	23
Light box display	116
Light Trails	29, 30
Live Bulb	111
Live composite photography	50
Live control	67
Live guide	27
LIVE TIME	34, 49
Live View Boost	110
Long time exposure (BULB/LIVE TIME)	49
LV-Info	110, 116
LV super control panel	68

M

M (Manual mode)	48
Manual focus	72
Menu	97, 148
Metering	80
MF	86
MF Assist	109, 115
MF (Manual focus)	72
Mode dial	24
Monitor brightness adjustment	107
Monochrome Color	83
Movie 	102
Movie Effects	54
Movie mode	53, 76
Movie shooting	52
Movie Tele-converter	54
Multi echo	54
Multiple Exposure	35
My Clips	56, 95

N

Noise Filter	111
Noise Reduct	111
Number of storable still pictures	134

O

Ol.Share	120
----------	-----

Old film	54
OLYMPUS Viewer 3	126
One shot echo	54
One-touch white balance ()	71, 86

P

P (Program mode)	45
Panorama	38
Partial Color	44
PC software	126
Peaking	86, 115
Peaking Color	110
PictBridge	127
Picture Mode	69, 99
Pixel Count	119, 134
Pixel mapping	114, 141
Playback	
Movie	93
Playback Menu	103, 149
Position information	123
Preview ()	86
Printing	127
Program shift (Ps)	45
Protect	93
Protect reset	106

R

RAW Data Edit	103
RAW image	73
Recording Volume	102
Rec View	107
Registration	126
Remote shooting	122
Reset	98
Reset Lens	109
Rotation	91, 103

S

S (Shutter priority mode)	47
S-AF+MF (Single AF and Manual focus)	72
S-AF (Single AF)	72
Saturation	81
SCN (Scene)	29

SD card.....	133
Formatting the card.....	108
Self-timer	66
Sequential shooting.....	66
Setup Menu	107, 151
Share Order.....	94
Sharpness	80
Shooting Menu	98, 148
Shooting Menu 1.....	98
Shooting Menu 2.....	98
Shooting modes.....	24
Silent [♥]	37
Single AF	72
Sleep	18, 114
Slideshow	92
sRGB.....	84
Storage	125
Super Spot AF	87

T

Time Lapse Movie	100
Time lapse shooting	100
Time photography.....	49
Touch AF.....	51
Touch screen operations	51, 96
Touchscreen Settings	114
Trimming	
JPEG image.....	104
Movie	106
TV	118

U

USB connection.....	125
USB Mode	110

V

Video Bit Rate.....	74, 102
Video Frame Rate	74, 102
Video Menu	102, 148
Volume adjustment.....	93

W

WB.....	112
White balance.....	70
White balance compensation	79

Wi-Fi connection method.....	123
Wi-Fi Settings	107, 123

Z

Zoom frame AF.....	87
--------------------	----

OLYMPUS KOREA CO., LTD.

Olympus Tower A, 446, Bongeunsa-ro, Gangnam-gu, Seoul, Korea, 06153
Tel. 1544-3200
E-mail: hotline.okr@olympus-ap.com
<http://www.olympus.co.kr>

OLYMPUS (MALAYSIA) Sdn Bhd

512, 5th Floor, Block D, Kelana Square 17, Jalan SS 7/26, Kelana Jaya,
47301 Petaling Jaya, Selangor, Malaysia
Tel: (603) 7806 2173
Fax: (603) 7803 7164
E-mail: service.oml@olympus-ap.com
<http://www.olympus.com.my>

OLYMPUS (Thailand) CO., LTD.

23/112 Sorachai Building, 27th Floor, Soi Sukhumvit 63 (Ekamai)
Sukhumvit road Klongton Nua, Wattana, Bangkok 10110 Thailand
Tel: 662 787 8200
E-mail: imaging.oth@olympus-ap.com

OLYMPUS AMERICA INC.

3500 Corporate Parkway, P.O. Box 610, Center Valley, PA 18034-0610, U.S.A. Tel. 484-896-5000

Technical Support (U.S.A. / Canada)

24/7 online automated help:

<http://www.olympusamerica.com/support>

Phone customer support:

Tel. 1-800-260-1625 (Toll-free)

Our phone customer support is available from

9 am to 9 pm (Monday to Friday) ET

<http://olympusamerica.com/contactus>

Olympus software updates can be obtained at:

<http://www.olympusamerica.com/digital>

OLYMPUS EUROPA SE & CO. KG

Premises: Consumer Product Division

Wendenstrasse 14-18, 20097

Hamburg, Germany

Tel: +49 40-23 77 3-0 / Fax: +49 40-23 07 61

Goods delivery: Modul H, Willi-Bleicher Str. 36,

52353 Düren, Germany

Mailing address: Postfach 10 49 08,

20034 Hamburg, Germany

European Technical Customer Support:

Please visit our homepage <http://www.olympus-europa.com> or call our TOLL FREE NUMBER* : **00800 - 67 10 83 00**

for Austria, Belgium, Denmark, Finland, France, Germany, Luxemburg, Netherlands, Norway, Poland, Portugal, Spain, Sweden, Switzerland, United Kingdom.

810-800 67 10 83 00 for Russia

800 167 777 for Czech Republic

* Please note some phone service providers do not permit access to 00800 numbers or require an additional prefix. Charges may apply here. Please contact your service provider directly for more details.

For all not listed European Countries and in case that you can't get connected to the above mentioned number, please make use of the following CHARGED NUMBERS **+49 40 - 237 73 899**

OLYMPUS (CHINA) CO.,LTD.

Customer Support: 400-650-0303 Homepage: <http://olympus-imaging.cn>

Customer Service Center:

10F, K, Wah Centre, 1010 Huaihai Road(M), Xuhui District, Shanghai

Zip: 200031

OLYMPUS HONG KONG AND CHINA LIMITED

Digital Camera Repair Centre

L4207, Office Tower, Langham Place, 8 Argyle Street, Mongkok, Kowloon, Hong Kong

Customer Hotline: +852-2376-2150 Fax: +852-2375-0630

E-mail: cs.ohc@olympus-ap.com

<http://www.olympus.com.hk>