

playmobil®



IAN



70624

DAS ULTIMATIVE DINO ABENTEUER

Gemeinsam mit seinen 5 Freunden begibt sich Ian auf eine Heldenreise in der sie längst ausgestorbene Dinosaurier aus einem sagenumwobenen Felsen namens „Dino Rock“ befreien. Die gigantischen Tiere verbünden sich mit den Teenagern zu einem Team und rüsten sich mit Unterstützung von Uncle Rob zum Angriff. Gegen die bösen, menschengesteuerten Maschinen wird ein Kampf entfacht, um die Dinos zu schützen, zu verteidigen und zu retten.

THE ULTIMATE DINO ADVENTURE

Together with his five friends, Ian embarks on a heroic journey, in which they discover long-extinct dinosaurs at a legendary rock called "Dino Rock".

The gigantic animals team up with the teenagers and prepare for attack with the help of Uncle Rob. A battle commences against the evil, human-controlled machines to protect, defend, and save the dinos.

LA DERNIERE AVENTURE DINO

Ian et ses 5 amis sont plongés dans une aventure extraordinaire ! Ils y découvrent un mystérieux rocher appelé "Dino Rock" et libèrent des dinosaures disparus depuis longtemps ! Ces gigantesques animaux rejoignent l'équipe de Ian avec le soutien de Uncle Rob. Ils préparent une bataille contre les terribles machines contrôlées par l'Homme. Ian et ses amis vont tout faire pour protéger, défendre et sauver leurs amis les dinosaures.

LA ÚLTIMA AVENTURA DE LOS DINOSAURIOS

Junto con sus 5 amigos, Ian se embarca en un viaje heroico en el que descubren dinosaurios, hace tiempo extinguidos, de una roca legendaria llamada "Dino Rock".

Los gigantes animales se unen a los adolescentes en un equipo y se preparan para atacar con el apoyo del Uncle Rob. Se libra una batalla contra las malvadas máquinas controladas por los humanos para proteger, defender y salvar a los dinosaurios.

IAN

Der Auserwählte:

- Cooler Teamleader
- Impulsiv
- Steht auf Abenteuer
- Siegessicher

The Chosen One:

- Cool team leader
- Impulsive
- Likes adventure
- Confident of victory

l'élite:

- Chef d'équipe cool
- Impulsif
- Aime l'aventure
- Confiant en sa victoire

El elegido:

- Un líder genial
- Impulsivo
- Le encanta la aventura
- Confiado de victoria

Dino-Wappen:

Symbolisiert das Dino-Team

Dino Crest:

Represents the dino team

Crête de Dino:

Symbolise l'équipe dinosaure

Dino Cimera:

Simboliza el equipo dino



T-Rex



Teampartner von Ian

lan's partner

Partenaire d'Ian

Compañero de equipo
de Ian

Titanharte Rüstung mit Katapult, welches T-Rex auslösen kann

Titanium hard gear with catapult that
can be triggered

Armure rigide en titane avec catapulte,
que T-Rex peut déclencher

Dura armadura de titanio con catapulta,
la cual el T-Rex puede disparar

NEU new
Nouveau
nuevo



Aufbauen leicht gemacht. Viel Spaß
mit deinem neuen PLAYMOBIL-Spielzeug!

Assembly made easy. Have fun
with your new PLAYMOBIL toy!

Assemblage simplifié. Amuse-toi
avec tes nouveaux PLAYMOBIL!

Montaje fácil. ¡Diviértete con tu nuevo
juguete de PLAYMOBIL!





WARNING:
CHOKING HAZARD

Small parts. Not for children under 3 years.

"Ne concerne que les USA"



ASSEMBLY INSTRUCTION



1



2

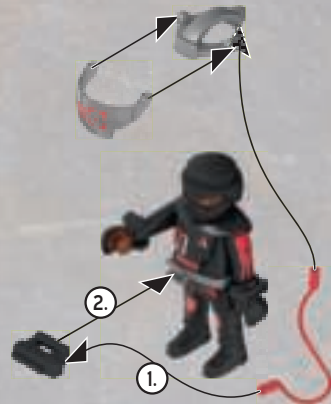



1

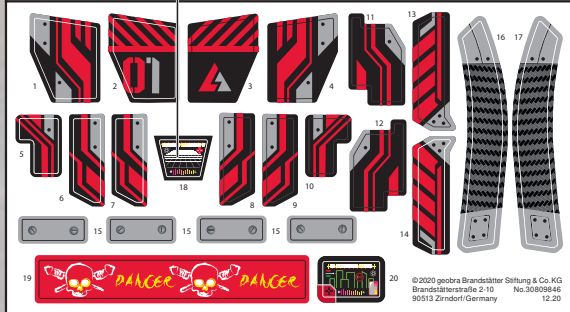
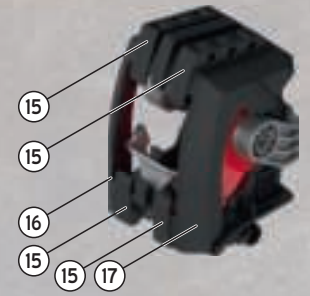

ASSEMBLY INSTRUCTION

2

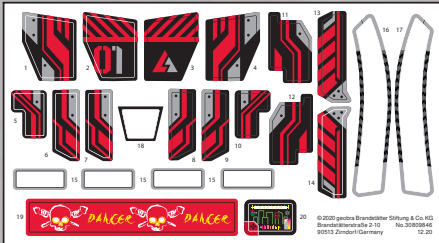
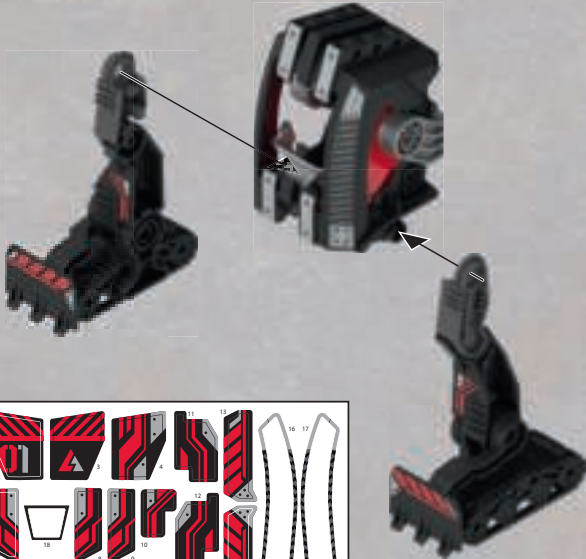
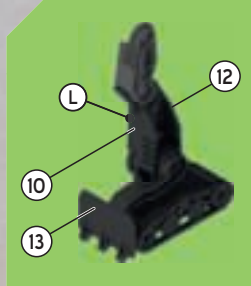
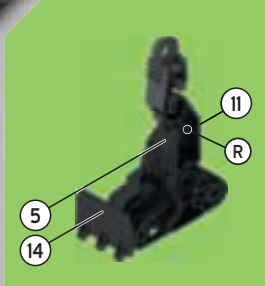

3

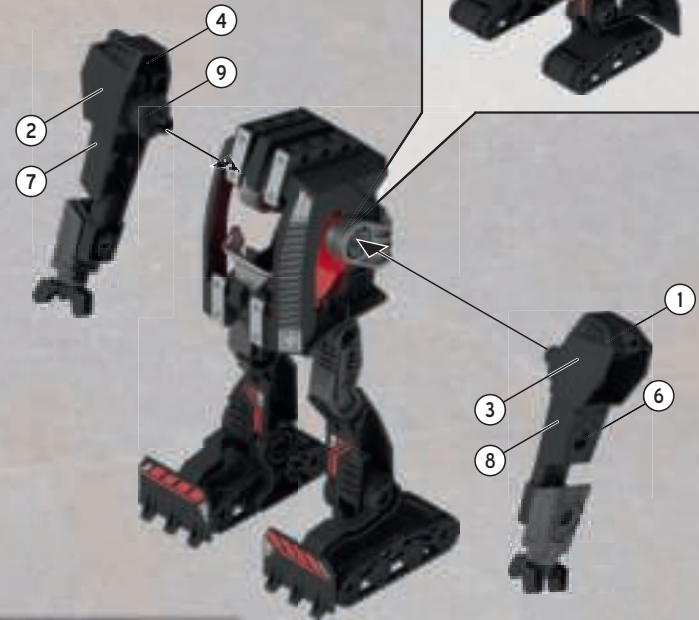

1

2x

1

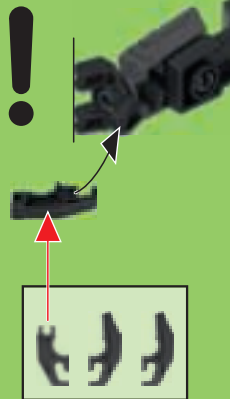

2

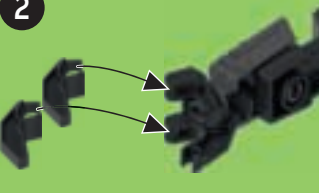

4



2



3

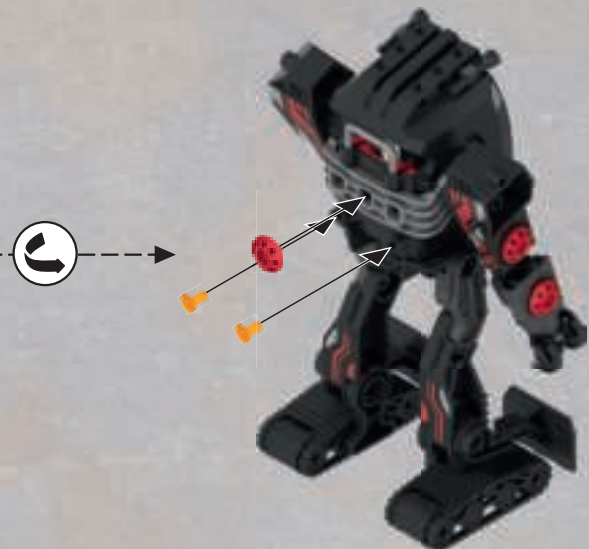

4

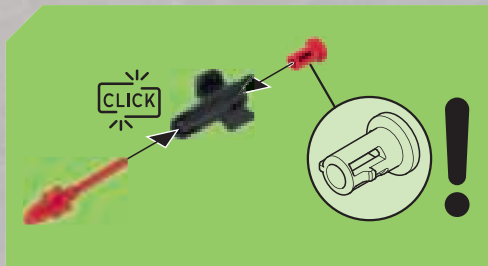

5

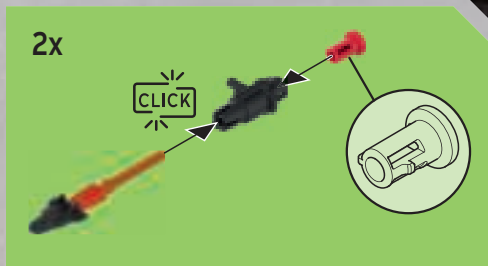



1



2x 1

2



20

19 **DANCER** **DANCER** 20

© 2007 Spinora Brandstätter Stiftung & Co. KG
 Brandenburgerstraße 21/22 · Tel. 36032944
 90513 Zornhof · Germany 12.20

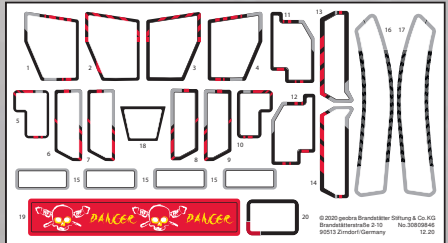
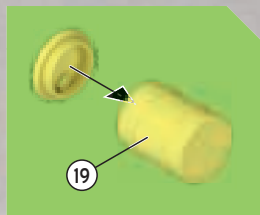

© 2020 Jendira Brandstetter Stiftung & Co. KG
 Brandstetterstraße 2-10 · 76639 Bruchsal
 95013 Zirndorf/Germany



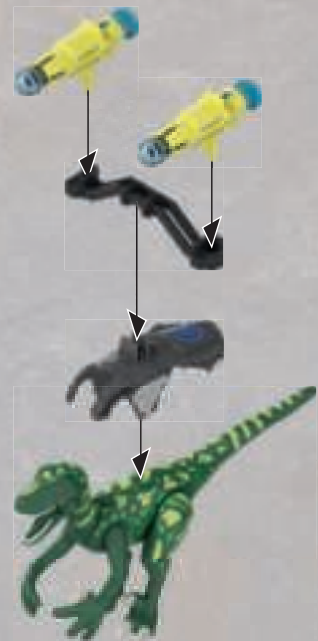
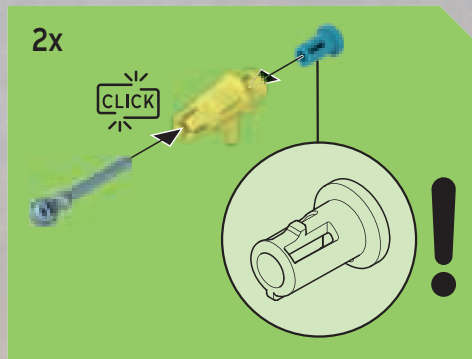

DE AT CH LU BE **ACHTUNG!** Nur mitgelieferte PLAYMOBIL Geschosse verwenden. Nicht auf Augen oder Gesicht zielen.

US GB CA MT IE **WARNING!** Only use the PLAYMOBIL projectiles supplied. Do not aim at eyes or face.

FR CA BE LU CH **ATTENTION!** Seulement utiliser les projectiles PLAYMOBIL fournis. Ne pas viser les yeux ou le visage.

ES MX **¡ADVERTENCIA!** Utiliza únicamente los proyectiles PLAYMOBIL suministrados. No apuntar a los ojos ni a la cara.

NL BE **WAARSCHUWING!** Uitsluitend meegelieferde PLAYMOBIL delen gebruiken. Niet op ogen of gezicht richten.

IT CH **AVVERTENZA!** Usare soltanto i proiettili PLAYMOBIL in dotazione. Non mirare agli occhi o al viso.

PT **ATENÇÃO!** Usar apenas os projéteis PLAYMOBIL juntamente fornecidos. Não apontar para os olhos ou face.

DK **ADVARSEL!** Anvend kun de medfølgende PLAYMOBIL projektiler. Sig ikke mod øjne eller ansigt.

NO **ADVARSEL!** Benytt kun PLAYMOBIL prosjektil som leveres med. Sik ikke på ansikt eller øyne.

SE FI **VARNING!** Använd endast medföljande PLAYMOBIL-skott. Sik inte mot ögon eller ansikte.

FI **VAROITUS!** Käytä vain mukana toimitettuja PLAYMOBIL-ammuksia. Ei saa kohdistaa suoraan silmiin tai kasvoihin.

HU **FIGYELMEZTETÉS.** Csak a csomagban található PLAYMOBIL lövedékeket szabad használni. Tilos szemre vagy arcra célozni.

CZ **UPOZORNĚNÍ!** Používejte pouze střely PLAYMOBIL, které jsou součástí dodávky. Nemiřte na oči nebo na obličej!

EE **HOIATUS!** Kasutage ainult kaasaantud PLAYMOBIL'i laske muna. Ära sihi silmadesse ega näkku.

LV **BRIDINĀJUMS!** Izmantot tikai PLAYMOBIL piegādes komplektā iekļautos šāviņus. Nevērst pret acīm vai seju.

LT **ĮSPĖJIMAS!** Naudokite tik pridedamus PLAYMOBIL šaudmenis. Netaikyti į akis arba veidą.

SI **OPOROZILO!** Uporabljajte le priložene PLAYMOBIL-ove kroglice. Ne merite v oči ali obraz.

SK **UPOZORNENIE!** Používajte len náboje dodávané spolu so sadou PLAYMOBIL. Nemieriť do očí alebo do tváre.

PL **OSTRZEŻENIE!** Stosować tylko załączone PLAYMOBIL - kule / pociski. Nie celować w oczy i twarz.

TR CY **DIKKAT!** Sadece birlik verilen PLAYMOBIL mermileri kullanınız. Göze veya yüze doğru tutmayın.

GR CY **Προειδοποίηση!** Να χρησιμοποιούνται αποκλειστικά τα βλήματα της PLAYMOBIL που περιέχονται στη συσκευασία. Μη γίνετα στόχευση στα μάτια ή στο πρόσωπο.

RO **AVERTISMENT!** Se folosesc doar proiectilele incluse în setul PLAYMOBIL. Nu se țintește în ochi sau în față.

BG **Внимание!** Използвайте само приложени PLAYMOBIL снаряди. Не насочвайте към очите и лицето.

HR **UPOZORENJE!** Upotrijebiti samo od strane PLAYMOBIL-a isporučene projekte. Ne ciljati u oči ili lice.

RU **Внимание!** Используйте только поставляемые в комплекте снаряды PLAYMOBIL. Не целитесь в глаза или в лицо.

CN **警告!** 仅能用PLAYMOBIL 弹射物, 请勿瞄准眼睛或脸.

(说明书上含有重要信息, 请保留备用)





30 66 4604

30 00 0099

30 66 4684

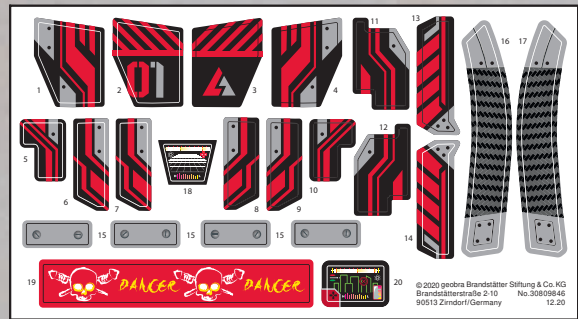

30 80 9846

© 2020 geobra Brandstätter Stiftung & Co. KG
 Brandstätterstraße 2-10 No. 30009946
 90513 Zirndorf / Germany No. 30009946
 12.20



1

playmobil

30 63 2107

30 63 2117

30 02 1924

2x 30 02 1904

30 02 1914



2

playmobil



30 00 9664

30 02 1174



30 63 9037

30 02 1994

2x 30 23 7640



30 23 0682

3



pliny mobilis



30 66 4704



2x 30 66 4714



30 66 4724



30 66 4744

4



pliny mobilis



30 02 6114



3x 30 02 6104



2x 30 02 6124



30 24 2723



2x 30 02 6094



2x 30 21 6602



4x 30 02 6084



2x 30 07 2632



2x 30 07 4342

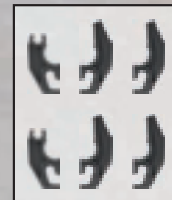

30 51 2303



30 63 2207



30 02 6144



30 02 6134



30 63 2227

R



30 63 2237

L



2x 30 02 5392



2x 30 21 3380



2x 30 06 6473



30 02 6164



3x 30 04 8822



30 63 2217



2x 30 02 6194



30 02 6174



4x 30 02 6204



4x 30 09 2332



30 61 2522



30 63 2247



30 02 6224



2x 30 02 6204



2x 30 02 6234



2x 30 02 6244

UK-Importer:
Playmobil UK Ltd.
Regency House
1 Miles Gray Road
Basildon
Essex
SS14 3RW
UK

UK
CA

Wichtige Unterlagen, bitte sorgfältig aufbewahren!
Important: Please keep these instructions for future reference!
Documents importants, à conserver soigneusement!
¡Por favor, guarde estas instrucciones para el futuro!
Belangrijke documenten, bewaar deze zorgvuldig!

Abbildungen können vom Original abweichen.
Product may differ from image shown.
Les illustrations peuvent différer de l'original.
Las ilustraciones pueden diferir del original.
Afbeeldingen kunnen verschillen van het werkelijke artikel.

Serviceadressen finden Sie in allen
PLAYMOBIL-Prospekten

Addresses of Customer Service Depart-
ments are shown in all PLAYMOBIL
catalogues

L'adresse du service consommateurs
est indiquée dans tous les catalogues
PLAYMOBIL

Troverete gli indirizzi dei centri di
assistenza in tutti i cataloghi PLAYMOBIL

In alle PLAYMOBIL catalogi vindt u
het adres van onze klantendienst.

Las Direcciones de los Departamentos
de Servicio al Consumidor se encuentran
en todos los catálogos PLAYMOBIL

Η διεύθυνση του Γραφείου Εξυπηρέτησης
Καταναλωτών PLAYMOBIL βρίσκεται σε
όλους τους καταλόγους PLAYMOBIL.

pronounced: plāymō-bēēl



✓ 70624



● 70626



● 70623



● 70625



● 70629



● 70693



● 70628



● 70627

Watch it on
YouTube and
YouTube Kids



Actiongeladene Dino-Abenteuer **jetzt auch als Serie!**
Folge uns auf unseren Social-Media-Kanälen.

Continue les aventures des dinosaures avec notre
nouveau dessin animé!
Disponible sur nos réseaux sociaux !

Action-packed dino adventures, **now also a series!**
Follow us on social media for exciting updates.

Aventuras de dinosaurios llenas de acción **¡ahora también como una serie!**
Síguenos en nuestros canales de redes sociales.

www.playmobil.com



©2020 geobra Brandstätter Stiftung & Co. KG
Brandstätterstr. 2-10
90513 Zirndorf, Germany
No. 30 80 9916 03.21

