

PHILIPS

hue personal
wireless
lighting

17466/**/P7



HUE serial number



User manual
Benutzerhandbuch
Notice d'emploi
Manual de usuario
Manual do usuário
Manuale d'uso

Incl.

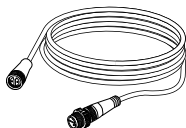
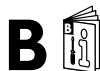

Excl.

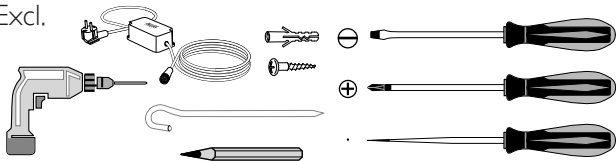

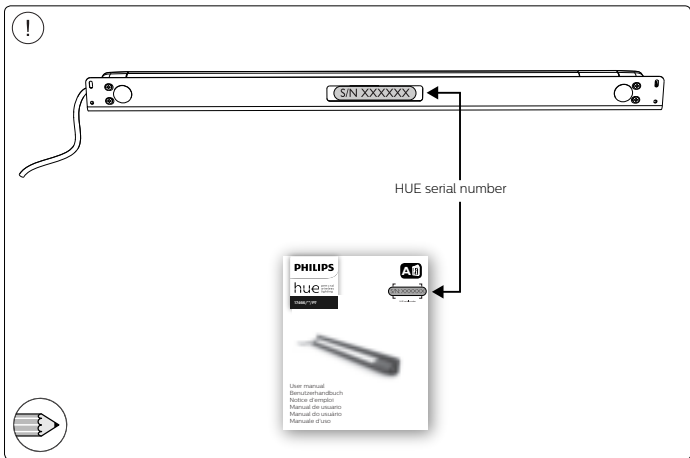

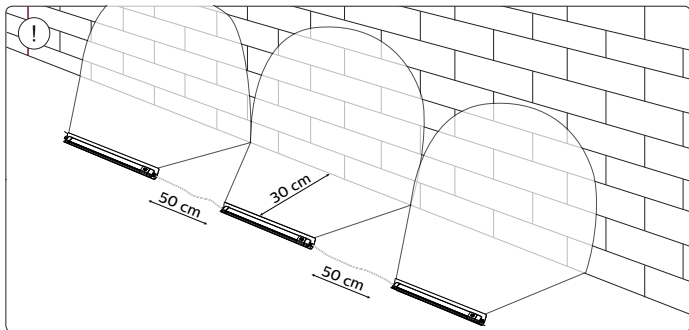
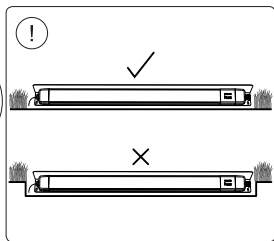
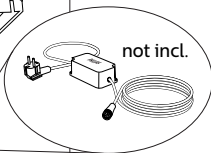
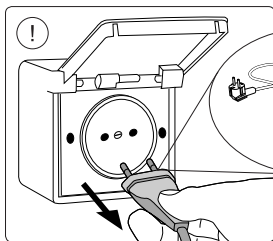

1a

1a → 2

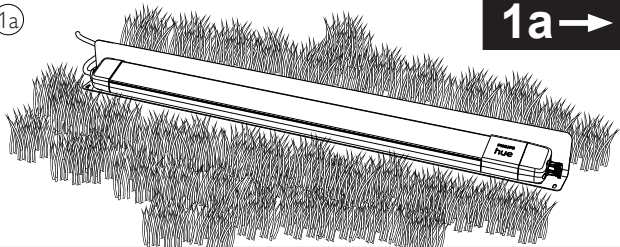

1b

1b → 3

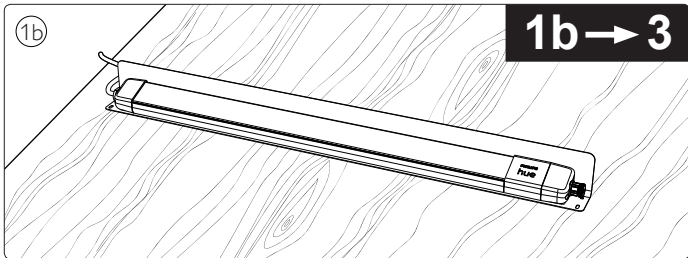

2 → 6

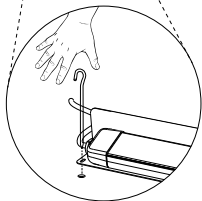
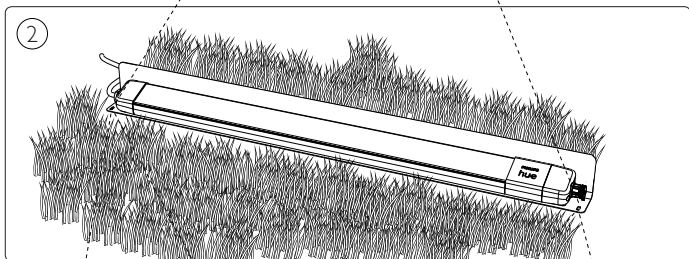
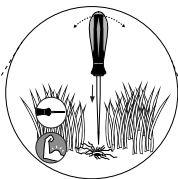

2b

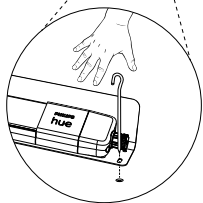

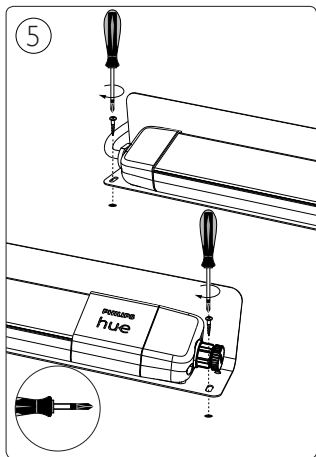
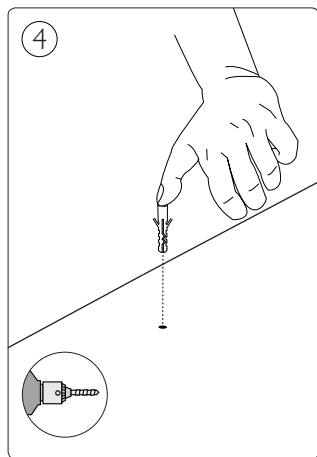
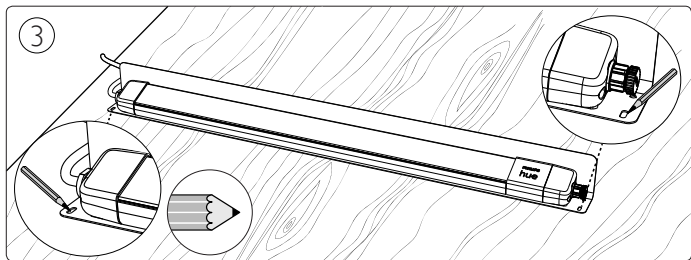

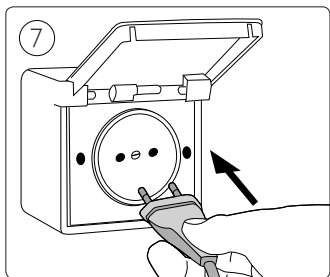
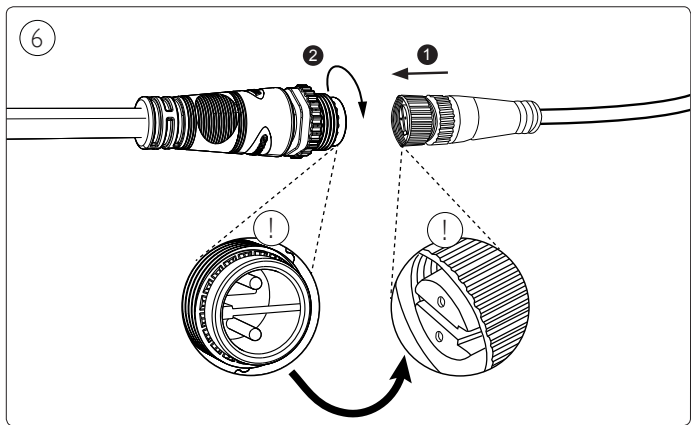

?

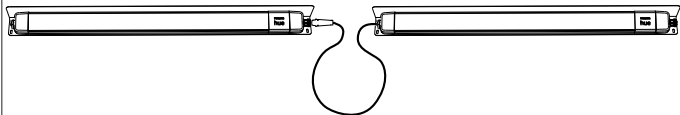

1

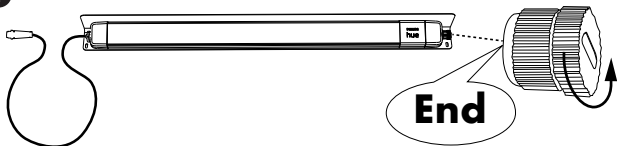

2

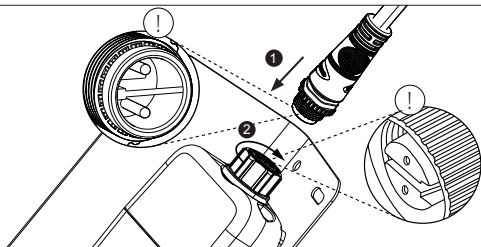

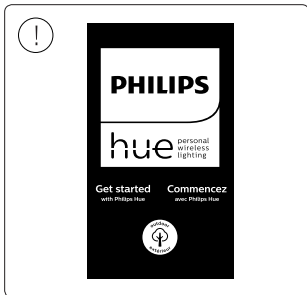

www.philips-hue.com/getstarted



- EN** Use only with Philips Hue 24V **==**SELV IP67 LED power supply!
- DE** Verwendung nur mit Philips Hue 24V **==**SELV IP67 LED-Stromversorgung!
- FR** Utiliser uniquement avec l'alimentation LED Philips Hue 24V **==**SELV IP67!
- ES** Se utiliza solo con la fuente de alimentación LED Philips Hue SELV 24V **==**IP67!
- PT** Utilize apenas com fonte de alimentação LED SELV Philips Hue de 24V **==**IP67!
- IT** Da utilizzare solo con un alimentatore LED Philips Hue 24V **==**IP67!

Low Voltage system

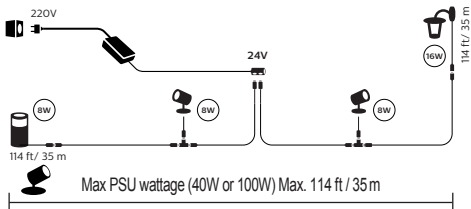



Signify
I.B.R.S. / C.C.R.I. Numéro 10461
5600 VB Eindhoven,
the Netherlands
☎00800-74454775

Signify Australia Limited
65 Epping Road, North Ryde,
NSW, 2113 Australia
Toll Free number: 1300 304 404

Signify New Zealand Limited
123 Carlton Gore Road
Newmarket, Auckland 1023
New Zealand
Tel: 0800 454 448

© 2020 Signify Holding
All rights reserved.

www.philips-hue.com

4404 029 13351
Last update: 08/2020