

SENCOR®

SPV 7771DUAL
SPV 7971DUAL
PORTABLE DVD PLAYER

DVD

USER'S MANUAL

EN

Table of Contents

Safety Precautions	2
Introduction.....	5
Description of player.....	7
Main unit	7
Side unit	7
Remote control	8
Insert the battery.....	10
SETUP Menu Setting	11
General Setup Page	11
Audio Setup Page.....	11
Video Setup Page.....	12
Preference Setup Page	13
Password Setup Page	13
Settings menu of the side unit	15
Parameters and specifications.....	16
Maintenance and Service.....	17
Troubleshooting tips	18

Before connecting, operating or adjusting this product, please read this user’s manual carefully and completely – contains important information for safe and optimal use of all features and functions. Store the user’s manual in case you need it again.

Appendix to LCD Instruction Manual

Precautions When Still Image is Displayed, Red/Blue/Green/Black spots on the screen

A still image may cause permanent damage to screen

- Do not display still image on the LCD panel for more than 2 hours as it can cause screen image retention. This image retention is known as "screen burn". To avoid such image retention, reduce the degree of brightness and contrast of the screen during still image watching.
- Similar "screen burn" effect can appear on the LCD panel due to still TV channel logo displaying.
- Watching TV in 4:3, 16:9 or similar modes which doesn't cover whole screen for long period of time may leave traces of borders displayed on the left, right or center of the screen caused by the difference of light emission on the screen. Playing a DVD or a game console can cause a similar effect to the screen.
- Displaying still images from video games and PC for longer than a certain period of time may produce partial after-images. To prevent this effect reduce the brightness and contrast when displaying still images.



Damage caused by above reasons is not covered by the Warranty!

There may appear red spots, blue spots, green spots and black spots on the screen

- This is a characteristic of liquid crystal panels and is not a problem. The liquid crystal panels are built with very high precision technology giving you fine picture details. Occasionally a few non-active pixels may appear on the screen as fixed point of red, green, blue or black (up to 0.001% of total display pixels). Please note this doesn't affect the performance of your LCD TV

Safety Precautions

CAUTION

RISK OF ELECTRIC SHOCK DO NOT OPEN

The device is a precision product taking advantage of the advances of modern electronics, mechanics and optics and requires corresponding handling. When handling the device adhere to the generally valid usage instructions for audiovisual technology products and devices including the following:



To prevent risk of injury through electric shock or the creation of a fire, do not take the device out of the case - there are no parts inside the case repairable or adjustable by the user without relevant equipment and qualifications. Should the device require adjustment or repair, contact a professional service centre.



Protect the device against rain, spray or contact with any other liquid, do not leave or install the device outdoors. Not adhering to this instruction creates a risk of electrical shock or fire hazard.



The player uses a low power class 1 laser beam. Do not remove the player from the device, do not turn the player when it is out of the device - after unblocking the protection and switching on the player there is risk of permanent eye damage by the laser radiation. During standard use of the player according to the instructions in the user's manual the player does not present any risks even for its direct vicinity.



Leave free space on all sides of the device, which is necessary for proper air circulation around the device - in this way hot air created during its operation is removed. Covering the ventilation opening of the devices case creates a risk of overheating or damaging the device.



Before allowing children to use the device, they must be appropriately to their age, informed about the correct and safe use of the player.



In the case of any unusual events occurring during the use of the player such as for example a sudden interruption of the video and/or sound, or the screen or control buttons turn off, or there is a distinct smell of burning insulation or smoke comes out of the device, immediately turn off the device, disconnect the device from the power source and do not use the device until you have received the results of the inspection from the employees of the professional service centre.



To recharge the battery block that is integrated into the device, place the device in a well ventilated place and at a sufficient distance from easily flammable materials.

Safety Precautions



Neither the manufacturer nor the seller of the device under no condition takes responsibility for any direct or indirect damages caused by not adhering to instructions for installation, setup, use, service or cleaning of this device as described in this user's manual.



Protect the device against being knocked, dropped, hit, shaken and against vibrations, humidity and dust.



Do not install the device in direct sunlight or in the vicinity of a heat source - high temperatures substantially reduce the lifetime of the device's electronic components. Do not use or leave the device in the vicinity of an open fire.



When the device is moved from a cold to a warm environment or vice versa, e.g. when using the device in a very humid environment, air humidity may condense on some parts inside the case of the device, namely on the sensing system and the player may temporarily stop functioning. When possible condensation of air humidity in the player occurs, remove the disc from the player and then leave the player on undisturbed for 1 - 2 hours - the humidity will evaporate and the device can again be used as usual. Take care especially during the first use of the player immediately after its purchase during a cold season.

IMPORTANT SAFETY INSTRUCTIONS:

THE POWER PLUG IS USED AS A DISCONNECTING DEVICE, WHICH MUST FOR THIS REASON REMAIN EASILY ACCESSIBLE.

DO NOT EXPOSE THE DEVICE TO THE EFFECTS OF DRIPPING OR SPRAYING WATER AND DO NOT PLACE THE DEVICE ON OBJECTS FILLED WITH A LIQUID (E.G. VASES).

THE DEVICE'S CONNECTOR IS USED AS A DISCONNECTING DEVICE, WHICH MUST FOR THIS REASON REMAIN EASILY ACCESSIBLE.

REMEMBER TO ALWAYS DISCONNECT THE POWER PLUG FROM THE POWER SOCKET BEFORE DISCONNECTING THE POWER CABLE FROM THE BACK SIDE OF THE DEVICE.

AN OPEN FLAME MUST NOT BE PLACED ON THE DEVICE, E.G. A BURNING CANDLE.

PAY SPECIAL ATTENTION TO THE BATTERIES USED AS REGARDS TO THE ENVIRONMENT.

THE VENTILATION MUST NOT BE IMPEDED BY COVERING THE VENTILATION OPENINGS WITH OBJECTS SUCH AS NEWSPAPERS, TABLECLOTHS, CURTAINS, ETC.

Notes on Copyrights:

- It is forbidden by law to copy, broadcast, show, broadcast via cable, play in public, or rent copyrighted material without permission.
- This product features the copy protection function developed by Macrovision. Copy protection signals are recorded on some discs.
- When recording and playing the pictures of these discs picture noise will appear.
- This product incorporates copyright protection technology that is protected by method claims of certain U. S. Patents and other intellectual property rights owned by Macrovision Corporation and other rights owners.
- Use of this copyright protection technology must be authorized by Macrovision Corporation, and is intended for home and other limited viewing uses only unless otherwise authorized by macrovision Corporation. Reverse engineering or disassembly is prohibited.

Safety Precautions

SERIAL NUMBER:

You can find the serial number on the back of the unit. This number is unique to this unit and not available to others. You should record requested information here and retain this guide as a permanent record of your purchase.

Model number _____

Serial number _____

Purchase date _____



This item incorporates copy protection technology that is protected by U.S. patents and other intellectual property rights of Rovi Corporation. Reverse engineering and disassembly are prohibited.

Due to wide offer of USB devices/SD/MC/MMS cards on the market, we do not guarantee full compatibility of the device with all types USB sticks/SD/MC/MMS cards.

Caution: Before using the player, please ensure that the local AC voltage is suitable for this unit.

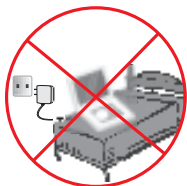

charge



strong impact



over heat 40 °C

Introduction

The user's manual contains information and instructions for the correct installation, connection, setup, operation and service of this device.

- The identification of buttons, connectors, and other control and connection elements of the player are described using CAPITAL LETTERS in the user's manual.
- For all text information displayed on the screen of the player or on the screen of the connected television the user's manual uses **bold letters**.

This manual provides information on the operation and maintenance of your DVD player. Should the unit require service, contact an authorized service location.

Symbol Used in this Manual



The lightning flash symbol alerts you to the presence of dangerous voltage within the product enclosure that may constitute a risk of electric shock.



The exclamation point alerts you to the presence of important operating and maintenance/servicing instructions.



Indicates hazards likely to cause harm to the unit itself or other material damage.

Note:

Indicates special notes and operating features.

Tip:

Indicates tips and hints for making the task easier. A section whose title has one of the following symbols is applicable only to the disc represented by the symbol.

 DVD and finalized DVD±R/RW

 Video CDs

 Audio CDs

 MP3 Discs

 JPEG Discs



may appear on your TV display during operation and indicates that the function explained in this owner's manual is not available on that specific DVD video disc.

Notes on Discs

Handling Discs

- Do not touch the playback side of the disc. Hold the disc by the edges so that fingerprints do not get on the surface. Never stick paper or tape on the disc – for labelling discs use special soft tip markers designed for this use, write on the side of the disc with the label.



After playing, store the disc in its case. Do not expose the disc to direct sunlight or source of heat and never leave it in a parked car exposed to direct sunlight or near a heat source, do not leave discs in closed vehicles parked in direct sunlight. Risk of disc deformation.



Introduction

Cleaning Discs

- Fingerprints and dust on the disc can cause poor picture quality and sound distortion. To remove them wipe the disc with a soft lint free cloth before playing. When cleaning the disc proceed from the centre directly to the edge (not in circular motion).



- Do not use vinyl record anti-static sprays, petrol, ethanol or other solvents or thinners.

	DVD (8 cm/12 cm disc)
	Video CD (VCD) (8 cm/12 cm disc)
	Audio CD (8 cm/12 cm disc)

Apart from the above mentioned disc types it is possible to play DVD+/-R, DVD+/-RW, Kodak Picture CD, SVCD, CD-R with recordings in CD format (CD audio copy), CD-R with compressed music files in formats MP3, CD-R with image files in the format JPEG. Playing of disc types not mentioned here is not guaranteed.

	This indicates a product feature that is capable of playing DVD-RW discs recorded with Video Recording format.
---	--

Notes:

- Depending on the recording media, recording method (used PC program used for the disc recording) and its finalisation, it is possible that it will not be possible to play some CD-R or DVD+/-RW/R discs.
- Do not attach any seal or label to either side (the labeled side or the recorded side) of a disc.
- Use the player to play only circular discs - when playing irregular shaped discs there is a risk of damaging the disc or the player.
- Some playback operations of DVDs and Video CDs may be intentionally programmed by software manufacturers. This unit plays DVDS and Video CDs according to disc content designed by the software manufacturer, therefore some playback features may not be available or other functions may be added.

Manufactured under license from Dolby Laboratories. „Dolby“, „Pro Logic“, and the double-D symbol are trademarks of Dolby Laboratories.

Region code



This player is designed for playing DVD video marked with region code 2 or ALL (discs labelled in this way can be played by all DVD players). The disc's region code is located on its label or cover, the player's region code is located on the back/bottom side of the player. After inserting a DVD with a different region code than mentioned above a message Check Region Code will be displayed on the screen and DVD playback will be rejected by the player.

Description of player

Main unit

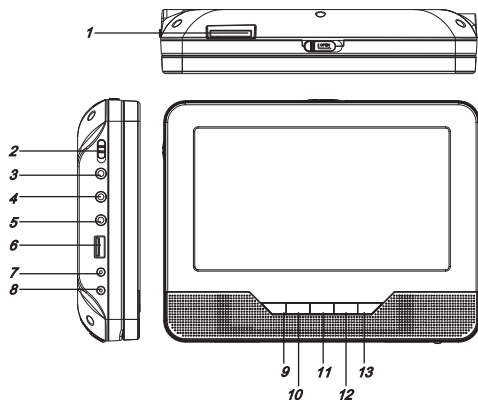

1. SD/MS/MMC
2. ON/OFF (Power switch)
3. (Headphone jack)
4. AV OUT (AV output)
5. COAXIAL (Digital audio output)
6. USB
7. DC OUT (Direct current power output 9 – 12V)
8. DC IN 9 – 12V connector (Direct current power input)
9. (Play / pause)
10. Previous / up
11. Down / next
12. (Stop)
13. SOURCE button (Source)

Side unit

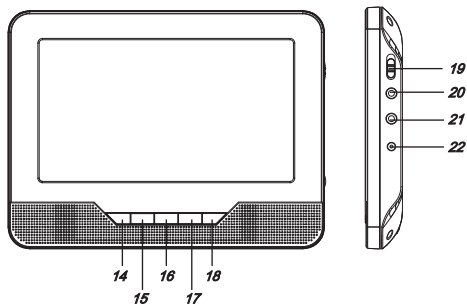

14. MODE (Mode) button
15. (Up)
16. (Down)
17. /VOL- (Left / decrease volume)
18. /VOL+ (Right / increase volume)
19. ON/OFF (Power switch)
20. AV IN (AV input)
21. (Headphone jack)
22. DC IN (Direct current power input 9 – 12 V)

Description of player

Remote Control

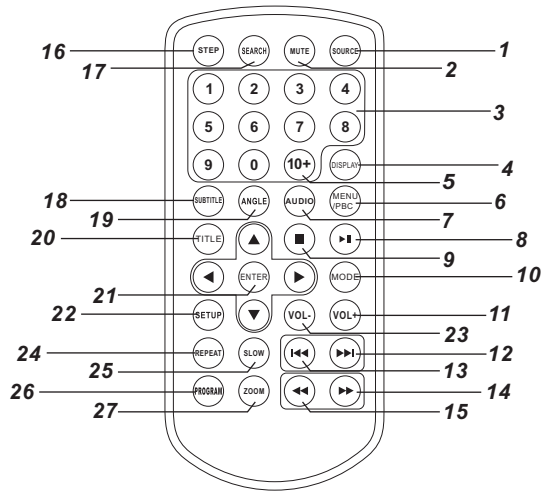

1. SOURCE button

DVD/CARD/USB.

2. MUTE button

Disable Audio output.

3. 0 – 9 Number buttons

Select numbered items in a menu.

4. DISPLAY button

Display the playtime and status information.

5. 10+ button

In order to select a track 10 or greater, first press 10+button. For example; select track 12, first press 10+, and then press button number 2.

6. MENU/PBC button

Return to DVD root menu (DVD).

PBC on/off switch. Only for VCD. For other discs, the function is invalid.

7. AUDIO button

DVD: Press AUDIO button repeatedly during playback to hear a different audio language or audio track, if available.

MP3 CD VCD: Press AUDIO button repeatedly during playback to hear a different audio channel (Left, Right, Mix, Stereo).

8. ►|| PLAY/PAUSE button

Press ►|| button once to pause playback, pressing ►|| button second time will resume the playback.

9. ■ STOP button

When ■ button is pressed once, the unit records the stopped point where the playback will resume if ►|| button is pressed after wards. But if ■ button is pressed again instead of ►|| button, there will be no resume function.

10. MODE button

Set LCD parameter (adjust brightness, contrast, saturation).

11. VOL + button

Increase volume.

12. ►►I button

Go to next chapter/track.

13. I◄◄ button

Go to the beginning of previous chapter/track.

14. ►► button

Press ►► button to allow skipping ahead at 5-level speed (X2 → X4 → X8 → X16 → X32 → PLAY), press ►|| button to return to normal playback.

Description of player

15. ◀◀ button

Press ◀◀ button to allow skipping back at 5-level speed (X2 → X4 → X8 → X16 → X32 → PLAY), press ▶▶ button to return to normal playback.

16. STEP button

Press STEP button once to pause playback. From this status, press STEP button to advance one video frame.

17. SEARCH button

Go to time point, title or chapter you want in DVD mode.

18. SUBTITLE button

Press SUBTITLE button repeatedly during playback to hear a different subtitle languages.

19. ANGLE button

DVD: Press ANGLE button will change the view angle, on DVDs that support this feature.

20. TITLE button

Return to DVD title menu.

21. ENTER button

Confirm menu selection.

22. SETUP button

Accesses or removes setup menu.

23. VOL- button

Decrease volume.

24. REPEAT button

Press REPEAT button during playback to select a desired repeat mode.

DVD: you can play a chapter/title/off.

VCD: you can play a single/all/off.

CD **MP3**: you can select repeat single/folder/off.

25. SLOW button

Press Slow button repeatedly to enter slow playback, and cycle between different speeds. The speeds are: 1/2, 1/4, 1/8, 1/16 and normal.

26. PROGRAM button

DVD **VCD**: The program function enables you to store your favourite tracks from the disc. Press PROGRAM button, then PROGRAM MENU will appear on screen, now you can use the number key to direct input the titles, chapters or tracks number and select PLAY option. To resume normal playback, press PROGRAM button and select CLEAR option on the program menu.

27. ZOOM button

Use ZOOM to enlarge or shrink the video image.

1. Press ZOOM button during playback or still playback to activate the Zoom function.
2. Each press of the ZOOM button changes the TV screen in the following sequence:
2X → 3X → 4X → 1/2 → 1/3 → 1/4 → normal size

JPEG: Use ZOOM to enlarge or shrink the picture.

1. Press ZOOM button.
2. Use ▶▶ button to enlarge, use ◀◀ button to shrink the picture. Use ▲/▼/◀/▶ buttons to move through the zoomed picture.

Description of player

Insert the battery

1. Open the battery door.
2. Insert battery.



Notes:

Remove battery during storage or when you are not using the DVD player for a long time.

To control the device using the remote control, point the remote control at the device and then press the button with the required function. The maximum range of the remote control is about 5 meters with a deviation of up to +/- 30° from the perpendicular direction to the reception sensor of the remote control on the front side of the device. The falling capacity of the batteries gradually reduces the remote control range.

- There must be no solid obstacles in the area between the remote control and the device when the remote control is being used.
- During standard use the lifetime of batteries in the remote control is about 1 year. When the effective range of the remote control is substantially reduced, or when there are problems with its use, change both the batteries in the remote control.
- If you will not be using the remote control for a longer period of time, take out both batteries from it - in this way you will prevent potential damage caused by their leakage.

The batteries must not be exposed to excessive heat, such as sun radiation, fire, etc.

The incorrect use of batteries may cause the leakage of the electrolyte and corrosion. To ensure that the remote control works correctly, proceed according to the instructions below:

- Do not insert the batteries in the wrong direction.
- Do not recharge, heat, open or short the batteries.
- Do not throw batteries into a fire.
- Do not leave discharged batteries in the remote control.
- Do not combine various types of batteries or new and old batteries.
- If you are not using the remote control for a longer period of time, remove the batteries to prevent potential damage caused by a subsequent battery leakage.
- If the remote control is not working correctly or its operational range is reduced, change all batteries for new ones.
- If electrolyte leaks out from the batteries, have the remote control cleaned by an authorised service centre.

Setup Menu Setting

Press SETUP button to enter the setup menu. Use direction buttons ▲/▼/◀/▶ to select the preferred item. After finishing settings, press SETUP button again to normal display. The following menu items can be changed:

GENERAL: Select the GENERAL SETUP PAGE menu.

AUDIO: Select the AUDIO SETUP PAGE menu.

VIDEO: Select the VIDEO SETUP PAGE menu.

PREFERENCE: Select the PREFERENCE SETUP PAGE menu.

PASSWORD: Select the PASSWORD SETUP PAGE menu.

General Setup Page

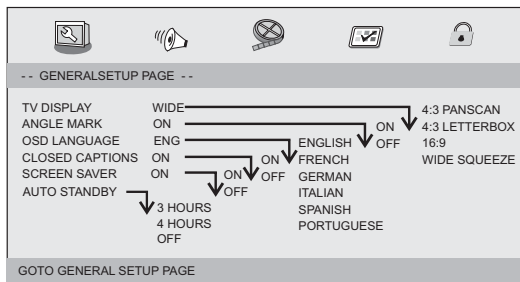

TV Display

Select the aspect ratio of the playback picture.

4:3 PANSKAN: If you have a normal TV and want both sides of the picture to be trimmed or formatted to fit your TV screen.

4:3 LETTERBOX: If you have a normal TV. In this case, a wide picture with black bands on the upper and lower portions of the TV screen will be displayed.

16:9: wide screen display.

Wide Squeeze: Set screen mode to 4:3.

Angle Mark

It displays current angle setting information on the right hand corner of the TFT screen if available on the disc.

OSD Language

You can select your own preferred language settings.

Closed Captions

Closed captions are data that are hidden in the video signal of some discs. Before you select this function, please ensure that the disc contains closed captions information and your TV set also has this function.

Screen Saver

This function is used to turn the screen saver On or Off.

Auto Standby (Automatic stand-by)

This function makes it possible to automatically put the device into standby mode after 3 or 4 hours.

3 HOURS (3 hours): The device will automatically go into standby mode after 3 hours have passed from the time that any button was pressed.

4 HOURS (4 hours): The device will automatically go into standby mode after 4 hours have passed from the time that any button was pressed.

OFF (Off): The automatic standby function will be deactivated.

Setup Menu Setting

Audio Setup Page

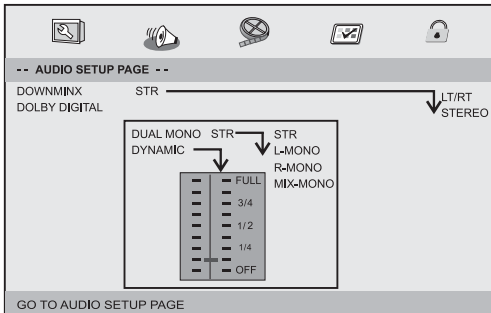

Downmix

This option allows you to set the stereo analog output of your DVD Player.

- **LT/RT:** Select this option if your DVD Player is connected to a Dolby Pro Logic decoder.
- **Stereo:** Select this option when output delivers sound from only the two front speakers.

Dolby digital

The options included in Dolby Digital Setup are: "Dual Mono" and "Dynamic".

Dual Mono

- **Stereo:** Left mono sound will send output signals to Left speaker and Right mono sound will send output signals to Right speaker.
- **L-Mono:** Left mono sound will send output signals to Left speaker and Right speaker.
- **R-Mono:** Right mono sound will send output signals to Left speaker and Right speaker.
- **Mix-Mono:** Left and Right mixed mono sound will send output signals to Left and Right speakers.

Dynamic

Dynamic range compression.

Video Setup Page

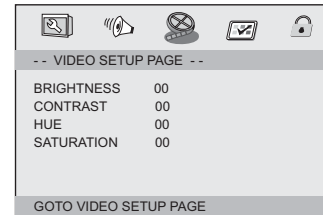

Set Sharpness, Brightness, Contrast, Hue, Saturation.

Setup Menu Setting

Preference Page

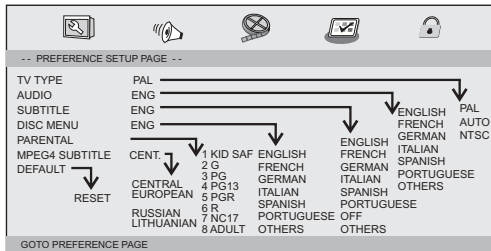

TV Type

Selecting the colour system that corresponds to your TV when AV outputs. This DVD Player is compatible with both NTSC and PAL.

- **PAL** - Select this if the connected TV is PAL system. It will change the video signal of a NTSC disc and output in PAL format.
- **NTSC** - Select this if the connected TV is NTSC system. It will change the video signal of a PAL disc and output in NTSC format.
- **Auto**: Change the video signal output automatic according to the playing disk format.

Audio

Select a language for audio (if available).

Subtitle

Select a language for subtitle (if available).

Disc Menu

Select a language for disc menu (if available).

Parental

Some DVDs may have a parental level assigned to the complete disc or to certain scenes on the disc. This feature lets you set a playback limitation level. The rating levels are from 1 to 8 and are country dependent. You

can prohibit the playing of certain discs that are not suitable for your children or have certain discs played with alternative scenes.

MPEG4 subtitle

Select the MPEG4 subtitle.

Default

Restore the factory setting.

Password Setup Page

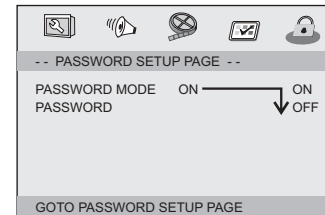

Password mode

Set password mode on/off. If set to off, change parental level will not check password.

Setup Menu Setting

Password

Select the menu password change page.

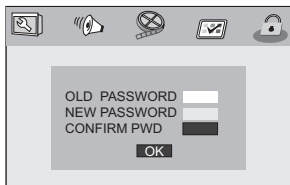

OLD PASSWORD: Enter the OLD password, (factory setting is 1369), and the cursor will jump automatically to NEW PASSWORD.

NEW PASSWORD: Enter the NEW password. Enter 4 digits from the remote control unit numeric buttons, and the cursor will automatically jump to CONFIRM PASSWORD.

CONFIRM PASSWORD: Confirm the NEW password by entering it again. If the confirmation is incorrect, the cursor will stay in this column. After entering, the correct new password again, the cursor will jump automatically to OK.

OK: When cursor is on this button, press ENTER button to confirm setting.

Note:

If the password has been changed, the parental and disc lock code will also be changed. The default password (1369) is always active even the password has been changed.

Settings menu of the side unit

Picture (Picture)

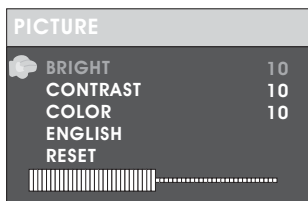

Brightness (Brightness)

Set the brightness of the screen.

Contrast (Contrast)

Set the contrast of the screen.

Color (Colours)

Set the colours of the screen.

English (Language)

Set the OSD language.

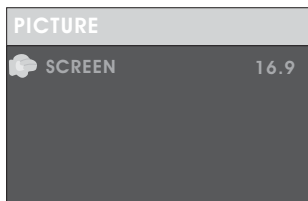

Screen (Screen)

Set the side aspect ratio 16:9 or 4:3.

Parameters and specifications

Device parameters

Item		Standard requirements
Power requirements		AC 100 – 120 V, 50/60 Hz
Power consumption		< 15 W
Operating humidity		5 % to 90 %
Output	VIDEO OUT	1 Vp-p (75 Ω)
	AUDIO OUT	1 Vp-p (1 KHz, 0 dB)
	Audio	Speaker: 2 x 1W, headphones output, coaxial output

System

Laser	Semiconductor laser, wave length 650 nm
Signal system	NTSC / PAL
Frequency response	20 Hz to 20 kHz (1 dB)
Signal – to – noise ratio	More than 80 dB (ANALOGUE OUT connectors only)
Dynamic range	More than 85 dB (DVD/CD)

Note:

Design and specifications are subject to change prior notice.

Battery Parameters

Battery Specifications

Output: 7.4 V

Charge/Discharge Time

Standard charge time: 3h – 4h

Storage and work circumstances

1. Storage circumstances	Temperature	Humidity	
	6 months	-20 C – +45 C	65 ± 20%
	1 week	-20 C – +65 C	65 ± 20%
2. Work circumstances	Temperature	Humidity	
	Standard charge	0 C – +45 C	65 ± 20%
	Standard discharge	-20 C – +65 C	65 ± 20%

Maintenance and Service

Refer to the information in this chapter before contacting a service technician.

- Protect the device against shocks of being hit or dropped
- We recommend that at least for the device's warranty period you keep the box and the packaging material. If transporting the device, pack it up in the same way as it came from the factory.
- Keeping the exterior surfaces clean.
- Do not use sprays or volatile solvents near the device.
- Do not leave the device in contact with rubber or plastic for a long time - risk of hard to remove stains. Do not use volatile substances in the vicinity of the device, e.g. insecticides.
- To clean the device use a soft cloth, if the device is dirtier then you can use a damp cloth with a lukewarm mild detergent solution.
- Do not use thinners or solvents - they may damage the surface treatment of the device's case.
- We recommend having the player professionally inspected and cleaned after 1000 operational hours (depending on conditions even sooner).

The DVD player is a high-tech, precision device. If the optical pickup lens and disc drive parts are dirty or worn, the picture quality could be diminished. Depending on the operating environment, regular inspection and maintenance are recommended after every 1000 hours of use. For details, please contact your nearest authorized service centre.

Troubleshooting tips

Troubleshooting tips (Common)

- Before calling for service, you can check the following items on symptoms and solutions.

No sound or distorted sound:

- Ensure that the equipment is connected properly.
- Ensure that the input settings for the TV and stereo system are proper.

No picture:

- Ensure that the equipment is connected properly.
- Ensure that the input setting for the TV is „video“.
- Ensure that the LCD is on.

No play:

- Condensation has formed: wait about 1 to 2 hours to allow the player to dry out.
- This player can't play discs other than DVDs, MP3s and CDs.
- The disc may be dirty and require cleaning.
- Ensure that the disc is installed with the label side up.

No remote control:

- Check the batteries are installed with the correct polarities (+&-).
- The batteries are depleted: replace them with new ones.
- Point the remote control unit at the remote control sensor and operate.
- Remove the obstacles between the remote control unit and the remote control sensor.
- Operate the remote control unit at a distance of not more than 8 meters from the remote control sensor.

No key operation (by the unit and/or the remote control) is effective:

- Turn the unit off and then back to on. Alternatively, turn off the unit, disconnect the AC power cord and the re-connect it.
(The player may not be operating properly due to lightning, static electricity or some other external factor.)

Battery does not work

- Check whether the battery is out of power or in proper connection.

Troubleshooting tips (DVD)

Play does not commence even when title is selected:

- Confirm the „Rating“ settings.

Audio soundtrack and/or subtitle language is not the one selected at the initial settings:

- If the audio soundtrack and/or subtitle language does not exist on the disc, the language selected at the initial setting will not be seen/heard.

No subtitles:

- Subtitles appear only with discs which contain them.

Alternative audio soundtrack (or subtitle) language fail to be selected:

- An alternative language is not selected with discs which do not contain more than one language.
- In the case of some discs, the alternative language cannot be selected by operating the AUDIO or SUBTITLE button.
Try selecting it from the DVD menu if one is available.

Angle cannot be changed:

- This function is dependent on software availability. Even if a disc has a number of angles recorded, these angles may be recorded for specific scenes only.

Instructions for the correct disposal of the product

INSTRUCTIONS AND INFORMATION REGARDING THE DISPOSAL OF USED PACKAGING MATERIALS

Dispose of packaging material at a public waste disposal site.

DISPOSAL OF USED ELECTRICAL AND ELECTRONIC APPLIANCES



The meaning of the symbol on the product, its accessory or packaging indicates that this product shall not be treated as household waste. Please, dispose of this product at your applicable collection point for the recycling of electrical & electronic equipment waste. Alternatively in some states of the European Union or other European states you may return your products to your local retailer when buying an equivalent new product. The correct disposal of this product will help save valuable natural resources and help in preventing the potential negative impact on the environment and human health, which could be caused as a result of improper liquidation of waste. Please ask your local authorities or the nearest waste collection centre for further details. The improper disposal of this type of waste may fall subject to national regulations for fines.

For business entities in the European Union

If you wish to dispose of an electrical or electronic device, request the necessary information from your seller or supplier.

Disposal in other countries outside the European Union

If you wish to dispose of this product, request the necessary information about the correct disposal method from local government departments or from your seller.



This product meets all the basic EU regulation requirements that relate to it.

Changes to the text, design and technical specifications may occur without prior notice and we reserve the right to make these changes.

The original version is in the Czech language.

Address of the manufacturer: FAST ČR, a.s., Černokostecká 1621, CZ-251 01 Říčany

SENCOR®

EN Warranty conditions

Warranty card is not a part of the device packaging.

This product is warranted for the period of 24 months from the date of purchase to the end-user. Warranty is limited to the following conditions. Warranty is referred only to the customer goods using for common domestic use. The claim for service can be applied either at dealer's shop where the product was bought, or at below mentioned authorized service shops. The end-user is obligated to set up a claim immediately when the defects appeared but only till the end of warranty period. The end user is obligated to cooperate to certify the claiming defects. Only completed and clean (according to hygienic standards) product will be accepted. In case of eligible warranty claim the warranty period will be prolonged by the period from the date of claim application till the date of taking over the product by end-user, or the date the end-user is obligated to take it over. To obtain the service under this warranty, end-user is obligated to certify his claim with duly completed following documents: receipt, certificate of warranty, certificate of installation.

This warranty is void especially if apply as follows:

- Defects which were put on sale.
- Wear-out or damage caused by common use.
- The product was damaged by unprofessional or wrong installation, used in contrary to the applicable instruction manual, used in contrary to legal enactment and common process of use or used for another purpose which has been designed for.
- The product was damaged by uncared-for or insufficient maintenance.
- The product was damaged by dirt, accident of force majeure (natural disaster, fire, and flood).
- Defects on functionality caused by low duality of signal, electromagnetic field interference etc.
- The product was mechanically damaged (e.g. broken button, fall).
- Damage caused by use of unsuitable media, fillings, expendable supplies (batteries) or by unsuitable working conditions (e.g. high temperatures, high humidity, quakes).
- Repair, modification or other failure action to the product by unauthorized person.
- End-user did not prove enough his right to claim (time and place of purchase).
- Data on presented documents differs from data on products.
- Cases when the claiming product cannot be indentified according to the presented documents (e.g. the serial number or the warranty seal has been damaged).

Authorized service centers

Visit www.sencor.eu for detailed information about authorized service centers.