

Robot Vacuum Cleaner User Manual

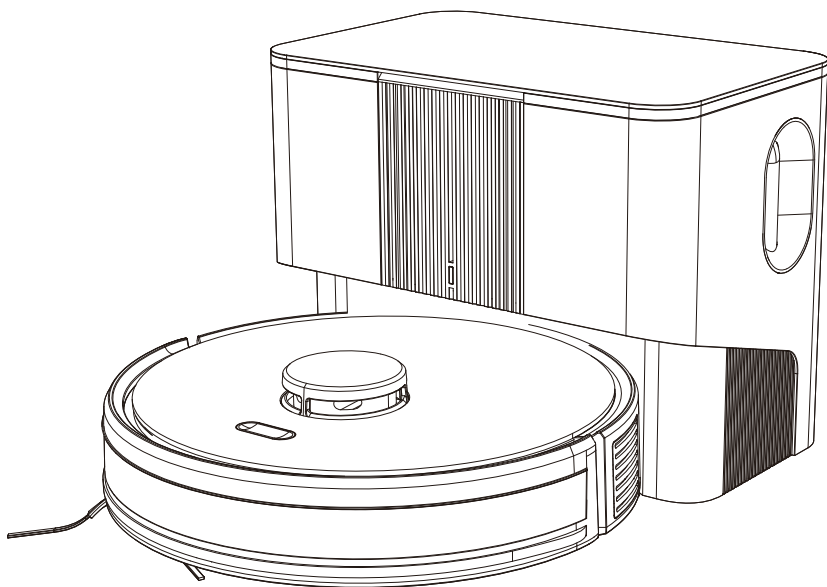

READ THESE INSTRUCTIONS CAREFULLY BEFORE
USING THE PRODUCT, AND KEEP IT PROPERLY.

Catalogue

1.	IMPORTANT SAFETY INSTRUCTIONS.....	02
	Packing List.....	05
2.	Parts Name.....	06
3.	Product Use.....	08
3.1	Attentions.....	08
3.2	Preparation	09
3.3	Robot Charge.....	09
3.4	Install Integrated Water Tank and Dust Box.....	10
3.5	Robot Operation.....	10
3.7	Collecting dust.....	11
4.	Connect to the APP	12
	APP Operation and Functions.....	12
5.	Regular Care & Maintenance.....	15
5.1	Cleaning & Maintaining Integrated Water Tank & Dust Box	15
5.2	Cleaning and Maintaining Big dust box	15
5.3	Cleaning & Maintaining Roller Brush , Side Brush , Driving Wheel and Universal Wheel	16
5.4	Cleaning & Maintaining Charging Contacts, Anti-drop Sensors and Bumper.....	17
5.5	Cleaning Self-empty Base.....	17
6.	Troubleshooting.....	18
7.	Fault Elimination.....	22
7.1	Robot	24
7.2	Self-empty Base	23
8.	Product Parameter	24
9.	Factory Default Reset	24
10.	Environmental Protection Instructions	24

1. IMPORTANT SAFETY INSTRUCTIONS

When using an electrical appliance, basic precautions should always be followed, including the following:

READ THESE INSTRUCTIONS

WARNING – To reduce the risk of fire, electric shock, or injury:

1. If you don't use it for one month, please turn off the power.
2. After the cleaning is finished, it should be connected with the charging base correctly.
3. In view of the problems that may appear in the cleaning process, ensure the following is done prior to cleaning: ①Remove the power cord and small objects on the ground to avoid the product being blocked or items damaged; ②Fold the carpet tassels under the carpet and keep the hanging curtains and tablecloths away from the ground; ③Remove low and light objects on the ground, such as slippers and small toys, to avoid pushing to the edge corner.
4. If there is a suspended environment such as stairs, please test the product first to see if it can detect the edge of the hanging area without falling. Protective fence shall be set at the edge of the suspended area to prevent the product from falling. Make sure that the protection does not cause tripping.
5. Use only as described in this manual. Use only manufacturer's recommended attachments.
6. Do not unplug by pulling on cord. To unplug, grasp the plug, not the cord.
7. Do not handle plug or appliance with wet hands.
8. If the power cord is damaged, in order to avoid danger, it must be replaced by the professional personnel of the manufacturer, its maintenance department or similar departments.
9. Before cleaning and maintaining the product, please turn off the power of the product and pull the plug out of the power socket.
10. Before discarding the product, please remove the product from the charging base, turn off the power switch and take out the battery.
11. Before disposing of the appliance, please take the battery out the local laws, Please follow the local laws to dispose of the old battery.
12. This appliance is not intended for use by persons (including children) with reduced physical, sensory or mental capabilities, or lack of experience and knowledge, unless they have been given supervision or instruction concerning use of the appliance by a person responsible for their safety.
13. Do not allow to be used as a toy. Close attention is necessary when used by or near children. Do not allow children to sit on the vacuum.
14. Use only in household environment. Do not use in outdoor, commercial and industrial areas.
15. Do not operate the vacuum in a room where an infant or child is sleeping.
16. Do not use with damaged cord or plug. If appliance is not working as it should, has been dropped, damaged, left outdoors, or dropped into water, return it to a service center.
17. Do not operate the vacuum in a room that has lit candles on furniture that the vacuum may accidentally hit or bump into.
18. This appliance contains batteries that are non-replaceable, This appliance contains batteries that are only replaceable by skilled persons.

- 19、 Prevent unintentional starting. Ensure the switch is in the off-position before picking up or carrying the appliance. Carrying the appliance with your finger on the switch or energizing appliance that have the switch on invites accidents.
- 20、 Recharge only with the charger specified by the manufacturer. A charger that is suitable for one type of battery pack may create a risk of fire when used with another battery pack.
- 21、 While the Robot is working, keep hair, clothes, fingers and other parts of the human body away from the opening and operating parts of the product.
- 22、 Do not use outdoors or on wet surfaces.
- 23、 Do not put any object into openings. Do not use with any opening blocked; keep free of dust, lint, hair, and anything that may reduce air flow..
- 24、 Do not use to pick up flammable or combustible liquids, such as gasoline, or use in areas where they may be present.
- 25、 Do not pick up anything that is burning or smoking, such as cigarettes, matches, or hot ashes. Do not use without dust bag and/or filters in place.
- 26、 It is forbidden to place objects in the roller brush mouth. Do not use the product when the roller brush mouth is blocked. Clean the dust, cotton wadding, hair, etc. at the roller brush mouth to ensure smooth air circulation.
- 27、 Use the power cord carefully to avoid damage. It is forbidden to use the power cord to drag or lift the product and its charging base, to use the power cord as a handle, to clamp the power cord in the crack of the door, and to pull the power cord at sharp corners. It is forbidden to run the product on the power cord, and the power cord should be away from the heat source.
- 28、 For use only with CH01 charger OR with C710 Self-empty Base
- 29、 It is forbidden to use the damaged charging base. If the charging base is damaged, in order to avoid danger, it must be repaired or replaced by the manufacturer, authorized dealer or professionals from similar departments.
- 30、 Under abusive conditions, liquid may be ejected from the battery; avoid contact. If contact accidentally occurs, flush with water. If liquid contacts eyes, additionally seek medical help. Liquid ejected from the battery may cause irritation or burns.
- 31、 Do not use a battery pack or appliance that is damaged or modified. Damaged or modified batteries may exhibit unpredictable behavior resulting in fire, explosion or risk of injury.
- 32、 Do not expose an appliance to fire or excessive temperature. Exposure to fire or temperature above 130°C may cause explosion.
- 33、 Follow all charging instructions and do not charge the battery pack or appliance outside of the temperature range specified in the instructions. Charging improperly or at temperatures outside of the specified range may damage the battery and increase the risk of fire.
- 34、 Do not use and store in extremely hot or cold environments. It is forbidden to use the product in extremely hot (above 40 °C) or extremely cold (below 0 °C) environment. Do not store below -20 °C or above 60 °C. Charge your robot in temperature between 0 °C and 40 °C.
- 35、 Do not use the mop holder module in a carpet environment.
- 36、 Do not use the LDS parts or bumper handling the robot
- 37、 It is forbidden to upgrade the software of the Robot under 50% battery capacity if not in charging.
- 38、 **Please don't put the self-empty base on the carpet.**

SAVE THESE INSTRUCTIONS

RF Exposure Warning

This equipment complies with FCC radiation exposure limits set forth for an uncontrolled environment.





This equipment must be installed and operated in accordance with provided instructions and the antenna(s) used for this transmitter must be installed to provide a separation distance of at least 20 cm from all persons and must not be collocated or operating in conjunction with any other antenna or transmitter.

Output power of the WI - Fi module is less than 20dBm

SAVE THESE INSTRUCTIONS

Environment friendly disposal	
	<p>This marking indicates that this product should not be disposed with other household wastes throughout the EU.</p> <p>To prevent possible harm to the environment or human health from uncontrolled waste disposal, recycle it responsibly to promote the sustainable reuse of material resources. To return your used device, please use the return and collection systems or contact the retailer where the product was purchased.</p> <p>They can take this product for environmental safe recycling.</p>

Symbol description

	Class II equipment		Direct current
	For indoor use only		Alternating current
	Read operator's manual		

Hereby, **XXX** declares that this Robot Vacuum Cleaner is in compliance with the essential requirements and other relevant provisions of Directive 2014/53/EU.

A copy of the Declaration of conformity can be **XXX**

Packing List

Will differ per different configurations

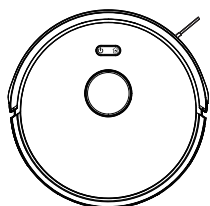

Robot Vacuum Cleaner

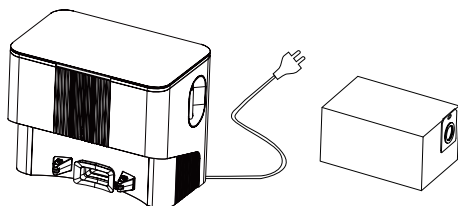

Self-empty Base+Dust bag

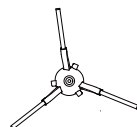

Side Brush

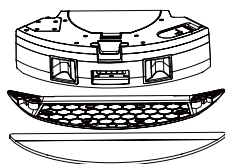

Integrated Water Tank
and Dust Box (with
washable mop and holder)

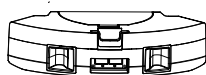

Big Dust Box

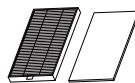

High Efficiency
Filter and Sponge



Roller Brush

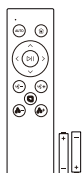

Remote Control
+ AAA Battery

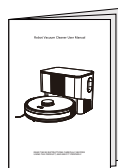

User Manual



Cleaning Tool
Brush

2. Parts Name

Main Unit

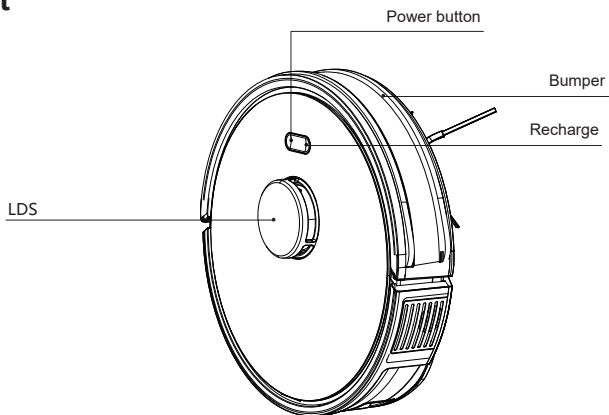

Rear View

Anti-drop Sensors

Universal Wheel

Charging Contacts

Anti-drop Sensors

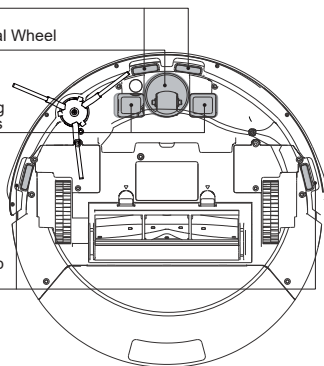

Side Brushes

Carpet Sensor

Roller Brush Release Button

Driving Wheel

Roller Brush (main brush)

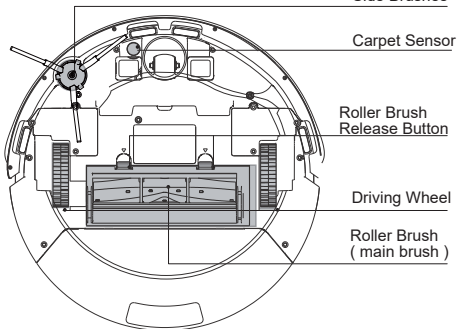

Integrated Water Tank and Dust Box

Charging Contacts

Water Inlet

Integrated Water Tank and Dust Box

Mop holder

Washable Mop cloth

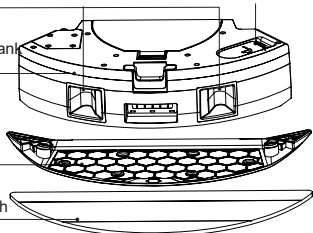

High Efficiency Filter

Sponge Filter

Primary Filter

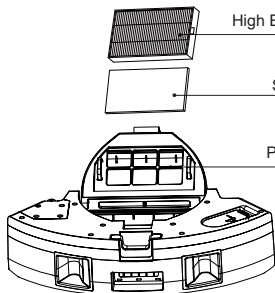

Big Dust Box

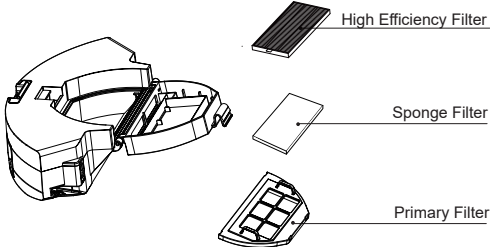

Self-empty Base

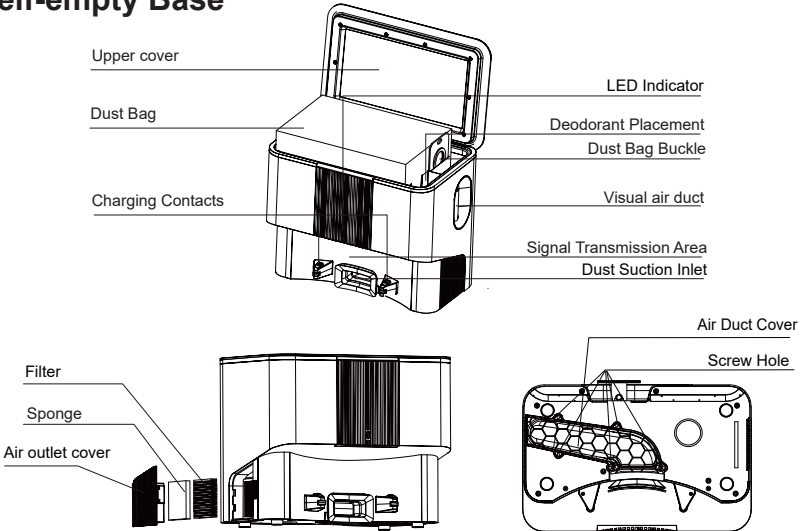

Remote Control

1. For Dust box

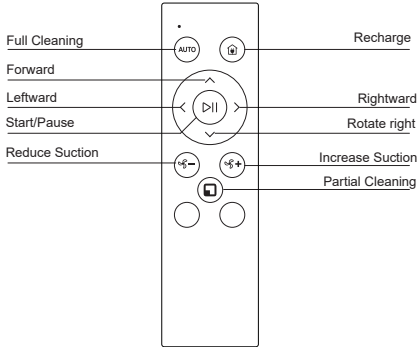

2. For Integrated water tank and dust box

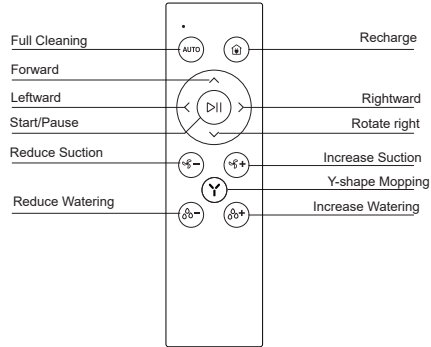

3. Product Use

3.1 Attentions

Check and arrange the area to be cleaned to keep safe. Put furnitures well and remove the obstacles.

Remove or cover the low objects on the ground that may affect the Robot working, such as the scale and the base of the floor fan.

If there are carpet tassels, please put it under the carpet in advance.

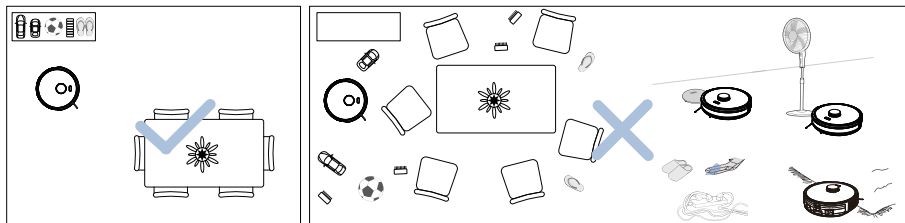

If the Robot is cleaning at the entrance of compound stairs and the edge of steps, please place protective fence to ensure its safety and smooth operation.

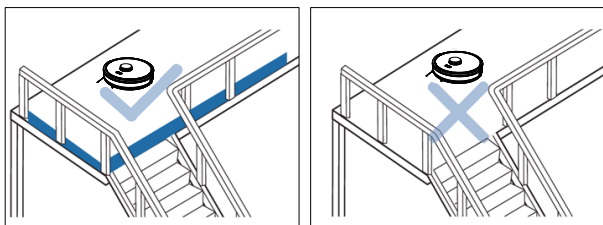

Remove all objects that may entangle the Robot, such as power cord, rope, etc. In addition, if the step is too high, it may get stuck.

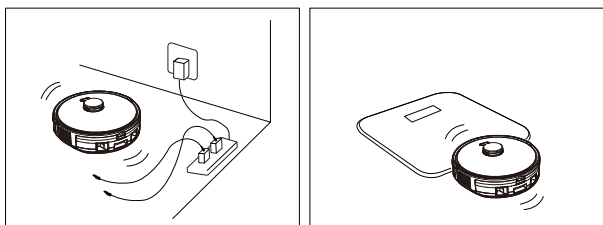

Warm tips:

For the first time use, please follow the Robot during whole cleaning process to help solve some small problems, so that it can clean smoothly. When follow the Robot, please be careful not to stand in front of it.

3.2 Preparation

Before using the product, please remove the protective strip and protective film.

Remove the protective strip

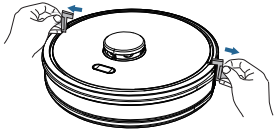

Install side brushes and lock screw

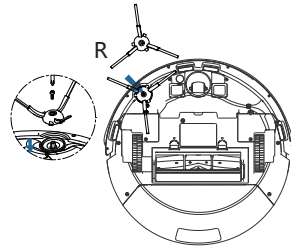

3.3 Robot Charging

1. Put the self-empty base in ground against the wall. There should be no cliffs/stairs or objects in the area 1m to the left and right and 2m in front; connect to supply power.

*keep objects with strong reflecting surface such as mirror or glass away

*Keep self-empty base away from direct sunlight.

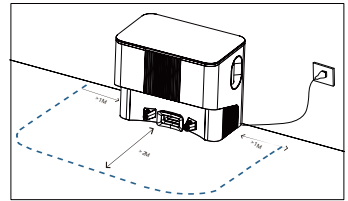

2. Long press the power button for 3S to turn on the Robot and put it into self-empty base, and connect the charging contacts of them.

Tips:

1. Robot cannot be charged when it's power off.

2. Please put the excess wire into storage slot, power cable can be pulled out at both sides.

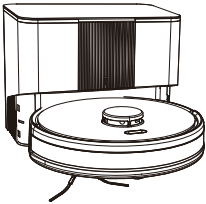
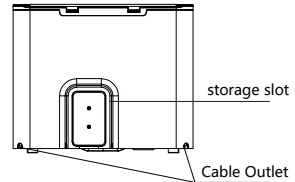

3. For first time use, please fully charge it. During the charging, the recharge button is breathing light in white; The light will be white flash when charging finishes and the robot will be in standby status after 10S Charging time is about 4-5 hours.

Warm Reminder:

1. During daily use, please put the Robot into the self-empty base. Also ensure self-empty base is connected to the power supply and the Robot power is on.

2. During daily use, pay attention to clean the charging contacts for better charging.

3. If you do not use the Robot for a long time, please fully charge it before turn it off, then store it in a ventilated and dry place. And it is necessary to charge it once a month to protect battery.

4. If the battery is over discharged or not used for a long time, Robot may not be rechargeable. Please contact our after-sales service for maintenance. Do not disassemble it by yourself

CAUTION: In order to avoid a hazard due to inadvertent resetting of the thermal cut-out, this appliance must not be supplied through an external switching device, such as a timer, or connected to a circuit that is regularly switched on and off by the utility.

3.4 Install Integrated Water Tank and Dust Box

1. open the cover and fill with the water tank with water.

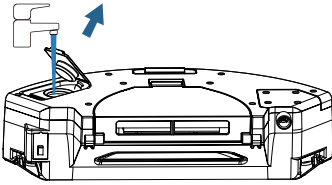

2. Close the lid of water inlet cover. (Make sure the lid close well and no raised parts.)

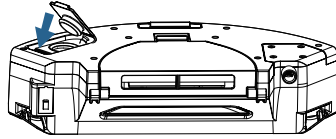

3. Install the mop holder and mop cloth.

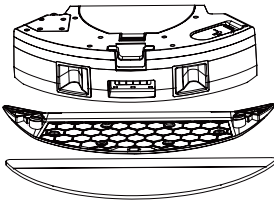

4. Press & hold the release key and insert the integrated water tank & dust box.

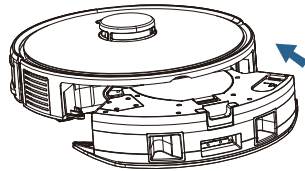

Warm Tips:

1. In order to prolong the service life of the water tank, it is recommended to use purified water or soft water.
2. Do not use the mopping function on the carpet.
3. After mopping, please empty the water tank in time and remove the mop holder.
4. After the mop holder is installed, the Robot will work as sweeping & mopping together. Suction power defaulted to mute level and can't be adjusted manually.
5. When mop holder is not installed, Robot will work as sweeping modes, vacuum and sweep without mopping.
6. It is normal that a little water remains in the water tank due to factory inspection.

3.5 Robot Operation

1.start

Press the power button of Robot or start button of remote control, Robot will build a map based on its scan of the room, then splits each room into squares, cleaning the edges of the square first before covering the inside in a zigzag pattern, finally complete cleaning of all areas.

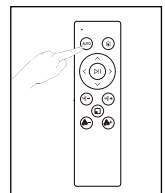
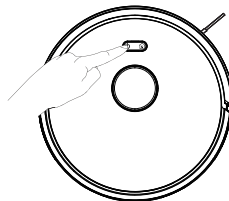

2.pause

When Robot is working, press the power button of Robot or pause button of remote control to pause the robot.

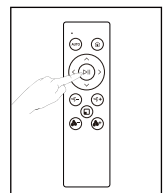
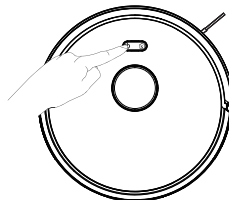

3. Partial Clean

Press partial cleaning button of remote control, Robot will clean a 1.5m*1.5m square area centered on itself.

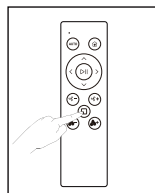

4. Recharge

Press recharging button of Robot or remote control, Robot will return to Self-empty Base.

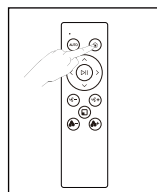
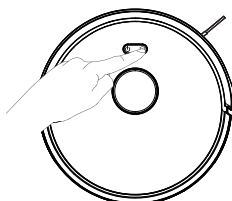

5. Sleep and wake up

Robot will sleep after full charged or without operated for 10 minutes.

When Robot is not in self-empty base and sleep for more than 4 hours, it will automatically shutdown.

When Robot sleep, press the button of remote control, Robot or App to wake it up.

6. Turn off

Long press power button of the robot for 5S. The light will be off and robot is power off.

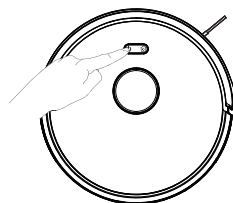

3.7 Collecting dust

1. Robot will automatically return to self-empty base for charging and collecting dust after finishing cleaning.
2. Press Recharge button and Robot will return to self-empty base for charging and collecting dust.
3. During dust collection, press any button to stop.

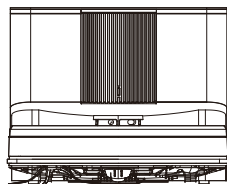
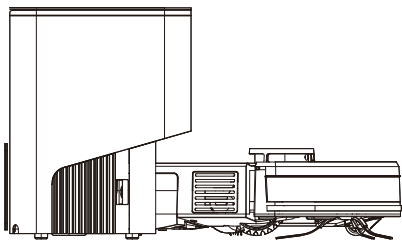

4. Connect to the APP

1.APP download

Scan QR code on the right and download and install APP according to the indications.

2.Add device

Open the APP to 'My Device' page, press upper right corner '+' and follow APP indication to add device.

Warm Reminder :

1. APP has requirements for mobile system version: IOS 9.0 & above, Android 5.0 & above. Please update the mobile system version before using APP.
2. Before WIFI connection, please make sure that the mobile phone and home network are connected.
3. For the house without WIFI network, please use your Mobile Network with Personal Hotspot to connect Robot.

APP Operation and Functions

➤ Map management

Before use, it is recommended to switch on Map Save Mode to get advanced experience.

1.Map building: Selecting Full Cleaning mode, Robot starts cleaning from self-empty base, and returns to self-empty base after finished. It will build a map of partitions according to the layout of your house. You can save the map in APP. It is up to save 4 maps.

2.Map editing: You can split, merge or rename partitions of the map.

➤ Full Cleaning

Robot will build a map based on its scan of the room, then splits each room into squares, cleaning the edges of the square first before covering the inside in a zigzag pattern, finally complete cleaning of all areas.

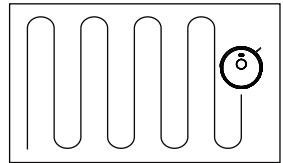

➤ Room Cleaning

Robot will clean the Rooms selected in App.

Tips:

- 1.It's necessary to switch on Map Save Mode in APP and save a map before Room Cleaning.
- 2.Room Cleaning can only be used to customize the cleaning area and not to isolate hazards. Please clear obstacles around the selected rooms.

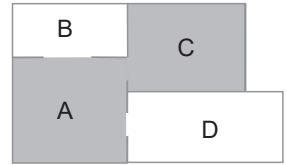

➤ Zone Cleaning

Robot will clean the Zones drawn in App.

Tips:

- Zone cleaning can only be used to customize the cleaning area and not to isolate hazards. Please clear obstacles around the drawn zones.

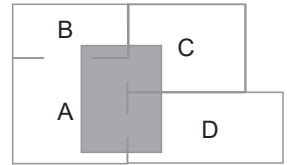

➤ Pin n go

Specify a point on the map, and Robot will get there automatically.

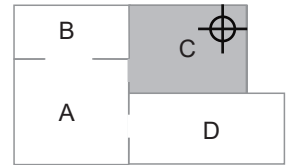

➤ Breakpoint resume

When the battery is low during the cleaning, Robot will automatically return to Self-empty Base for charging; After charging to 80%, it will continue cleaning from where it left off.

Tips:

1. The robot will not resume cleaning in Do Not Disturb mode;
2. Recharging manually or moving Robot, it will not resume cleaning.

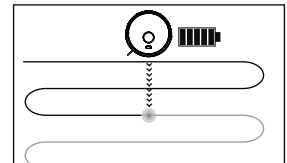

➤ Y-shape mopping

When mop holder installed, press Y-shaped cleaning button in App, and Robot will mop the floor in a Y-shape by simulating artificial work.

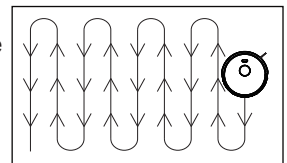

➤ **Restricted Area**

No-Go Zones, No-Mop Zones and virtual Wall are to prevent robot from access certain areas and rooms. By default, No-Mop Zones will be activate only when Mop holder is in place.

Tips:

- 1.Restricted areas can be created on a saved or build-ing map.
- 2.Restricted Areas can only be used to customize cleaning area and not to isolate hazards.
- 3.Moving the robot from obvious changes of house environment may cause the map to become invalid, and the restricted area may be lost.

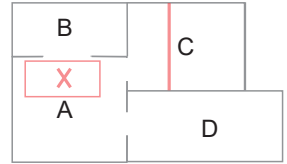

➤ **Scheduled cleaning.**

Set cleaning schedules in App. Robot will clean at defined times and return to self-empty Base when finished.

Tips:

Robot will not clean as scheduled when in low battery.

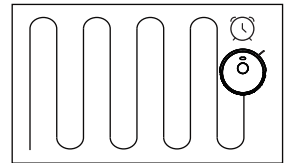

➤ **More Functions.**

Real-Time Map View	Carpet Mode	Positioning Robot	Remaining Power
Cleaning mode settings	Cleaning History	Firmware Updates	Voice settings
Maintenance Schedule	Remote Mode	Do Not Disturb (DND) mode

5. Regular Care & Maintenance

5.1 Cleaning & Maintaining Integrated Water Tank & Dust Box

1. Press & hold the release key and pull the integrated water tank & dust box.

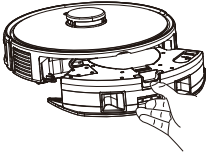

2. Take out the mop holder and mop cloths.

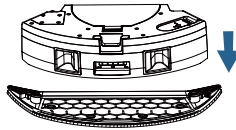

3. Wash and dry the mop cloths.

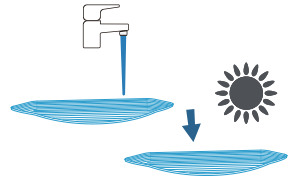

4. Open the dust box and take out the primary filter, High efficiency filter and filter sponge.

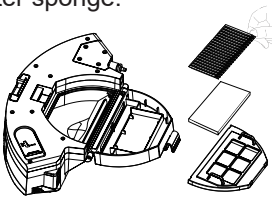

5. Clean the dust on the primary filter with cleaning tool brush. Tap the High efficiency filter to remove dust.

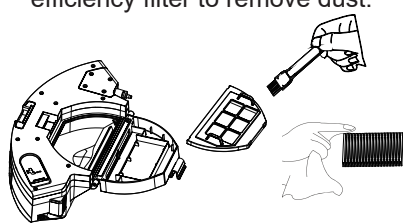

6. Wash the dust box and filter sponge with water. **High efficiency filter can't be washed.** If it is accidentally soaked in water, please air-dry before use.

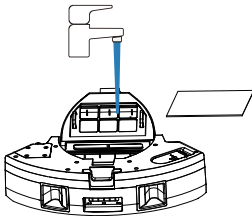

7. Empty the remaining water from the water tank. Air-dry the water tank, dust box and filter sponge in shade.

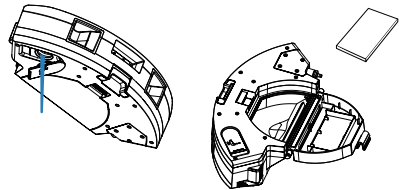

5.2. Cleaning and Maintaining Big dust box

1. Press & hold the release key to pull the big dust box.

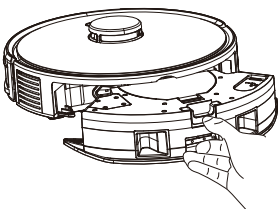

2. Open the dust box lock, take out the primary filter, High efficiency filter and filter sponge.

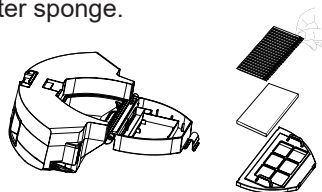

3. Clean the dust on the primary filter with cleaning tool brush. Tap the High efficiency filter to remove dust.

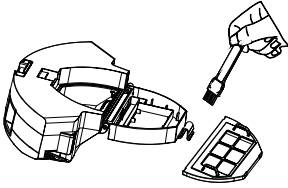

4. Wash the dust box and filter sponge with water. **High efficiency filter can't be washed.** If it is accidentally soaked in water, please air-dry before use.

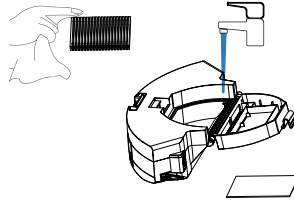

5. Air-dry the dust box and filter sponge in shade.

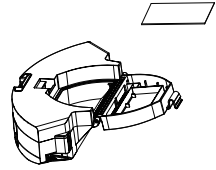

5.3 Cleaning & Maintaining Roller Brush , Side Brush, Driving Wheel and Universal Wheel

■Cleaning Roller Brush and Side Brush

1. Pull on the release tabs to unlock the brush guard as shown.

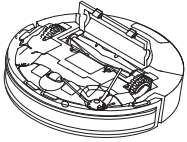

2. Lift the roller brush to remove it.

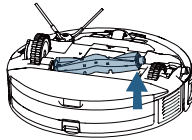

3. Clean the roller brush with the cleaning tool brush.

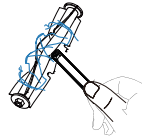

4. Clean the side brush with the cleaning tool brush.

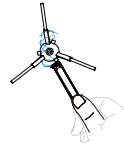

■Clean the driving wheel

1. Use the cleaning tool brush to remove the hair and garbage on the driving wheel.

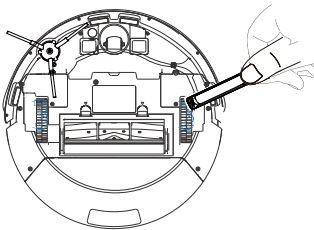

2. When the driving wheel is stuck, flip its gear in the opposite direction, trash will fall from the gap.

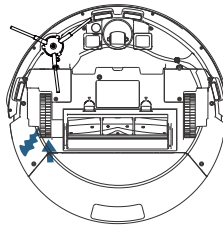

■Clean the universal wheel

Use the cleaning tool brush to clean the hair and garbage on the universal wheel.

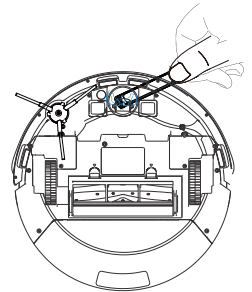

5.4 Cleaning & Maintaining Charging Contacts, Anti-drop Sensors .

Clean the Charging contacts of Self-empty Base.

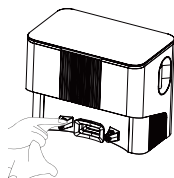

Clean the Robot Charging contacts

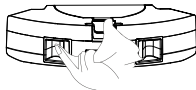

Clean the Anti-drop Sensors

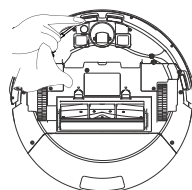

Warm tips:

Charging contacts, Anti-drop sensors all contain sensitive electronic components. Please use a dry rag when cleaning them, not a wet rag to prevent water damage.

5.5 Cleaning Self-empty Base

To ensure the dust collection effect, it is recommended to replace the dust bag in time and clean the filter and air duct regularly.

■ Replace the dust bag and clean the filter

1. Open the upper cover of Base.

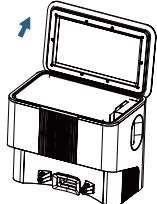

2. Take out the full dust bag.

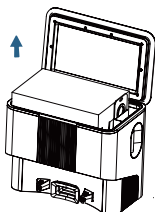

3. Take out the filter screen and clean it.



4. Install filter and new dust bag

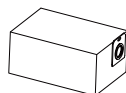

■ Clean air duct

Unscrew the air duct lower housing screws

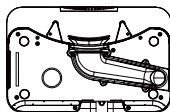

Remove the air duct shell and clean the air duct



6. Troubleshooting

During the use of the product, in case of the following conditions. It can be checked and solved independently by users.

No	Fault condition	Likely cause	What to do
01	Robot can't connect to APP	The router user name and password are incorrect	Configure the router network and make sure that the "user name" and "password" of the router are correct
		The robot is not within the network signal coverage of the router	Ensure that the robot is within the network signal coverage of the router
		Is the robot in the state to connect WIFI?	Only when the robot is in the state to connect WIFI, it can connect properly. When the robot is power on, press RECHARGE & PARTIAL Cleaning 5S until hearing 'Resetting WIFI'. WIFI LED flashes blue, indicating that the robot is in the state to connect WIFI.
		Not using 2.4G network	The robot does not support 5G network at present. Please choose 2.4G
		APP doesn't support the current router model device	Please check the specific supported models according to the APP prompts
02	Unable to install app	The version of mobile operating system is too low	For mobile phones with IOS 9.0 or above and Android 5.0 or above, you can download and use the APP.
03	The robot cannot be turned on	Low power. Temperature is not suitable.	Please charging the robot. Please use the robot in an environment of 0-40°C.
04	The robot can't charge	Self-empty base not connected to power supply	Make sure the power supply and the self-empty base is connected and base indicator lights up
		The charging contacts of the robot and the self-empty base is not fully connected or the charging contacts are dirty.	Ensure that the charging contacts of the robot and self-empty base is fully connected, and the recharge button is white breathing . Check whether the charging contacts of the robot and self-empty base are dirty, and refer to the part of [regular maintenance] in the manual for cleaning.
		Temperature is not suitable	Please charge the robot in an environment of 0-40°C
		If the battery is not used for a long time, it will lead to over discharge	It is recommended to use this product frequently. If it is not used for a long time and cannot be charged, please contact the aftersales service personnel
05	Water tank is leaking	The water tank is not closed completely	Make sure the lid of water inlet close well

No	Fault condition	Likely cause	What to do
06	Robot is not working	Low power The side brush & roller brush are entangled, and the dust box and filter material are blocked	Charging the robot Check whether the robot has abnormal alarm. It is recommended to clean and maintain the side brush, roller brush, dust box and filter material regularly
07	Robot walking back	There are obstacles ahead Bumper plate stuck The surface area of anti-drop sensor lens has dust	Clear the obstacles ahead Tap the bumper plate to check whether there is something stuck Clean the surface area of anti-drop sensor lens
08	Water tank or dust box falling off	The installation is not in place	When installing, please push hard and hear a "click" to ensure that it is installed in place
09	The water tank with no water or little water seepage after installation	No water in the water tank. Outlet of water tank is blocked. Mop holder is not installed.	Add water to the water tank. Clear up the outlet of water tank. Make sure the mop holder is installed.
10	Unable to return to the self-empty base automatically	The self-empty base is powered off or moved manually.	Please check whether the self-empty base is connected to the power. Do not move the self-empty base manually.
		The recharge route is blocked or too many obstacles are near the self-empty base	Please place the self-empty base in an open area and keep the recharge route smooth.
		It will regenerate the map in partial cleaning and may be unable to automatically recharge if the self-empty base is far away	Please manually put the robot into the self-empty base to charge
11	If the cleaning is not finished, the robot returns to charge	The robot feels that the power is low	The robot will automatically return to charging, and then performs a break-point resume
		Complex furniture environment will reduce cleaning efficiency, so it may not finish cleaning.	Arrange the furniture environment to make it easy to clean.
12	Abnormal noise during cleaning	The roller brush, side brush or driving wheel may be entangled, and the universal wheel may be entangled during the cleaning	Please clean it after power off. It is recommended to take them out and clean. Refer to regular maintenance
13	Noisy operation	The dust baffle at the air inlet of the dust box is stuck The suction is at high level	Take out the dust box and adjust the dust baffle to ensure its flexible movement. It is suggested that users can choose lower or mute suction power for cleaning when they are at home and use high-grade suction power when they go out

No	Fault condition	Likely cause	What to do
14	The robot is in trouble when working	The robot is entangled or obstructed by scattered wires, drooping curtain cloth or carpet tassels on the ground	The robot will try all kinds of ways to get rid of the trouble, if not, it is recommended to help it manually
		The main engine may be jammed by furniture of similar height to the robot	The robot will try all kinds of ways to get rid of the trouble, if not, it is recommended to help it manually
15	Driving wheel alarms	The driving wheel is entangled with something and stuck	Turn off the robot and put the bottom up; first turn the wheel counterclockwise and then clockwise to turn out the debris and garbage stuck in it; then press and slide the driving wheels on both sides at the same time to check whether it can rotate and whether it can rebound after releasing
16	The cleaning ability is reduced or the ash dropped	The filter net is blocked The roller brush is entangled	Clean the filter net Clean the roller brush
17	When the robot is working, there are some problems, such as route disorder, deviation, repeated cleaning and small area not cleaned	The wires, slippers and other objects placed on the ground affect the normal work of the Robot	Before the robot works, please tidy up the scattered wires, slippers and other objects on the ground, and reduce the scattered objects on the ground as much as possible. If there is uncleaned area, the robot will clean the area independently. Please do not interfere (such as moving the robot or blocking its route)
		When the robot climbs the steps, threshold and door strip, the driving wheel slipped with the ground, which will affect the judgment on the environment of the whole house	It is recommended to close the door of the area and clean the area separately. After cleaning, it will return to the starting point. Please rest assured to use it
		Working on a newly waxed, polished floor or smooth tile reduces the friction between the driving wheel and the ground	It is recommended that you wait for the floor wax to dry before using
		Due to the different house environment, the robot can not enter some areas	It is suggested to tidy up the home environment to ensure that the Robot can enter for cleaning
18	Not cleaning as scheduled	Scheduled appointment cancelled Low power	Reset appointment Charge the robot
19	LDS Laser sensor abnormal	The laser sensor is blocked or stuck by something	Please turn off and clean it.

No	Fault condition	Likely cause	What to do
20	Not breakpoint resume cleaning	The robot is in Do Not Disturb mode	It will not follow scheduled cleaning in Do Not Disturb mode, you can adjust the Do Not Disturb mode time in the APP or clean at other times
		The robot didn't automatically return to the self-empty base last time.	Recharging or putting the robot to self-empty base manually, the robot will not follow breakpoint resume cleaning.
21	Self-empty base abnormal dust collection	The Base upper cover is not closed, and the filter of the base, the air inlet of the base or the air outlet of the Robot dust box are blocked.	Please the self-empty base and Robot dust box.
		Dust bag is uninstalled.	Please install a dust bag.
		Abnormal air pressure threshold of dust bag.	Please replace a dust bag.
22	Fan abnormal	Fan is entangled or blocked by something.	Please turn off the Robot and send it to the after-sales service point for professional maintenance.

If troubles can't be solved by above guides, please contact the after-sales person.

7. Fault Elimination

7.1 Robot

Robot Status	Light Indication	APP Indication	Voice Alarm
Fall (Anti-drop sensor alarm)	RED Light flash	Cliff Sensor Error, please clean the cliff sensor and start the robot away from the cliff	Error 1, Anti-drop sensors error, pls put the robot on the ground to start it
LDS abnormal	RED Light flash	LDS Error, please check LDS and move robot to new location and start	Error 2, please make sure the LDS LiDAR head is not blocked or stuck
Wheel electricity abnormal	RED Light flash	Wheel Error, please turn the wheels and clear by hand	Error 3, please check whether the driving wheel is stuck
Wheel speed abnormal	RED Light breath	Wheel decoder Error, please turn the wheels and clear by hand	Error 4, please check whether the driving wheel is normal
Main bumper abnormal	RED Light flash	Bumper Error, please clean the bumper and tap it	Error 5, please check and tap the robot main bumper
LDS LiDAR bumper abnormal	RED Light flash	LDS Bumper Error, please move robot and tap the LDS bumper	Error 6, please check whether the laser bumper is stuck
Fall (Wheel abnormal)	RED Light flash	Wheel Suspended, please put the robot on the ground and start	Error 7, wheel suspended, please put the robot on the ground to start it
Robot stuck	RED Light flash	Robot Stuck, please help Robot to get out of trouble	Error 8, please help the robot to get out of trouble
Side brush abnormal	RED Light flash	Side brush Error, please check side brush and clean up	Error 9, please check the side brush whether it is entangled
Roller brush abnormal	RED Light flash	Roll brush Error, please check roll brush and clean up	Error 10, please check the roller brush whether it is entangled
Anti-drop sensor abnormal	RED Light flash	Cliff Sensor Error, please clean the cliff sensor and start the robot away from the cliff	Error 12, please clean the anti-drop sensors, and start the robot away from the cliff
Robot leans	RED Light flash	Robot tilt, please put robot on the ground and start	Error 14, please put the robot on a level ground to start
Start on the carpet with mop holder	RED Light flash	Mopping Error, please put the robot away from carpet and start	Error 17, please move the robot away from the carpet to start
Start at forbidden area and alarm	RED Light flash	Forbidden Zone Error, please put robot away from the forbidden area and start	Error 18, Forbidden area or virtual wall detected, please move the robot away and restart
Low battery alarm	RED Light flash	Low Battery, please recharge	Error 19, Low battery, please recharge and start
Partial cleaning Error	RED Light flash	Partial cleaning Error, please put the robot in the area to be cleaned and then start partial cleaning	Error 22, please put the robot in the area to be cleaned and then start partial cleaning

Robot Status	Light Indication	APP Indication	Voice Alarm
The robot is trapped	RED Light flash	The robot is trapped, please remove obstacles around the robot or move robot to a new location to start	Error 23, please remove obstacles around the robot or move robot to a new location to start
No Dust Box	RED Light flash	Dust box detection Error, please install the dust box and start	Error 24, Please install the dust box in time and start
Collect Press Error		Air Pressure Abnormal, please close the self Empty base, or check if filter, air inlet & dust box are blocked	Error 26, Please close the Self Empty base, or check if filter, air inlet & dust box are blocked
Collect Dust Error		Dust Bag Abnormal, please check if the dust bag is installed	Error 27, Please check if the dust bag is installed
Dust Full Abnormal		Dust Full Abnormal, please replace the dust bag immediately	Please replace the dust bag immediately

7.2 Self-emptying base Light Indication

Scene	White light	Red light
Not charging (Robot not stand in Self Emptying base)	On	Off
Not charging (Robot stands in Self Emptying base with full power, and it enters sleep mode)	On	Off
Charging	Breathing	Off
Collecting dust	On	Off
Air pressure inspection abnormal (Self Emptying base not closed /Self Emptying base Filter blocked / Self Emptying base Air inlet blocked / Dust outlet of Robot dust box blocked)	Off	On
Collecting dust without a Dust bag	Off	Flashing
Collecting dust with a full dust bag	Off	Flashing

8. Product Parameter

Robot Vacuum Cleaner	
Model No	A9 ECO
Robot Size	33*32.5*10CM
Robot Rated Input	19V $\overline{=}$ 0.6A 11.4W
Battery	14.4V/2600mAh Li-ion battery
Charging Time	4-5 Hours
Net Weight	2.65KGS
Self-empty Base	
Size	32*21*26CM
Dust Bag	5L
Power	850W
Output	19V $\overline{=}$ 0.6A
Net Weight	3.65KG
LiDAR	DC 5V, 240mA, Wavelength 775nm-800nm, Laser Class 1

This equipment should be operated with a minimum distance of 20cm between the radiator and your body.

9. Factory Default Reset

Long press both power button and recharge button for 10 seconds until hearing "Start factory default reset" and power on music, Robot will automatically restart, and related settings such as regular cleaning, map and WIFI will be restored to the default.

10. Environmental Protection Instructions

Due to chemical substances contained in the built-in lithium-ion battery of the robot may pollute the environment, please take out the battery before discarding product, and discard the lithium-ion battery in accordance with relevant local laws and regulations.

Warm Tips:

- * Please make sure to remove the battery when the power switch is turned off.
- * Please disassemble the entire battery pack together, do not damage the battery pack shell, so as to avoid short circuit or material leakage. If accidentally contact with battery exudate, please rinse with plenty of water and seek medical advice in time.