

# playmobil®

6678



## WARNING: CHOKING HAZARD

Small parts. Not for children under 3 years.

"Ne concerne que les USA"



Wichtige Unterlagen, bitte sorgfältig aufbewahren!  
Important: Please keep these instructions for future reference!  
Documents importants, à conserver soigneusement!  
Belangrijke documenten, bewaar deze zorgvuldig!

Serviceadressen finden Sie in allen Playmobil-Prospekten

Addresses of Customer Service Departments are shown in all Playmobil catalogues

L'adresse du service consommateurs est indiquée dans tous les catalogues Playmobil

Troverete gli indirizzi dei centri di assistenza in tutti i cataloghi Playmobil

In alle PLAYMOBIL catalogi vindt u het adres van onze klantendienst.

Las Direcciones de los Departamentos de Servicio al Consumidor se encuentran en todos los catálogos Playmobil

Η διεύθυνση του Γραφείου Εξυπηρέτησης Καταναλωτών PLAYMOBIL βρίσκεται σε όλους τους καταλόγους PLAYMOBIL.

pronounce: plāy-mō-bēēl



1

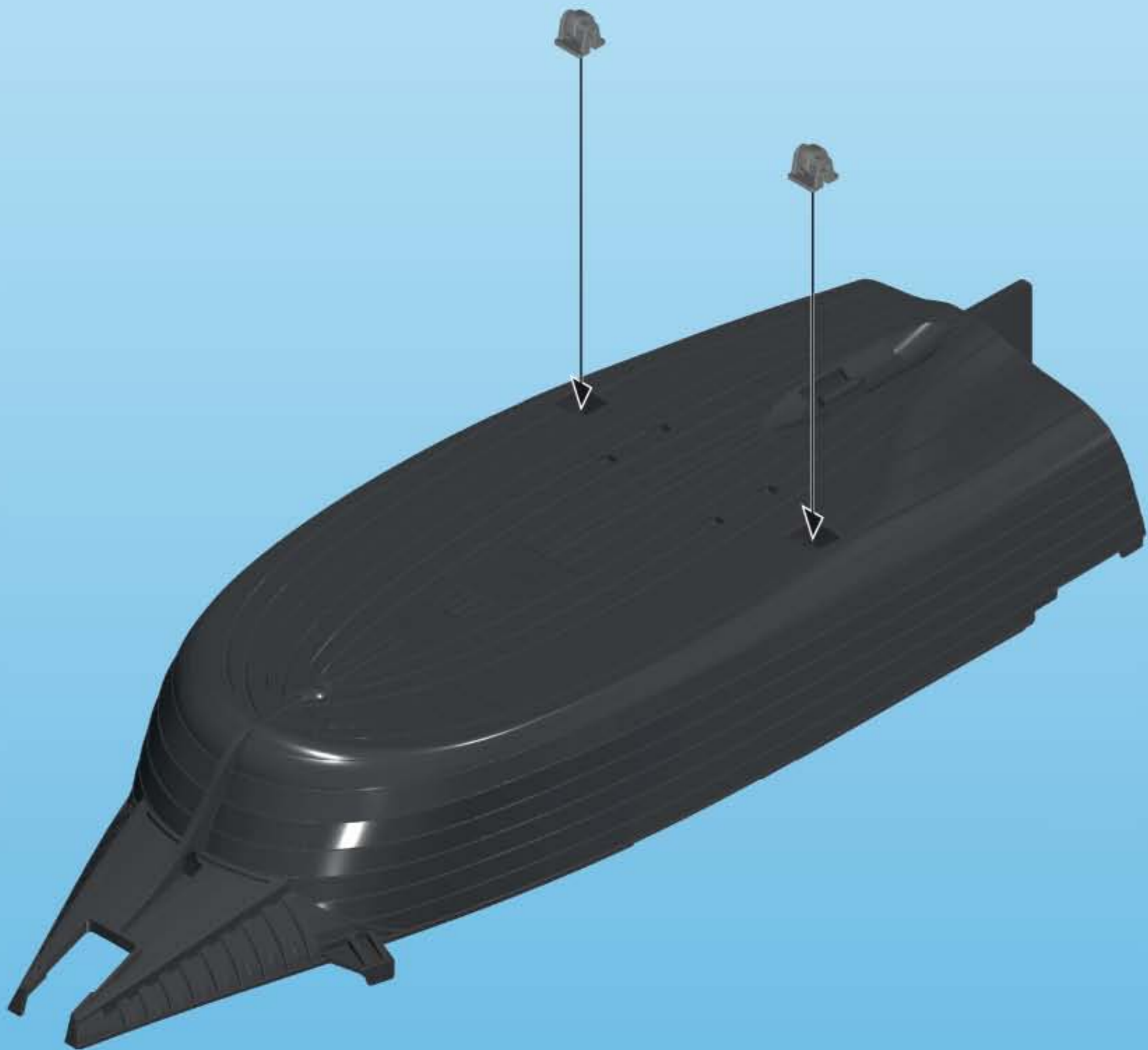

2

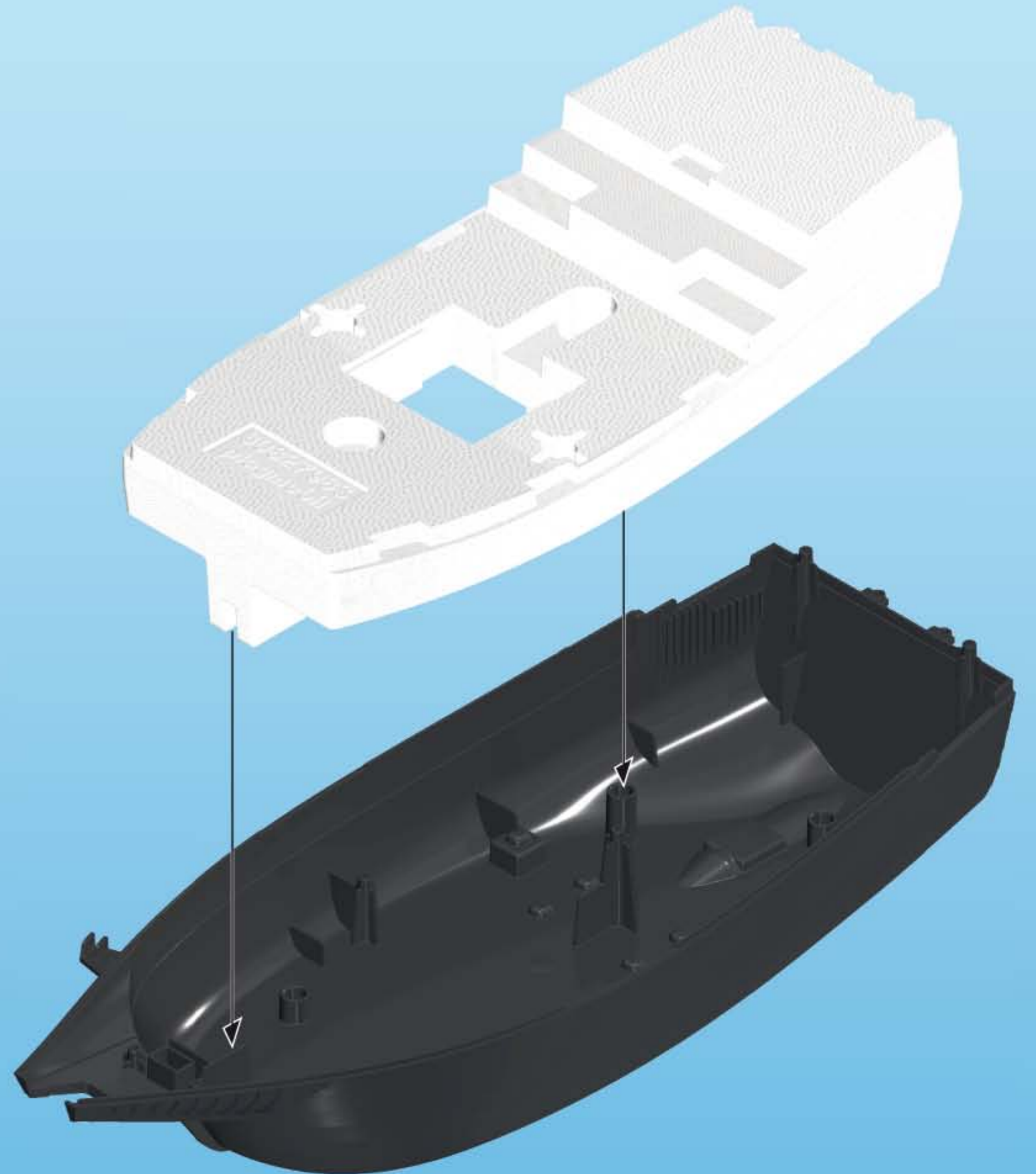



3

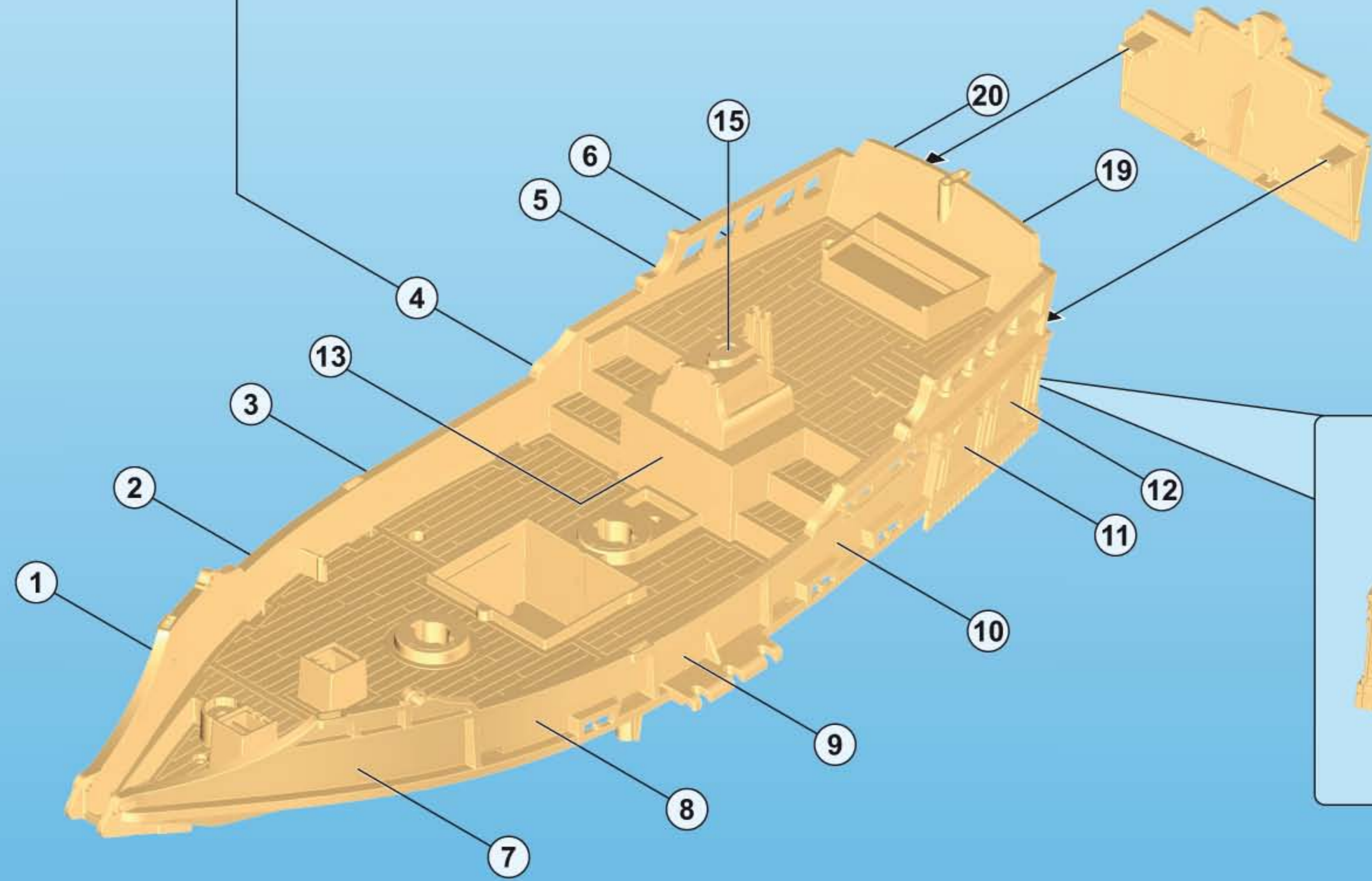
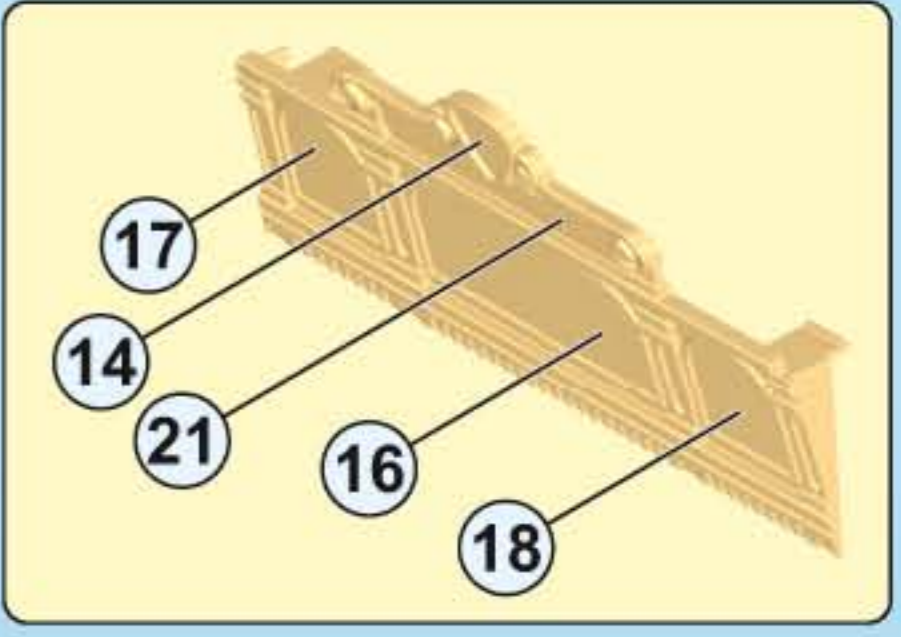
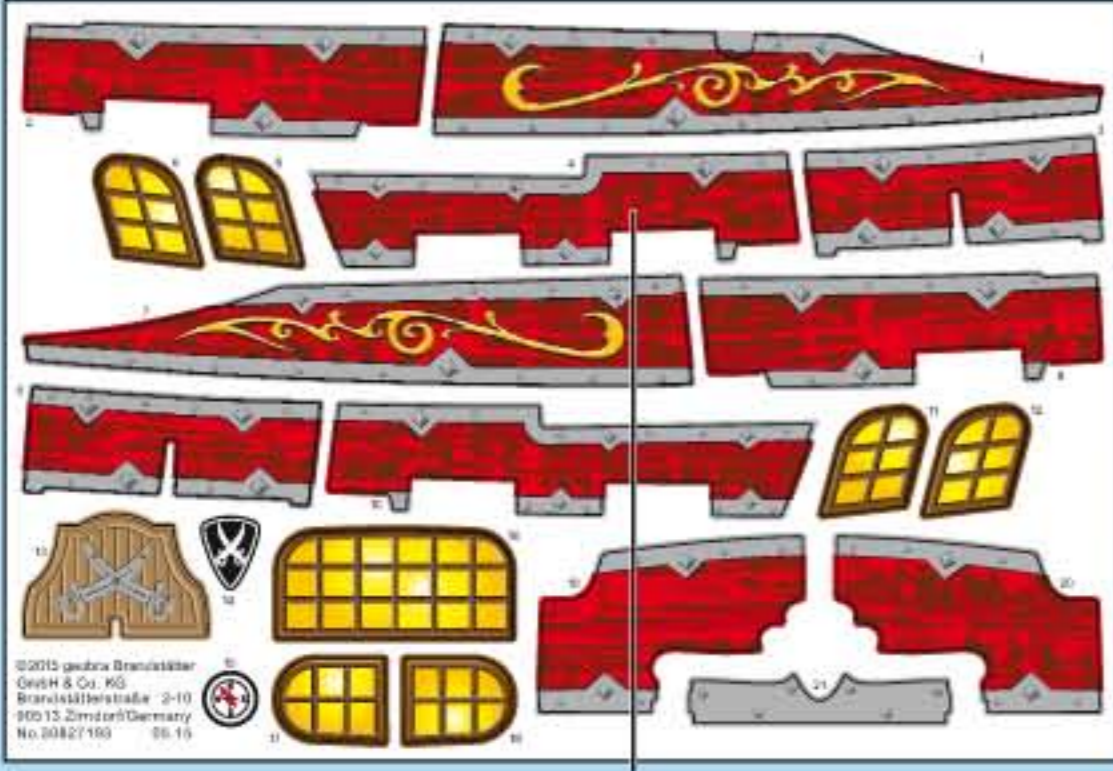



**D A CH L B** Montage nur durch Erwachsene!

**USA GB CDN M IRL** Adult assembly only!

**F CDN B L CH** Le montage doit être réalisé par un adulte

**E MEX** ¡Solo se debe montar por adultos!

**NL B** Opbouw enkel door volwassenen!

**I CH** Assemblabile solo da adulti

**P** Só deve-se montar por adultos!

**DK** Skal monteres af en voksen!

**N** Må monteres av en voksen!

**S FIN** Får endast monteras av vuxen!

**FIN** Aikuisen on koottava tuote.

**H** Szűlői felügyelet szükséges!

**CZ** Montovat smí jenom dospělí!

**EST** Monteerida tohivad ainult täiskasvanud!

**LV** Montāžu drīkst veikt tikai pieaugušie!

**LT** Montavimą gali atlikti tik suaugusieji!

**SLO** Izdelek lahko sestavijo le odrasle osebe!

**SK** Montáž len prostredníctvom dospelých osôb!

**PL** Montaż tylko przez osoby dorosłe!

**TR CY** Montaj yalnızca yetişkinler tarafından yapılmalıdır!

**GR CY** Η συναρμολόγηση πρέπει να γίνει οπωσδήποτε από κάποιον ενήλικο!

**RO** Montarea se efectuează doar de către adulți!

**BG** Монтажът следва да се извършва само от възрастни!

**HR** Montažu smiju izvoditi samo odrasli!

**CN** 只能由成年人组装!

7x

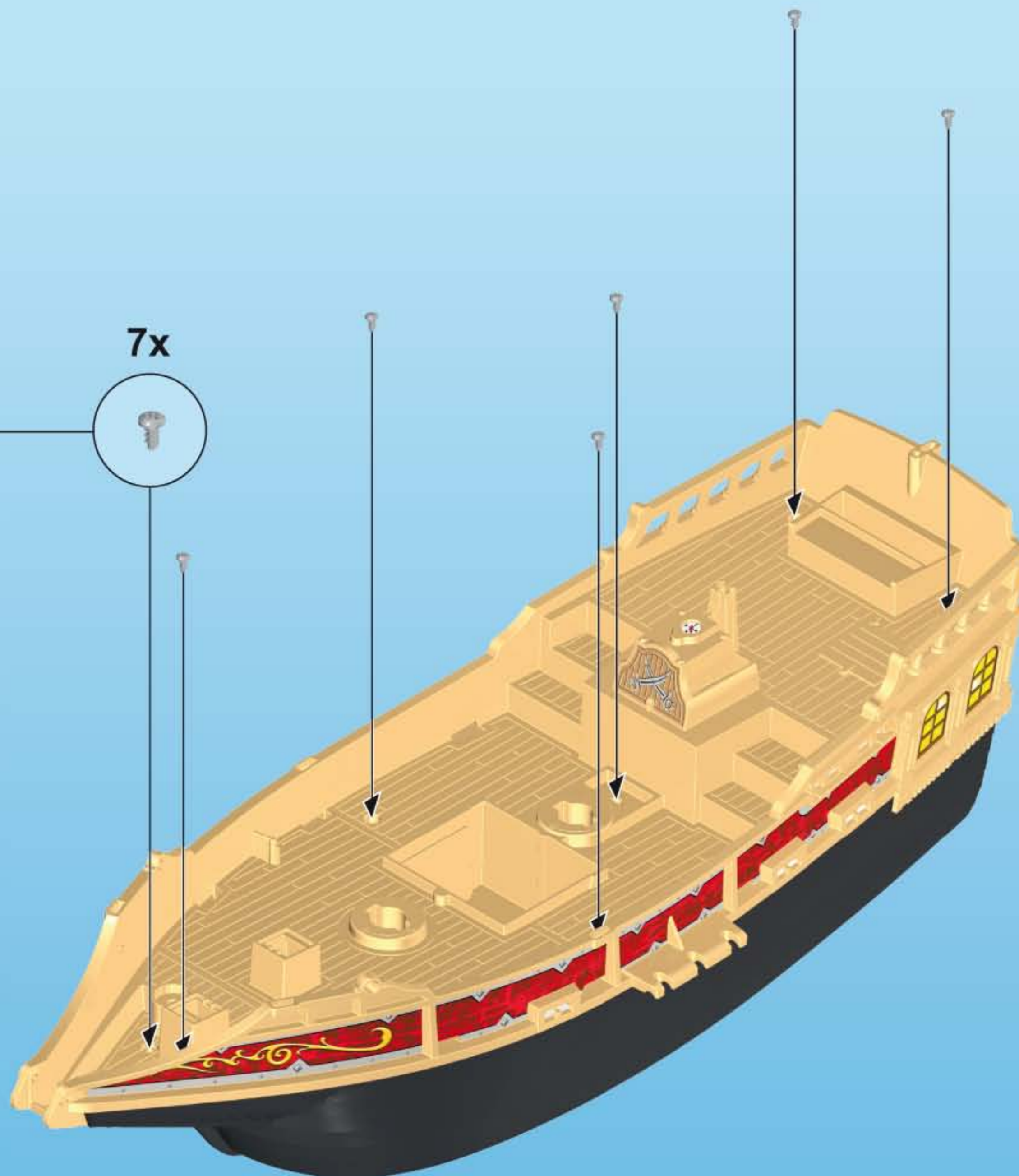



5

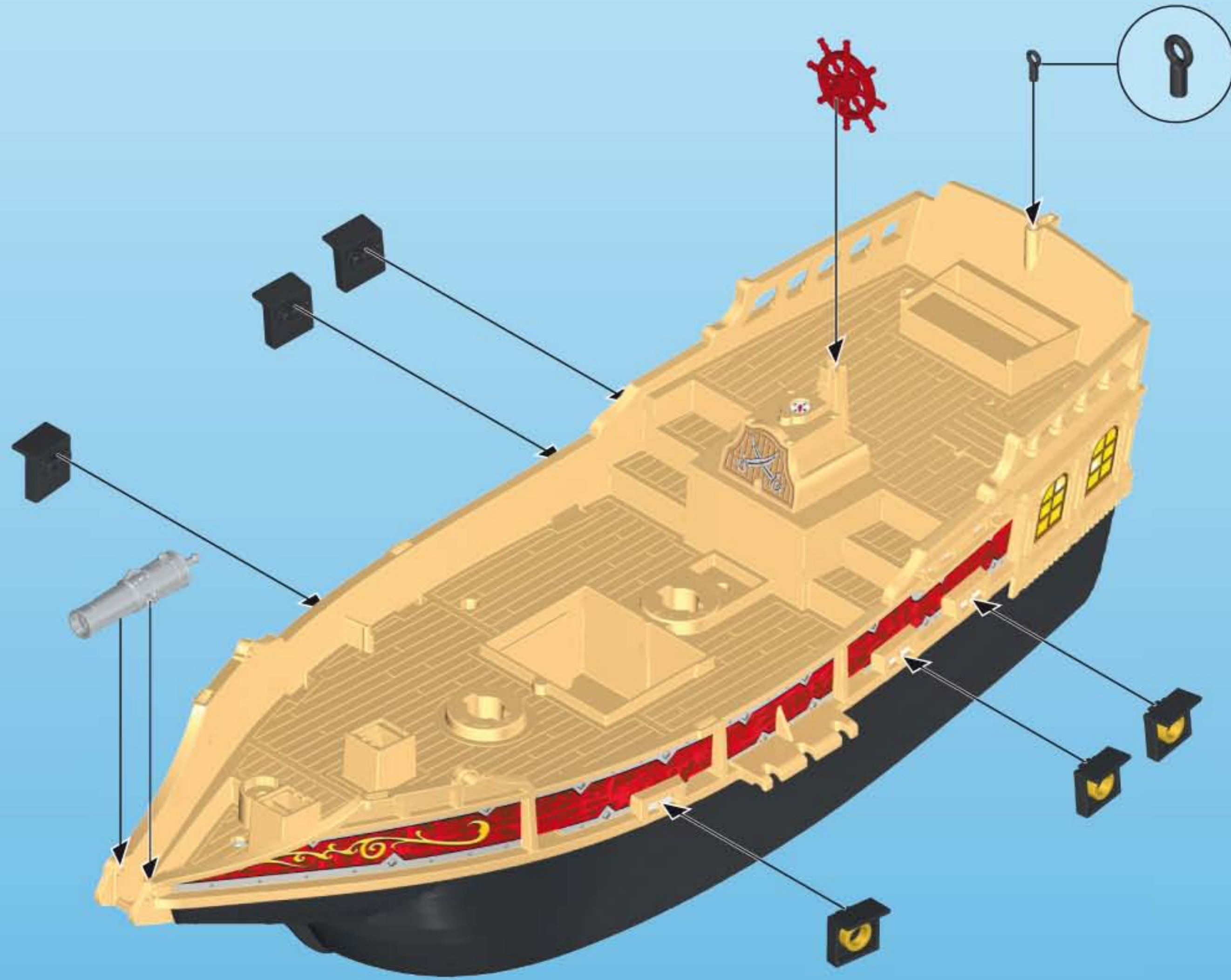



6

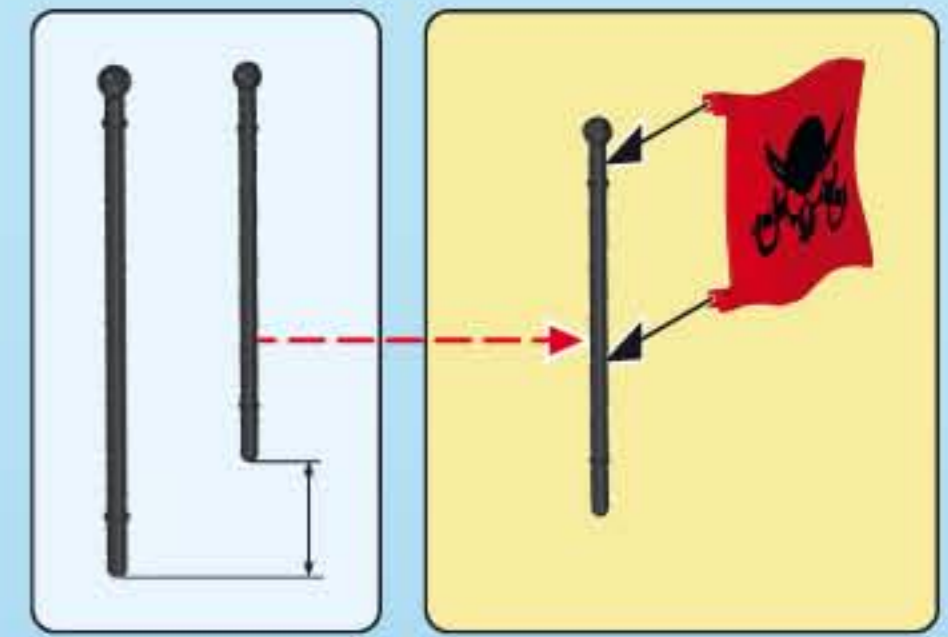
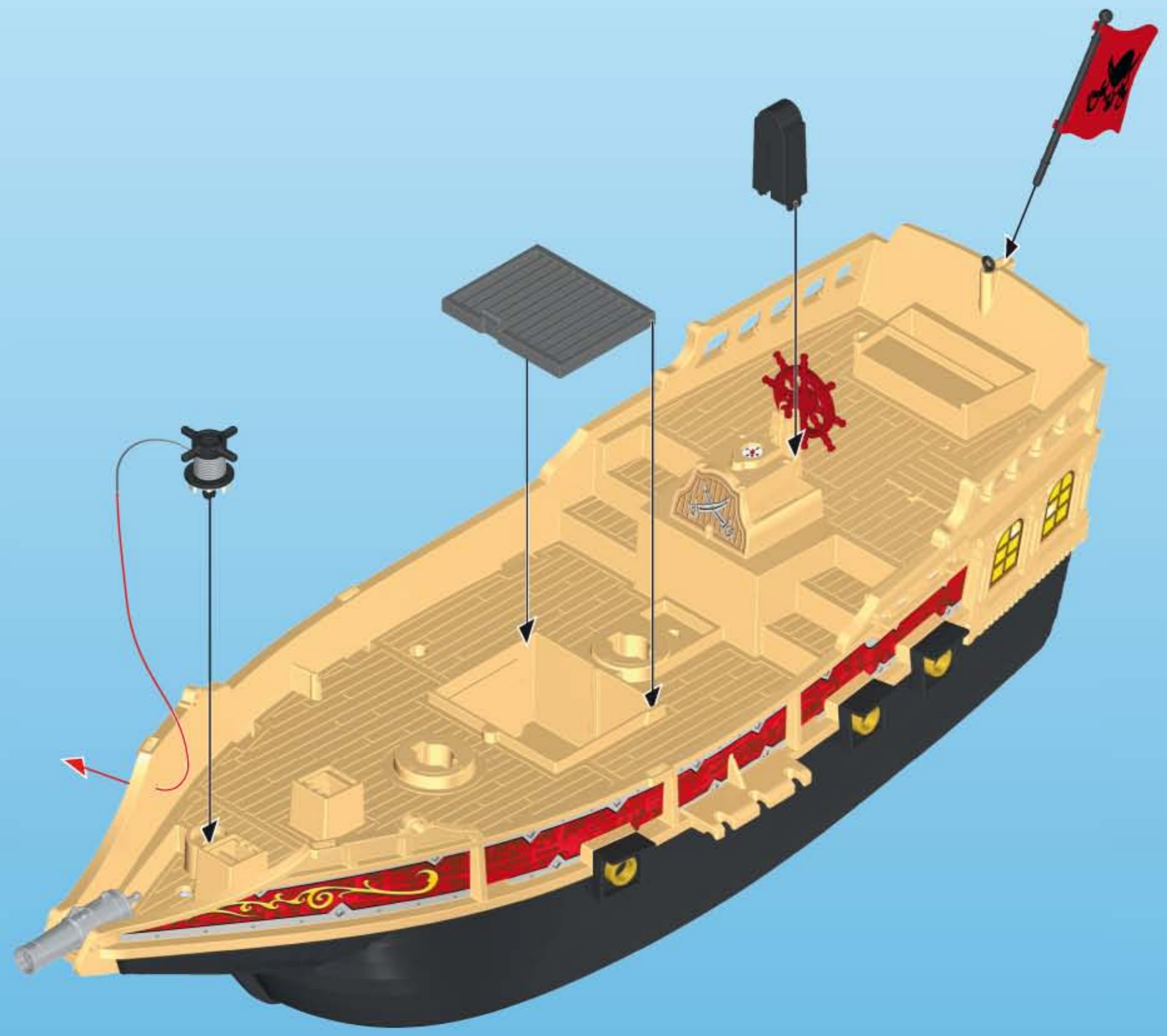
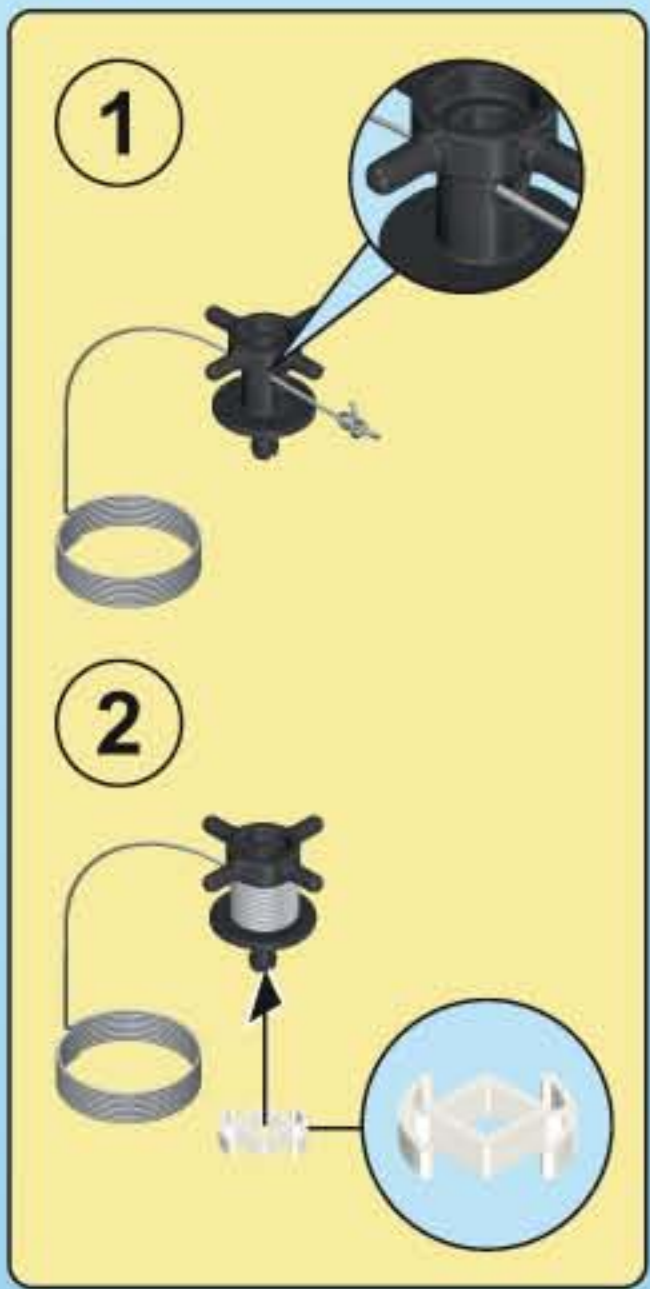



7

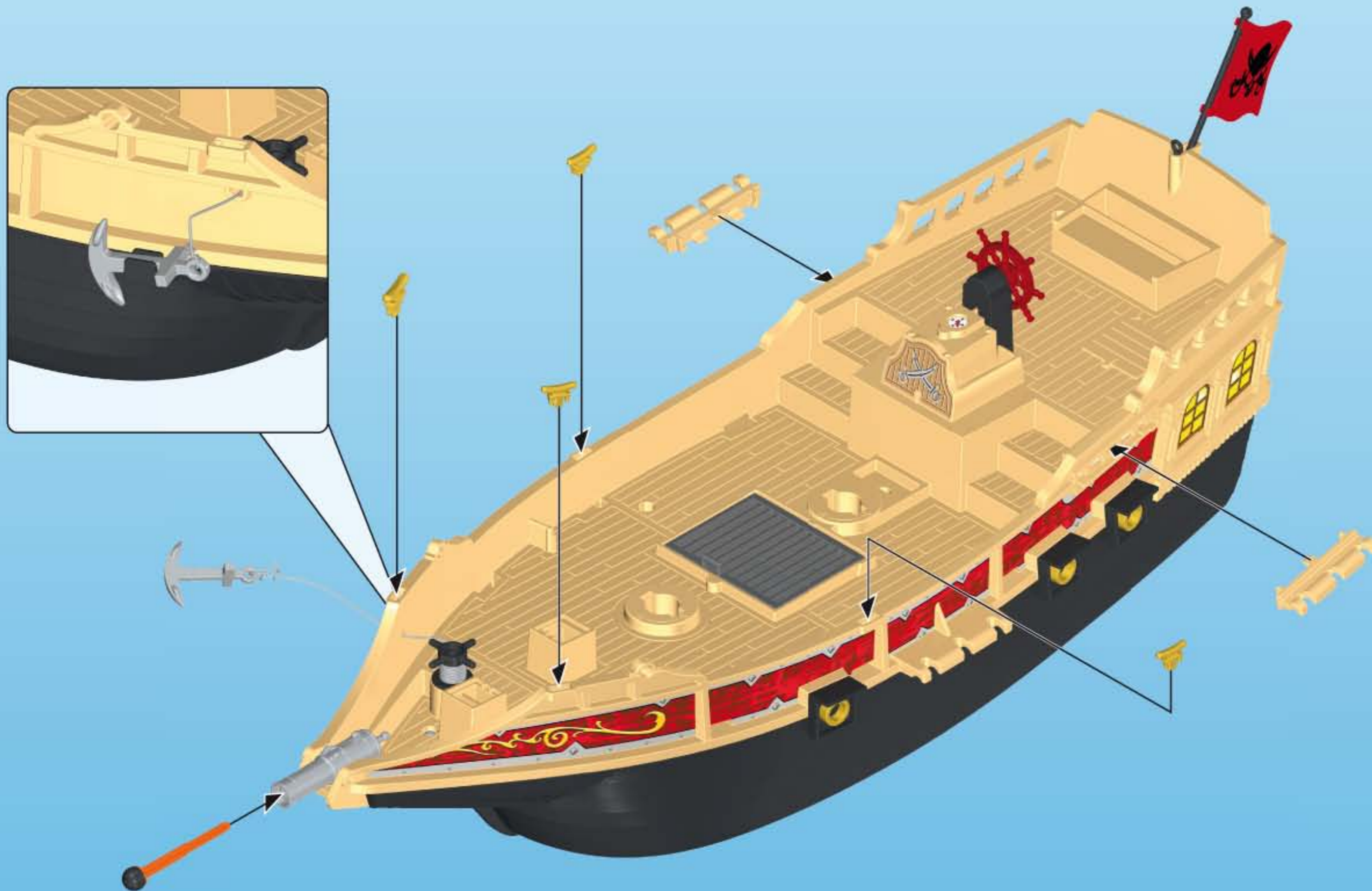

**(D) (A) (CH) (L) (B) ACHTUNG!** Nur mitgelieferte PLAYMOBIL Geschosse verwenden. Nicht auf Augen oder Gesicht zielen.

**(USA) (GB) (CDN) (M) (IRL) WARNING!** Only use the PLAYMOBIL projectiles supplied. Do not aim at eyes or face.

**(F) (CDN) (B) (L) (CH) ATTENTION!** Seulement utiliser les projectiles PLAYMOBIL fournis. Ne pas viser les yeux ou le visage

**(E) (MEX) ¡ADVERTENCIA!** Utiliza únicamente los proyectiles PLAYMOBIL suministrados. No apuntar a los ojos ni a la cara.

**(NL) (B) WAARSCHUWING!** Uitsluitend meegeleverde PLAYMOBIL delen gebruiken. Niet op ogen of gezicht richten.

**(I) (CH) AVVERTENZA!** Usare soltanto i proiettili PLAYMOBIL in dotazione. Non mirare agli occhi o al viso.

**(P) ATENÇÃO!** Usar apenas os projéteis PLAYMOBIL juntamente fornecidos. Não apontar para os olhos ou face.

**(DK) ADVARSEL!** Anvend kun de medfølgende PLAYMOBIL projektiler. Sigst ikke mod øjne eller ansigt.

**(N) ADVARSEL!** Benytt kun PLAYMOBIL prosjektil som leveres med. Sikt ikke på ansikt eller øyne.

**(S) (FIN) VARNING!** Använd endast medlevererade PLAYMOBIL-skott. Sikta inte mot ögon eller ansikte.

**(FIN) VAROITUS!** Käytä vain mukana toimitettuja PLAYMOBIL-ammuksia. Ei saa kohdistaa suoraan silmiin tai kasvoihin.

**(H) FIGYELMEZTETÉS.** Csak a csomagban található PLAYMOBIL lövedékeket szabad használni. Tilos szemre vagy arcra célozni.

**(CZ) UPOZORNĚNÍ!** Používejte pouze střely PLAYMOBIL, které jsou součástí dodávky. Nemířte na oči nebo na obličej!

**(EST) HOIATUS!** Kasutage ainult kaasaantud PLAYMOBIL'i laskemoona. Ära sihi silmadesse ega näkku.

**(LV) BRĪDINĀJUMS!** Izmantot tikai PLAYMOBIL piegādes komplektā iekļautos šāviņus. Nevērst pret acīm vai seju.

**(LT) ĮSPĖJIMAS!** Naudokite tik pridėdamus PLAYMOBIL šaudmenis. Netaikyti į akis arba veidą.

**(SLO) OPOZORILO!** Uporabljajte le priložene PLAYMOBIL-ove krogle. Ne merite v oči ali obraz.

**(SK) UPOZORNENIE!** Používajte len náboje dodávané spolu so sadou PLAYMOBIL. Nemieriť do očí alebo do tváre.

**(PL) OSTRZEŻENIE!** Stosować tylko załączone PLAYMOBIL - kule / pociski. Nie celować w oczy i twarz.

**(TR) (CY) ΔΙΚΚΑΤ!** Sadece birlikte verilen PLAYMOBIL mermileri kullanınız. Göze veya yüze doğru tutmayınız.

**(GR) (CY) Προειδοποίηση!** Να χρησιμοποιούνται αποκλειστικά τα βλήματα της PLAYMOBIL που περιέχονται στη συσκευασία. Μη μην γίνεται στόχευση στα μάτια ή στο πρόσωπο.

**(RO) AVERTISMENT!** Se folosesc doar proiectilele incluse PLAYMOBIL. Nu se țintește în ochi sau în față.

**(BG) Внимание!** Използвайте само приложени PLAYMOBIL снаряди. Не насочвайте към очите и лицето.

**(HR) UPOZORENJE!** Upotrijebiti samo od strane PLAYMOBIL-a isporučene projekte. Ne ciljati u oči ili lice.

**(CN) 警告!** 仅能用PLAYMOBIL的炮弹。禁止瞄准眼睛或脸。请勿瞄准眼睛或脸。



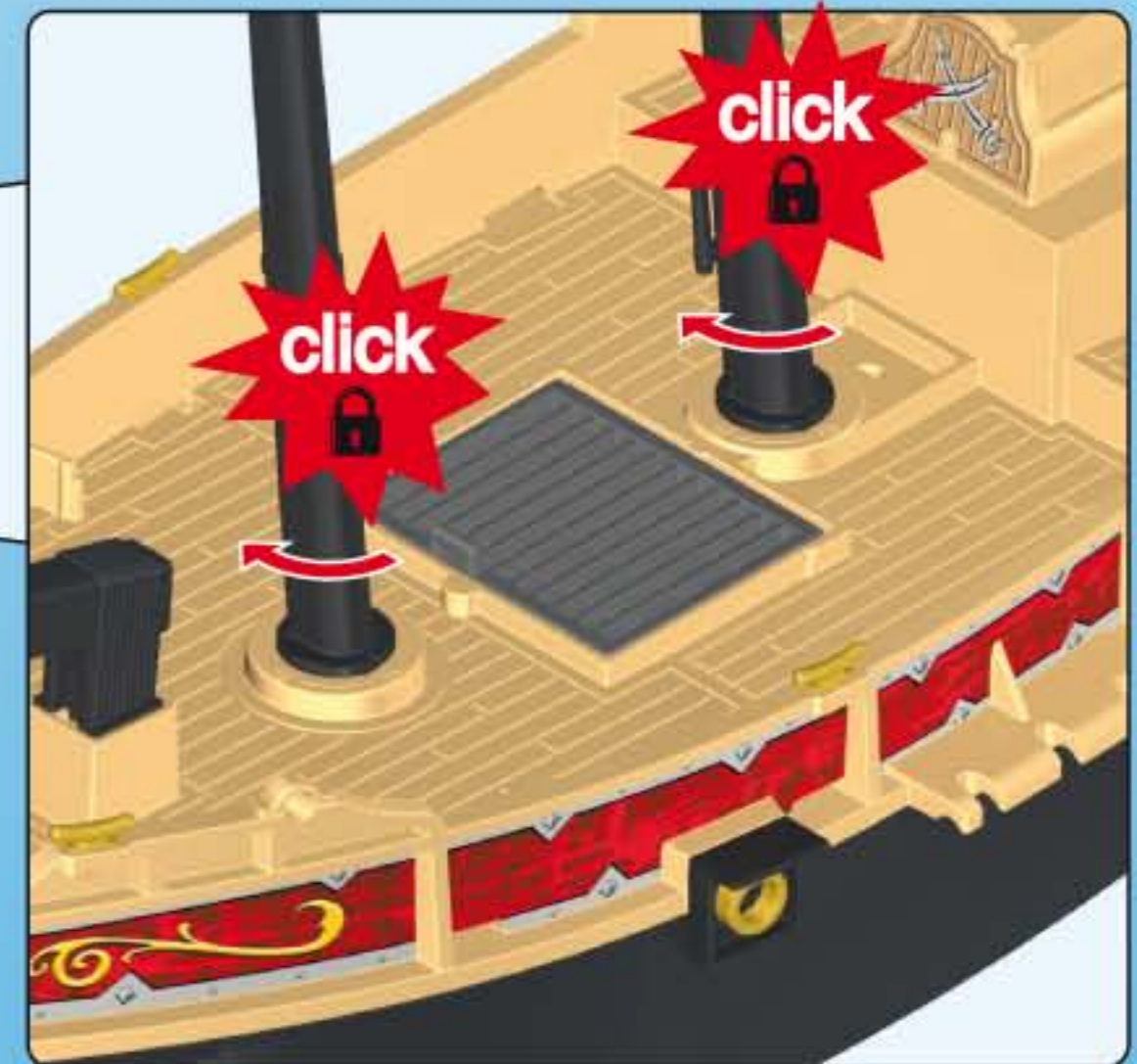



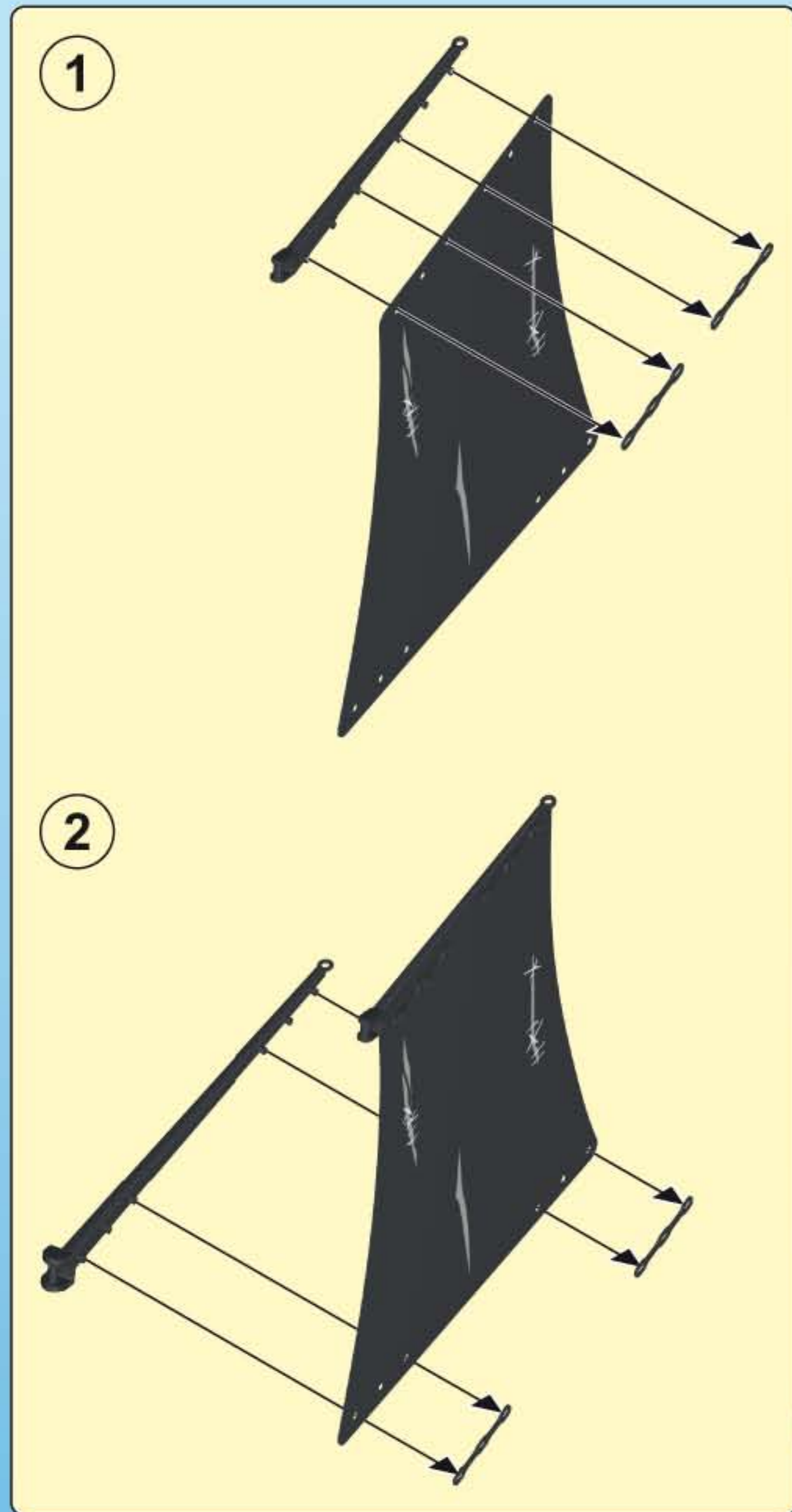

9

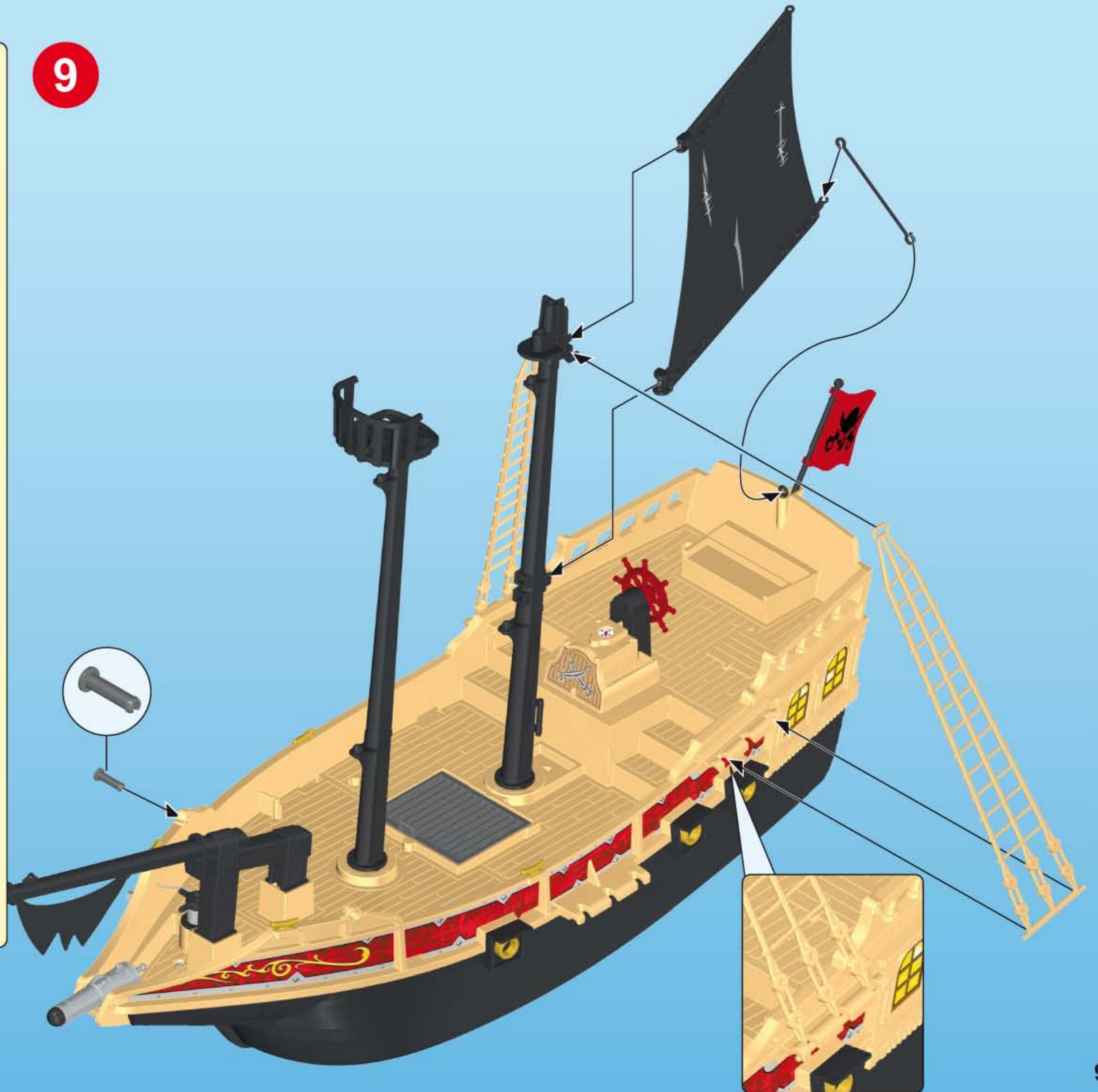



10

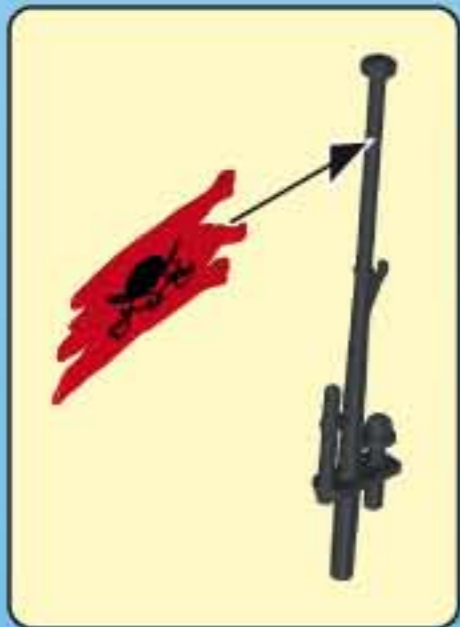
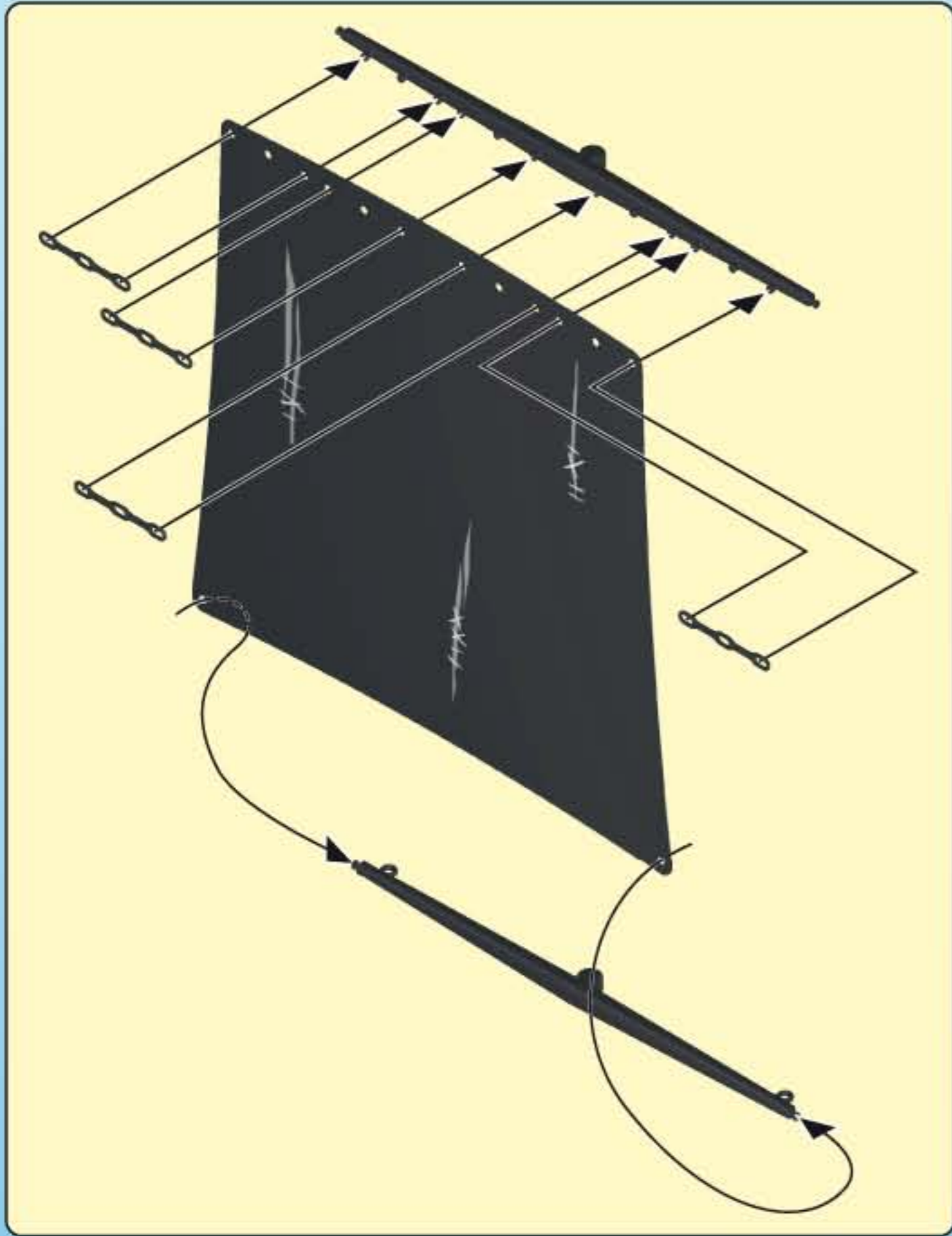



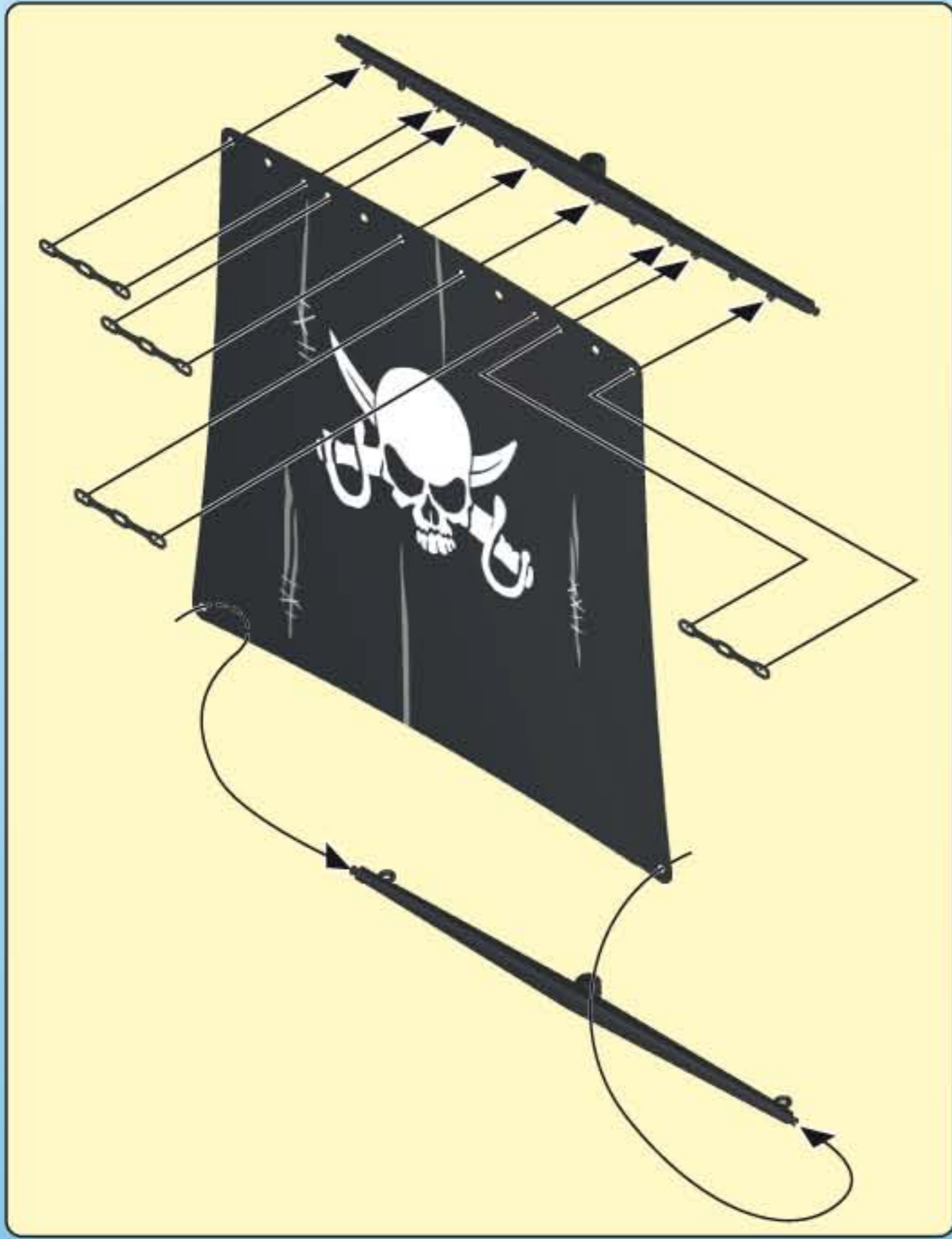



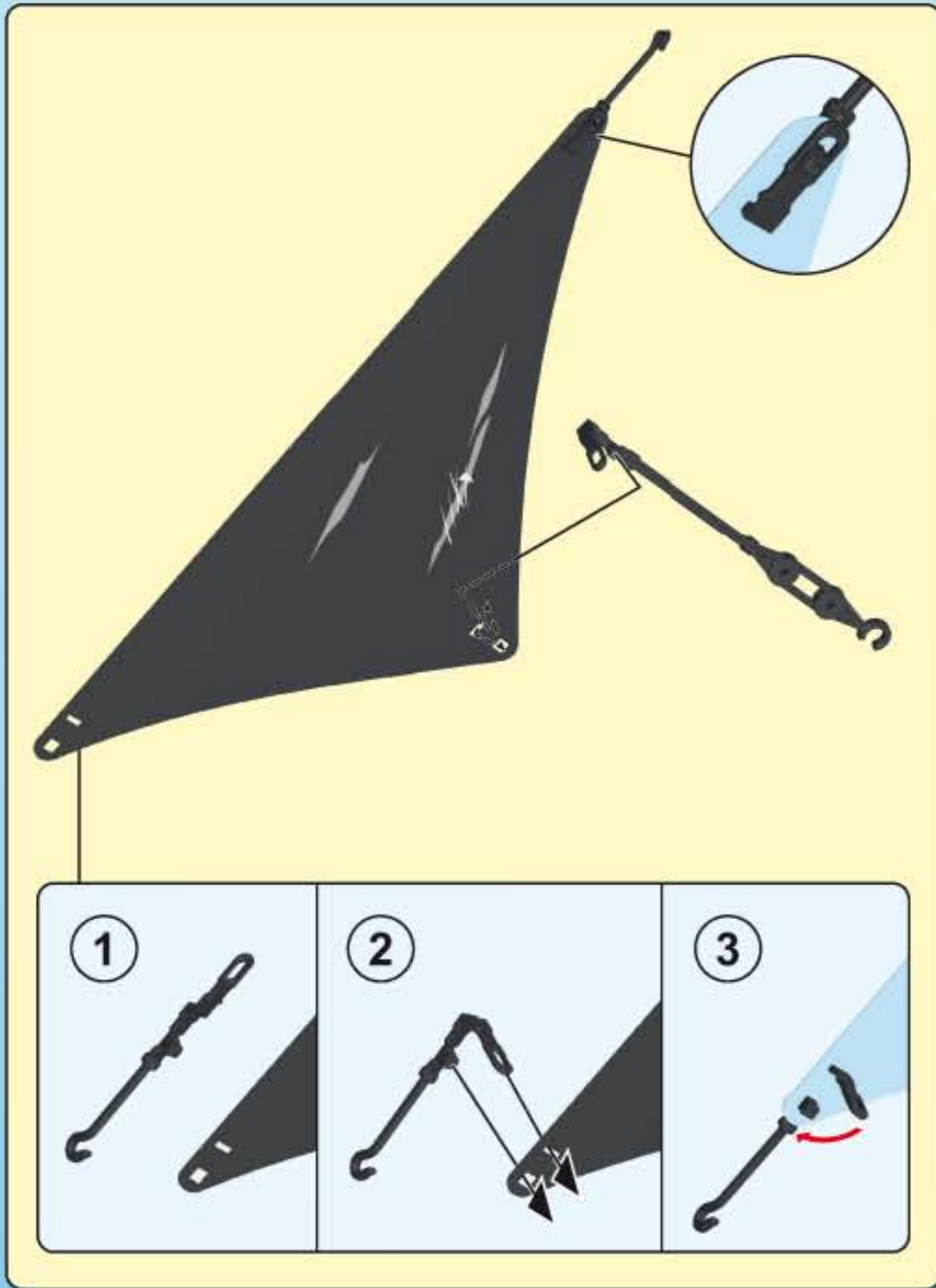



6678 + 5536 + ! 6241

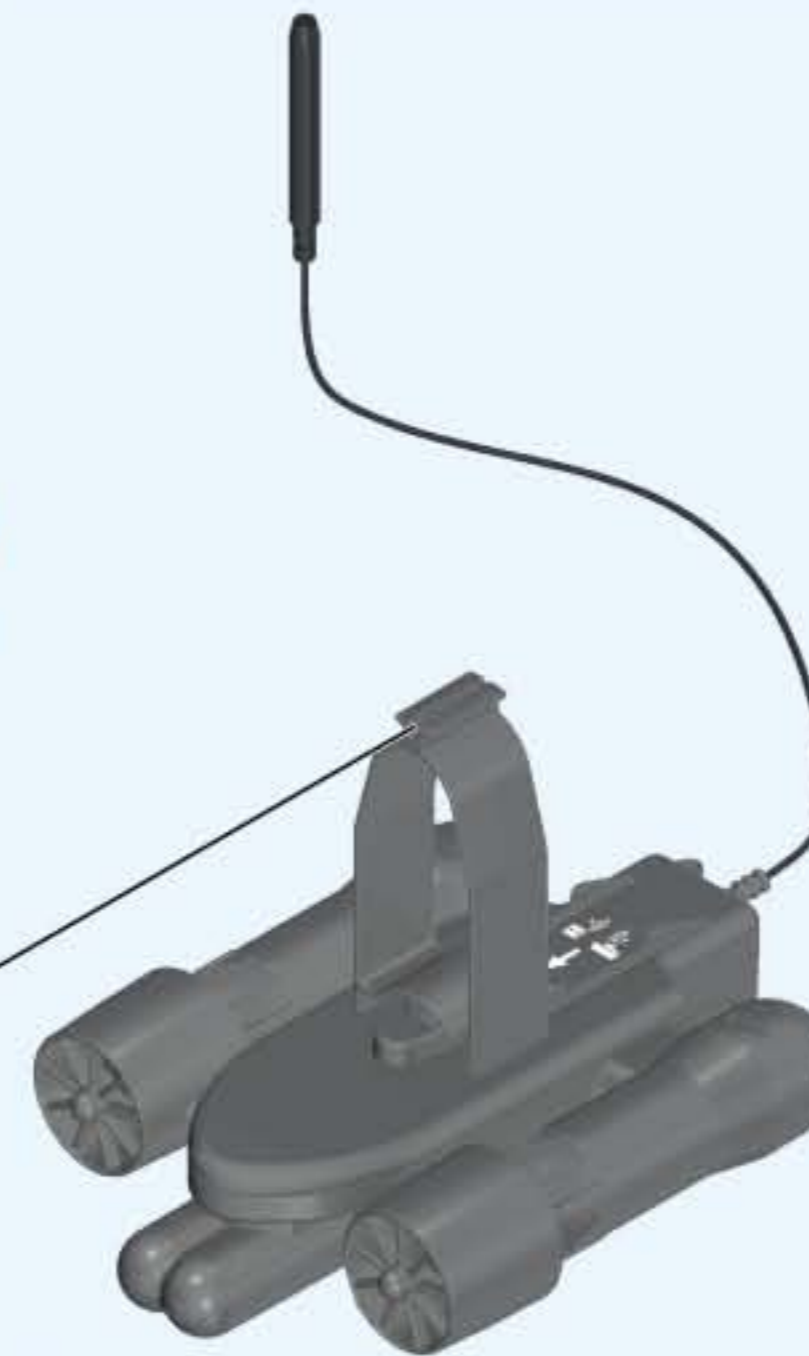

5536

6241

6678

- (D) (A) (CH) (L) (B) Anbaumöglichkeiten des RC-UW-Motors finden Sie unter: [RC-Motor.playmobil.com](http://RC-Motor.playmobil.com)
- (USA) (GB) (CDN) (M) (IRL) For RC UW motor attachment possibilities, visit: [RC-Motor.playmobil.com](http://RC-Motor.playmobil.com)
- (F) (CDN) (B) (L) (CH) Vous trouverez des informations complémentaires sur le site Internet: [RC-Motor.playmobil.com](http://RC-Motor.playmobil.com)
- (E) (MEX) Las posibilidades de montaje del motor submarino RC se pueden consultar en: [RC-Motor.playmobil.com](http://RC-Motor.playmobil.com)
- (NL) (B) Aanbouwmogelijkheden van de RC-Onderwatermotor vindt u op: [RC-Motor.playmobil.com](http://RC-Motor.playmobil.com)
- (I) (CH) Le possibilità di montaggio del motore RC-UW sono descritte al sito: [RC-Motor.playmobil.com](http://RC-Motor.playmobil.com)
- (P) As possibilidades de montagem do motor RC subaquático pode ser consultadas em: [RC-Motor.playmobil.com](http://RC-Motor.playmobil.com)
- (DK) Montagemuligheder for RC-UW-motoren finder du på: [RC-Motor.playmobil.com](http://RC-Motor.playmobil.com)
- (N) Monteringsmuligheter for RC-UW-motoren finner du under: [RC-Motor.playmobil.com](http://RC-Motor.playmobil.com)
- (S) (FIN) RC-undervattensmotorns monteringsmöjligheter hittar du på: [RC-Motor.playmobil.com](http://RC-Motor.playmobil.com)
- (FIN) Vedenalaisen RC-moottorin asennusmahdollisuuksia löytyy osoitteesta: [RC-Motor.playmobil.com](http://RC-Motor.playmobil.com)
- (H) Az RC-UW- Motor hozzáépítési lehetőségeiről az [RC-Motor.playmobil.com](http://RC-Motor.playmobil.com) alatt talál anyagot.
- (CZ) Možnosti instalace lodního motoru s dálkovým ovládním najdete na internetové adrese [RC-Motor.playmobil.com](http://RC-Motor.playmobil.com)
- (EST) RC-UW-Motor'i paigaldusjuhised leiate aadressil: [RC-Motor.playmobil.com](http://RC-Motor.playmobil.com)
- (LV) Informāciju par RC-UW motora montāžas iespējām skati vietnē: [RC-Motor.playmobil.com](http://RC-Motor.playmobil.com)
- (LT) RC UW variklio pritvirtinimo galimybes pateikiamos tokiam internetiniame puslapyje: [RC-Motor.playmobil.com](http://RC-Motor.playmobil.com)
- (SLO) Možni načini namestitve daljinsko krmiljenega (RC) podvodnega (UW) motorja so na voljo na naslovu: [RC-Motor.playmobil.com](http://RC-Motor.playmobil.com)
- (SK) Možnosti inštalácie lodného motoru s diaľkovým ovládním nájdete na internetovej adrese [RC-Motor.playmobil.com](http://RC-Motor.playmobil.com)
- (PL) Możliwości zastosowania podwodnego silnika RC znajdują się na stronie: [RC-Motor.playmobil.com](http://RC-Motor.playmobil.com)
- (TR) (CY) Uzaktan kumandali su altı motorunun montaj kılavuzu [RC-Motor.playmobil.com](http://RC-Motor.playmobil.com) sayfasında gösterilmiştir
- (GR) (CY) Οδηγίες συναρμολόγησης του τηλεκατευθυνόμενου μοτέρ με υπέρυθρες ακτίνες θα βρείτε στην ηλεκτρονική διεύθυνση: [RC-Motor.playmobil.com](http://RC-Motor.playmobil.com)
- (RO) Posibilități de montare a motorului submersibil cu telecomandă se găsesc pe site-ul: [RC-Motor.playmobil.com](http://RC-Motor.playmobil.com)
- (BG) Възможности за допълнително оборудване на RC-електромотора за под вода можете да намерите на адрес: [RC-Motor.playmobil.com](http://RC-Motor.playmobil.com)
- (HR) Mogućnosti dogradnje RC-UW-Motora ćete pronaći pod: [RC-Motor.playmobil.com](http://RC-Motor.playmobil.com)
- (CN) 了解红外线水下电机的安装方法请访问以下网站：  
[RC-Motor.playmobil.com](http://RC-Motor.playmobil.com)



**D A CH L B ACHTUNG!**

- Nur im flachen Wasser unter Aufsicht von Erwachsenen verwenden. Nach dem Spielen austrocknen lassen.

**USA GB CDN M IRL WARNING!**

- Only to be used in water in which the child is within its depth and under adult supervision. Dry thoroughly after play.

**F CDN B L CH ATTENTION!**

- À n'utiliser qu'en eau où l'enfant a pied et sous la surveillance d'un adulte. Faire sécher après chaque utilisation.

**E MEX ¡ADVERTENCIA!**

- Utilizar sólo en agua donde el niño pueda permanecer de pie y bajo vigilancia de un adulto. Dejar secar antes de guardar.

**NL B WAARSCHUWING!**

- Gebruiken in water waar kinderen kunnen staan en onder toezicht van volwassenen. Na het spelen laten drogen.

**I CH AVVERTENZA!**

- Da utilizzare unicamente in acqua dove il bambino tocca il fondo con i piedi e sotto la sorveglianza di un adulto. Asciugare bene dopo ogni uso.

**P ATENÇÃO!**

- Só utilizar em água onde a criança tenha pé e sob vigilância de adultos. Deixar secar antes de guardar.

**DK ADVARSEL!**

- Må kun anvendes under opsyn af en voksen og på vanddybder, hvor barnet kan bunde. Lad det tørre ud når du er færdig med at lege.

**N ADVARSEL!**

- Skal kun brukes i vann som ikke er for dypt for barnet, og der barnet er under tilsyn. Tørk opp etter at leken er ferdig.

**S FIN VARING!**

- Får endast användas i vatten där barnet bottnar och under tillsyn av en vuxen. Låt torka efter användandet.

**FIN VAROITUS!**

- Lelua saa käyttää vain aikuisen valvonnassa vedessä, jossa lapsi ylettyy pohjaan. Anna kuivua leikin jälkeen.

**H FIGYELMEZTETÉS.**

- Csak a gyermek magasságához képest biztonságos sekély vízben és felnőtt felügyelete mellett szabad használni! Játék után ajánlott a termék kiszáradtása!

**CZ UPOZORNĚNÍ!**

- Používat pouze ve vodě takové hloubky, kde dítě stačí, a pouze pod dohledem dospělé osoby. Po hraní nechat vyschnout.

**EST HOIATUS!**

- Kasutada ainult täiskasvanu järelvalve all vees, kus laps ulatub jalgadega põhja. Mängimise järel kuivatada!

**LV BRĪDINĀJUMS!**

- Lietot tikai sekļā ūdenī un pieaugušo uzraudzībā. Pēc spēlēšanās ļaut nožūt.

**LT ĮSPĖJIMAS!**

- Naudoti tik vaikai tinkamame gylyje ir prižiūrint suaugusiųsiems. Pažaidus, išdžiovinkite.

**SLO OPOZORILO!**

- Uporabljajte samo v vodi, primerno plitvi za otroka in pod nadzorom odrasle osebe. Po igri naj se igrača posuši.

**SK UPOZORNENIE!**

- Používať len vo vode, v ktorej dieťa dočiahne na dno, a pod dohľadom dospeléj osoby. Po hre nechať vyschnúť.

**PL OSTRZEŻENIE!**

- Do używania jedynie w wodzie na głębokości, na której dziecko wyczuwa dno pod nogami oraz pod nadzorem osoby dorosłej. Po zabawie pozostaw do wyschnięcia.

**TR CY DİKKATI!**

- Sadece denetim altında ve sadece alçak sularda kullanın. Oyundan sonra kurumaya bırakın.

**GR CY Προειδοποίηση!**

- Να χρησιμοποιείται μόνο σε νερά όπου πατώνει το παιδί και υπό την επίβλεψη ενήλικου. Μόλις τελειώσετε, αφήστε το παιχνίδι να στεγνώσει εντελώς.

**RO AVERTISMENT!**

- A se utilizează numai acolo unde copilul poate sta în picioare în apă și este sub supraveghere. După joacă se lasă să se usuce.

**BG Внимание!**

- Да се използва само във вода, която е дълбока до нормалния ръст на детето, и под надзора на възрастен. След игра оставете да изсъхне.

**HR UPOZORENJE!**

- Koristiti samo u plitkoj vodi pod nadzorom odraslih. Poslije igranja pustiti da se osuši.

**CN 警告!**

- 可供孩子在水中使用，但必须在有人监护的情况下。玩耍后要干燥。

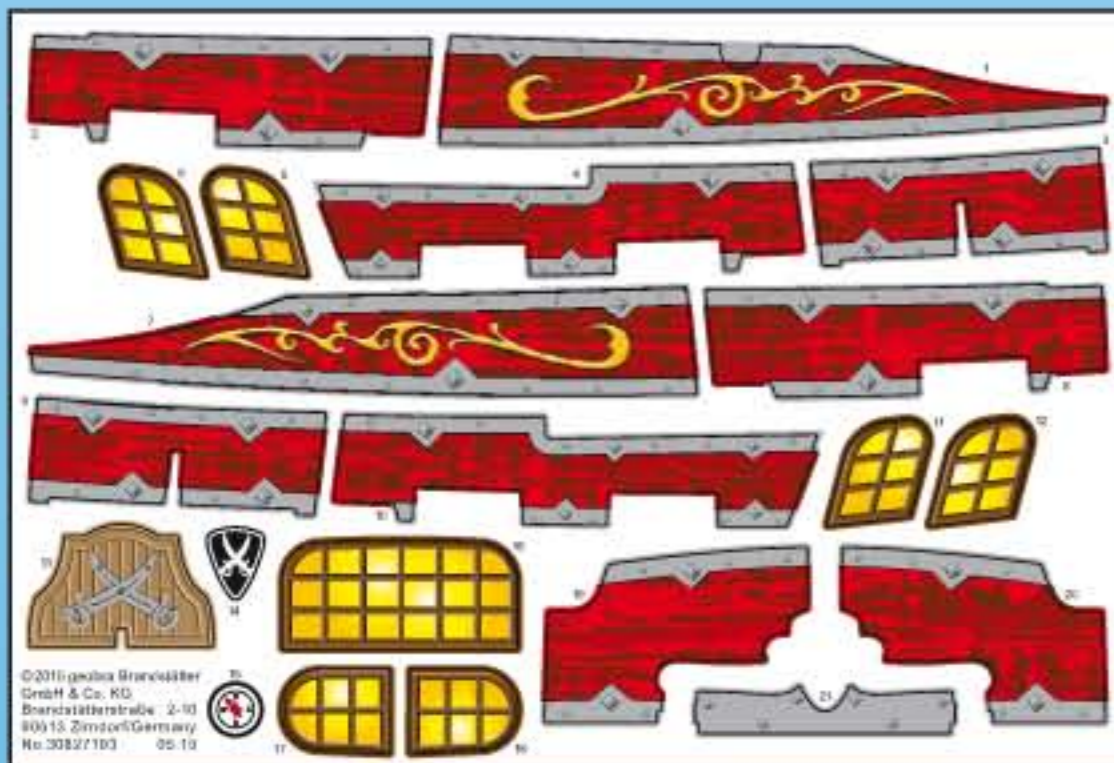
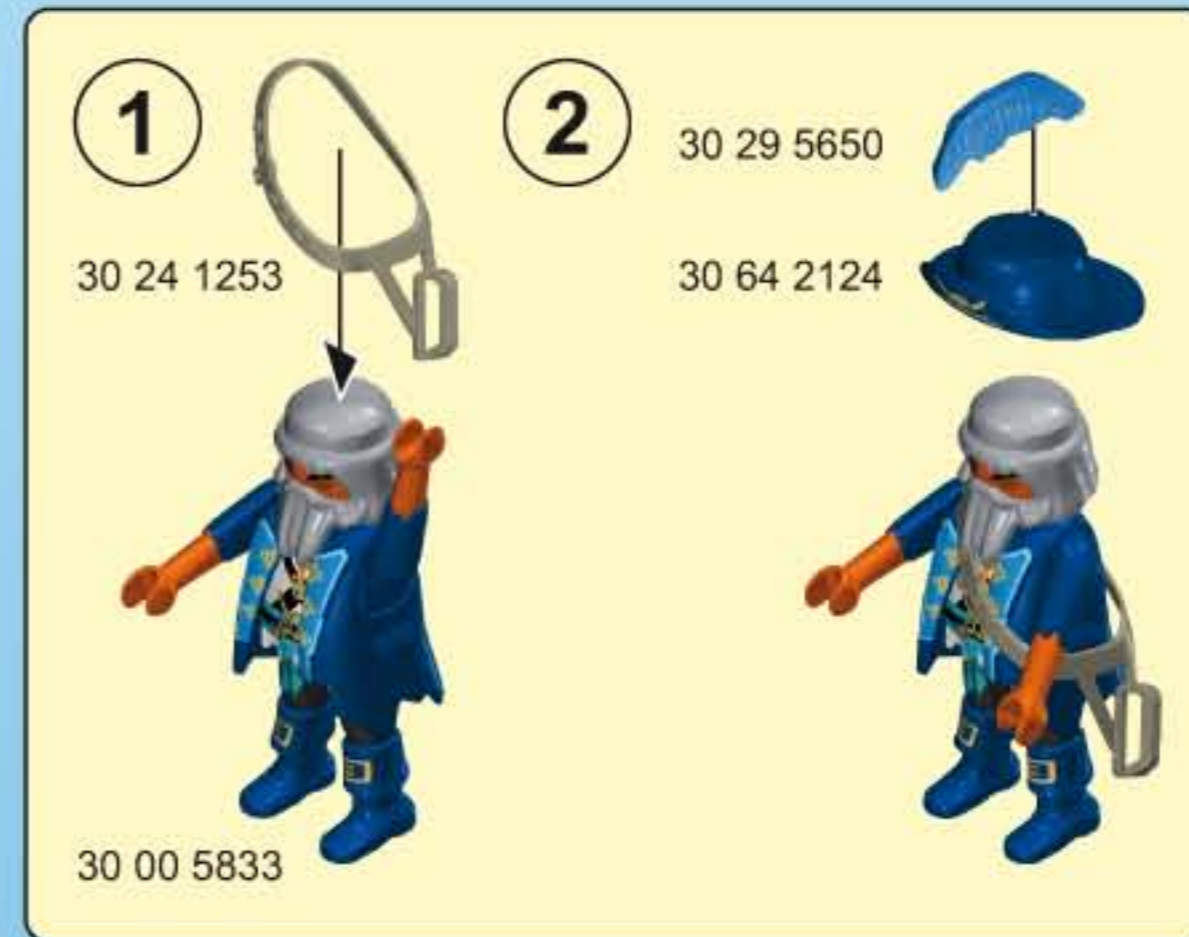
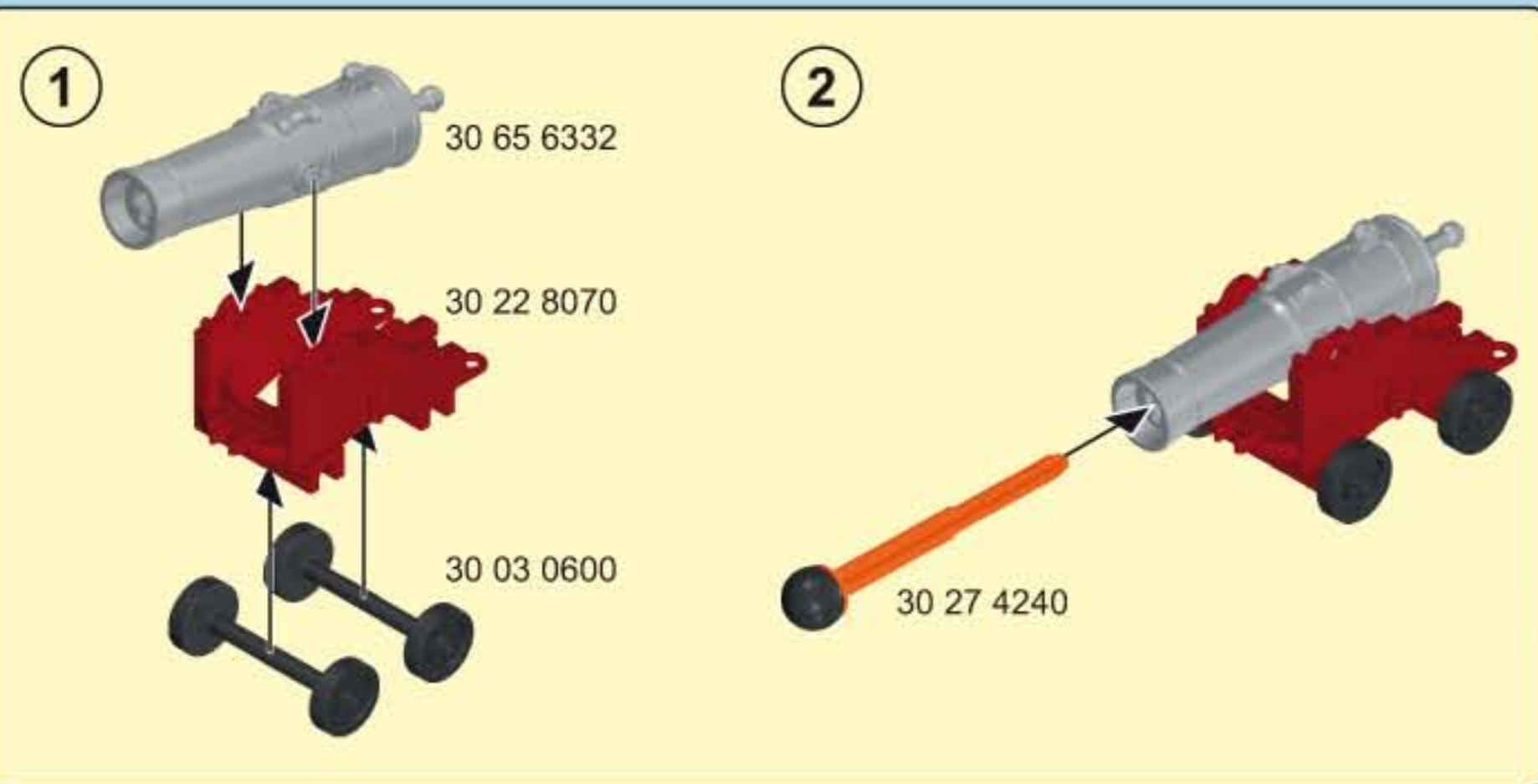

30 82 7193



30 09 5440



30 29 9510



2x 30 29 2540



30 21 8330



30 20 5423



30 00 5823



30 24 0583



30 00 5843

2x 30 21 9010



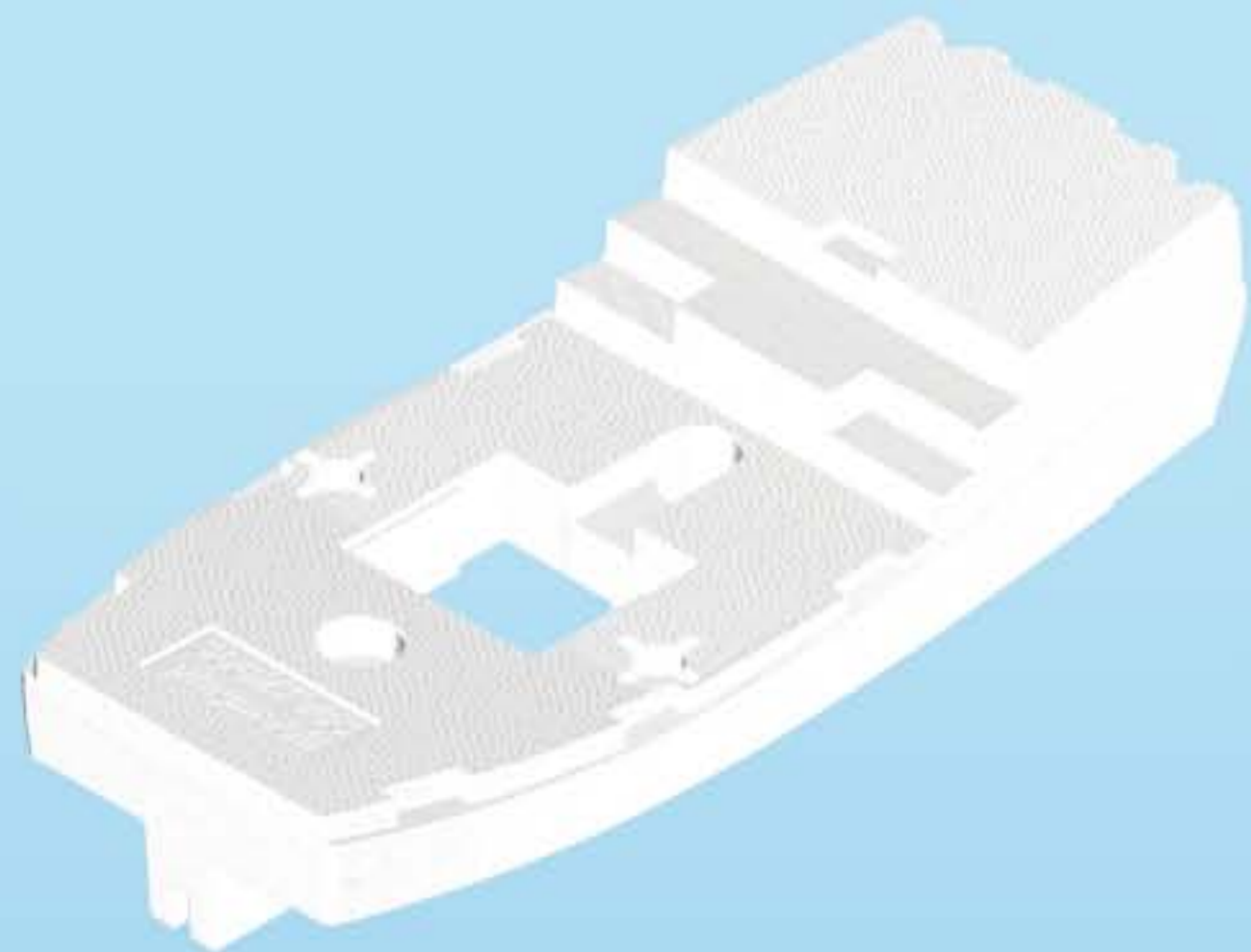

30 82 7983

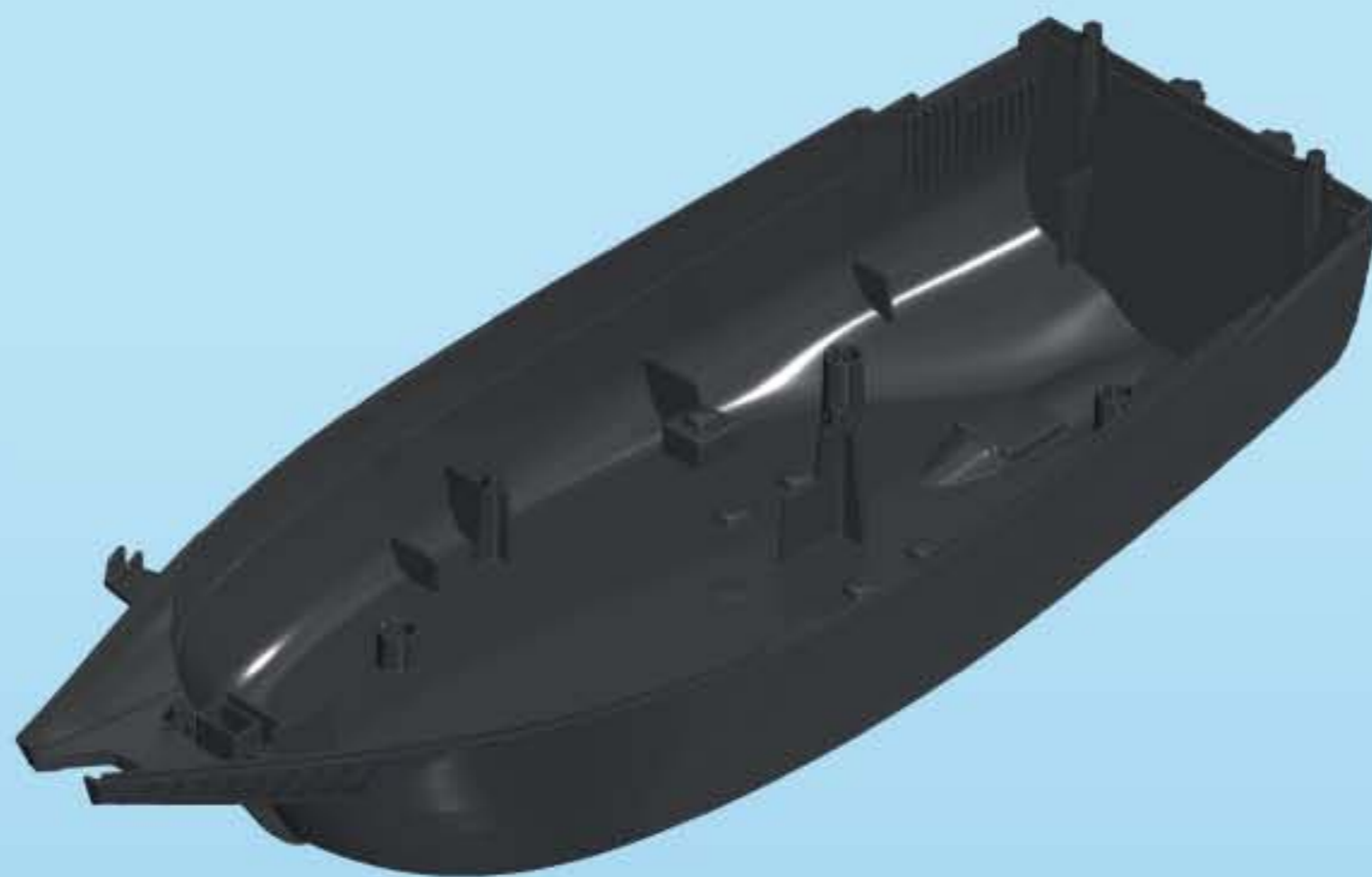

30 24 1303



30 82 7213



30 82 7223



30 24 1183



30 45 6870



30 45 6590

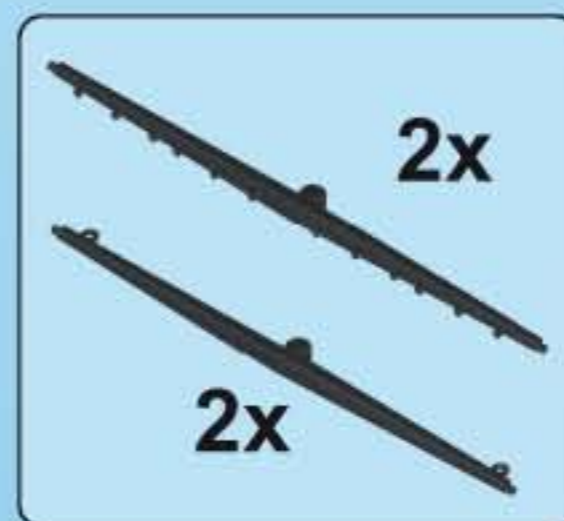

30 51 4912



30 82 7203



30 82 7233

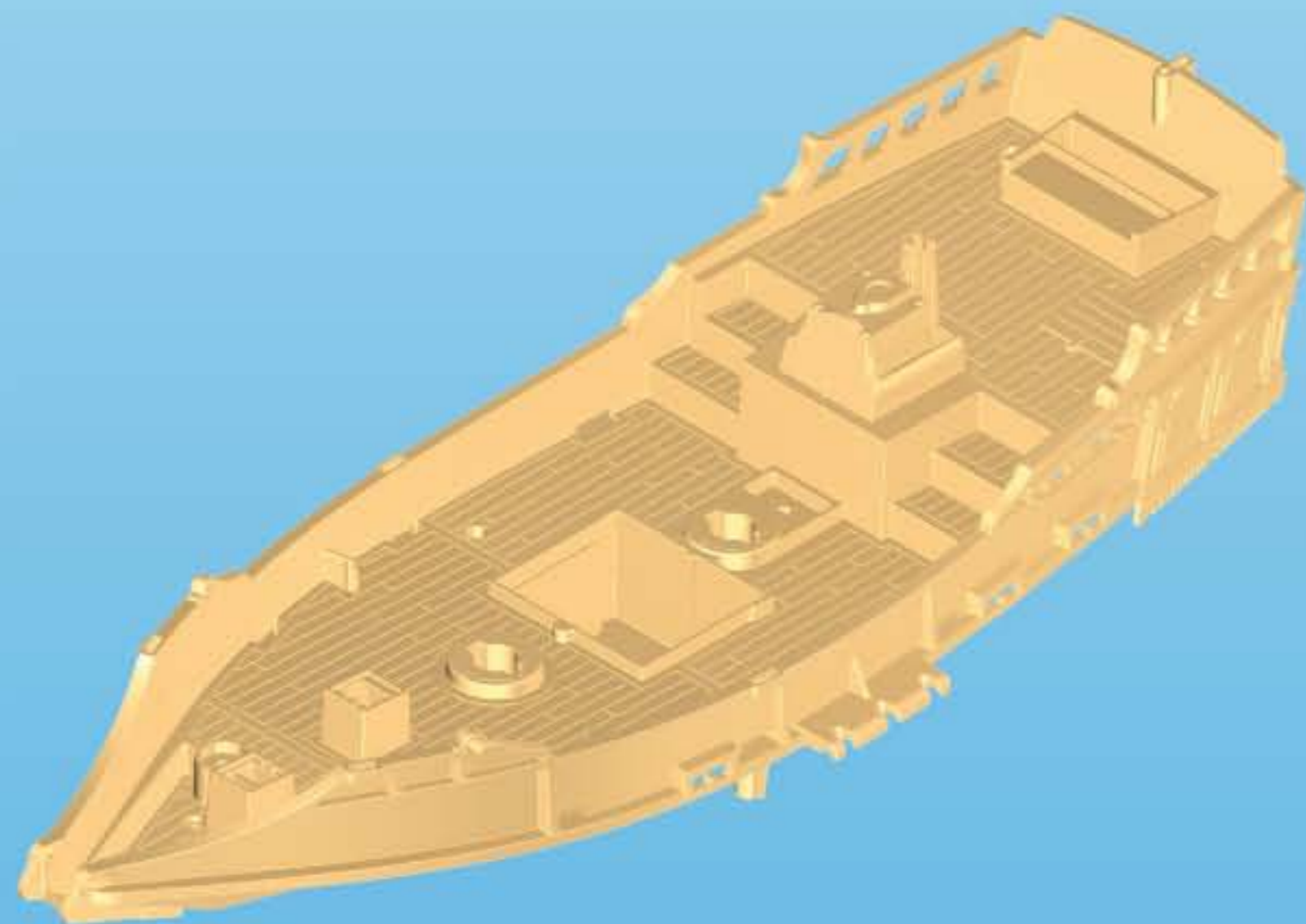

30 24 1153



30 67 7412



30 45 6580

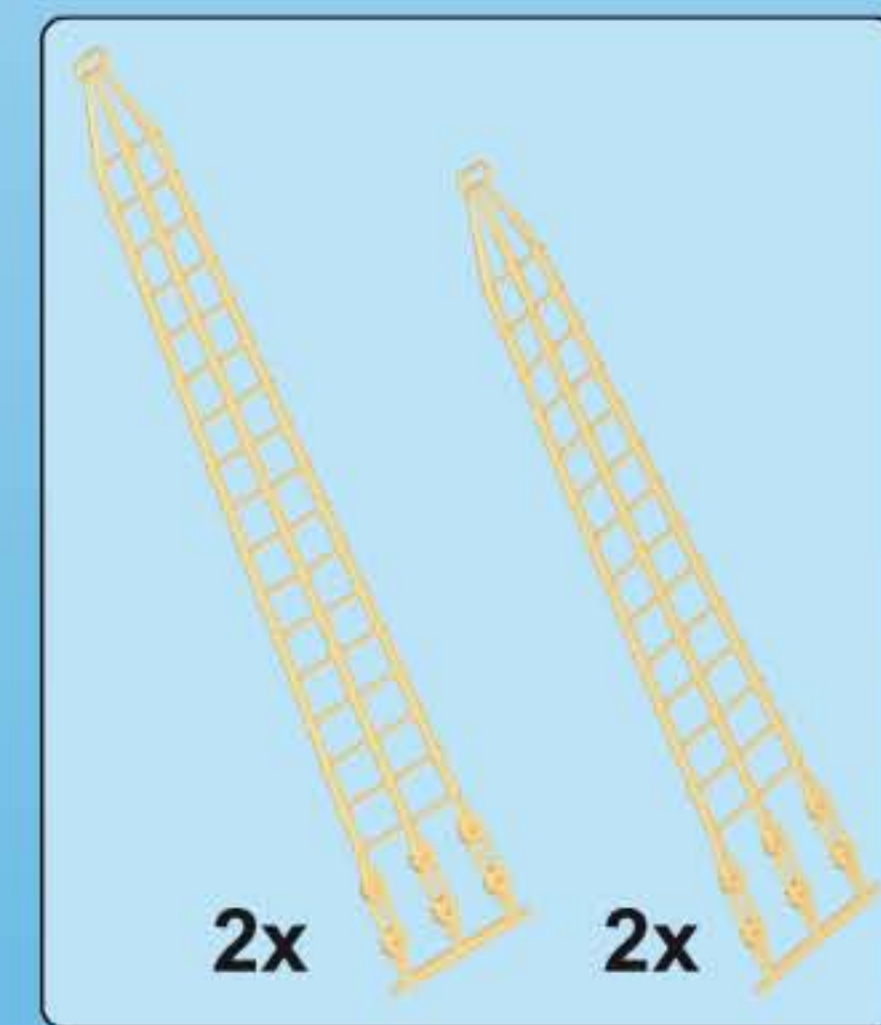

30 51 4802





30 24 1173



30 45 6880

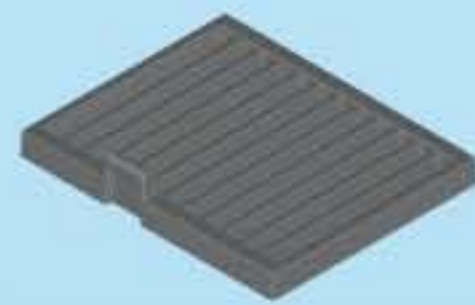

30 21 8850



30 24 1193



30 22 6680

30 24 1782



30 23 3812



30 65 6332



3x 30 27 4240



30 22 8722



30 64 2084



30 64 2074



2x 30 28 2270



2x 30 28 2110

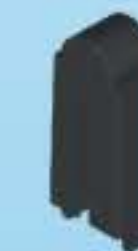

30 22 8572



2x 30 22 8212



30 21 2842



30 88 3560



30 21 8880



6x 30 24 1163



30 28 2590



20x 30 28 2120



2x 30 21 8810



2x 30 27 3380



30 24 1143



30 07 5230



30 23 9540



30 27 3920



6x 30 22 7920



7x 30 82 8372