

Adora24 Series

All-in-One (AIO) PC

MS-AE63 System

Contents

Copyright Notice.....	iii
Trademarks	iii
Revision	iii
Upgrade and Warranty	iv
Acquisition of Replaceable Parts	iv
Technical Support	iv
Green Product Features.....	iv
Environmental Policy.....	v
Chemical Substances Information	v
Battery Information.....	v
Safety Instructions.....	vi
CE Conformity.....	viii
FCC-B Radio Frequency Interference Statement	viii
WEEE Statement	viii

1. Overview 1-1

Packing Contents	1-2
System Overview	1-3
Component Replacement & Upgrade	1-9

2. Getting Started..... 2-1

Safety & Comfort Tips	2-2
Hardware Setup	2-3

3. System Operations 3-1

Power Management	3-2
Network Connection (Windows 7).....	3-4
Network Connection (Windows 8.x)	3-7
System Recovery (Windows 7)	3-10
System Recovery (Windows 8.x)	3-20

A. Troubleshooting A-1

Copyright Notice

The material in this document is the intellectual property of MICRO-STAR INTERNATIONAL. We take every care in the preparation of this document, but no guarantee is given as to the correctness of its contents. Our products are under continual improvement and we reserve the right to make changes without notice.

Trademarks

All trademarks are the properties of their respective owners.

Revision

Revision	Date
V1.0	2013/ 08

Upgrade and Warranty

Please note that certain components preinstalled in the product may be upgradable or replaceable by user's request. For any further information about the product users purchased, please contact the local dealer. Do not attempt to upgrade or replace any component of the product if you are not an authorized dealer or service center, since it may cause the warranty void. It is strongly recommended that you contact the authorized dealer or service center for any upgrade or replace service.

Acquisition of Replaceable Parts

Please be noticed that the acquisition of replaceable parts (or compatible ones) of the product users purchased in certain countries or territories may be fulfilled by the manufacturer within 5 years at most since the product has been discontinued, depending on the official regulations declared at the time.

Please contact the manufacturer via <http://support.msi.com/> for the detailed information about the acquisition of spare parts.

Technical Support

If a problem arises with your system and no solution can be obtained from the user's manual, please contact your place of purchase or local distributor. Alternatively, please try the following help resources for further guidance.

- ☐ Visit the MSI website for technical guide, BIOS updates, driver updates and other information via <http://www.msi.com/service/download/>
- ☐ Contact our technical staff via <http://support.msi.com/>

Green Product Features

- ☐ Reduced energy consumption during use and stand-by
- ☐ Limited use of substances harmful to the environment and health
- ☐ Easily dismantled and recycled
- ☐ Reduced use of natural resources by encouraging recycling
- ☐ Extended product lifetime through easy upgrades
- ☐ Reduced solid waste production through take-back policy

Environmental Policy

- ☐ The product has been designed to enable proper reuse of parts and recycling and should not be thrown away at its end of life.
- ☐ Users should contact the local authorized point of collection for recycling and disposing of their end-of-life products.
- ☐ Visit the MSI website and locate a nearby distributor for further recycling information.
- ☐ Users may also reach us at gpcontdev@msi.com for information regarding proper Disposal, Take-back, Recycling, and Disassembly of MSI products.



Chemical Substances Information

In compliance with chemical substances regulations, such as the EU REACH Regulation (Regulation EC No. 1907/2006 of the European Parliament and the Council), MSI provides the information of chemical substances in products at:

http://www.msi.com/html/popup/csr/evmtrpt_pcm.html

Battery Information



European Union:

Batteries, battery packs, and accumulators should not be disposed of as unsorted household waste. Please use the public collection system to return, recycle, or treat them in compliance with the local regulations.



Taiwan:

For better environmental protection, waste batteries should be collected separately for recycling or special disposal.

廢電池請回收

California, USA:

The button cell battery may contain perchlorate material and requires special handling when recycled or disposed of in California.

For further information please visit:

<http://www.dtsc.ca.gov/hazardouswaste/perchlorate/>

Danger of explosion if battery is incorrectly replaced. Replace only with the same or equivalent type recommended by the manufacturer.

Safety Instructions



- ☐ Read the safety instructions carefully and thoroughly.
- ☐ All cautions and warnings on the equipment or user's manual should be noted.



Keep the User's Guide that comes with the package for future reference.



Keep this equipment away from humidity and high temperature.



Lay this equipment on a reliable flat surface before setting it up.

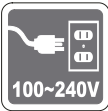

- ☐ Make sure that the power voltage is within its safety range and has been adjusted properly to the value of 100~240V before connecting the equipment to the power outlet. Do not disable the protective earth pin from the plug. The equipment must be connected to an earthed mains socket-outlet.
- ☐ Always unplug the AC power cord before installing any add-on card or module to the equipment.
- ☐ Always disconnect the AC power cord or switch the wall socket off if the equipment would be left unused for a certain time to achieve zero energy consumption.



The ventilator on the enclosure is used for air convection and to prevent the equipment from overheating. Do not cover the ventilator.



Do not leave the equipment in an unconditioned environment with a storage temperature above 60°C (140°F) or below 0°C (32°F), which may damage the equipment.

NOTE: The maximum operating temperature is around 40°C.



Never pour any liquid into the opening that could damage or cause electrical shock.



Place the power cord in a way that people are unlikely to step on it. Do not place anything on the power cord.



- ☑ When installing the coaxial cable to the TV Tuner, it is necessary to ensure that the metal shield is reliably connected to protective earthing system of the building.
- ☑ Cable distribution system should be grounded (earthed) in accordance with ANSI/NFPA 70, the National Electrical Code (NEC), in particular Section 820.93, Grounding of Outer Conductive Shield of a Coaxial Cable.



Always keep the strong magnetic or electrical objects away from the equipment.



If any of the following situations arises, get the equipment checked by service personnel:

- ☑ The power cord or plug is damaged.
- ☑ Liquid has penetrated into the equipment.
- ☑ The equipment has been exposed to moisture.
- ☑ The equipment does not work well or you can not get it work according to user's manual.
- ☑ The equipment has dropped and damaged.
- ☑ The equipment has obvious sign of breakage.

1. The optical storage devices are classified as CLASS 1 LASER PRODUCT. Use of controls or adjustments or performance of procedures other than those specified is prohibited.
2. Do not touch the lens inside the drive.

CE Conformity

Hereby, Micro-Star International CO., LTD declares that this device is in compliance with the essential safety requirements and other relevant provisions set out in the European Directive.



FCC-B Radio Frequency Interference Statement

This equipment has been tested and found to comply with the limits for a Class B digital device, pursuant to Part 15 of the FCC Rules. These limits are designed to provide reasonable protection against harmful interference in a residential installation. This equipment generates, uses and can radiate radio frequency energy and, if not installed and used in accordance with the instruction manual, may cause harmful interference to radio communications. However, there is no guarantee that interference will not occur in a particular installation. If this equipment does cause harmful interference to radio or television reception, which can be determined by turning the equipment off and on, the user is encouraged to try to correct the interference by one or more of the measures listed below:



- Reorient or relocate the receiving antenna.
- Increase the separation between the equipment and receiver.
- Connect the equipment into an outlet on a circuit different from that to which the receiver is connected.
- Consult the dealer or an experienced radio/television technician for help.

Notice 1

The changes or modifications not expressly approved by the party responsible for compliance could void the user's authority to operate the equipment.

Notice 2

Shielded interface cables and AC power cord, if any, must be used in order to comply with the emission limits.

VOIR LA NOTICE D'INSTALLATION AVANT DE RACCORDER AU RESEAU.

This device complies with Part 15 of the FCC Rules. Operation is subject to the following two conditions:

1. this device may not cause harmful interference, and
2. this device must accept any interference received, including interference that may cause undesired operation.

WEEE Statement

Under the European Union ("EU") Directive on Waste Electrical and Electronic Equipment, Directive 2002/96/EC, which takes effect on August 13, 2005, products of "electrical and electronic equipment" cannot be discarded as municipal waste anymore and manufacturers of covered electronic equipment will be obligated to take back such products at the end of their useful life.



Chapter 1

Overview

This system is integrated in design, selecting a stylish appearance with a mirror screen, which displays the simplicity of modern individualism and the comfort of home. With a touchscreen display, flawless audio/video capabilities, and intuitive user interface, it blends technology with life, making computers easier and more fun to use — suitable for the whole family.

Packing Contents

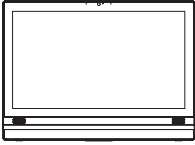

All-in-One PC

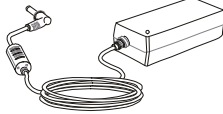

AC/DC Adapter

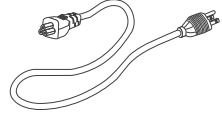

AC Power Cord



Display Wiper



Driver/ Utility Disk

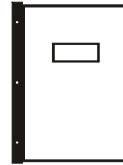

User Manual
& Quick Guide

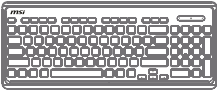

Keyboard (Optional)



Mouse (Optional)

* Please contact us immediately if any of the items is damaged or missing.

* The illustrations are for reference only and your packing contents may slightly vary depending on the model you purchased.

System Overview

► Front View

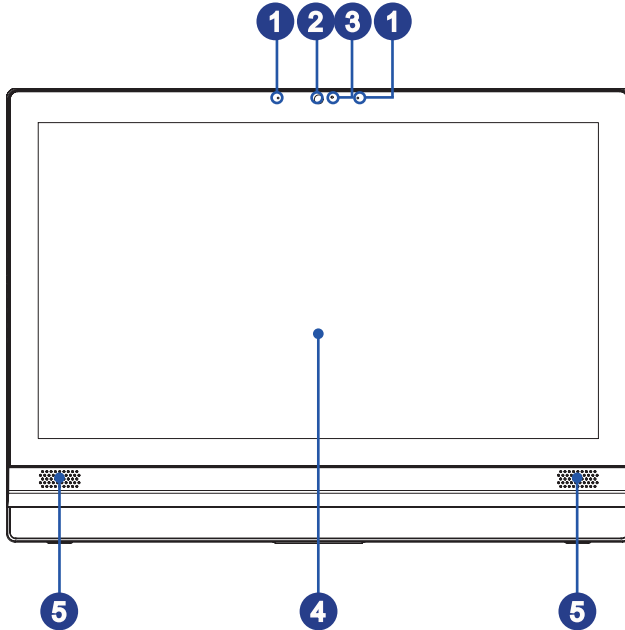
**1****Microphone**

The built-in microphone can be used for video chatting online.

2**Webcam**

The built-in webcam with the microphone can be used for picture taking, video recording, online conferencing and any other interactive applications.

3**LED Indicator (Optional)**

The LED indicator indicates when it is recording. The LED indicator should be on when device is capturing video and off when the device is not capturing video.

4**Display**

The 23.6-inch Full HD display is with an optimal resolution of 1920 X 1080 pixels and standard proportion of 16:9 widescreen.

5**Stereo Speakers**

The built-in stereo speakers deliver high quality sound blaster with stereo system.

► Rear View

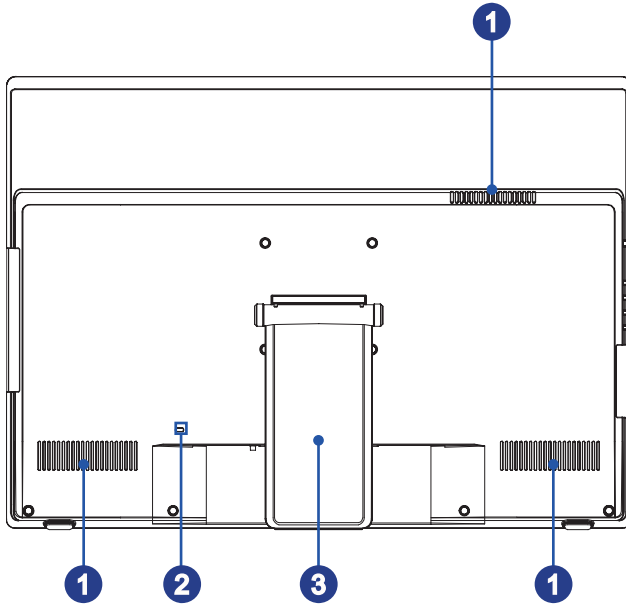

1

Ventilator

The ventilator on the enclosure is used for air convection and to prevent the equipment from overheating. Do not cover the ventilator.

2

Kensington Lock Port

This AIO PC provides a Kensington lock port, which allows users to secure the AIO PC in place with a key or some mechanical PIN device and attached through a rubberised metal cable. The end of the cable has a small loop which allows the whole cable to be looped around a permanent object, such as a heavy table or other similar equipment, thus securing the AIO PC in place.

3

Stand

Use this stand to position your system on a flat and stable surface.

► Side View

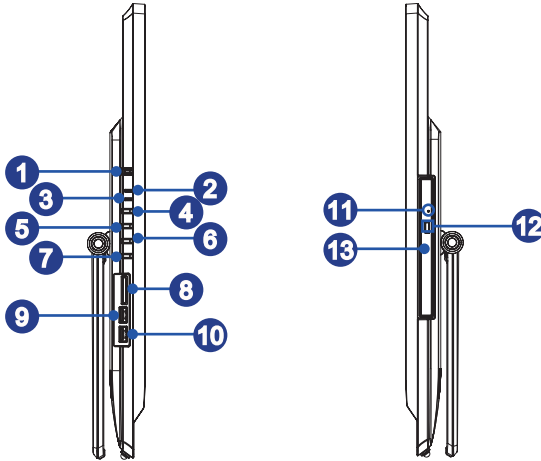

1 System Power Button/ LED

Press the system power button to turn the system on or off.

The power LED glows when the system is turned on and goes off when the system is shut down. In terms of power saving, the LED blinks in S3 (Suspend to RAM) mode and goes off in S4 (Suspend to Disk) mode.

2 Monitor Power LED

The power LED glows when the monitor is turned on and goes off when the monitor is shut down.

3 Hard Disk Drive LED

This indicator shows the activity status of the HDD. It flashes when the system is accessing data on the HDD and remains off when no disk activity is detected.

4 Monitor Power Button

Press the monitor power button to turn the monitor on or off.

5 Menu Button

Press this button to view and switch between the brightness and volume menus.

6 Brightness/ Volume Up Button

Press this button to tune the brightness/ volume up.

7 **Brightness/ Volume Down Button**

Press this button to tune the brightness/ volume down.

8 **Card Reader Drive**

The built-in card reader may support various types of memory cards.

9 **USB 2.0 Port (with MSI Super Charger Technology) (Optional)**

The USB (Universal Serial Bus) port is for attaching USB devices such as keyboard, mouse, or other USB-compatible devices. It supports up to 480Mbit/s (Hi-Speed) data transfer rate.

With MSI Super Charger Technology, not only does it function as normal USB 2.0 port, but it also enables users to charge USB devices even when the system is turned off. Users will no longer need to power on the system just to charge USB devices. Better yet, it can reduce the charge time up to 40%, making life more efficient than ever.

10 **USB 2.0 Port**

The USB (Universal Serial Bus) port is for attaching USB devices such as keyboard, mouse, or other USB-compatible devices. It supports up to 480Mbit/s (Hi-Speed) data transfer rate.

11 **Eject Hole**

Insert a thin, straight object (such as a paper clip) into the eject hole to open the optical disk drive manually if the eject button does not work.

12 **Eject Button**

Press the eject button to open the optical disk drive.

13 **Optical Disk Drive**

A DVD Super-Multi drive is integrated for your home entertainment (Blu-ray is optional).

► Top and Bottom View

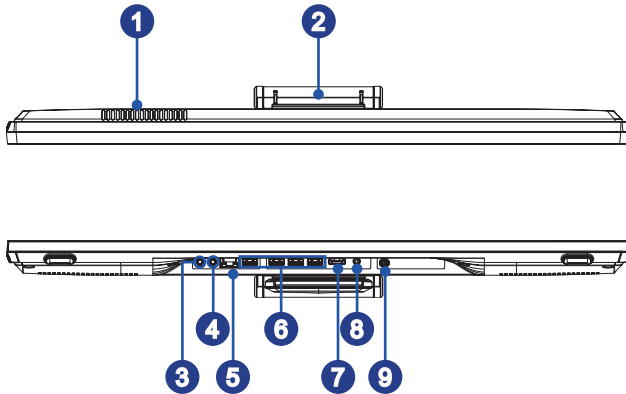
**1****Ventilator**

The ventilator on the enclosure is used for air convection and to prevent the equipment from overheating. Do not cover the ventilator.

2**Stand**

Use this stand to position your system on a flat and stable surface.

3**Line-Out Jack**

This connector is provided for headphones or speakers.

4**Microphone Jack**

This connector is provided for microphones.

5

RJ-45 LAN Jack

The standard RJ-45 LAN jack is provided for connection to the Local Area Network (LAN). You can connect a network cable to it.

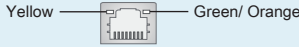

LED	Color	LED State	Condition
Left	Yellow	Off	LAN link is not established.
		On (steady state)	LAN link is established.
		On (brighter & pulsing)	The computer is communicating with another computer on the LAN.
Right	Green	Off	10 Mbit/sec data rate is selected.
		On	100 Mbit/sec data rate is selected.
	Orange	On	1000 Mbit/sec data rate is selected.

6

USB 3.0 Port (Optional)

The USB 3.0 port is backward-compatible with USB 2.0 devices. It supports up to 5Gbit/s (SuperSpeed) data transfer rate.

7

HDMI-Out Port (Optional)



The High-Definition Multimedia Interface (HDMI) is an all-digital audio/video interface capable of transmitting uncompressed streams. HDMI supports all TV format, including standard, enhanced, or high-definition video, plus multi-channel digital audio on a single cable.

** Please refer to the printed icon on the chassis for the exact position of HDMI-In Port and HDMI-Out Port.*

8

Power Jack

The AC/DC adapter converts AC power to DC power for this jack. Power supplied through this jack supplies power to the PC. To prevent damage to the PC, always use the supplied power adapter.

9

TV Tuner Antenna Connector (Optional)

This connector is provided for digital TV tuner antenna.

Important

1. We suggest that you connect the AC/DC adapter to your AIO PC first and then connect the AC power cord to the socket-outlet for safety concerns.
2. High-speed devices are recommended for USB 3.0 ports whereas low-speed devices, such as mouse or keyboard, are suggested to be plugged into the USB 2.0 ports on the rear panel.

Component Replacement & Upgrade

Please note that certain components preinstalled in the product may be upgradable or replaceable by user's request depending on the models users purchased.

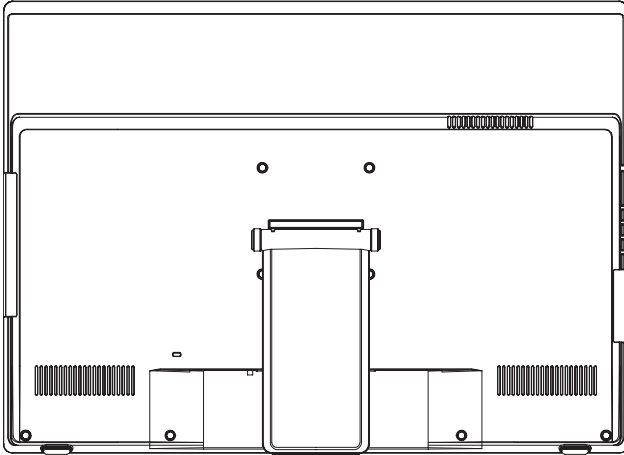

For any further information on the product users purchased, please contact the local dealer. Do not attempt to upgrade or replace any component of the product if you are not an authorized dealer or service center, since it may cause the warranty void. It is strongly recommended that you contact the authorized dealer or service center for any upgrade or replace service.

Chapter 2

Getting Started

This chapter provides you with the information on hardware setup procedures. While connecting peripheral devices, be careful in holding the devices and use a grounded wrist strap to avoid static electricity.

Safety & Comfort Tips

The AIO PC is a portable platform that allows you to work anywhere. However, choosing a good workspace is important if you have to work with your PC for a long period of time.

1. Your work area should have enough illumination.
2. Choose the proper desk and chair and adjust their height to fit your posture when operating.
3. When sitting on the chair, sit straight and keep a good posture. Adjust the chair's back (if available) to support your back comfortably.
4. Place your feet flat and naturally on the floor, so that your knees and elbows have the proper position (about 90-degree) when operating.
5. Put your hands on the desk naturally to support your wrists.
6. Adjust the angle/position of the AIO PC to have an optimal view.
7. Avoid using your PC in a place where discomfort may occur (such as on the bed).
8. The AIO PC is an electrical device. Please treat it with great care to avoid personal injury.

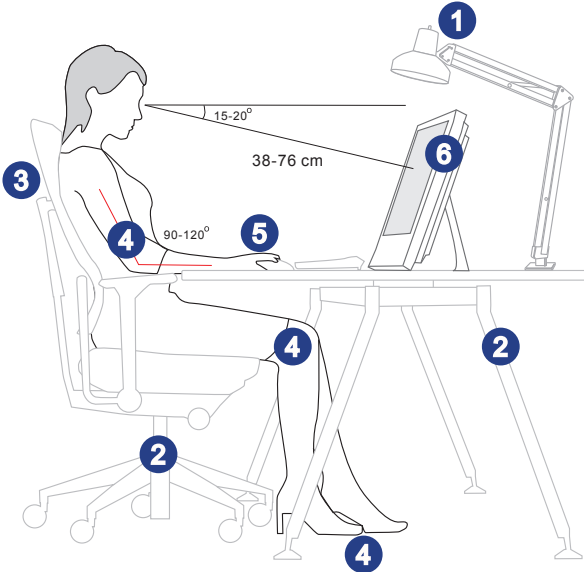

Hardware Setup

► Positioning Your System

1. Place your system on a flat and steady surface such as a table or desk.
2. Pull the stand open and tilt the monitor. To stabilize the system, make sure that the mark on its hinge aligns to the edge of the hinge cover. Proper positioning helps to reduce your eye strain & muscle fatigue as well.

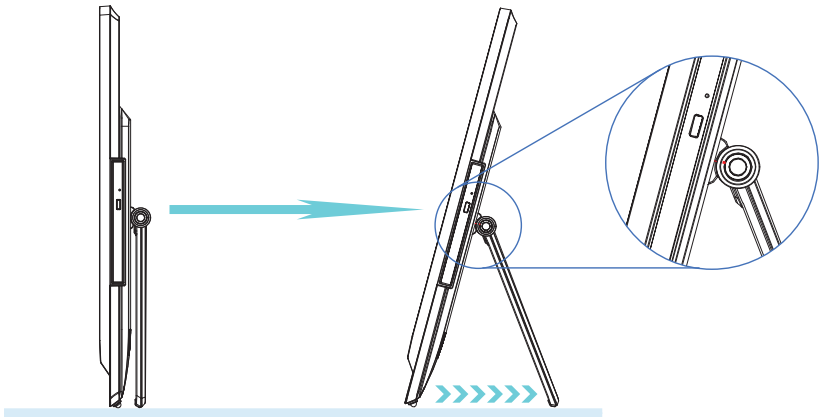

► Connecting the AC Power

1. Assemble the AC/DC adapter and the AC power cord.
2. Plug the DC end of the adapter to the AIO PC.
3. Plug the male end of the AC power cord to the electrical outlet.

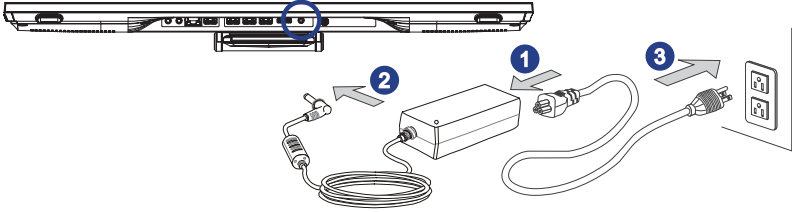

Important

We suggest that you connect the AC/DC adapter to your AIO PC first and then connect the AC power cord to the socket-outlet for safety concerns.

► Powering on the System

Press the power button to power on the system.

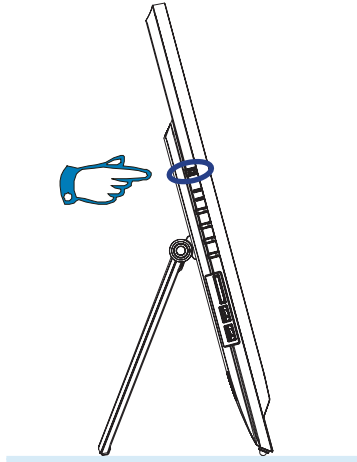

Chapter 3

System Operations

This chapter provides you with essential information on system operations.

Important

All information is subject to change without prior notice.

Power Management

Power management of personal computers (PCs) and monitors has the potential to save significant amounts of electricity as well as deliver environmental benefits.

To be energy efficient, turn off your display or set your PC to sleep mode after a period of user inactivity.

► Power Management in Windows 7

- [Power Options] in Windows OS allow you to control the power management features of your display, hard drive, and battery. Go to [Start] > [Control Panel] > [System and Security].

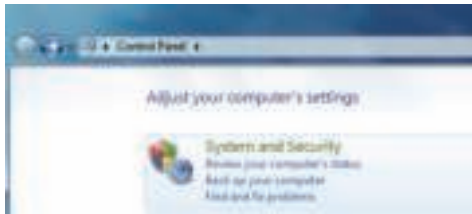

Then click on the [Power Options] link.

Select a power plan that suits your personal needs. You may also fine-tune the settings by clicking [Change plan settings].

- The Shut Down Computer menu presents the options of Sleep (S3/S4) & Shut Down (S5) for rapid and easy management of your system power.

► Power Management in Windows 8.x

- [Power Options] in Windows OS allow you to control the power management features of your display, hard drive, and battery. Go to [Start] > [Control Panel] > [System and Security].



Then click on the [Power Options] link.

Select a power plan that suits your personal needs. You may also fine-tune the settings by clicking [Change plan settings].

- The Shut Down Computer menu presents the options of Sleep (S3/S4) & Shut Down (S5) for rapid and easy management of your system power.

➤ Power Management through ENERGY STAR qualified monitors (Optional)

The power management feature allows the computer to initiate a low-power or "Sleep" mode after a period of user inactivity. When used with an external ENERGY STAR qualified monitor, this feature also supports similar power management features of the monitor.

To take advantage of these potential energy savings, the power management feature has been preset to behave in the following ways when the system is operating on AC power:

- Turn off the display after 15 minutes
- Initiate Sleep after 30 minutes



➤ Waking the System Up

The computer shall be able to wake up from power saving mode in response to a command from any of the following:

- the power button,
- the network (Wake On LAN),
- the mouse,
- the keyboard.



Energy Saving Tips:

- Turn off the monitor by pressing the LCD power button after a period of user inactivity.
- Tune the settings in Power Options under Windows OS to optimize your PC's power management.
- Install power saving software to manage your PC's energy consumption.
- Always disconnect the AC power cord or switch the wall socket off if your PC would be left unused for a certain time to achieve zero energy consumption.

Network Connection (Windows 7)

➤ Wired LAN

1. Go to [Start] > [Control Panel].
2. Select [Connect to the Internet] under [Network and Internet].

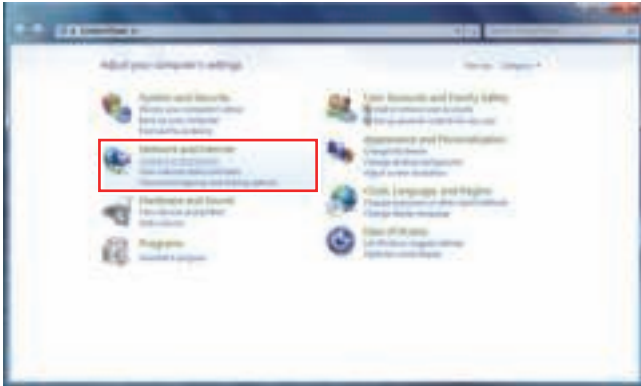

3. Select [Broadband (PPPoE)] to connect using DSL or cable that requires a user name and password.

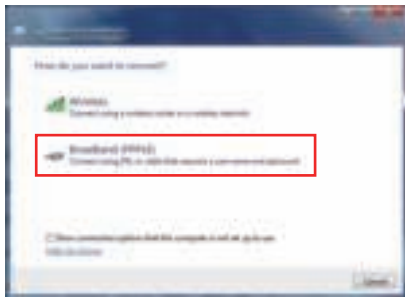

4. Type the information from your Internet Service Provider (ISP) and click [Connect] to establish your LAN connection.

► Wireless LAN

1. Go to [Start] > [Control Panel].
2. Select [Connect to the Internet] under [Network and Internet].

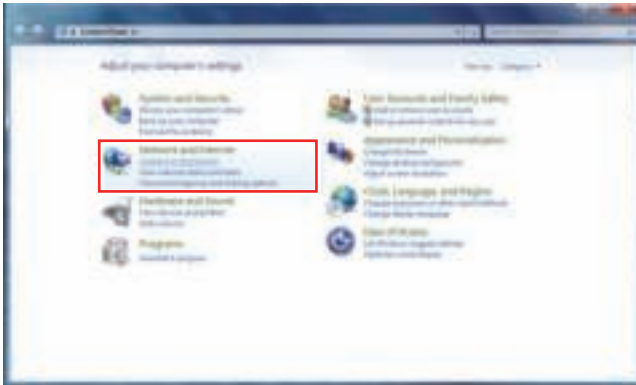

3. Select [Wireless] to connect using a wireless router or a wireless network.

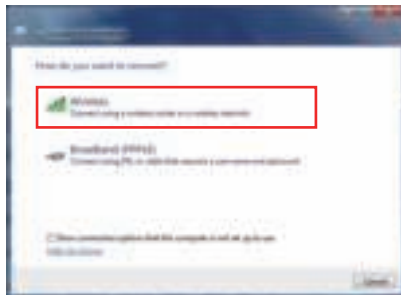

4. A list of available WLAN connections pops up. Choose a connection from the list or click [Open Network and Sharing Center] to establish a new connection.

5. To establish a new WLAN connection, select [Set up a new connection or network] in [Network and Sharing Center].



6. Followingly, choose [Manually connect to a wireless network] and click [Next] to continue.

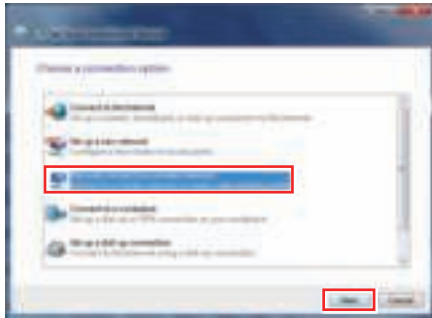

7. Enter information for the wireless network you intend to add and click [Next] to proceed.
8. A new WLAN connection has been made. Click [Close] to exit or select [Change connection settings] to modify the WLAN settings.

Network Connection (Windows 8.x)

► Wired LAN

1. Go to [Start] > [Control Panel].
2. Select [View network status and tasks] under [Network and Internet].

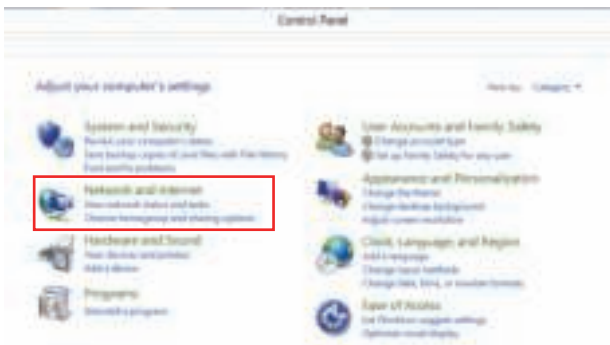

3. To establish a new connection, select [Network and Sharing Center].
4. Select [Set up a new connection or network].



5. Choose [Connect to the Internet].
6. Select [Broadband (PPPoE)] to connect using DSL or cable that requires a user name and password.

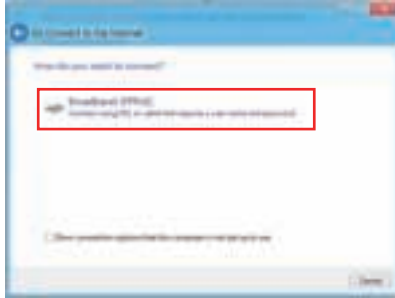

7. Type the information from your Internet Service Provider (ISP) and click [Connect] to establish your LAN connection.

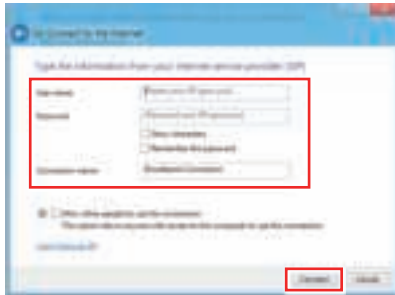

► Wireless LAN

1. Select [Settings]  on Desktop, locate a wireless icon with available network.
2. A list of available WLAN connections pops up. Choose a connection from the list.
3. To establish a new connection, select [Network and Sharing Center] under [Network and Internet] in [Control Panel].

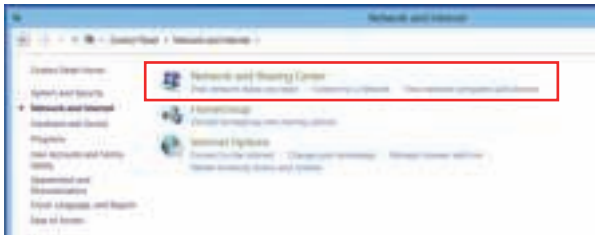

4. Select [Set up a new connection or network].
5. Followingly, choose [Manually connect to a wireless network] and click [Next] to continue.
6. Enter information for the wireless network you intend to add and click [Next] to proceed.

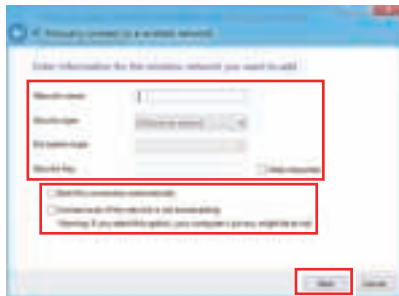

7. A new WLAN connection has been made. Click [Close] to exit or select [Change connection settings] to modify the WLAN settings.

System Recovery (Windows 7)

Important

The Recovery Tool is only available on systems bundled with Windows OS and MSI utilities by default.

The purposes for using the Recovery Tool may include:

- Restore the system back to the initial status of original manufacturer's default settings.
- When some errors have occurred to the operating system in use.
- When the operating system is affected by virus and is not able to work normally.
- When you want to install the OS with other built-in languages.

Before using the Recovery Tool, please back up the important data saved on your system drive to other storage devices.

If the following solution fails to recover your system, please contact the authorized local distributor or service center for further assistance.

► **Recovering the System with the F3 Hotkey**

If the system encounters non-recoverable problems, it is always recommended that you try the F3 hotkey to recover your system with the recovery partition of the hard disk drive first.

Follow the instructions below to continue:

1. Restart the system.
2. Press the F3 hotkey on the keyboard when the following image appears.



3. Enter the Recovery Tool. This tool contains three features: Backup System, Restore System and Recover to factory default.



► System Backup

It is highly recommended that users back up the system as the solution in the event of a catastrophic disk failure or other accidents.

Follow the instructions below to continue:

1. Select [Backup System] to enter. Alternatively, select [X] or press [Esc] on the keyboard to exit.



2. Select [BACKUP] to start the system backup immediately.

▣ The Initial Backup

The initial backup may take a while. Please let it complete without interruption.



▣ Subsequent Backups

Subsequent backups will replace the previous backup files.



- The system backup is in progress. Please note that it may take a while. Do not switch off the power, or it may cause unknown damage to the system.



- Alternatively, select [CANCEL] to stop the system backup immediately. Please do not switch off the power while the system backup cancellation is in progress.



5. The following message indicates a successful system backup. Press [OK] to finish.

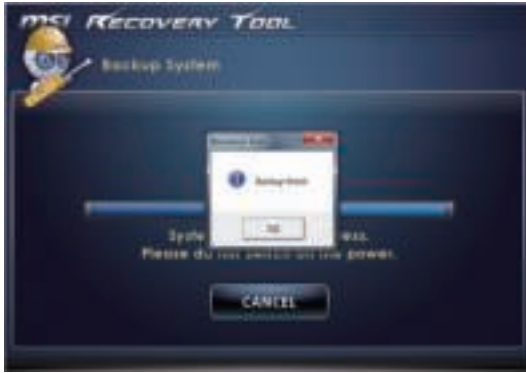

► System Restore

This tool helps to return the system to a previous state with the backup files that users created and saved in the hard disk drive beforehand. If no backup files are available, the system will be restored to the default setup.

Follow the instructions below to continue:

1. Select [Restore System] to enter. Alternatively, select [X] or press [Esc] on the keyboard to exit.



2. Select [OK] or [NEXT] so that the system can recover to the previous backup or default setup. Alternatively, select [CANCEL] to stop the system restore immediately.

▣ **With backup files: restoring the system to the previous backup**



▣ **Without backup files: restoring the system to the default setup**



3. The system restore is in progress. Please note that it may take a while. Do not switch off the power, or it may cause unknown damage to the system.



4. The following message indicates a successful system restore. Press [OK] to finish. Restart the system and access the Windows operating system as usual. If the restore process fails or is interrupted, please start the whole procedure all over again.



► System Recovery

This tool helps to recover the system back to factory default settings. All data on the HDD will be erased while all settings will be restored to factory default.

Follow the instructions below to continue:

1. Select [Recover to factory default] to enter. Alternatively, select [X] or press [Esc] on the keyboard to exit.



2. The system will be recovered to factory settings. All data will be gone. Make sure all important data have been backed up. Select [NEXT] to continue. Alternatively, select [CANCEL] to stop.



3. Please select [OK] so that the system can recover its default setup.



4. The system recovery is in progress. Please note that it may take a while. Do not switch off the power, or it may cause unknown damage to the system.



- The following message indicates a successful system recovery. Press [OK] to finish. Restart the system and access the Windows operating system as usual. If the recovery process fails or is interrupted, please start the whole procedure all over again.



System Recovery (Windows 8.x)

Important

The System Recovery Function is only available on systems bundled with Windows OS and MSI utilities by default.

The purposes for using the System Recovery Function may include:

- Restore the system back to the initial status of original manufacturer's default settings.
- When some errors have occurred to the operating system in use.
- When the operating system is affected by virus and is not able to work normally.
- When you want to install the OS with other built-in languages.

Before using the System Recovery Function, please backup the important data saved on your system drive to other storage devices.

If the following solution fails to recover your system, please contact the authorized local distributor or service center for further assistance.

► **Creating System Recovery Discs**

For the first-time use, it is highly recommended that users create system recovery discs as the backup solution in the event of a catastrophic disk failure or other accidents.

Double-click the "BurnRecovery"  icon on the desktop to launch the Recovery Disc Creation Tool. Follow the on-screen instructions to create all recovery discs.

► Recovering the System with the Recovery Discs

This section is meant for users to restore your system with the recovery discs that you created beforehand.

Follow the instructions below to continue:

1. Insert the recovery disc into the optical disc drive.
2. Click [Settings]  on desktop, then select [Change PC settings] > [Update and recovery].

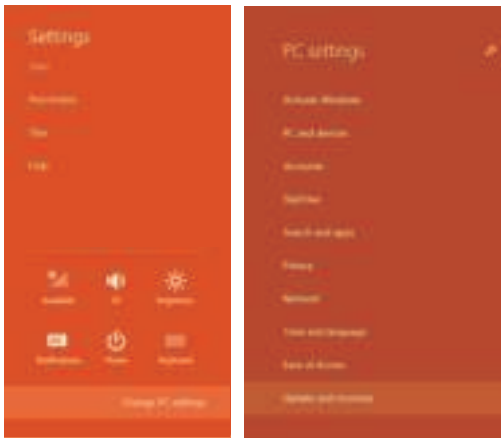

3. Click [Recovery] > [Advanced startup], and select [Restart now] to restart the system.



4. After booting up, the following screen will pop up, select [Continue].

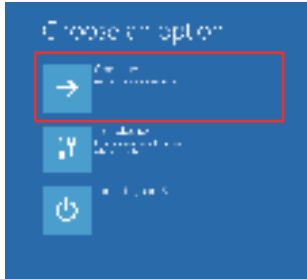

5. Press any key to reconfirm the selection when the following message appears.



6. The Windows OS starts loading files.

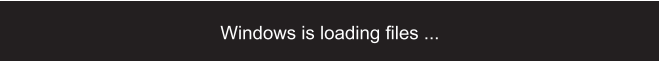

7. The system recovery menu pops up. [Hard Disk Recovery] will format the whole HDD. All data on the HDD will be erased while all settings will be restored to manufacturer default. Select [Hard Disk Recovery] only when your HDD is infected with fatal viruses and no solution can be found except a clear cleanup of the HDD.

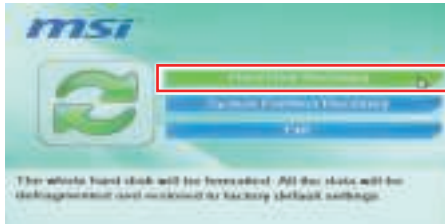

[System Partition Recovery] will format the C drive only. Only the C drive will be restored to manufacturer default. Other drives will not be affected. It is highly recommended that users select [System Partition Recovery] to restore the system.

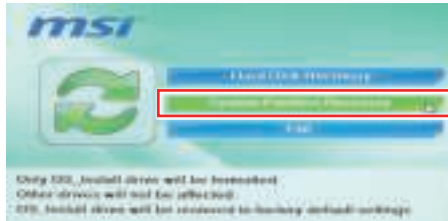

8. The system recovery will format your HDD partition. Make sure that the important data have been backed up. Click [YES] to continue; click [NO] to stop the system recovery.

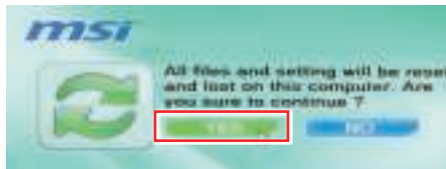

Click [YES] again to reconfirm; click [NO] to stop the system recovery.

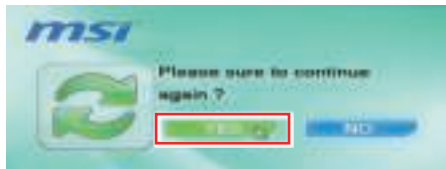

9. DO NOT turn off the system power while performing the system recovery function, or it may cause unknown damage to the system.



10. The following message indicates successful system recovery. Press [OK] to restart the system and access the Windows operating system as usual.



11. If the recovery process is interrupted or failed, please repeat the recovery procedures from the beginning.

► Recovery from the Operating System

▣ Refresh PC

The Refresh PC utility checks whether the system files, Windows registry, and other important system components are working fine or not; on finding issues with Windows files, it will attempt to repair your PC. If your PC isn't running well, you can refresh it without losing your personal files.

1. Click [Settings]  on desktop, then select [Change PC settings] > [Update and recovery].
2. Click [Recovery] > [Refresh your PC without affecting your files], and select [Get started].



3. It will show the changes which will be made during the process, click [Next] to continue.

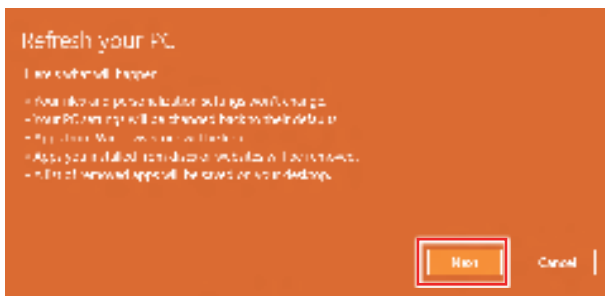

4. A message indicates that your PC is ready to be refreshed, click [Refresh] to start. This might take a while.

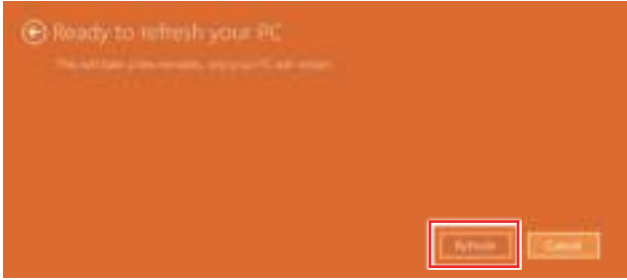

5. After the refresh process ends, you will be back to Windows Start Screen where you can find all default Windows utilities and widgets.



Reset PC

The Reset utility will bring the system back to original factory settings.

1. Click [Settings]  on desktop, then select [Change PC settings] > [Update and recovery].
2. Click [Recovery] > [Remove everything and reinstall Windows], and select [Get started].

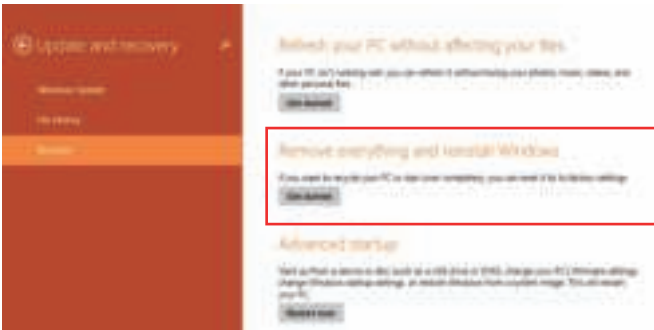

3. It will show the changes to be made during the process, click [Next] to continue.

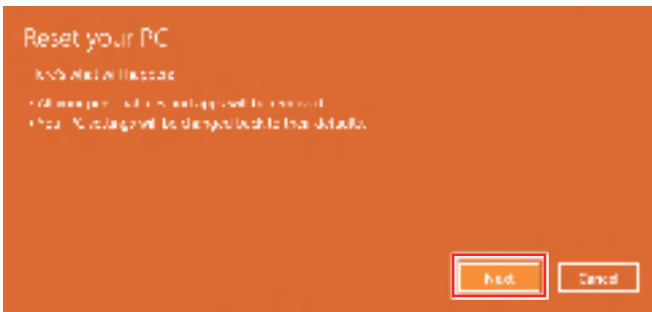

4. You will be prompted to choose which drive you want to clean for a hard disk with multiple partitions.

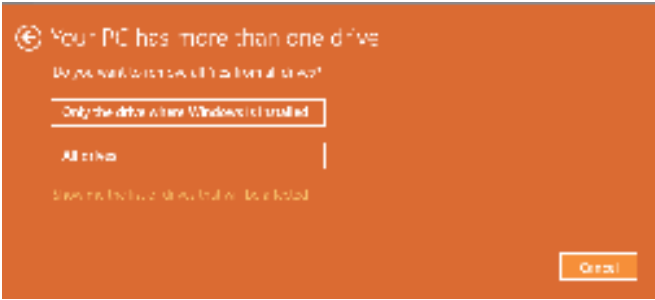

5. Now, select either to remove files or to fully clean drives according to your needs.

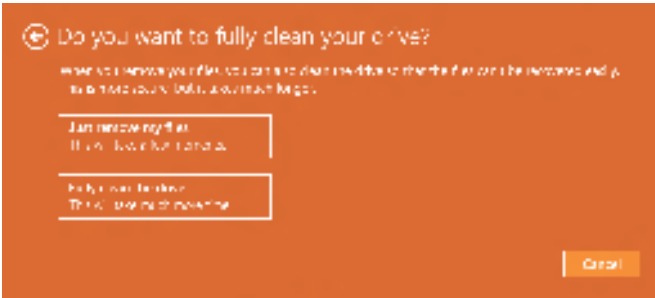

6. It is now ready to reset your PC, click [Reset] and follow the on-screen instructions to restart your PC.

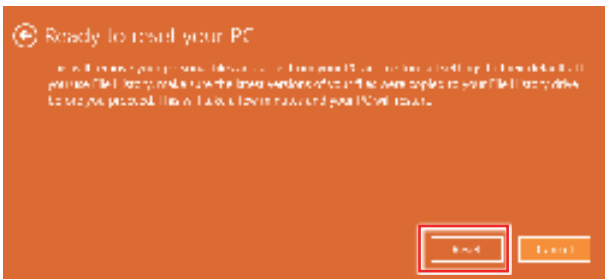



Appendix A

Troubleshooting

My system does not start.

1. Check if the system is connected to an electrical outlet and it is turned on.
2. Check if the power cord and all cables are connected firmly.

When I turn on my computer, the message “Operating System not found” appears or Windows does not start.

1. Check if there is a non-bootable CD/ DVD inside the optical disk drive. If so, remove the CD/ DVD then restart the computer.
2. Check Boot Device Priority settings in the BIOS Setup.

The system can not be shut down.

It is best to shut down your computer using the Shut Down icon in the operating system. Using other methods, including those listed below, may result in data failure. If the Shut Down procedure does not work, choose one of the following steps:

1. Press Ctrl+Alt+Del keys, then choose Shut Down.
2. Press and hold the power button till the system is off.
3. Unplug the power cable from the system.

My microphone does not work.

1. For built-in microphone, please go to Start > Control Panel > Sounds and Audio Devices > Audio to check if it is muted.
2. If you are using an external microphone, check that the microphone is plugged into the Microphone jack.

The Internet connection has problems.

1. If you are having a problem connecting to your Internet Service Provider (ISP), check if the ISP is experiencing technical problems.
2. Check the Network settings and connection and make sure the system is properly configured to Internet access.
3. The wireless LAN data transfer speed is affected by distance and obstructions between devices and access points. To maximize the data transfer speed, choose the access point closest to your system.

System speakers do not work.

1. Check the master volume setting in the Audio Mixer.
2. If you are using an application that has its own volume control, check if the volume is muted.
3. If you have connected an audio cable to the Headphone jack, disconnect it.
4. If the system has OSD function, please adjust the volume of OSD.

I cannot play a CD/ DVD with the DVD-ROM of the system.

1. Make sure the label of the CD/ DVD is facing up.
2. If the CD/ DVD requires software, make sure the software is well installed according to the program instructions.
3. If a region code warning appears when you play the DVD, the problem could be that the DVD is incompatible with the DVD-ROM in your system. The region code is listed on the disc packaging.
4. If you see video but cannot hear audio, check the media player. Also, make sure the speakers and the master volume setting in the Audio Mixer are not muted.
5. Check if the drivers are installed properly. Click Start > Control Panel > System > Device Manager.
6. A dirty or scratched disc may cause the computer to hang when it is trying to read the disc. If necessary, reboot the computer, remove the disc, and check if it is dirty or scratched.
7. Please use DVD player software like PowerDVD or WinDVD to play DVD video.

My DVD-ROM drive tray does not open.

1. Make sure the computer is turned on.
2. Press the Eject button on the DVD-ROM drive.
3. If the Eject button does not work, open the tray by inserting a sharp, pointed object into the hole next to the Eject button.

System monitor does not display anything.

1. Check if the system is connected to an electrical outlet and it is turned on.
2. The system may be in Standby mode. Press any key to activate the Display.