

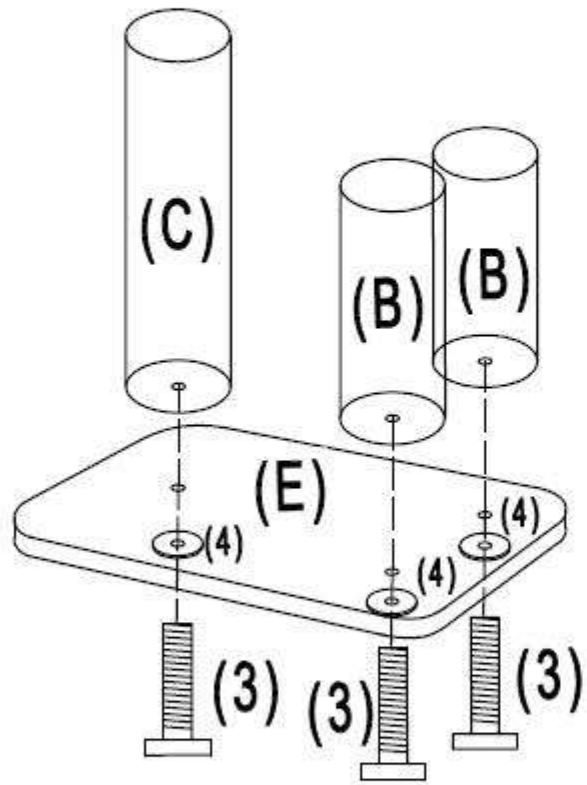

RHRQUALITY

Bouwtekening Krabpaal Devon Rex

1





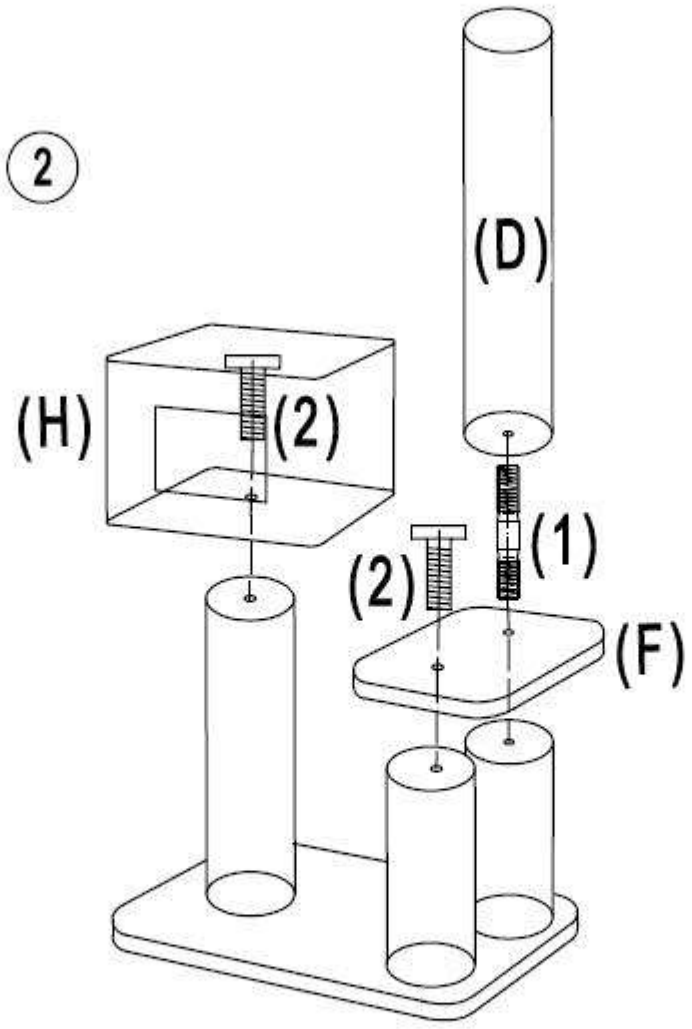

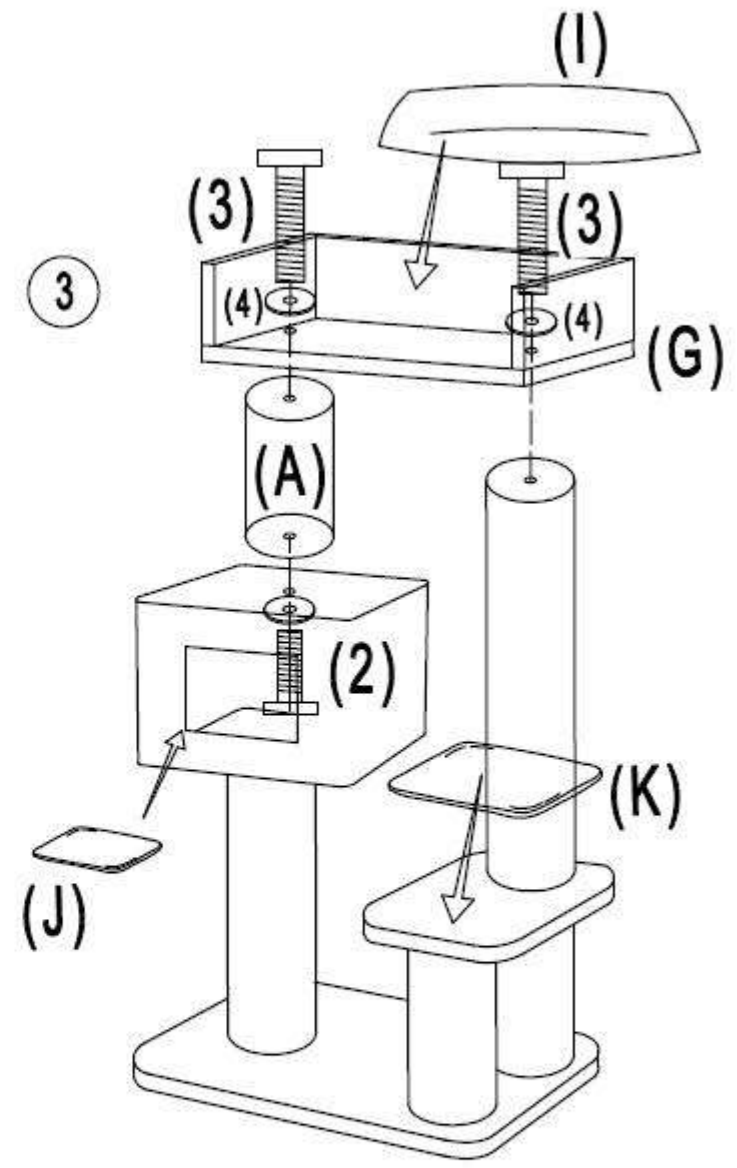

2







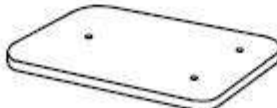

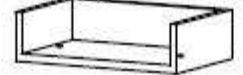

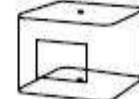
3

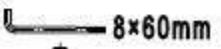

- 1x  $\varnothing 15 \times 20\text{cm}$ (A)
- 2x  $\varnothing 15 \times 30\text{cm}$ (B)
- 1x  $\varnothing 15 \times 52\text{cm}$ (C)
- 1x  $\varnothing 15 \times 70\text{cm}$ (D)

- 1x  $70 \times 50 \times 4\text{cm}$ (E)
- 1x  $50 \times 35\text{cm}$ (F)
- 1x  $60 \times 43 \times 15\text{cm}$ (G)

- 1x  $40 \times 40 \times 30\text{cm}$ (H)
- 1x  (I)
- 1x  (J)
- 1x  (K)

- 1x  $8 \times 60\text{mm}$
- 1x  $\varnothing 8 \times 80\text{mm}$ (1)
- 3x  $\varnothing 8 \times 40\text{mm}$ (2)
- (5+1)x  $\varnothing 8 \times 60\text{mm}$ (3)
- 6x  (4)