



**SHENZHEN YARUI TESTING CO., LTD.**

No.1107-1109, Weidonglong Technology Building, Meilong Avenue, Qinghu Longhua District ,  
Shenzhen 518109, Guangdong, China

Tel : +86-755-27912080 Fax: +86-755-27916936

# EMC TEST REPORT

**Product name** ..... : Cylindrical Timing Night Light

**Trademark** ..... : HBK

**Model No.** ..... : HBKYZD-01

**Test Standards** ..... : **EN IEC 55015:2019+A11:2020**  
**EN 61547:2009**  
**EN IEC 61000-3-2:2019/A1:2021**  
**EN 61000-3-3: 2013+A1:2019**

**Applicant** ..... : Xiamen Black And White Guest Culture Technology

**Address of applicant** ..... : 608 B, 6th Floor, North District, Yihua Center, No.1 Qishan Road,  
Huli District, Xiamen City, Fujian Province, China

**Date of Test** ..... : Jun.08, 2021 - Jun.15, 2021

**Date of issue** ..... : Jun.16, 2021

**Report No.** ..... : YRT202106225E

|                          |        |
|--------------------------|--------|
| <b>Test result</b> ..... | Pass * |
|--------------------------|--------|

\* In the configuration tested, the EUT complied with the standards specified above



The CE mark as shown above can be used, under the responsibility of the manufacturer, after completion of an EC Declaration of Conformity and compliance with all relevant EC Directives. The protection requirements with respect to electromagnetic compatibility contained in Directive 2014/30/EU are considered.

# TABLE OF CONTENT

|  | Page      |
|--|-----------|
| Test Report Declaration  |           |
| <b>1. GENERAL INFORMATION</b> .....                            | <b>5</b>  |
| 1.1. Description of Device (EUT).....                          | 5         |
| 1.2. Tested System Details.....                                | 5         |
| 1.3. Test Uncertainty.....                                     | 5         |
| 1.4. Test Facility.....  | 6         |
| <b>2. TEST INSTRUMENT USED</b> .....                           | <b>7</b>  |
| <b>3. CONDUCTED EMISSION AT THE MAINS TERMINALS TEST</b> ..... | <b>10</b> |
| 3.1. Block Diagram Of Test Setup.....                          | 10        |
| 3.2. Test Standard.....  | 10        |
| 3.3. Power Line Conducted Emission Limit.....                  | 10        |
| 3.4. EUT Configuration on Test.....                            | 10        |
| 3.5. Operating Condition of EUT.....                           | 10        |
| 3.6. Test Procedure.....                                       | 11        |
| 3.7. Test Result.....  | 11        |
| <b>4. MAGNETIC EMISSION TEST</b> .....                         | <b>12</b> |
| 4.1. Block Diagram Of Test Setup.....                          | 12        |
| 4.2. Test Standard.....  | 12        |
| 4.3. Power Line Conducted Emission Limit.....                  | 12        |
| 4.4. EUT Configuration on Test.....                            | 12        |
| 4.5. Operating Condition of EUT.....                           | 12        |
| 4.6. Test Procedure.....                                       | 13        |
| 4.7. Test Result.....  | 13        |
| <b>5. RADIATION EMISSION TEST</b> .....                        | <b>14</b> |
| 5.1. Block Diagram of Test Setup.....                          | 14        |
| 5.2. Test Standard.....  | 14        |
| 5.3. Radiation Limit.....                                      | 14        |
| 5.4. EUT Configuration on Test.....                            | 14        |
| 5.5. Operating Condition of EUT.....                           | 15        |
| 5.6. Test Procedure.....                                       | 15        |
| 5.7. Test Result.....  | 15        |
| <b>6. HARMONIC CURRENT EMISSION TEST</b> .....                 | <b>18</b> |
| 6.1. Block Diagram of Test Setup.....                          | 18        |
| 6.2. Test Standard.....  | 18        |
| 6.3. Operating Condition of EUT.....                           | 18        |
| 6.4. Test Procedure.....                                       | 18        |
| 6.5. Test Results.....   | 18        |
| <b>7. VOLTAGE FLUCTUATIONS &amp; FLICKER TEST</b> .....        | <b>19</b> |
| 7.1. Block Diagram of Test Setup.....                          | 19        |
| 7.2. Test Standard.....  | 19        |
| 7.3. Operating Condition of EUT.....                           | 19        |
| 7.4. Test Procedure.....                                       | 19        |
| 7.5. Test Results.....   | 19        |
| <b>8. ELECTROSTATIC DISCHARGE IMMUNITY TEST</b> .....          | <b>20</b> |
| 8.1. Block Diagram of Test Setup.....                          | 20        |
| 8.2. Test Standard.....  | 20        |
| 8.3. Severity Levels and Performance Criterion.....            | 20        |
| 8.4. EUT Configuration.....                                    | 21        |
| 8.5. Operating Condition of EUT.....                           | 22        |
| 8.6. Test Procedure.....                                       | 22        |

## SHENZHEN YARUI TESTING CO., LTD.

|            |  |           |
|------------|--|-----------|
| 8.7.       | Test Results .....   | 22        |
| <b>9.</b>  | <b>RF FIELD STRENGTH SUSCEPTIBILITY TEST .....</b>         | <b>24</b> |
| 9.1.       | Block Diagram of Test Setup .....                          | 24        |
| 9.2.       | Test Standard .....  | 24        |
| 9.3.       | Severity Levels and Performance Criterion .....            | 24        |
| 9.4.       | EUT Configuration on Test .....                            | 25        |
| 9.5.       | Operating Condition of EUT .....                           | 25        |
| 9.6.       | Test Procedure .....                                       | 26        |
| 9.7.       | Test Results .....   | 26        |
| <b>10.</b> | <b>ELECTRICAL FAST TRANSIENT/BURST IMMUNITY TEST .....</b> | <b>27</b> |
| 10.1.      | Block Diagram of EUT Test Setup .....                      | 27        |
| 10.2.      | Test Standard .....  | 27        |
| 10.3.      | Severity Levels and Performance Criterion .....            | 27        |
| 10.4.      | EUT Configuration on Test .....                            | 28        |
| 10.5.      | Operating Condition of EUT .....                           | 28        |
| 10.6.      | Test Procedure .....                                       | 28        |
| 10.7.      | Test Results .....   | 28        |
| <b>11.</b> | <b>SURGE TEST .....</b>                                    | <b>29</b> |
| 11.1.      | Block Diagram of EUT Test Setup .....                      | 29        |
| 11.2.      | Test Standard .....  | 29        |
| 11.3.      | Severity Levels and Performance Criterion .....            | 29        |
| 11.4.      | EUT Configuration on Test .....                            | 30        |
| 11.5.      | Operating Condition of EUT .....                           | 30        |
| 11.6.      | Test Procedure .....                                       | 30        |
| 11.7.      | Test Result .....  | 30        |
| <b>12.</b> | <b>INJECTED CURRENTS SUSCEPTIBILITY TEST .....</b>         | <b>31</b> |
| 12.1.      | Block Diagram of EUT Test Setup .....                      | 31        |
| 12.2.      | Test Standard .....  | 31        |
| 12.3.      | Severity Levels and Performance Criterion .....            | 31        |
| 12.4.      | EUT Configuration on Test .....                            | 32        |
| 12.5.      | Operating Condition of EUT .....                           | 32        |
| 12.6.      | Test Procedure .....                                       | 32        |
| 12.7.      | Test Result .....  | 33        |
| <b>13.</b> | <b>MAGNETIC FIELD IMMUNITY TEST .....</b>                  | <b>34</b> |
| 13.1.      | Block Diagram of Test Setup .....                          | 34        |
| 13.2.      | Test Standard .....  | 34        |
| 13.3.      | Severity Levels and Performance Criterion .....            | 34        |
| 13.4.      | EUT Configuration on Test .....                            | 35        |
| 13.5.      | Operating Condition of EUT .....                           | 35        |
| 13.6.      | Test Procedure .....                                       | 35        |
| 13.7.      | Test Results .....   | 35        |
| <b>14.</b> | <b>VOLTAGE DIPS AND INTERRUPTIONS TEST .....</b>           | <b>37</b> |
| 14.1.      | Block Diagram of EUT Test Setup .....                      | 37        |
| 14.2.      | Test Standard .....  | 37        |
| 14.3.      | Severity Levels and Performance Criterion .....            | 37        |
| 14.4.      | EUT Configuration on Test .....                            | 38        |
| 14.5.      | Operating Condition of EUT .....                           | 38        |
| 14.6.      | Test Procedure .....                                       | 38        |
| 14.7.      | Test Result .....  | 38        |
| <b>15.</b> | <b>EUT PHOTOGRAPHS .....</b>                               | <b>39</b> |

**SHENZHEN YARUI TESTING CO., LTD.**

Address: No.1107-1109, Weidonglong Technology Building, Meilong Avenue, Qinghu Longhua District ,  
 Shenzhen 518109, Guangdong, China  
 Tel.: +86-755-27912080 Fax.: +86-755-27916936 Website: www.yarui-lab.com

Applicant : Xiamen Black And White Guest Culture Technology  
Address : 608 B, 6th Floor, North District, Yihua Center, No.1 Qishan Road, Huli District, Xiamen City, Fujian Province, China  
Manufacturer : Xiamen Shengli Creation Electronic Technology Co. Ltd  
Address : 6/F, Sanluoli, Pan Tu Cun, Xike Town, Tongan District, Xiamen City, Fujian Province, China  
EUT : Cylindrical Timing Night Light  
Model Number : HBKYZD-01  
Trademark: : HBK  
**Test Result:** : The equipment under test was found to be compliance with the requirements of the standards applied.

## Test Procedure Used:

EMI : EN IEC 55015:2019+A11:2020  
EN IEC 61000-3-2:2019/A1:2021  
EN 61000-3-3: 2013+A1:2019

EMS : EN 61547:2009  
EN 61000-4-2:2009, EN IEC 61000-4-3:2020, EN 61000-4-4:2012,  
EN 61000-4-5:2014+A1:2017, EN 61000-4-6:2014, EN 61000-4-8:2010,  
EN IEC 61000-4-11:2020

Prepared by(Engineer): David Zhong



Reviewer(Supervisor): Tony Wang



Approved(Manager): Lily Yu



*This test report is based on a single evaluation of one sample of above mentioned products. It is not permitted to be duplicated in extracts without written approval of SHENZHEN YARUI TESTING CO., LTD.*

**SHENZHEN YARUI TESTING CO., LTD.**

Address: No.1107-1109, Weidonglong Technology Building, Meilong Avenue, Qinghu Longhua District ,  
Shenzhen 518109, Guangdong, China  
Tel.: +86-755-27912080 Fax.: +86-755-27916936 Website: www.yarui-lab.com

## 1. GENERAL INFORMATION

### 1.1. Description of Device (EUT)

EUT : Cylindrical Timing Night Light  
Trademark : HBK  
Model Number : HBKYZD-01  
Model Difference : N/A  
Power Supply : 3.7VDC for battery  
: 5VDC 1A for charging

### 1.2. Tested System Details

None.

### 1.3. Test Uncertainty

Conducted Emission :  $\pm 2.66$ dB  
Uncertainty

Radiated Emission Uncertainty :  $\pm 4.26$ dB

## SHENZHEN YARUI TESTING CO., LTD.

Address: No.1107-1109, Weidonglong Technology Building, Meilong Avenue, Qinghu Longhua District ,  
Shenzhen 518109, Guangdong, China  
Tel.: +86-755-27912080 Fax.: +86-755-27916936 Website: www.yarui-lab.com

## 1.4. Test Facility

### Site Description

Name of Firm : SHENZHEN YARUI TESTING CO., LTD.  
Site Location : NO. 101, Yousong Road, Longhua District, Shenzhen,  
China  
Lab Qualifications : Certificated by Industry Canada  
Registration No.: 12655A

Certificated by FCC, USA  
Registration No.: 187086

### **SHENZHEN YARUI TESTING CO., LTD.**

Address: No.1107-1109, Weidonglong Technology Building, Meilong Avenue, Qinghu Longhua District ,  
Shenzhen 518109, Guangdong, China  
Tel.: +86-755-27912080 Fax.: +86-755-27916936 Website: [www.yarui-lab.com](http://www.yarui-lab.com)

## 2. TEST INSTRUMENT USED

### For Conducted Emission at the mains terminals Test

| Conducted Emission Test ( A --- site ) |              |          |         |               |               |
|--|--------------|----------|---------|---------------|---------------|
| Equipment                              | Manufacturer | Model#   | Serial# | Last Cal.     | Next Cal.     |
| 843 Shielded Room                      | ChengYu      | 843 Room | 843     | Dec. 05, 2020 | Dec. 06, 2021 |
| EMI Receiver                           | R&S          | ESCI     | 101421  | Dec. 05, 2020 | Dec. 06, 2021 |
| LISN                                   | Schwarzbeck  | NSLK8127 | 8127739 | Dec. 05, 2020 | Dec. 06, 2021 |
| Attenuator                             | R&S          | ESH3-Z2  | YRT021E | Dec. 05, 2020 | Dec. 06, 2021 |
| 843 Cable 1#                           | FUJIKURA     | 843C1#   | 001     | Dec. 05, 2020 | Dec. 06, 2021 |

### For Magnetic Emission Test

| Conducted Emission Test ( A --- site ) |              |          |         |               |               |
|--|--------------|----------|---------|---------------|---------------|
| Equipment                              | Manufacturer | Model#   | Serial# | Last Cal.     | Next Cal.     |
| 843 Shielded Room                      | ChengYu      | 843 Room | 843     | Dec. 05, 2020 | Dec. 06, 2021 |
| EMI Receiver                           | R&S          | ESCI     | 101421  | Dec. 05, 2020 | Dec. 06, 2021 |
| Three-loop antenna                     | DAZE         | ZN30401  | 13017   | Dec. 05, 2020 | Dec. 06, 2021 |
| Attenuator                             | R&S          | ESH3-Z2  | YRT021E | Dec. 05, 2020 | Dec. 06, 2021 |
| 843 Cable 2#                           | FUJIKURA     | 843C1#   | 002     | Dec. 05, 2020 | Dec. 06, 2021 |

### For Radiated Emission Test

| Radiation Emission Test (966 chamber) |              |           |               |               |               |
|---------------------------------------|--------------|-----------|---------------|---------------|---------------|
| Equipment                             | Manufacturer | Model#    | Serial#       | Last Cal.     | Next Cal.     |
| 966 chamber                           | ChengYu      | 966 Room  | 966           | Dec. 05, 2020 | Dec. 06, 2021 |
| Spectrum Analyzer                     | Agilent      | E4407B    | MY45109572    | Dec. 05, 2020 | Dec. 06, 2021 |
| Amplifier                             | Schwarzbeck  | BBV9743   | 9743-119      | Dec. 05, 2020 | Dec. 06, 2021 |
| Amplifier                             | Schwarzbeck  | BBV9718   | 9718-270      | Dec. 05, 2020 | Dec. 06, 2021 |
| Log-periodic Antenna                  | Schwarzbeck  | VULB9160  | VULB9160-3369 | Dec. 05, 2020 | Dec. 06, 2021 |
| EMI Receiver                          | R&S          | ESCI      | 101421        | Dec. 05, 2020 | Dec. 06, 2021 |
| Horn Antenna                          | Schwarzbeck  | BBHA9120D | 9120D-1275    | Dec. 05, 2020 | Dec. 06, 2021 |
| 966 Cable 1#                          | CHENGYU      | 966       | 004           | Dec. 05, 2020 | Dec. 06, 2021 |
| 966 Cable 2#                          | CHENGYU      | 966       | 003           | Dec. 05, 2020 | Dec. 06, 2021 |

### SHENZHEN YARUI TESTING CO., LTD.

### For Harmonic & Flicker Test

| For Harmonic / Flicker Test ( A --- site ) |              |           |          |               |               |
|--|--------------|-----------|----------|---------------|---------------|
| Equipment                                  | Manufacturer | Model#    | Serial#  | Last Cal.     | Next Cal.     |
| Harmonic / Flicker Analyzer                | KIKUSUI      | KHA1000   | VA002445 | Dec. 05, 2020 | Dec. 06, 2021 |
| AC Power Supply                            | KIKUSUI      | PCR4000M  | UK001879 | Dec. 05, 2020 | Dec. 06, 2021 |
| Line Impedance network                     | KIKUSUI      | LIN1020JF | UL001611 | Dec. 05, 2020 | Dec. 06, 2021 |

### For Electrostatic Discharge Immunity Test

| For Electrostatic Discharge Immunity Test ( A --- site ) |              |          |          |               |               |
|--|--------------|----------|----------|---------------|---------------|
| Equipment  | Manufacturer | Model#   | Serial#  | Last Cal.     | Next Cal.     |
| ESD Tester   | KIKUSUI      | KES4201A | UH002321 | Dec. 05, 2020 | Dec. 06, 2021 |

### For RF Field Strength Susceptibility Test(SMQ)

| For RF Field Strength Susceptibility Test (SMQ --- site ) |              |             |            |               |               |
|---|--------------|-------------|------------|---------------|---------------|
| Equipment   | Manufacturer | Model#      | Serial#    | Last Cal.     | Next Cal.     |
| Signal Generator  | HP           | 8648A       | 3625U00573 | Dec. 05, 2020 | Dec. 06, 2021 |
| Amplifier   | A&R          | 500A100     | 17034      | Dec. 05, 2020 | Dec. 06, 2021 |
| Amplifier   | A&R          | 100W/1000M1 | 17028      | Dec. 05, 2020 | Dec. 06, 2021 |
| Audio Analyzer (20Hz~1GHz)                                | Panasonic    | 2023B       | 202301/428 | Dec. 05, 2020 | Dec. 06, 2021 |
| Isotropic Field Probe                                     | A&R          | FP2000      | 16755      | Dec. 05, 2020 | Dec. 06, 2021 |
| Antenna   | EMCO         | 3108        | 9507-2534  | Dec. 05, 2020 | Dec. 06, 2021 |
| Log-periodic Antenna                                      | A&R          | AT1080      | 16812      | Dec. 05, 2020 | Dec. 06, 2021 |

### For Electrical Fast Transient /Burst Immunity Test

| For Electrical Fast Transient/Burst Immunity Test ( A --- site ) |              |            |            |               |               |
|--|--------------|------------|------------|---------------|---------------|
| Equipment  | Manufacturer | Model#     | Serial#    | Last Cal.     | Next Cal.     |
| Burst Tester   | Prima        | EFT61004AG | PR14054467 | Dec. 05, 2020 | Dec. 06, 2021 |
| Coupling Clamp   | Prima        | EFT61004AG | YRT009E    | Dec. 05, 2020 | Dec. 06, 2021 |

## SHENZHEN YARUI TESTING CO., LTD.

Address: No.1107-1109, Weidonglong Technology Building, Meilong Avenue, Qinghu Longhua District ,  
Shenzhen 518109, Guangdong, China  
Tel.: +86-755-27912080 Fax.: +86-755-27916936 Website: www.yarui-lab.com



### For Surge Test

| For Surge Test ( A --- site ) |              |            |            |               |               |
|-------------------------------|--------------|------------|------------|---------------|---------------|
| Equipment                     | Manufacturer | Model#     | Serial#    | Last Cal.     | Next Cal.     |
| Surge Tester                  | Prima        | SUG61005BX | PR12045446 | Dec. 05, 2020 | Dec. 06, 2021 |

### For Injected Currents Susceptibility Test

| For Injected Currents Susceptibility Test ( A --- site ) |              |          |                   |               |               |
|--|--------------|----------|-------------------|---------------|---------------|
| Equipment  | Manufacturer | Model#   | Serial#           | Last Cal.     | Next Cal.     |
| C/S Test System  | SCHLODER     | CDG600   | 126B1281          | Dec. 05, 2020 | Dec. 06, 2021 |
| CDN  | SCHLODER     | CDN-M2+3 | A2210320/20<br>15 | Dec. 05, 2020 | Dec. 06, 2021 |
| Injection Clamp  | SCHLOBER     | EMCL-20  | 132A1214/20<br>15 | Dec. 05, 2020 | Dec. 06, 2021 |

### For Magnetic Field Immunity Test

| For Magnetic Field Immunity Test ( A --- site ) |              |        |         |               |               |
|---|--------------|--------|---------|---------------|---------------|
| Equipment                                       | Manufacturer | Model# | Serial# | Last Cal.     | Next Cal.     |
| Magnetic field generator                        | HTEC         | HPFMF  | 15701   | Dec. 05, 2020 | Dec. 06, 2021 |

### For Voltage Dips Interruptions Test

| For Voltage Dips Interruptions Test ( A --- site ) |              |            |            |               |               |
|--|--------------|------------|------------|---------------|---------------|
| Equipment  | Manufacturer | Model#     | Serial#    | Last Cal.     | Next Cal.     |
| Dips Tester  | Prima        | DRP61011AG | PR14086284 | Dec. 05, 2020 | Dec. 06, 2021 |

## SHENZHEN YARUI TESTING CO., LTD.

### 3. CONDUCTED EMISSION AT THE MAINS TERMINALS TEST

#### 3.1. Block Diagram Of Test Setup

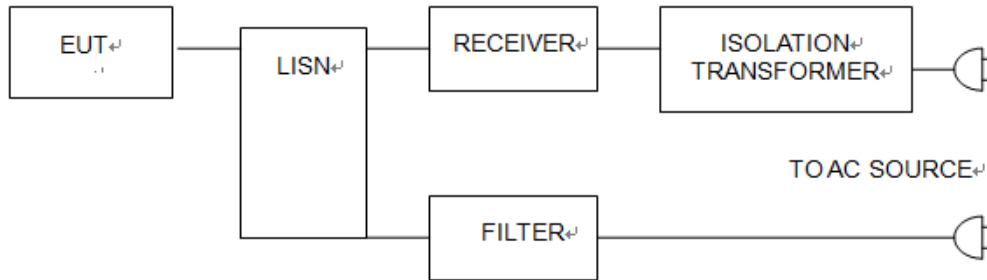

#### 3.2. Test Standard

EN 55015:2013+A1:2015

#### 3.3. Power Line Conducted Emission Limit

| Frequency<br>MHz | Limits dB( $\mu$ V) |               |
|------------------|---------------------|---------------|
|                  | Quasi-peak Level    | Average Level |
| 0.009 ~ 0.05     | 110                 | N/A           |
| 0.05 ~ 0.15      | 90 ~ 80*            | N/A           |
| 0.15 ~ 0.50      | 66 ~ 56*            | 56 ~ 46*      |
| 0.50 ~ 5.00      | 56                  | 46            |
| 5.00 ~ 30.00     | 60                  | 50            |

Notes: 1. \*Decreasing linearly with logarithm of frequency.

2. The lower limit shall apply at the transition frequencies.

#### 3.4. EUT Configuration on Test

The following equipments are installed on conducted emission test to meet EN55015 requirement and operating in a manner which tends to maximize its emission characteristics in a normal application.

#### 3.5. Operating Condition of EUT

3.5.1 Setup the EUT and simulators as shown in Section 3.1.

3.5.2 Turn on the power of all equipments.

3.5.3 Let the EUT work in test modes and test it.

#### SHENZHEN YARUI TESTING CO., LTD.

Address: No.1107-1109, Weidonglong Technology Building, Meilong Avenue, Qinghu Longhua District ,  
Shenzhen 518109, Guangdong, China

Tel.: +86-755-27912080 Fax.: +86-755-27916936 Website: www.yarui-lab.com

### 3.6. Test Procedure

The EUT is put on the ground and connected to the AC mains through a Artificial Mains Network (AMN). This provided a 50ohm coupling impedance for the tested equipments. Both sides of AC line are checked to find out the maximum conducted emission levels according to the **EN55015** regulations during conducted emission test.

The bandwidth of the test receiver (R&S Test Receiver ESCI) is set at 10KHz.

The frequency range from 150 KHz to 30 MHz is investigated.

### 3.7. Test Result

The product's power provide by DC, no requirement for this item.

#### **SHENZHEN YARUI TESTING CO., LTD.**

Address: No.1107-1109, Weidonglong Technology Building, Meilong Avenue, Qinghu Longhua District ,  
Shenzhen 518109, Guangdong, China  
Tel.: +86-755-27912080 Fax.: +86-755-27916936 Website: [www.yarui-lab.com](http://www.yarui-lab.com)

## 4. MAGNETIC EMISSION TEST

### 4.1. Block Diagram Of Test Setup

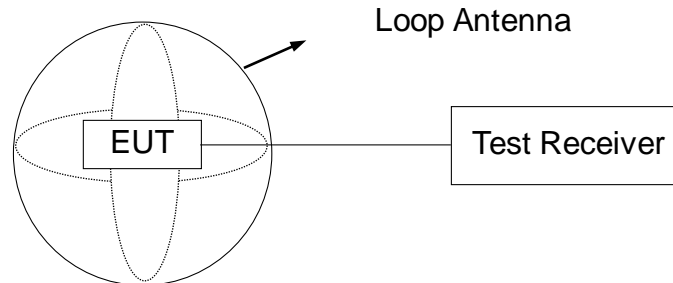

### 4.2. Test Standard

EN 55015:2013+A1:2015

### 4.3. Power Line Conducted Emission Limit

| Frequency<br>MHz | Limits dB( $\mu$ A) |
|------------------|---------------------|
|                  | Quasi-peak Level    |
| 0.009 ~ 0.07     | 88                  |
| 0.07 ~ 0.15      | 88 ~ 58*            |
| 0.15 ~ 0.50      | 58 ~ 22*            |
| 0.50 ~ 5.00      | 22                  |

Notes: 1. \*Decreasing linearly with logarithm of frequency.  
2. The lower limit shall apply at the transition frequencies.

### 4.4. EUT Configuration on Test

The following equipments are installed on conducted emission test to meet EN55015 requirement and operating in a manner which tends to maximize its emission characteristics in a normal application.

### 4.5. Operating Condition of EUT

3.5.1 Setup the EUT and simulators as shown in Section 3.1.

3.5.2 Turn on the power of all equipments.

3.5.3 Let the EUT work in test modes and test it.

## SHENZHEN YARUI TESTING CO., LTD.

Address: No.1107-1109, Weidonglong Technology Building, Meilong Avenue, Qinghu Longhua District ,  
Shenzhen 518109, Guangdong, China  
Tel.: +86-755-27912080 Fax.: +86-755-27916936 Website: www.yarui-lab.com

#### 4.6. Test Procedure

The EUT is placed on a wood table in the center of a loop antenna. The induced current in the loop antenna is measured by means of a current probe and the test receiver. Three field components is checked by means of a coax switch.

The frequency range from 9KHz to 30MHz is investigated. The receiver is measured with the quasi-peak detector. For frequency band 9KHz to 150KHz, the bandwidth of the field strength meter (R&S Test Receiver ESCI) is set at 200Hz. For frequency band 150KHz to 30MHz , the bandwidth is set at 10KHz.

#### 4.7. Test Result

PASS

### **SHENZHEN YARUI TESTING CO., LTD.**

Address: No.1107-1109, Weidonglong Technology Building, Meilong Avenue, Qinghu Longhua District ,  
Shenzhen 518109, Guangdong, China

Tel.: +86-755-27912080 Fax.: +86-755-27916936 Website: [www.yarui-lab.com](http://www.yarui-lab.com)

## 5. RADIATION EMISSION TEST

### 5.1. Block Diagram of Test Setup

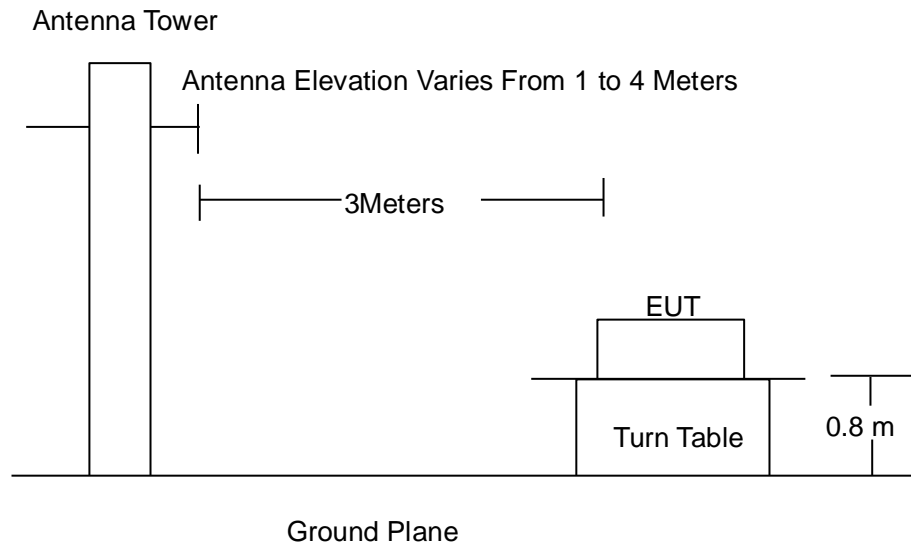

### 5.2. Test Standard

EN 55015:2013+A1:2015

### 5.3. Radiation Limit

| Frequency<br>MHz | Distance<br>(Meters) | Field Strengths Limits<br>dB( $\mu$ V)/m |
|------------------|----------------------|--|
| 30 ~ 230         | 3                    | 40.0                                     |
| 230 ~ 300        | 3                    | 47.0                                     |

Remark:

- (1) Emission level (dB( $\mu$ V)/m) = 20 log Emission level ( $\mu$ V/m)
- (2) The smaller limit shall apply at the cross point between two frequency bands.
- (3) Distance refers to the distance in meters between the measuring instrument, antenna and the closed point of any part of the device or system.

### 5.4. EUT Configuration on Test

The EN55015 regulations test method must be used to find the maximum emission during radiated emission test.

The configuration of EUT is the same as used in conducted emission test. Please refer to Section 2.2.

### SHENZHEN YARUI TESTING CO., LTD.

Address: No.1107-1109, Weidonglong Technology Building, Meilong Avenue, Qinghu Longhua District ,  
Shenzhen 518109, Guangdong, China  
Tel.: +86-755-27912080 Fax.: +86-755-27916936 Website: www.yarui-lab.com

### 5.5. Operating Condition of EUT

Same as conducted emission test, which is listed in Section 2.2 except the test set up replaced as Section 4.1.

### 5.6. Test Procedure

The EUT and its simulators are placed on a turned table that is 0.8 meter above the ground. The turned table can rotate 360 degrees to determine the position of the maximum emission level. The EUT is set 3 meters away from the receiving antenna that is mounted on the antenna tower. The antenna can move up and down between 1 meter and 4 meters to find out the maximum emission level. Broadband antenna (calibrated biconical and log periodical antenna) is used as receiving antenna. Both horizontal and vertical polarization of the antenna is set on test. In order to find the maximum emission levels, the interface cable must be manipulated according to EN55015 on radiated emission test.

The bandwidth setting on the field strength meter (R&S Test Receiver ESCI) is set at 120KHz.

The frequency range from 30MHz to 1000MHz is checked.

### 5.7. Test Result

**PASS**

Please refer to the following page.

## **SHENZHEN YARUI TESTING CO., LTD.**

Address: No.1107-1109, Weidonglong Technology Building, Meilong Avenue, Qinghu Longhua District ,  
Shenzhen 518109, Guangdong, China

Tel.: +86-755-27912080 Fax.: +86-755-27916936 Website: [www.yarui-lab.com](http://www.yarui-lab.com)

| Radiation Emission Test Data |         |                    |            |
|------------------------------|---------|--------------------|------------|
| Temperature:                 | 24.5 °C | Relative Humidity: | 54%        |
| Pressure:                    | 1009hPa | Phase :            | Horizontal |
| Test Voltage :               | DC 3.7V | Test Mode:         | ON Mode    |

| No. | Mk. | Freq.    | Reading Level | Correct Factor | Measurement | Limit  | Over   | Antenna Height | Table Degree |         |
|-----|-----|----------|---------------|----------------|-------------|--------|--------|----------------|--------------|---------|
|     |     | MHz      | dBuV          | dB/m           | dBuV/m      | dBuV/m | dB     | cm             | degree       | Comment |
| 1   |     | 35.9850  | 27.73         | -9.89          | 17.84       | 40.00  | -22.16 | peak           |              |         |
| 2   |     | 47.0025  | 28.09         | -10.24         | 17.85       | 40.00  | -22.15 | peak           |              |         |
| 3   |     | 71.9649  | 26.72         | -13.48         | 13.24       | 40.00  | -26.76 | peak           |              |         |
| 4   |     | 120.5372 | 33.25         | -10.98         | 22.27       | 40.00  | -17.73 | peak           |              |         |
| 5   | *   | 165.6232 | 31.18         | -8.74          | 22.44       | 40.00  | -17.56 | peak           |              |         |
| 6   |     | 267.9916 | 32.96         | -8.76          | 24.20       | 47.00  | -22.80 | peak           |              |         |



**SHENZHEN YARUI TESTING CO., LTD.**

Address: No.1107-1109, Weidonglong Technology Building, Meilong Avenue, Qinghu Longhua District ,  
 Shenzhen 518109, Guangdong, China  
 Tel.: +86-755-27912080 Fax.: +86-755-27916936 Website: www.yarui-lab.com



| Radiation Emission Test Data |         |                    |          |
|------------------------------|---------|--------------------|----------|
| Temperature:                 | 24.5 °C | Relative Humidity: | 54%      |
| Pressure:                    | 1009hPa | Phase :            | Vertical |
| Test Voltage :               | DC 3.7V | Test Mode:         | ON Mode  |

| No. | Mk. | Freq.    | Reading Level | Correct Factor | Measurement | Limit  | Over   | Antenna Height | Table Degree |         |
|-----|-----|----------|---------------|----------------|-------------|--------|--------|----------------|--------------|---------|
|     |     | MHz      | dBuV          | dB/m           | dBuV/m      | dBuV/m | dB     | cm             | degree       | Comment |
| 1   | *   | 45.5115  | 40.71         | -10.13         | 30.58       | 40.00  | -9.42  | peak           |              |         |
| 2   |     | 87.9268  | 27.88         | -13.94         | 13.94       | 40.00  | -26.06 | peak           |              |         |
| 3   |     | 117.7935 | 28.59         | -11.28         | 17.31       | 40.00  | -22.69 | peak           |              |         |
| 4   |     | 167.9273 | 33.50         | -8.90          | 24.60       | 40.00  | -15.40 | peak           |              |         |
| 5   |     | 200.0420 | 26.67         | -11.30         | 15.37       | 40.00  | -24.63 | peak           |              |         |
| 6   |     | 258.2981 | 31.14         | -9.05          | 22.09       | 47.00  | -24.91 | peak           |              |         |

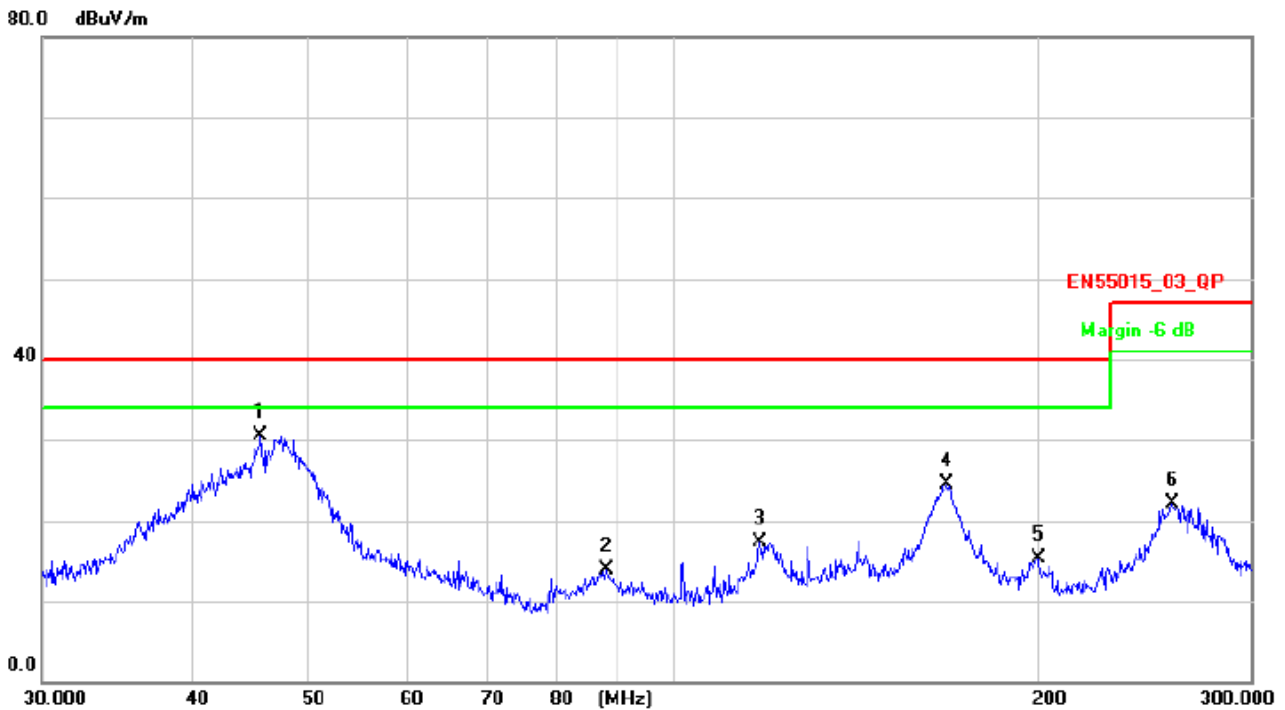

**SHENZHEN YARUI TESTING CO., LTD.**

Address: No.1107-1109, Weidonglong Technology Building, Meilong Avenue, Qinghu Longhua District ,  
 Shenzhen 518109, Guangdong, China  
 Tel.: +86-755-27912080 Fax.: +86-755-27916936 Website: www.yarui-lab.com

## 6. HARMONIC CURRENT EMISSION TEST

### 6.1. Block Diagram of Test Setup

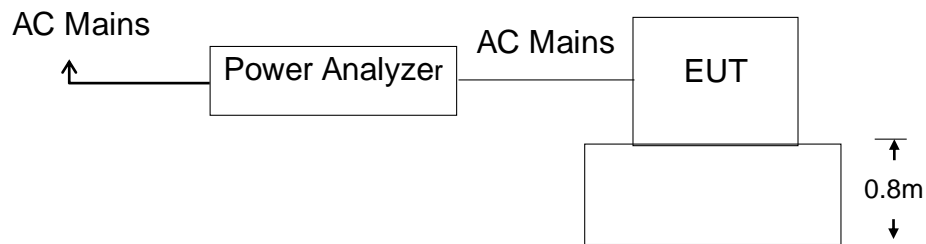

### 6.2. Test Standard

EN IEC 61000-3-2:2019/A1:2021

### 6.3. Operating Condition of EUT

- 5.1.1 Setup the EUT as shown in Section 5.1.
- 5.1.2 Turn on the power of all equipments.
- 5.1.3 Let the EUT work in test mode and test it.

### 6.4. Test Procedure

The power cord of the EUT is connected to the output of the test system. Turn on the power of the EUT and use the test system to test the harmonic current level.

### 6.5. Test Results

**PASS**

Please refer to the following page.

There is no need for Harmonic current test to be performed on this product (rated power is less than 75 W) in accordance with EN IEC 61000-3-2.

For further details, please refer to Clause 7 of EN IEC 61000-3-2 which states:

“For the following categories of equipment, limits are not specified in this standard:

- equipment with a rated power of 75 W or less, other than lighting equipment.”

## SHENZHEN YARUI TESTING CO., LTD.

Address: No.1107-1109, Weidonglong Technology Building, Meilong Avenue, Qinghu Longhua District ,  
Shenzhen 518109, Guangdong, China

Tel.: +86-755-27912080 Fax.: +86-755-27916936 Website: www.yarui-lab.com

## 7. VOLTAGE FLUCTUATIONS & FLICKER TEST

### 7.1. Block Diagram of Test Setup

Same as Section 6.1..

### 7.2. Test Standard

EN 61000-3-3: 2013+A1:2019

### 7.3. Operating Condition of EUT

Same as Section 5.3.. The power cord of the EUT is connected to the output of the test system. Turn on the power of the EUT and use the test system to test the harmonic current level.

#### Flicker Test Limit

| Test items | Limits                    |
|------------|---------------------------|
| Pst        | 1.0                       |
| dc         | 3.3%                      |
| dmax       | 4.0%                      |
| dt         | Not exceed 3.3% for 500ms |

### 7.4. Test Procedure

The power cord of the EUT is connected to the output of the test system. Turn on the power of the EUT and use the test system to test the harmonic current level.

### 7.5. Test Results

The product's power provide by DC, no requirement for this item.

## SHENZHEN YARUI TESTING CO., LTD.

Address: No.1107-1109, Weidonglong Technology Building, Meilong Avenue, Qinghu Longhua District ,  
Shenzhen 518109, Guangdong, China

Tel.: +86-755-27912080 Fax.: +86-755-27916936 Website: www.yarui-lab.com

## 8. ELECTROSTATIC DISCHARGE IMMUNITY TEST

### 8.1. Block Diagram of Test Setup



### 8.2. Test Standard

EN 61547:2009, EN 61000-4-2:2009

Severity Level: 3 / Air Discharge:  $\pm 8\text{KV}$   
 Level: 2 / Contact Discharge:  $\pm 4\text{KV}$

### 8.3. Severity Levels and Performance Criterion

#### 7.3.1 Severity level

| Level | Test Voltage<br>Contact Discharge<br>(KV) | Test Voltage<br>Air Discharge (KV) |
|-------|---|------------------------------------|
| 1.    | $\pm 2$                                   | $\pm 2$                            |
| 2.    | $\pm 4$                                   | $\pm 4$                            |
| 3.    | $\pm 6$                                   | $\pm 8$                            |
| 4.    | $\pm 8$                                   | $\pm 15$                           |
| X     | Special                                   | Special                            |

### SHENZHEN YARUI TESTING CO., LTD.

Address: No.1107-1109, Weidonglong Technology Building, Meilong Avenue, Qinghu Longhua District ,  
 Shenzhen 518109, Guangdong, China  
 Tel.: +86-755-27912080 Fax.: +86-755-27916936 Website: www.yarui-lab.com

### 7.3.2 Performance criterion : B

A. The equipment shall continue to operate as intended without operator intervention. No degradation of performance or loss of function is allowed below a performance level specified by the manufacturer when the equipment is used as intended. The performance level may be replaced by a permissible loss of performance. If the minimum performance level or the permissible performance loss is not specified by the manufacturer, then either of these may be derived from the product description and documentation, and by what the user may reasonably expect from the equipment if used as intended.

B. After the test, the equipment shall continue to operate as intended without operator intervention. No degradation of performance or loss of function is allowed, after the application of the phenomena below a performance level specified by the manufacturer, when the equipment is used as intended. The performance level may be replaced by a permissible loss of performance.

During the test, degradation of performance is allowed. However, no change of operating state or stored data is allowed to persist after the test.

If the minimum performance level (or the permissible performance loss) is not specified by the manufacturer, then either of these may be derived from the product description and documentation, and by what the user may reasonably expect from the equipment if used as intended.

C. Loss of function is allowed, provided the function is self-recoverable, or can be restored by the operation of the controls by the user in accordance with the manufacturer's instructions. Functions, and/or information stored in non-volatile memory, or protected by a battery backup, shall not be lost.

## 8.4.EUT Configuration

The following equipments are installed on Electrostatic Discharge Immunity test to meet EN 61547:2009, EN 61000-4-2:2009, requirement and operating in a manner which tends to maximize its emission characteristics in a normal application. The configuration of EUT is the same as used in conducted emission test.

Please refer to Section 2.4.

### **SHENZHEN YARUI TESTING CO., LTD.**

Address: No.1107-1109, Weidonglong Technology Building, Meilong Avenue, Qinghu Longhua District ,

Shenzhen 518109, Guangdong, China

Tel.: +86-755-27912080 Fax.: +86-755-27916936 Website: www.yarui-lab.com

## 8.5. Operating Condition of EUT

Same as conducted emission measurement, which is listed in Section 3.5 except the test setup replaced by Section 7.1.2.

## 8.6. Test Procedure

### 7.6.1 Air Discharge:

This test is done on a non-conductive surface. The round discharge tip of the discharge electrode shall be approached as fast as possible to touch the EUT. After each discharge, the discharge electrode shall be removed from the EUT. The generator is then re-triggered for a new single discharge and repeated 10 times for each pre-selected test point. This procedure shall be repeated until all the air discharge completed.

### 7.6.2 Contact Discharge:

All the procedure shall be same as Section 7.6.1. Except that the tip of the discharge electrode shall touch the EUT before the discharge switch is operated.

### 7.6.3 Indirect discharge for horizontal coupling plane

At least 10 single discharges (in the most sensitive polarity) shall be applied at the front edge of each HCP opposite the center point of each unit (if applicable) of the EUT and 0.1m from the front of the EUT. The long axis of the discharge electrode shall be in the plane of the HCP and perpendicular to its front edge during the discharge.

### 7.6.4 Indirect discharge for vertical coupling plane

At least 10 single discharges (in the most sensitive polarity) shall be applied to the center of one vertical edge of the coupling plane. The coupling plane, of dimensions 0.5m X 0.5m, is placed parallel to, and positioned at a distance of 0.1m from the EUT. Discharges shall be applied to the coupling plane, with this plane in sufficient different positions that the four faces of the EUT are complete illuminated.

## 8.7. Test Results

**PASS**

Please refer to the following page.

### **SHENZHEN YARUI TESTING CO., LTD.**

| ESD Test Data            |               |                   |                       |        |
|--------------------------|---------------|-------------------|-----------------------|--------|
| Temperature:             | 24.5°C        | Humidity:         | 53%                   |        |
| Power Supply :           | DC 3.7V       | Test Mode:        | On                    |        |
| Air Discharge: ± 8KV     |               |                   |                       |        |
| Contact Discharge: ± 4KV |               |                   |                       |        |
| Test Points              | Air Discharge | Contact Discharge | Performance Criterion | Result |
| Enclosure                | ±2,4,8KV      | N/A               | B                     | PASS   |
| Slit                     | ±2,4,8KV      | N/A               | B                     | PASS   |
| Metal Part               | N/A           | ±2,4 KV           | B                     | PASS   |
| VCP                      | N/A           | ±2,4 KV           | B                     | PASS   |
| HCP                      | N/A           | ±2,4 KV           | B                     | PASS   |
| Note: N/A                |               |                   |                       |        |

**SHENZHEN YARUI TESTING CO., LTD.**

Address: No.1107-1109, Weidonglong Technology Building, Meilong Avenue, Qinghu Longhua District ,  
 Shenzhen 518109, Guangdong, China  
 Tel.: +86-755-27912080 Fax.: +86-755-27916936 Website: www.yarui-lab.com

## 9. RF FIELD STRENGTH SUSCEPTIBILITY TEST

### 9.1. Block Diagram of Test Setup

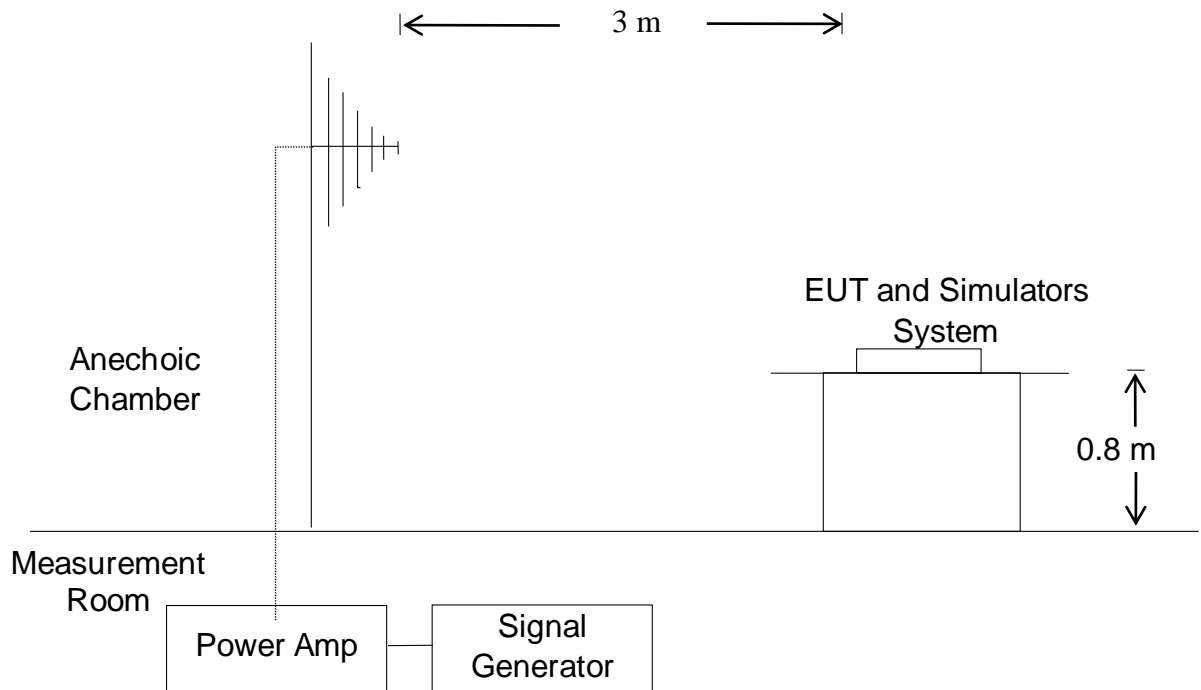

### 9.2. Test Standard

EN 61547:2009, EN IEC 61000-4-3:2020  
Severity Level 2, 3V / m

### 9.3. Severity Levels and Performance Criterion

#### 8.3.1. Severity level

| Level | Field Strength V/m |
|-------|--------------------|
| 1.    | 1                  |
| 2.    | 3                  |
| 3.    | 10                 |
| X.    | Special            |

### SHENZHEN YARUI TESTING CO., LTD.

Address: No.1107-1109, Weidonglong Technology Building, Meilong Avenue, Qinghu Longhua District ,  
Shenzhen 518109, Guangdong, China  
Tel.: +86-755-27912080 Fax.: +86-755-27916936 Website: www.yarui-lab.com



### 8.3.2. Performance criterion: A

- A、 The equipment shall continue to operate as intended without operator intervention. No degradation of performance or loss of function is allowed below a performance level specified by the manufacturer when the equipment is used as intended. The performance level may be replaced by a permissible loss of performance. If the minimum performance level or the permissible performance loss is not specified by the manufacturer, then either of these may be derived from the product description and documentation, and by what the user may reasonably expect from the equipment if used as intended.
- B、 After the test, the equipment shall continue to operate as intended without operator intervention. No degradation of performance or loss of function is allowed, after the application of the phenomena below a performance level specified by the manufacturer, when the equipment is used as intended. The performance level may be replaced by a permissible loss of performance.

During the test, degradation of performance is allowed. However, no change of operating state or stored data is allowed to persist after the test.

If the minimum performance level (or the permissible performance loss) is not specified by the manufacturer, then either of these may be derived from the product description and documentation, and by what the user may reasonably expect from the equipment if used as intended.

- C、 Loss of function is allowed, provided the function is self-recoverable, or can be restored by the operation of the controls by the user in accordance with the manufacturer's instructions. Functions, and/or information stored in non-volatile memory, or protected by a battery backup, shall not be lost.

## 9.4. EUT Configuration on Test

The following equipments are installed on Electrical Fast Transient/Burst Immunity test to meet EN 61547:2009, EN 61000-4-4:2012, requirement and operating in a manner which tends to maximize its emission characteristics in a normal application. The configuration of EUT is the same as used in conducted emission test.

Please refer to Section 3.4.

## 9.5. Operating Condition of EUT

Same as conducted emission measurement, which is listed in Section 2.5 except the test setup replaced by Section 8.1.

### **SHENZHEN YARUI TESTING CO., LTD.**

Address: No.1107-1109, Weidonglong Technology Building, Meilong Avenue, Qinghu Longhua District ,  
Shenzhen 518109, Guangdong, China  
Tel.: +86-755-27912080 Fax.: +86-755-27916936 Website: www.yarui-lab.com

### 9.6. Test Procedure

The EUT and its simulators are placed on a turn table which is 0.8 meter above ground. EUT is set 3 meter away from the transmitting antenna which is mounted on an antenna tower. Both horizontal and vertical polarization of the antenna are set on test. Each of the four sides of EUT must be faced this transmitting antenna and measured individually.

All the scanning conditions are as follows :

| Condition of Test         | Remarks                  |
|---------------------------|--------------------------|
| 1. Fielded Strength       | 3 V/m (Severity Level 2) |
| 2. Radiated Signal        | Modulated                |
| 3. Scanning Frequency     | 80 – 1000 MHz            |
| 4. Dwell time of radiated | 0.0015 decade/s          |
| 5. Waiting Time           | 1 Sec.                   |

### 9.7. Test Results

**PASS**

Please refer to the following page.

| R/S Test Data   |            |                                     |        |
|---|------------|-------------------------------------|--------|
| Temperature : 25°C  |            | Humidity : 53%                      |        |
| Field Strength: 3 V/m   |            | Criterion: A                        |        |
| Power Supply: DC 3.7V   |            | Frequency Range: 80 MHz to 1000 MHz |        |
| Modulation: <input checked="" type="checkbox"/> AM <input type="checkbox"/> Pulse <input type="checkbox"/> none    1 KHz    80% |            |                                     |        |
| Test Mode : On  |            |                                     |        |
| Frequency Range : 80-1000MHz  |            |                                     |        |
| Steps   | 1 %        |                                     |        |
|   | Horizontal | Vertical                            | Result |
| Front   | A          | A                                   | Pass   |
| Right   | A          | A                                   | Pass   |
| Rear  | A          | A                                   | Pass   |
| Left  | A          | A                                   | Pass   |
| Note: N/A   |            |                                     |        |

### SHENZHEN YARUI TESTING CO., LTD.

## 10. ELECTRICAL FAST TRANSIENT/BURST IMMUNITY TEST

### 10.1. Block Diagram of EUT Test Setup

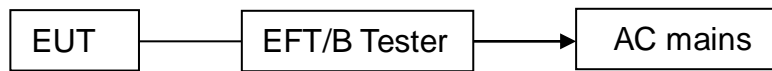

### 10.2. Test Standard

EN 61547:2009, EN 61000-4-4:2012

### 10.3. Severity Levels and Performance Criterion

Severity Level 2 at 1KV, Pulse Rise time & Duration: 5 nS / 50 nS

Severity Level:

| Open Circuit Output Test Voltage $\pm 10\%$ |                |  |
|---|----------------|--|
| Level                                       | On power ports | On I/O (Input/Output)<br>Signal data and control ports |
| 1.  | 0.5KV          | 0.25KV   |
| 2.  | 1KV            | 0.5KV  |
| 3.  | 2KV            | 1KV  |
| 4.  | 4KV            | 2KV  |
| X.  | Special        | Special  |

#### Performance criterion: B

- A. The equipment shall continue to operate as intended without operator intervention. No degradation of performance or loss of function is allowed below a performance level specified by the manufacturer when the equipment is used as intended. The performance level may be replaced by a permissible loss of performance. If the minimum performance level or the permissible performance loss is not specified by the manufacturer, then either of these may be derived from the product description and documentation, and by what the user may reasonably expect from the equipment if used as intended.
- B. After the test, the equipment shall continue to operate as intended without operator intervention. No degradation of performance or loss of function is allowed, after the application of the phenomena below a performance level specified by the manufacturer, when the equipment is used as intended. The performance level may be replaced by a permissible loss of performance.

During the test, degradation of performance is allowed. However, no change of operating state or stored data is allowed to persist after the test.

#### SHENZHEN YARUI TESTING CO., LTD.

Address: No.1107-1109, Weidonglong Technology Building, Meilong Avenue, Qinghu Longhua District ,

Shenzhen 518109, Guangdong, China

Tel.: +86-755-27912080 Fax.: +86-755-27916936 Website: www.yarui-lab.com

If the minimum performance level (or the permissible performance loss) is not specified by the manufacturer, then either of these may be derived from the product description and documentation, and by what the user may reasonably expect from the equipment if used as intended.

- C. Loss of function is allowed, provided the function is self-recoverable, or can be restored by the operation of the controls by the user in accordance with the manufacturer's instructions. Functions, and/or information stored in non-volatile memory, or protected by a battery backup, shall not be lost.

#### 10.4. EUT Configuration on Test

The following equipments are installed on Electrical Fast Transient/Burst Immunity test to meet EN 61547:2009, EN 61000-4-4:2012, requirement and operating in a manner which tends to maximize its emission characteristics in a normal application. The configuration of EUT is the same as used in conducted emission test. Please refer to Section 3.4.

#### 10.5. Operating Condition of EUT

Same as conducted emission measurement, which is listed in Section 2.6 except the test setup replaced by Section 9.1.

#### 10.6. Test Procedure

EUT shall be placed 0.8m high above the ground reference plane which is a min. 1m\*1m metallic sheet with 0.65mm minimum thickness. This reference ground plane shall project beyond the EUT by at least 0.1m on all sides and the minimum distance between EUT and all other conductive structure, except the ground plane beneath the EUT, shall be more than 0.5m

9.6.1. For input and output AC power ports:

The EUT is connected to the power mains by using a coupling device which couples the EFT interference signal to AC power lines. Both polarities of the test voltage should be applied during compliance test and the duration of the test is 2 minutes.

#### 10.7. Test Results

The product's power provide by DC, no requirement for this item.

### SHENZHEN YARUI TESTING CO., LTD.

## 11. SURGE TEST

### 11.1. Block Diagram of EUT Test Setup

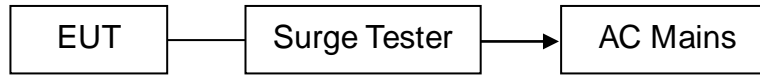

### 11.2. Test Standard

EN 61547:2009, EN 61000-4-5:2014+A1:2017

### 11.3. Severity Levels and Performance Criterion

Severity Level: Line to Line, Level 2 at 1KV;

Severity Level: Line to Earth, Level 3 at 2KV.

| Severity Level | Open-Circuit Test Voltage (KV) |
|----------------|--------------------------------|
| 1.             | 0.5                            |
| 2.             | 1.0                            |
| 3.             | 2.0                            |
| 4.             | 4.0                            |
| X.             | Special                        |

#### Performance criterion: B

- A. The equipment shall continue to operate as intended without operator intervention. No degradation of performance or loss of function is allowed below a performance level specified by the manufacturer when the equipment is used as intended. The performance level may be replaced by a permissible loss of performance. If the minimum performance level or the permissible performance loss is not specified by the manufacturer, then either of these may be derived from the product description and documentation, and by what the user may reasonably expect from the equipment if used as intended.
- B. After the test, the equipment shall continue to operate as intended without operator intervention. No degradation of performance or loss of function is allowed, after the application of the phenomena below a performance level specified by the manufacturer, when the equipment is used as intended. The performance level may be replaced by a permissible loss of performance.

During the test, degradation of performance is allowed. However, no change of operating state or stored data is allowed to persist after the test.

### SHENZHEN YARUI TESTING CO., LTD.

Address: No.1107-1109, Weidonglong Technology Building, Meilong Avenue, Qinghu Longhua District ,  
Shenzhen 518109, Guangdong, China  
Tel.: +86-755-27912080 Fax.: +86-755-27916936 Website: www.yarui-lab.com

If the minimum performance level (or the permissible performance loss) is not specified by the manufacturer, then either of these may be derived from the product description and documentation, and by what the user may reasonably expect from the equipment if used as intended.

- C. Loss of function is allowed, provided the function is self-recoverable, or can be restored by the operation of the controls by the user in accordance with the manufacturer's instructions. Functions, and/or information stored in non-volatile memory, or protected by a battery backup, shall not be lost.

#### 11.4. EUT Configuration on Test

The following equipments are installed on Electrical Fast Transient/Burst Immunity test to meet EN 61547:2009, EN 61000-4-5:2014+A1:2017, requirement and operating in a manner which tends to maximize its emission characteristics in a normal application

The configuration of EUT is the same as used in conducted emission test. Please refer to Section 3.4.

#### 11.5. Operating Condition of EUT

Same as conducted emission measurement, which is listed in Section 2.7 except the test setup replaced by Section 10.1.

#### 11.6. Test Procedure

- 1) Set up the EUT and test generator as shown on section 10.1
- 2) For line to line coupling mode, provide a 1KV 1.2/50us voltage surge (at open-circuit condition) and 8/20us current surge to EUT selected points.
- 3) At least 5 positive and 5 negative (polarity) tests with a maximum 1/min repetition rate are conducted during test.
- 4) Different phase angles are done individually.
- 5) Repeat procedure 2) to 4) except the open-circuit test voltage change from 1KV to 2KV for line to earth coupling mode test.
- 6) Record the EUT operating situation during compliance test and decide the EUT immunity criterion for above each test.

#### 11.7. Test Result

The product's power provide by DC, no requirement for this item.

### **SHENZHEN YARUI TESTING CO., LTD.**

## 12. INJECTED CURRENTS SUSCEPTIBILITY TEST

### 12.1. Block Diagram of EUT Test Setup

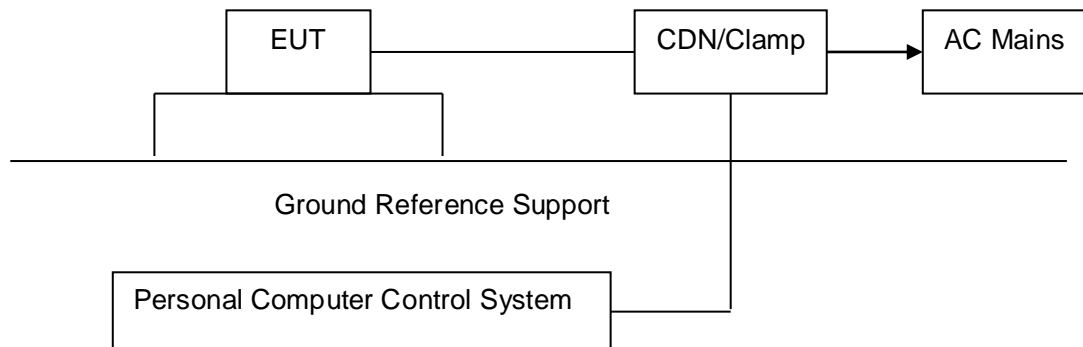

### 12.2. Test Standard

EN 61547:2009, EN61000-4-6:2014

### 12.3. Severity Levels and Performance Criterion

Severity Level 2: 3V( rms ), 150KHz ~ 80MHz

Severity Level:

| Level | Field Strength V |
|-------|------------------|
| 1.    | 1                |
| 2.    | 3                |
| 3.    | 10               |
| X.    | Special          |

#### Performance criterion: A

- A. The equipment shall continue to operate as intended without operator intervention. No degradation of performance or loss of function is allowed below a performance level specified by the manufacturer when the equipment is used as intended. The performance level may be replaced by a permissible loss of performance. If the minimum performance level or the permissible performance loss is not specified by the manufacturer, then either of these may be derived from the product description and documentation, and by what the user may reasonably expect from the equipment if used as intended.

### SHENZHEN YARUI TESTING CO., LTD.

Address: No.1107-1109, Weidonglong Technology Building, Meilong Avenue, Qinghu Longhua District ,  
Shenzhen 518109, Guangdong, China

Tel.: +86-755-27912080 Fax.: +86-755-27916936 Website: www.yarui-lab.com

- B. After the test, the equipment shall continue to operate as intended without operator intervention. No degradation of performance or loss of function is allowed, after the application of the phenomena below a performance level specified by the manufacturer, when the equipment is used as intended. The performance level may be replaced by a permissible loss of performance.

During the test, degradation of performance is allowed. However, no change of operating state or stored data is allowed to persist after the test.

If the minimum performance level (or the permissible performance loss) is not specified by the manufacturer, then either of these may be derived from the product description and documentation, and by what the user may reasonably expect from the equipment if used as intended.

- C. Loss of function is allowed, provided the function is self-recoverable, or can be restored by the operation of the controls by the user in accordance with the manufacturer's instructions. Functions, and/or information stored in non-volatile memory, or protected by a battery backup, shall not be lost.

#### 12.4. EUT Configuration on Test

The configuration of EUT is the same as used in conducted emission test. Please refer to Section 2.8.

#### 12.5. Operating Condition of EUT

Same as conducted emission test, which is listed in Section 2.8 except the test set up replaced as Section 11.1.

#### 12.6. Test Procedure

- 1) Set up the EUT, CDN and test generator as shown on section 11.1
- 2) Let EUT work in test mode and measure.
- 3) The EUT and supporting equipments are placed on an insulating support 0.1m high above a ground reference plane. CDN (coupling and decoupling device) is placed on the ground plane at above 0.1-0.3m from EUT. Cables between CDN and EUT are as short as possible, and their height above the ground reference plane shall be between 30 and 50 mm (where possible).
- 4) The disturbance signal described below is injected to EUT through CDN.
- 5) The EUT operates within its operational mode(s) under intended climatic conditions after power on.
- 6) The frequency range is swept from 150KHz to 80MHz using 3V signal level, and with the disturbance signal 80% amplitude modulated with a 1KHz sine wave

### **SHENZHEN YARUI TESTING CO., LTD.**



- 7) The rate of sweep shall not exceed  $1.5 \times 10^{-3}$  decades/s. Where the frequency is swept incrementally, the step size shall not exceed 1% of the start and thereafter 1% of the preceding frequency value.
- 8) Recording the EUT operating situation during compliance test and decide the EUT immunity criterion for above each test.

## 12.7. Test Result

The product's power provide by DC, no requirement for this item.

### **SHENZHEN YARUI TESTING CO., LTD.**

Address: No.1107-1109, Weidonglong Technology Building, Meilong Avenue, Qinghu Longhua District ,  
Shenzhen 518109, Guangdong, China

Tel.: +86-755-27912080 Fax.: +86-755-27916936 Website: [www.yarui-lab.com](http://www.yarui-lab.com)

## 13. MAGNETIC FIELD IMMUNITY TEST

### 13.1. Block Diagram of Test Setup

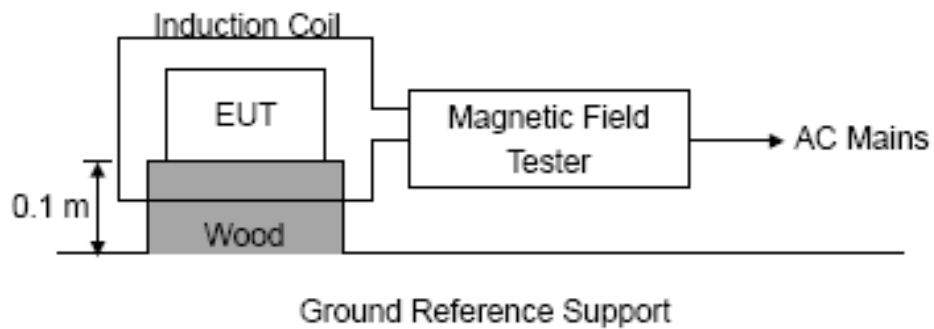

### 13.2. Test Standard

EN 61547:2009, EN61000-4-8:2010  
Severity Level 1 at 1A/m

### 13.3. Severity Levels and Performance Criterion

#### 12.3.1 Severity level

| Level | Magnetic Field Strength A/m |
|-------|-----------------------------|
| 1.    | 1                           |
| 2.    | 3                           |
| 3.    | 10                          |
| 4.    | 30                          |
| 5.    | 100                         |
| X.    | Special                     |

#### 12.3.2 Performance criterion: B

A. The equipment shall continue to operate as intended without operator intervention. No degradation of performance or loss of function is allowed below a performance level specified by the manufacturer when the equipment is used as intended. The performance level may be replaced by a permissible loss of performance. If the minimum performance level or the permissible performance loss is not specified by the manufacturer, then either of these may be derived from the product description and documentation, and by what the user may reasonably expect from the equipment if used as intended.

B. After the test, the equipment shall continue to operate as intended

### SHENZHEN YARUI TESTING CO., LTD.

Address: No.1107-1109, Weidonglong Technology Building, Meilong Avenue, Qinghu Longhua District ,  
Shenzhen 518109, Guangdong, China  
Tel.: +86-755-27912080 Fax.: +86-755-27916936 Website: www.yarui-lab.com

without operator intervention. No degradation of performance or loss of function is allowed, after the application of the phenomena below a performance level specified by the manufacturer, when the equipment is used as intended. The performance level may be replaced by a permissible loss of performance.

During the test, degradation of performance is allowed. However, no change of operating state or stored data is allowed to persist after the test.

If the minimum performance level (or the permissible performance loss) is not specified by the manufacturer, then either of these may be derived from the product description and documentation, and by what the user may reasonably expect from the equipment if used as intended.

- C. Loss of function is allowed, provided the function is self-recoverable, or can be restored by the operation of the controls by the user in accordance with the manufacturer's instructions. Functions, and/or information stored in non-volatile memory, or protected by a battery backup, shall not be lost.

#### 13.4. EUT Configuration on Test

The configuration of EUT is listed in Section 2.9.

#### 13.5. Operating Condition of EUT

Same as conducted emission test, which is listed in Section 2.9 except the test set up replaced as Section 12.1.

#### 13.6. Test Procedure

The EUT shall be subjected to the test magnetic field by using the induction coil of standard dimensions (1m\*1m) and shown in Section 10.1. The induction coil shall then be rotated by 90° in order to expose the EUT to the test field with different orientations.

#### 13.7. Test Results

**PASS**

Please refer to the following page.

### **SHENZHEN YARUI TESTING CO., LTD.**

| MS Test Data            |                    |       |                  |                       |        |
|-------------------------|--------------------|-------|------------------|-----------------------|--------|
| Temperature:            | 24.5°C             |       | Humidity:        | 53%                   |        |
| Power Supply :          | DC 3.7V            |       | Test Mode:       | On                    |        |
| Environmental Phenomena | Test specification | Units | Coil Orientation | Performance Criterion | Result |
| Magnetic Field          | 3                  | A/m   | X                | A                     | PASS   |
|                         |                    |       | Y                | A                     | PASS   |
|                         |                    |       | Z                | A                     | PASS   |
| Note: N/A               |                    |       |                  |                       |        |

**SHENZHEN YARUI TESTING CO., LTD.**

Address: No.1107-1109, Weidonglong Technology Building, Meilong Avenue, Qinghu Longhua District ,  
 Shenzhen 518109, Guangdong, China  
 Tel.: +86-755-27912080 Fax.: +86-755-27916936 Website: www.yarui-lab.com

## 14. VOLTAGE DIPS AND INTERRUPTIONS TEST

### 14.1. Block Diagram of EUT Test Setup



### 14.2. Test Standard

EN 61547:2009, EN IEC 61000-4-11:2020

### 14.3. Severity Levels and Performance Criterion

Severity Level:

Input and Output AC Power Ports.

Voltage Dips.

Voltage Interruptions.

| Environmental Phenomena | Test Specification | Units                 | Performance Criterion |
|-------------------------|--------------------|-----------------------|-----------------------|
| Voltage Dips            | 70<br>10           | % Reduction<br>period | C                     |
|                         | 0<br>0.5           | % Reduction<br>period | B                     |

**Performance criterion:** C, B

- A. The equipment shall continue to operate as intended without operator intervention. No degradation of performance or loss of function is allowed below a performance level specified by the manufacturer when the equipment is used as intended. The performance level may be replaced by a permissible loss of performance. If the minimum performance level or the permissible performance loss is not specified by the manufacturer, then either of these may be derived from the product description and documentation, and by what the user may reasonably expect from the equipment if used as intended.
- B. After the test, the equipment shall continue to operate as intended without operator intervention. No degradation of performance or loss of function is allowed, after the application of the phenomena below a performance level specified by the manufacturer, when the equipment is used as intended. The performance level may be replaced by a permissible loss of performance.

### SHENZHEN YARUI TESTING CO., LTD.

Address: No.1107-1109, Weidonglong Technology Building, Meilong Avenue, Qinghu Longhua District ,  
Shenzhen 518109, Guangdong, China  
Tel.: +86-755-27912080 Fax.: +86-755-27916936 Website: www.yarui-lab.com

During the test, degradation of performance is allowed. However, no change of operating state or stored data is allowed to persist after the test.

If the minimum performance level (or the permissible performance loss) is not specified by the manufacturer, then either of these may be derived from the product description and documentation, and by what the user may reasonably expect from the equipment if used as intended.

- C. Loss of function is allowed, provided the function is self-recoverable, or can be restored by the operation of the controls by the user in accordance with the manufacturer's instructions. Functions, and/or information stored in non-volatile memory, or protected by a battery backup, shall not be lost.

#### 14.4. EUT Configuration on Test

The configuration of EUT is the same as used in conducted emission test. Please refer to Section 2.10.

#### 14.5. Operating Condition of EUT

Same as conducted emission test, which is listed in Section 2.10 except the test set up replaced as Section 13.1.

#### 14.6. Test Procedure

- 1) Set up the EUT and test generator as shown on section 13.1
- 2) The interruption is introduced at selected phase angles with specified duration. There is a 3mins minimum interval between each test event.
- 3) After each test a full functional check is performed before the next test.
- 4) Repeat procedures 2 & 3 for voltage dips, only the level and duration is changed.
- 5) Record any degradation of performance.

#### 14.7. Test Result

The product's power provide by DC, no requirement for this item.

### **SHENZHEN YARUI TESTING CO., LTD.**

## 15. EUT PHOTOGRAPHS

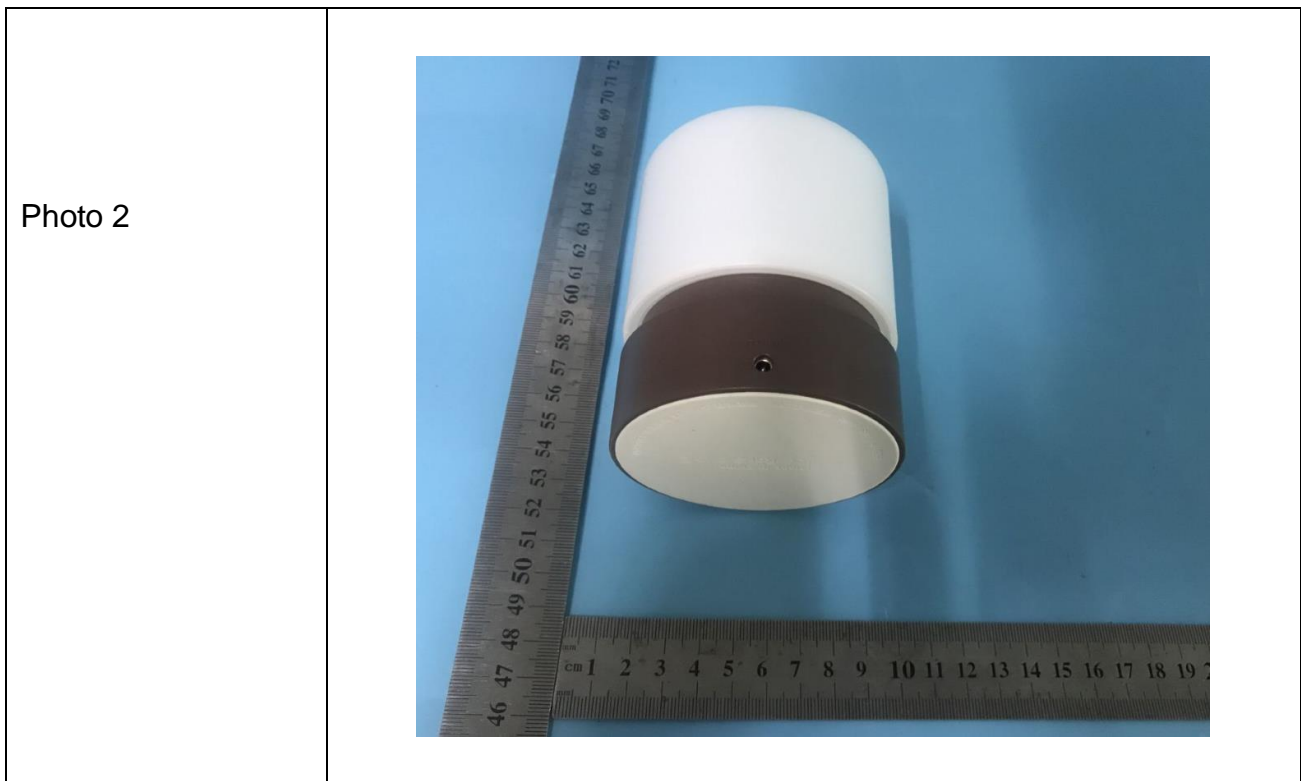
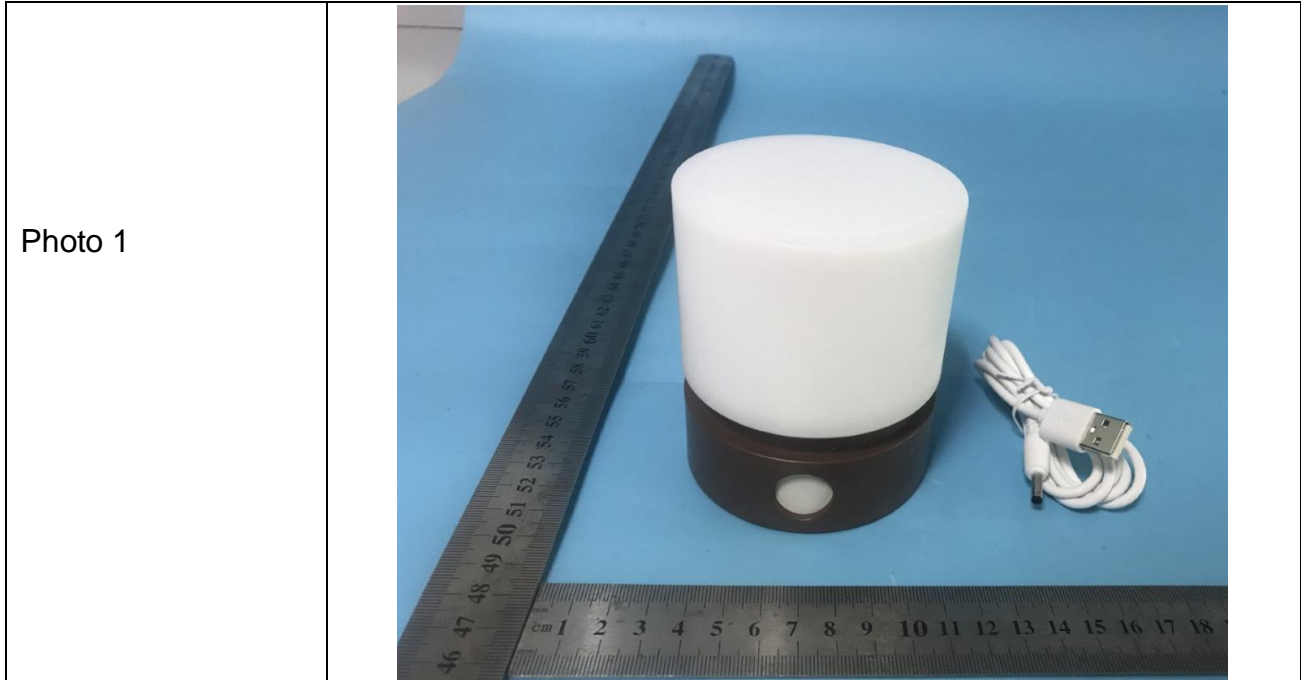

### SHENZHEN YARUI TESTING CO., LTD.

Address: No.1107-1109, Weidonglong Technology Building, Meilong Avenue, Qinghu Longhua District ,  
Shenzhen 518109, Guangdong, China

Tel.: +86-755-27912080 Fax.: +86-755-27916936 Website: [www.yarui-lab.com](http://www.yarui-lab.com)

Photo 3

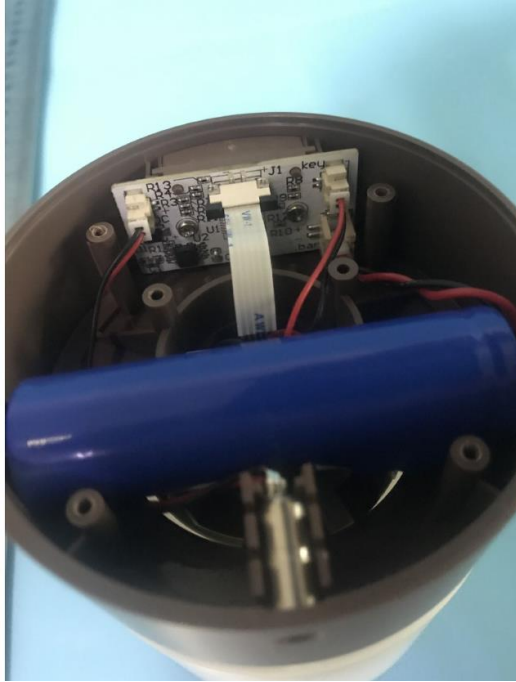

\*\*\*\*\* END OF REPORT \*\*\*\*\*

**SHENZHEN YARUI TESTING CO., LTD.**

Address: No.1107-1109, Weidonglong Technology Building, Meilong Avenue, Qinghu Longhua District ,  
Shenzhen 518109, Guangdong, China  
Tel.: +86-755-27912080 Fax.: +86-755-27916936 Website: [www.yarui-lab.com](http://www.yarui-lab.com)