

EN - Please read this instruction manual carefully before attempting to install.

DE - Bitte lesen Sie diese Bedienungsanleitung vor der Montage gründlich durch.

ES - Por favor lea con atención el manual de instrucciones antes de llevar a cabo el ensamble.

FR - Lisez attentivement cette notice avant de commencer le montage.

IT - Si prega di consultare il libretto delle istruzioni prima del montaggio.

IMPORTANT/WICHTIG/ATENCIÓN

IMPORTANT/IMPORTANTE



EN - We recommend **2** or more people to install.
DE - Wir empfehlen, dass die Montage von **2** oder mehreren Personen durchgeführt werden sollte.
ES - Recomendamos realizar el ensamble con **2** o más personas.
FR - Il est recommandé d'effectuer le montage à **2** personne(s) ou plus.
IT - È necessaria la presenza di **2** o più persone per il montaggio di questo prodotto.



EN - The expected assembly time is **1 h**.
DE - Die Montagezeit beträgt durchschnittlich **1 h**.
ES - El tiempo aproximado de ensamble es de **1 h**.
FR - Le temps nécessaire est estimé à **1 h**.
IT - Il tempo previsto per il corretto assemblaggio è di **1 h**.



EN - Not intended for use by children.
DE - Nicht geeignet für Kinder.
ES - Producto no apto para niños.
FR - Produit non destiné à être utilisé par des enfants.
IT - Questo prodotto non è destinato all'uso da parte dei bambini.



EN - Keep away from fire or other heat sources.
DE - Bitte von Feuer und Hitzequellen fernhalten.
ES - Manténgase alejado de las llamas y otras fuentes de calor.
FR - Tenir à distance des flammes et autres sources de chaleur.
IT - Tenere lontano dal fuoco o da altre fonti di calore.



EN - We recommend wearing protective gloves.
DE - Wir empfehlen das Tragen von Schutzhandschuhen.
ES - Recomendamos el uso de guantes de seguridad.
FR - Il est recommandé de porter des gants de protection.
IT - Per il processo di assemblaggio, consigliamo fortemente l'utilizzo di guanti protettivi.

EN - Please follow the instruction manuals and use a pad to avoid damage during assembly.







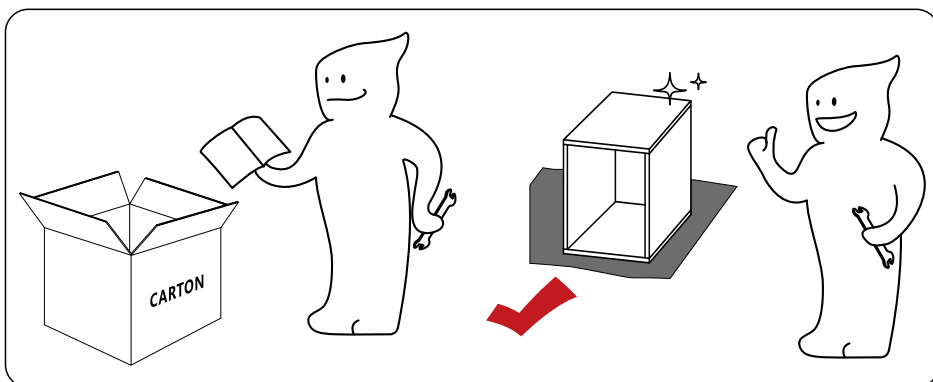
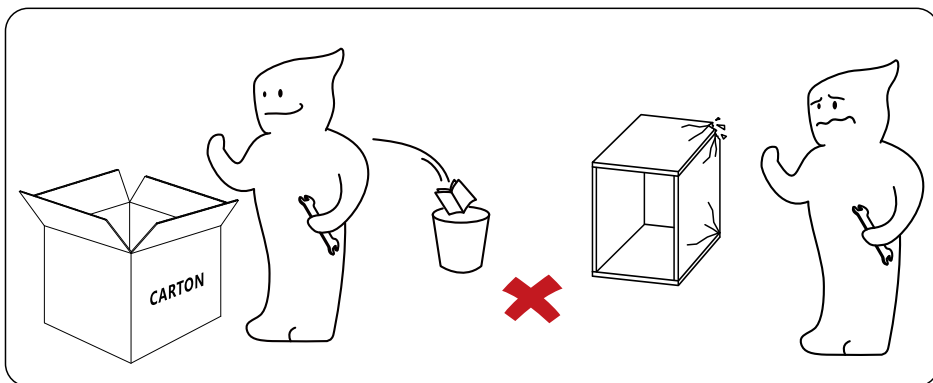

DE - Bitte folgen Sie der Anleitung und verwenden Sie eine Unterlage, um Beschädigungen bei der Montage zu vermeiden.

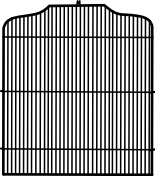
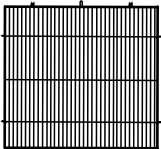
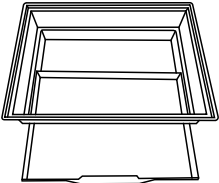
ES - Por favor siga las instrucciones del manual y utilice una cubierta o lona para proteger el producto y los suelos durante la instalación.

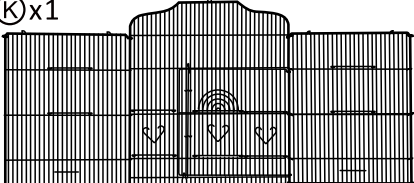
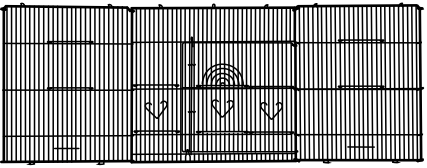
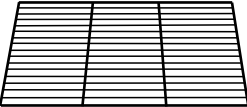

FR - Suivez les instructions de la notice et utilisez une couverture ou une bâche pour protéger le produit et les sols pendant le montage.

IT - Si prega di consultare il manuale illustrativo durante il montaggio e di utilizzare un cuscinetto per evitare possibili danni.



<p>Ⓐ x1</p> 	<p>Ⓑ x1</p> 		
<p>Ⓒ x1</p> 	<p>Ⓓ x1</p> 		
<p>Ⓔ x1</p> 	<p>Ⓕ x1</p> 	<p>Ⓖ x3</p> 	<p>Ⓗ x4</p> 
<p>Ⓙ x4</p> 	<p>Ⓝ x2</p> 	<p>Ⓚ x1</p> 	
<p>Ⓛ x1</p> 		<p>Ⓜ x1</p> 	
<p>Ⓝ x1</p> 			

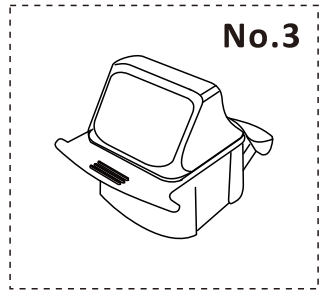
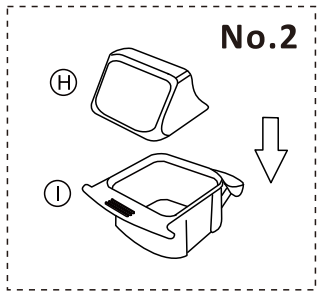
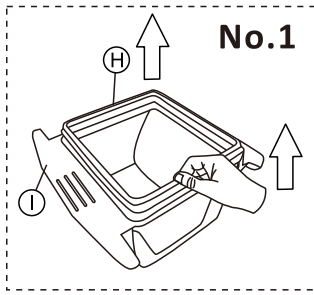

1

(H)		x1
(I)		x1





x4

2

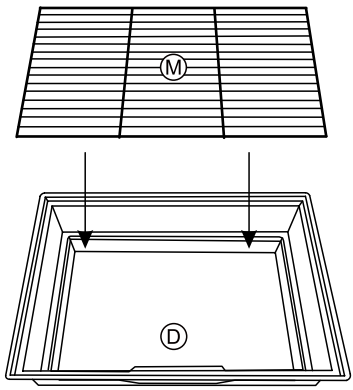
(D)		x1
(M)		x1



3

ⓐ		x1
Ⓛ		x1

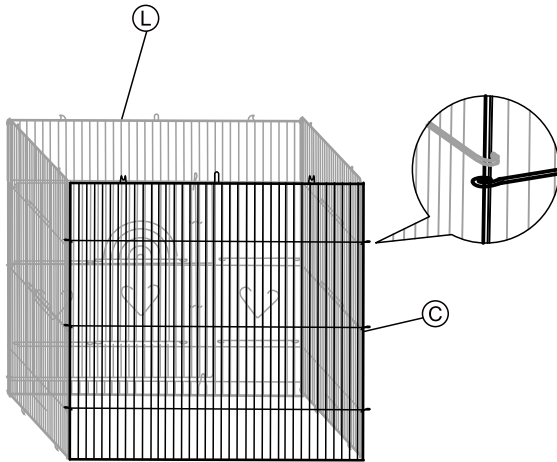

4

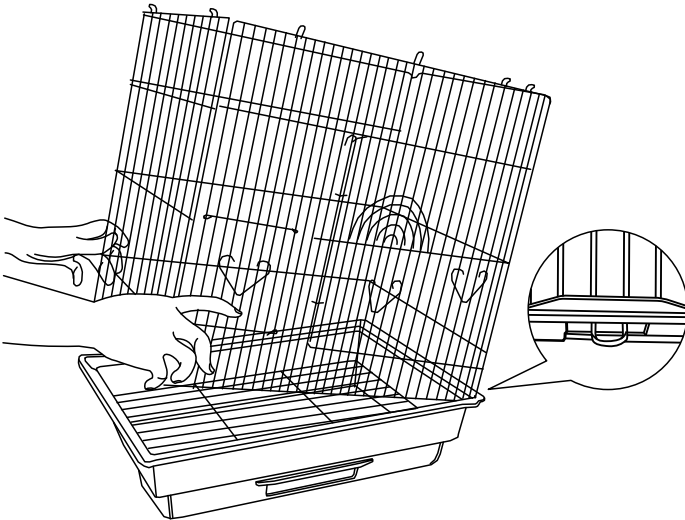

5

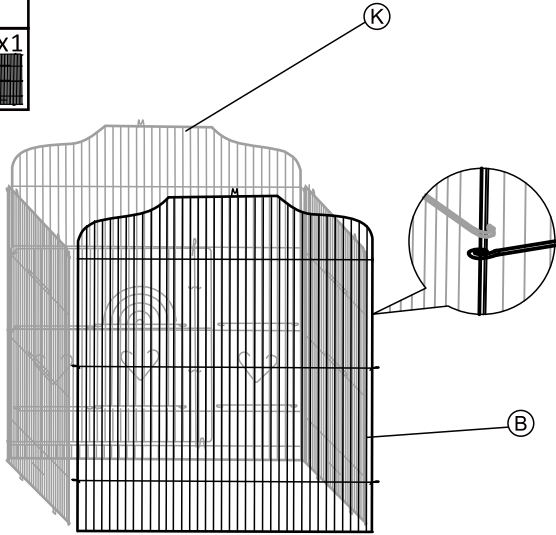
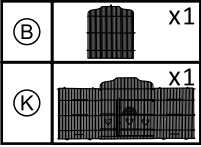

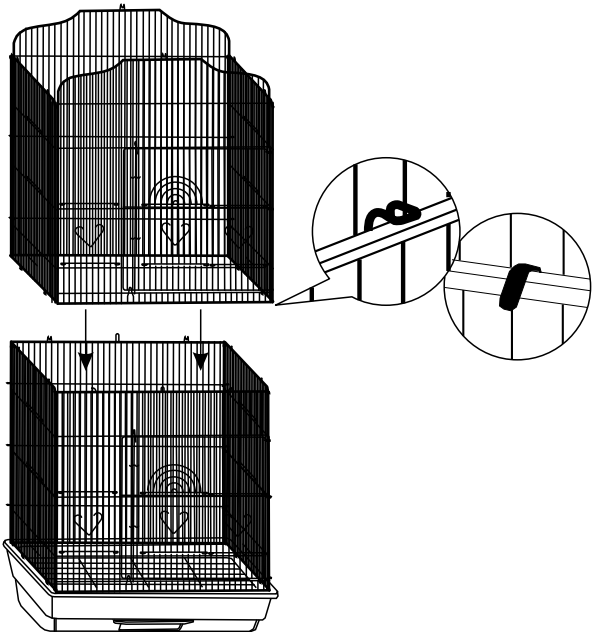

6

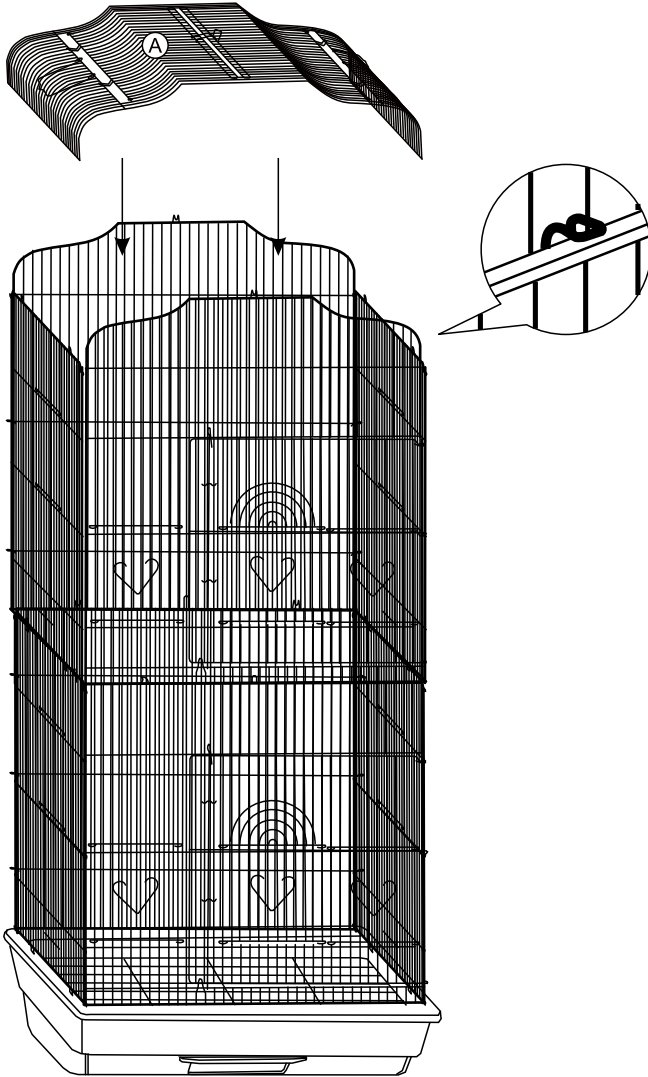

7



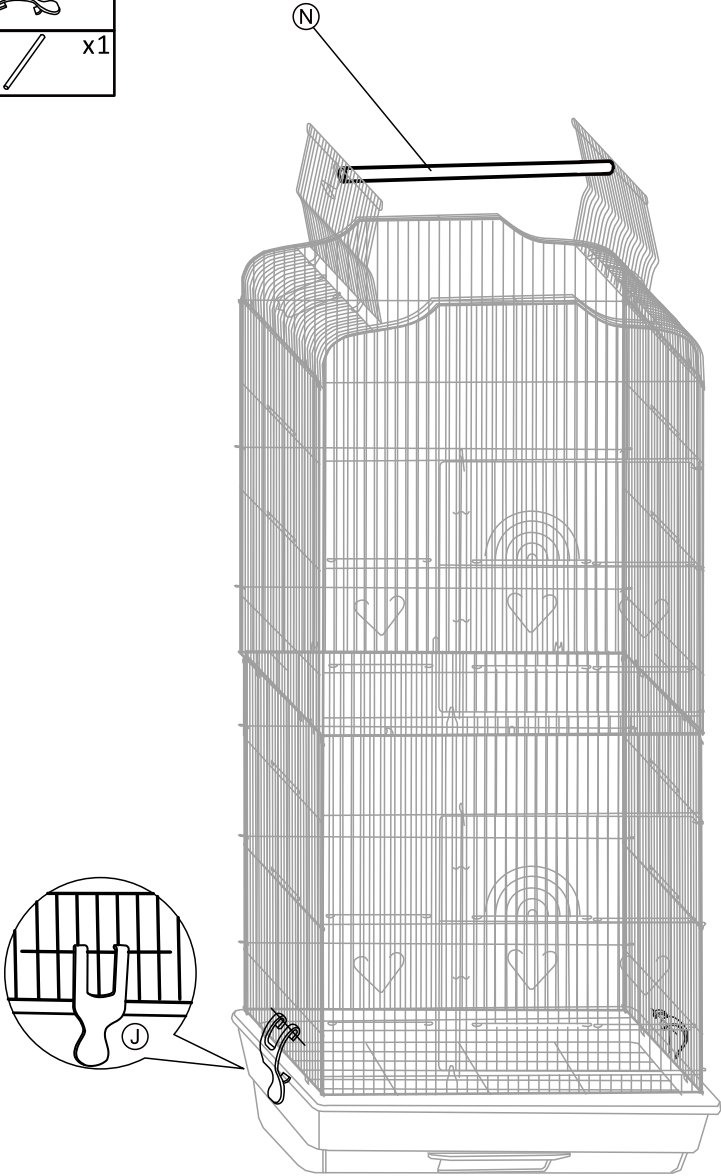

8

J	 x2
N	 x1



9

E		x1
F		x1

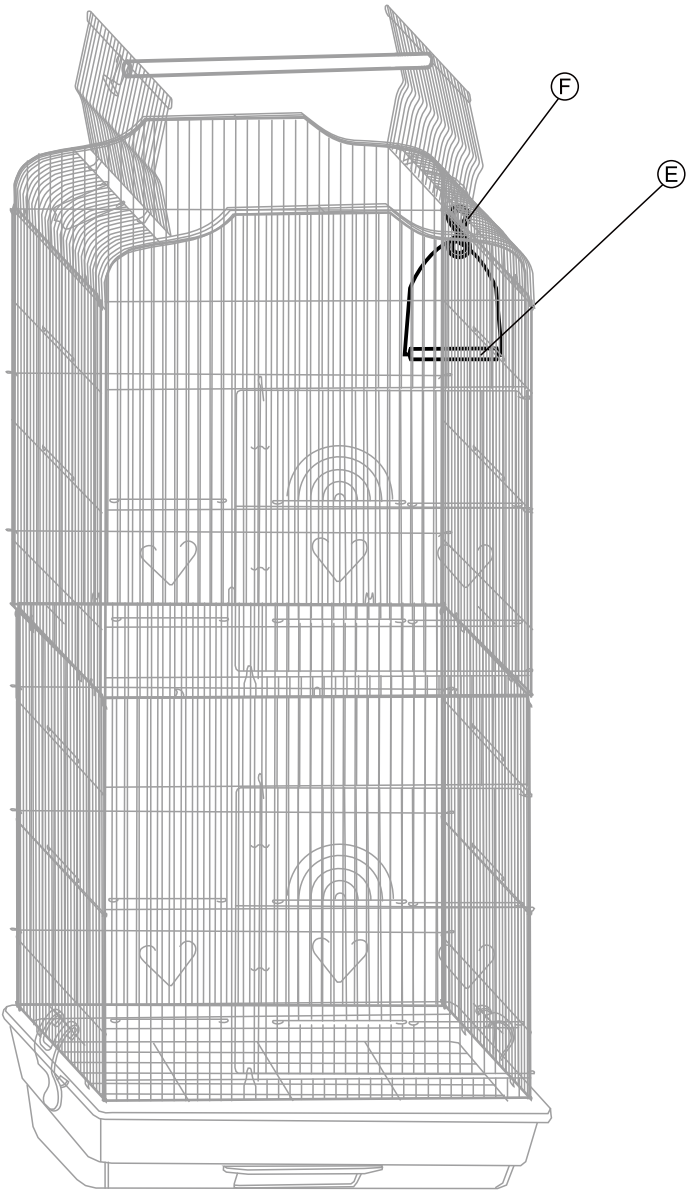

10

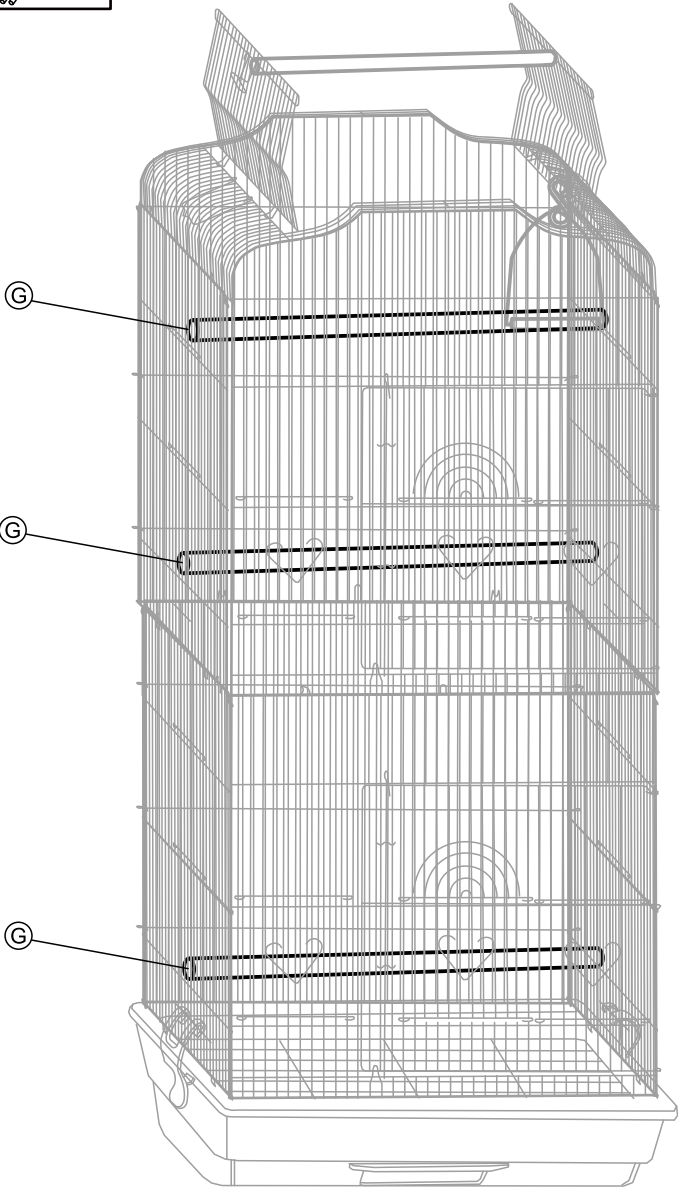
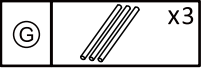

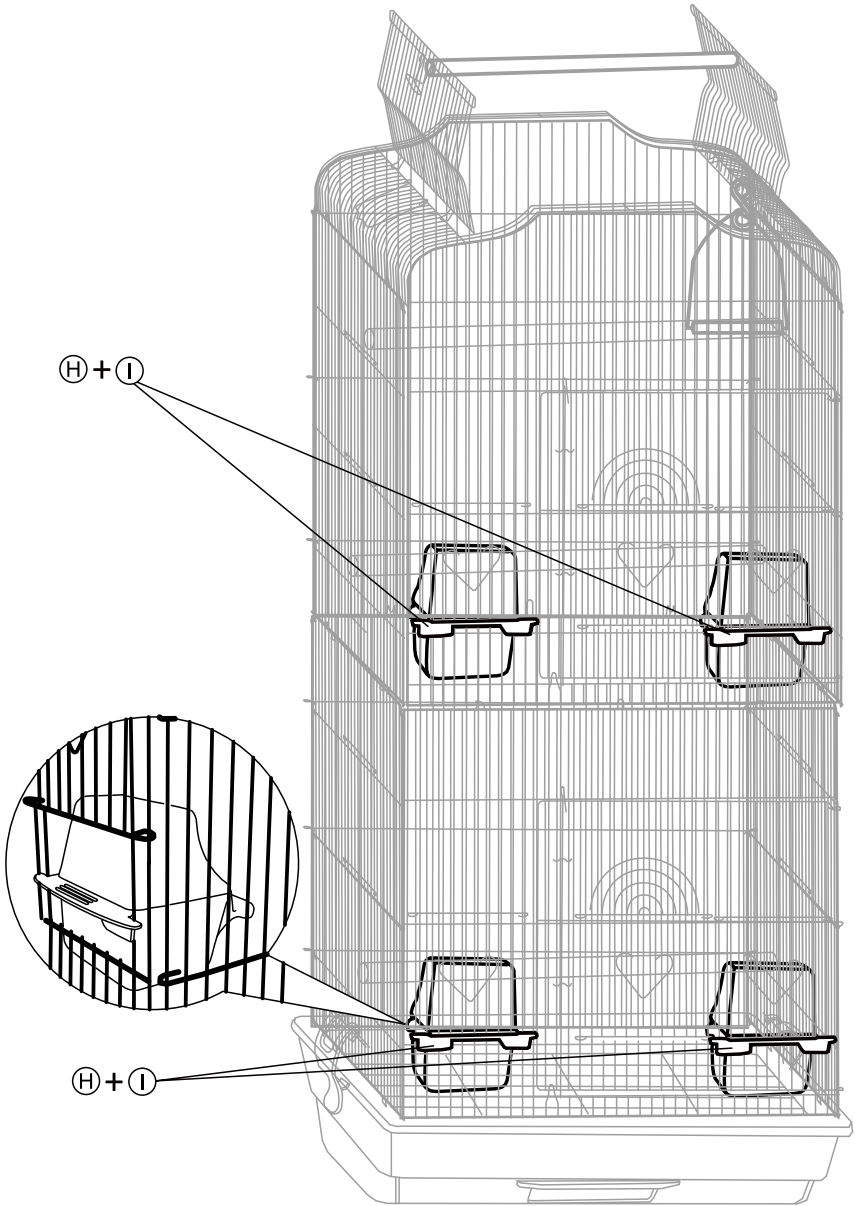

Jouw mening is erg belangrijk voor mij om meer mensen blij te maken met dit product 😊.

Als je tijd hebt 🕒, zou ik je vriendelijk willen vragen om een paar minuten de tijd te nemen om dit product te beoordelen en opmerkingen te maken om het te verbeteren en het voor meer klanten bereikbaar te maken.

Dat kan door naar je bestellingen te gaan, op het item te klikken en daaronder vind je "schrijf review". Daar kun je het product sterren ★ geven en je mening schrijven.

Alvast bedankt 🙏

En een goed dag gewenst

HMTM