



Asfora

Catalog 2020



se.com

Life Is On

Schneider
Electric



Content

| | |
|----|---|
| 4 | Asfora presentation |
| 10 | Switches |
| 12 | Push-buttons |
| 14 | Socket-outlets |
| 16 | Communication outlets |
| 18 | Rotary dimmers and USB chargers |
| 19 | Accessories |
| 20 | Technical information - Switches and push-buttons |
| 21 | Technical information - Dimmers |
| 22 | Technical information - Antenna outlets |
| 24 | Technical information - Surface-mounted boxes |
| 25 | Technical information - Dimensions |
| 26 | Reference numbers |

Asfora makes life easier

With its sleek and elegant designs, the Asfora range delivers everything today's wiring devices should.

Your customers will appreciate the ease-of-use and wide range of everyday functions offered by Asfora wiring devices, designed to be as pleasing to the touch as they are to the eye.



white, glossy



cream, glossy



bronze, painted



athracite, painted



aluminium, painted



steel, painted

6

colors

2

finishes

50+

functions



Up to 6 gangs

Whether it is for a home or small office, Asfora multi-gang cover frames are designed for easy handling during installation and a neat and tidy appearance, with several functions housed in a single unit.

Light and comfort

Help your customers get the most out of their home interiors with unique lighting ambiances for each room and each time of day.



Switch



Switch with locator lamp and icon



Dimmer



Roller blind switch

Connectivity

Help your customers to keep the digital world close at hand. They can access all media from a single jack or enjoy music from a single source throughout the home.



TV/R/SAT socket



RJ45 data socket



Loudspeaker socket

Protection

Socket outlets with shutters protect your customer from touching the metal parts under tension. IP44 products are often required in the bathroom and kitchen to protect from water splashes.



Socket outlet with lid



IP44 socket outlet with lid

New IP44 gaskets



In wet areas or conditions, switches and socket outlets must conform to strict regulatory standards, which state that they must be splash proof.

The new IP44 gasket for switches and single socket outlets has the advantage of being more universal, even on uneven surfaces. Moreover the gasket is flexible in the area of the box screws, so the screws do not need to be removed for installation. This makes installation quick and easy.



Quick and easy to install

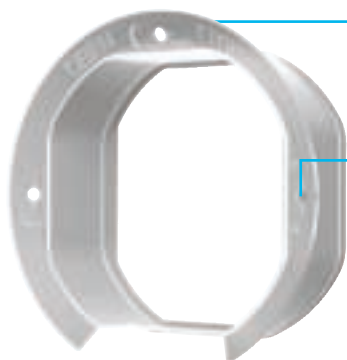

Universal shape
Also suitable for
uneven walls

Flexible in the area of
box screws
No need to remove
screws for installation

IMPROVED!

Splash proof



Asfora IP44 gasket

The new generation of inserts for switches and single socket outlets

New inserts – new and improved features!

At Schneider Electric, we listen to your feedback and understand what you need to make your daily work routine easier and more efficient. This is why we recently improved the quality and functionality of inserts for the Asfora range. The updated Asfora range now features smaller, more compact inserts, a profiled fixing frame, improved wire inlets and release buttons, and wide, profiled claws with a return spring.

NEW!

- + easy
- + fast
- + convenient

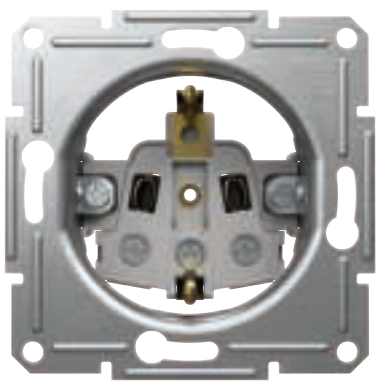

socket outlet insert

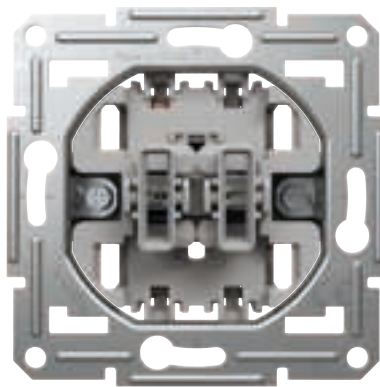

switch insert



Asfora pin earth



Asfora side earth

Smaller and more compact inserts

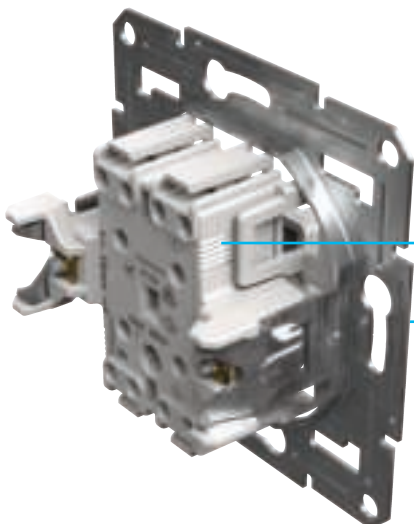

Smaller and more compact inserts

give better insert rotation on box screws, more space to manage wires in the box, and a better view inside the box

Redesigned insert shape

offers additional handling grips for better handling

Improved fixing frame and claws

For a simple, fast, and safe installation

Thanks to their redesigned mechanism the claws extend out straight and smoothly, ensuring a perfect alignment to the wall boxes during assembly. Moreover they ensure that the insert fixes securely in the box.

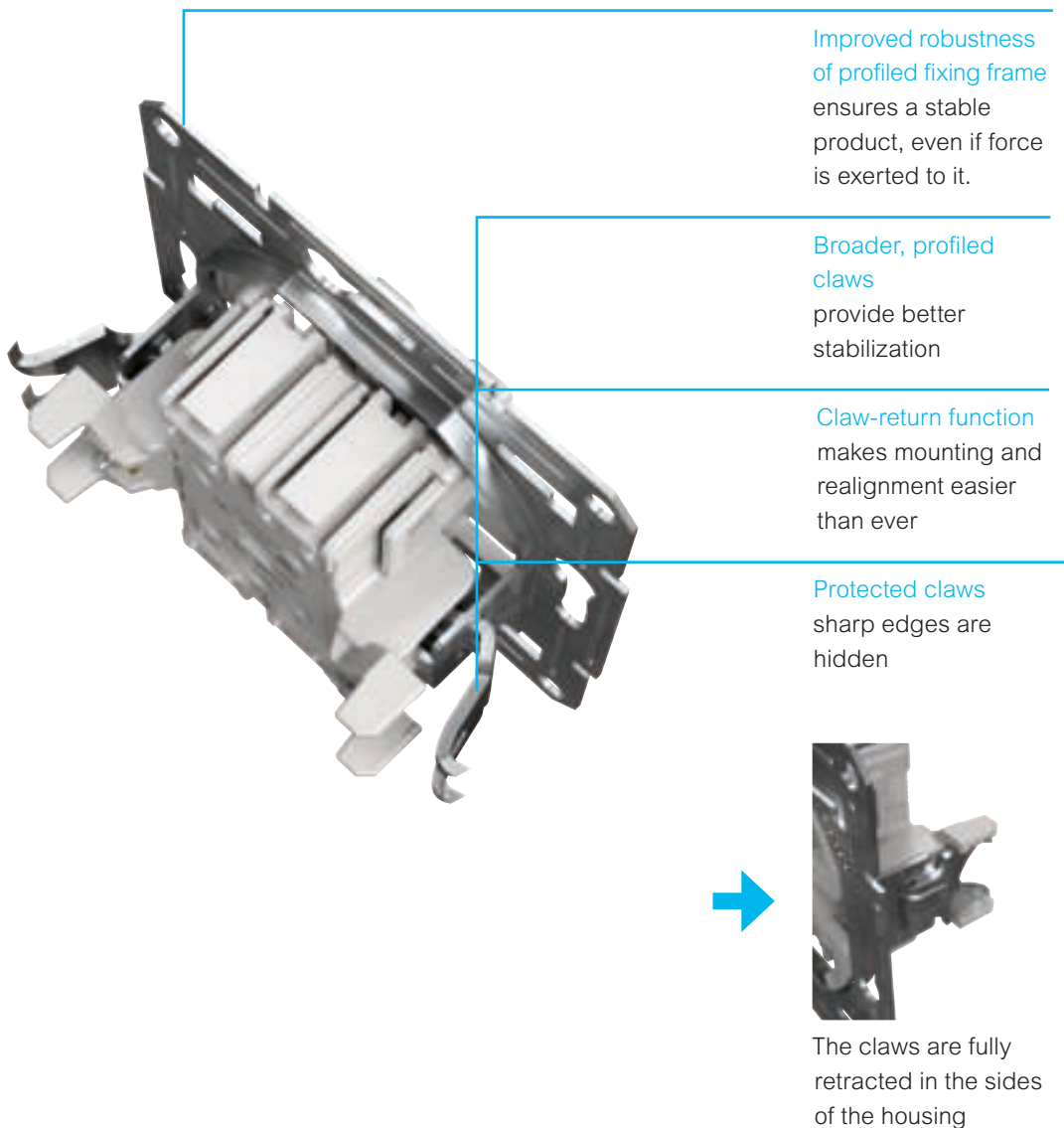

Clear connection diagram, improved wire inlets for switches, and better shaped release levers for screwless switches

Our innovative new features will make all the difference to your daily installation workflow.

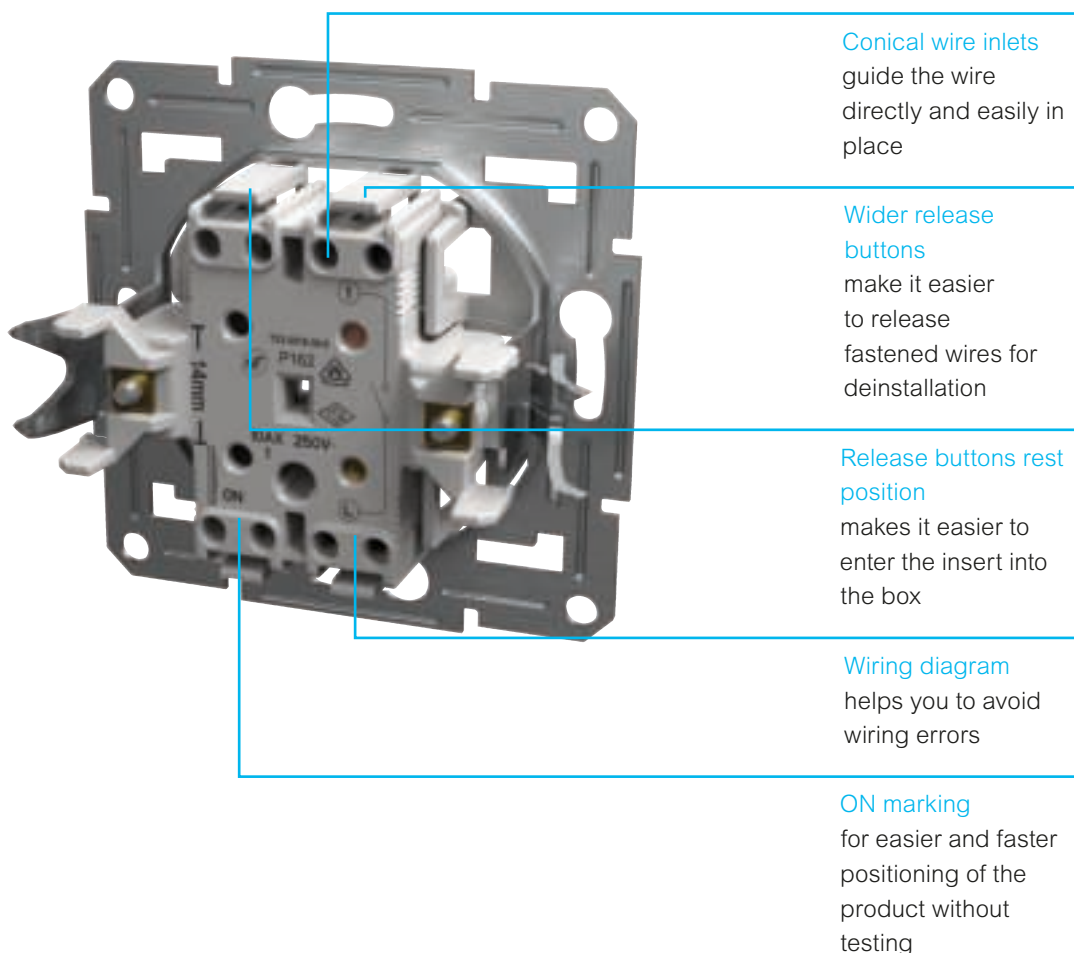

Switches - 10 AX - 250 V AC

| 1-way | 2-way | Intermediate | 2-circuit | Double 2-way | 2-pole | 3-circuit |
|-------|-------|--------------|-----------|--------------|--------|-----------|
| | | | | | | |

Screwless terminals



With cover frame

| | | | | | | | |
|--------------------------------|------------|------------|------------|------------|------------|------------|--|
| <input type="checkbox"/> white | EPH0100121 | EPH0400121 | EPH0500121 | EPH0300121 | EPH0600121 | EPH0200121 | |
| <input type="checkbox"/> cream | EPH0100123 | EPH0400123 | EPH0500123 | EPH0300123 | EPH0600123 | EPH0200123 | |



Without cover frame

| | | | | | | | |
|-------------------------------------|------------|------------|------------|------------|------------|------------|--|
| <input type="checkbox"/> white | EPH0170121 | EPH0470121 | EPH0570121 | EPH0370121 | EPH0670121 | EPH0270121 | |
| <input type="checkbox"/> cream | EPH0170123 | EPH0470123 | EPH0570123 | EPH0370123 | EPH0670123 | EPH0270123 | |
| <input type="checkbox"/> anthracite | EPH0100171 | EPH0400171 | EPH0500171 | EPH0300171 | EPH0600171 | EPH0200171 | |
| <input type="checkbox"/> steel | EPH0100162 | EPH0400162 | EPH0500162 | EPH0300162 | EPH0600162 | EPH0200162 | |
| <input type="checkbox"/> aluminium | EPH0100161 | EPH0400161 | EPH0500161 | EPH0300161 | EPH0600161 | EPH0200161 | |
| <input type="checkbox"/> bronze | EPH0100169 | EPH0400169 | EPH0500169 | EPH0300169 | EPH0600169 | EPH0200169 | |

Screw terminals



With cover frame

| | | | | | | | |
|--------------------------------|------------|------------|------------|------------|------------|------------|------------|
| <input type="checkbox"/> white | EPH0100321 | EPH0400321 | EPH0500321 | EPH0300321 | EPH0600321 | EPH0200321 | EPH2100121 |
| <input type="checkbox"/> cream | EPH0100323 | EPH0400323 | EPH0500323 | EPH0300323 | EPH0600323 | EPH0200323 | EPH2100123 |



Without cover frame

| | | | | | | | |
|-------------------------------------|------------|------------|------------|------------|------------|------------|------------|
| <input type="checkbox"/> white | | | | | | | EPH2170121 |
| <input type="checkbox"/> cream | | | | | | | EPH2170123 |
| <input type="checkbox"/> anthracite | EPH0100371 | EPH0400371 | EPH0500371 | EPH0300371 | EPH0600371 | EPH0200371 | EPH2100171 |
| <input type="checkbox"/> steel | EPH0100362 | EPH0400362 | EPH0500362 | EPH0300362 | EPH0600362 | EPH0200362 | EPH2100162 |
| <input type="checkbox"/> aluminium | EPH0100361 | EPH0400361 | EPH0500361 | EPH0300361 | EPH0600361 | EPH0200361 | EPH2100161 |
| <input type="checkbox"/> bronze | EPH0100369 | EPH0400369 | EPH0500369 | EPH0300369 | EPH0600369 | EPH0200369 | EPH2100169 |

Switches IP44 - 10 AX - 250 V AC

| 1-way | 2-way |
|-------|-------|
| | |

Screwless terminals

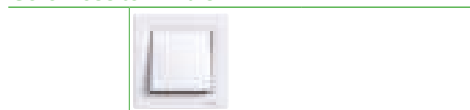

With cover frame

| | | |
|-------------------------------------|------------|------------|
| <input type="checkbox"/> white | EPH0100221 | EPH0400421 |
| <input type="checkbox"/> cream | EPH0100223 | EPH0400423 |
| <input type="checkbox"/> anthracite | EPH0100271 | EPH0400471 |
| <input type="checkbox"/> steel | EPH0100262 | EPH0400462 |
| <input type="checkbox"/> aluminium | EPH0100261 | EPH0400461 |
| <input type="checkbox"/> bronze | EPH0100269 | EPH0400469 |

Characteristics

- Maximum load for self ballasted lamps (LED, CFL, etc.):
10 AX - 250 V AC switches: 100 W
16 AX - 250 V AC switches: 200 W

Switches with locator lamp 10 AX - 250 V AC



Screwless terminals



With cover frame

| | | |
|--------------------------------|------------|------------|
| <input type="checkbox"/> white | EPH1400121 | EPH1500121 |
| <input type="checkbox"/> cream | EPH1400123 | EPH1500123 |



Without cover frame

| | | |
|-------------------------------------|------------|------------|
| <input type="checkbox"/> white | EPH1470121 | EPH1570121 |
| <input type="checkbox"/> cream | EPH1470123 | EPH1570123 |
| <input type="checkbox"/> anthracite | EPH1400171 | EPH1500171 |
| <input type="checkbox"/> steel | EPH1400162 | EPH1500162 |
| <input type="checkbox"/> aluminium | EPH1400161 | EPH1500161 |
| <input type="checkbox"/> bronze | EPH1400169 | EPH1500169 |

Screw terminals



With cover frame

| | | |
|--------------------------------|------------|------------|
| <input type="checkbox"/> white | EPH1400321 | EPH1500321 |
| <input type="checkbox"/> cream | EPH1400323 | EPH1500323 |



Without cover frame

| | | |
|-------------------------------------|------------|------------|
| <input type="checkbox"/> anthracite | EPH1400371 | EPH1500371 |
| <input type="checkbox"/> steel | EPH1400362 | EPH1500362 |
| <input type="checkbox"/> aluminium | EPH1400361 | EPH1500361 |
| <input type="checkbox"/> bronze | EPH1400369 | EPH1500369 |

Switches with locator lamp 16 AX - 250 V AC

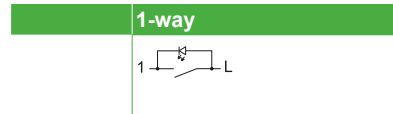

Screw terminals

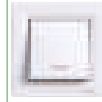

With cover frame

| | |
|--------------------------------|------------|
| <input type="checkbox"/> white | EPH1430321 |
| <input type="checkbox"/> cream | EPH1430323 |



Without cover frame

| | |
|-------------------------------------|------------|
| <input type="checkbox"/> anthracite | EPH1430371 |
| <input type="checkbox"/> steel | EPH1430362 |
| <input type="checkbox"/> aluminium | EPH1430361 |
| <input type="checkbox"/> bronze | EPH1430369 |

Roller blind switches 10 A - 250 V AC

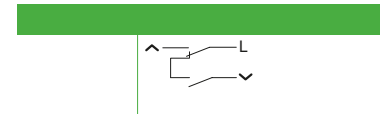

Screwless terminals

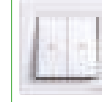

With cover frame

| | |
|--------------------------------|------------|
| <input type="checkbox"/> white | EPH1300521 |
| <input type="checkbox"/> cream | EPH1300523 |



Without cover frame

| | |
|-------------------------------------|------------|
| <input type="checkbox"/> white | EPH1370521 |
| <input type="checkbox"/> cream | EPH1370523 |
| <input type="checkbox"/> anthracite | EPH1300571 |
| <input type="checkbox"/> steel | EPH1300562 |
| <input type="checkbox"/> aluminium | EPH1300561 |
| <input type="checkbox"/> bronze | EPH1300569 |

Key card switches 10 A - 250 V AC

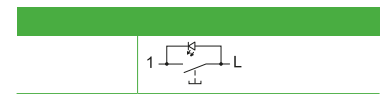

Screwless terminals



With cover frame

| | |
|--------------------------------|------------|
| <input type="checkbox"/> white | EPH6200121 |
| <input type="checkbox"/> cream | EPH6200123 |



Without cover frame

| | |
|-------------------------------------|------------|
| <input type="checkbox"/> white | EPH6270121 |
| <input type="checkbox"/> cream | EPH6270123 |
| <input type="checkbox"/> anthracite | EPH6200171 |
| <input type="checkbox"/> steel | EPH6200162 |
| <input type="checkbox"/> aluminium | EPH6200161 |
| <input type="checkbox"/> bronze | EPH6200169 |

Characteristics

- Maximum load for self ballasted lamps (LED, CFL, etc.):
 - 10 AX - 250 V AC switches: 100 W
 - 16 AX - 250 V AC switches: 200 W

Push-buttons - 10 A - 250 V AC

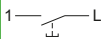
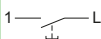
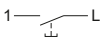
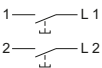
| | Single 1-way | 1-way with "bell" symbol | 1-way with "light" symbol | Double Double 1-way |
|--|---|---|---|--|
| |  |  |  |  |

Screwless terminals

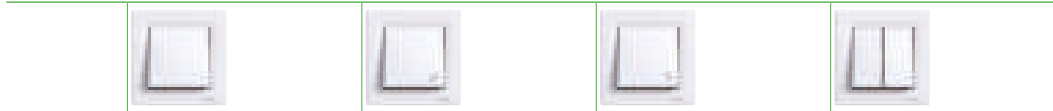

With cover frame

| | | | | |
|--------------------------------|------------|------------|------------|------------|
| <input type="checkbox"/> white | EPH0700121 | EPH0800121 | EPH0900121 | EPH1100121 |
| <input type="checkbox"/> cream | EPH0700123 | EPH0800123 | EPH0900123 | EPH1100123 |



Without cover frame

| | | | | |
|-------------------------------------|------------|------------|------------|------------|
| <input type="checkbox"/> white | EPH0770121 | EPH0870121 | EPH0970121 | EPH1170121 |
| <input type="checkbox"/> cream | EPH0770123 | EPH0870123 | EPH0970123 | EPH1170123 |
| <input type="checkbox"/> anthracite | EPH0700171 | EPH0800171 | EPH0900171 | EPH1100171 |
| <input type="checkbox"/> steel | EPH0700162 | EPH0800162 | EPH0900162 | EPH1100162 |
| <input type="checkbox"/> aluminium | EPH0700161 | EPH0800161 | EPH0900161 | EPH1100161 |
| <input type="checkbox"/> bronze | EPH0700169 | EPH0800169 | EPH0900169 | EPH1100169 |

Screw terminals

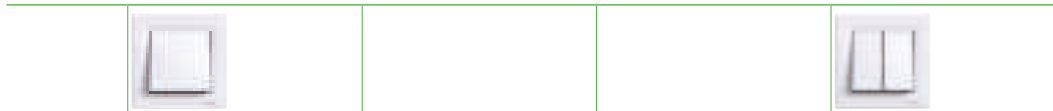

With cover frame

| | | | | |
|--------------------------------|------------|--|--|------------|
| <input type="checkbox"/> white | EPH0800321 | | | EPH1100321 |
| <input type="checkbox"/> cream | EPH0800323 | | | EPH1100323 |

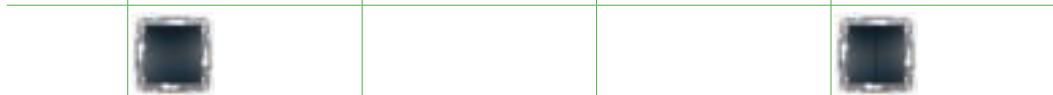

Without cover frame

| | | | | |
|-------------------------------------|------------|--|--|------------|
| <input type="checkbox"/> anthracite | EPH0800371 | | | EPH1100371 |
| <input type="checkbox"/> steel | EPH0800362 | | | EPH1100362 |
| <input type="checkbox"/> aluminium | EPH0800361 | | | EPH1100361 |
| <input type="checkbox"/> bronze | EPH0800369 | | | EPH1100369 |

Push-buttons with locator lamp 10 A - 250 V AC

| 1-way | 1-way with "bell" symbol | 1-way with "light" symbol | 1-way with "stairs" symbol |
|-------|--------------------------|---------------------------|----------------------------|
| | | | |

Screwless terminals



With cover frame

| | | | | |
|--------------------------------|------------|------------|------------|------------|
| <input type="checkbox"/> white | EPH1600121 | EPH1700121 | EPH1800121 | EPH1900121 |
| <input type="checkbox"/> cream | EPH1600123 | EPH1700123 | EPH1800123 | EPH1900123 |



Without cover frame

| | | | | |
|-------------------------------------|------------|------------|------------|------------|
| <input type="checkbox"/> white | EPH1670121 | EPH1770121 | EPH1870121 | |
| <input type="checkbox"/> cream | EPH1670123 | EPH1770123 | EPH1870123 | |
| <input type="checkbox"/> anthracite | EPH1600171 | EPH1700171 | EPH1800171 | EPH1900171 |
| <input type="checkbox"/> steel | EPH1600162 | EPH1700162 | EPH1800162 | EPH1900162 |
| <input type="checkbox"/> aluminium | EPH1600161 | EPH1700161 | EPH1800161 | EPH1900161 |
| <input type="checkbox"/> bronze | EPH1600169 | EPH1700169 | EPH1800169 | EPH1900169 |

Screw terminals



With cover frame

| | | | | |
|--------------------------------|------------|------------|--|------------|
| <input type="checkbox"/> white | EPH1600321 | EPH1700321 | | EPH1900321 |
| <input type="checkbox"/> cream | EPH1600323 | EPH1700323 | | EPH1900323 |



Without cover frame

| | | | | |
|-------------------------------------|------------|------------|--|------------|
| <input type="checkbox"/> anthracite | EPH1600371 | EPH1700371 | | EPH1900371 |
| <input type="checkbox"/> steel | EPH1600362 | EPH1700362 | | EPH1900362 |
| <input type="checkbox"/> aluminium | EPH1600361 | EPH1700361 | | EPH1900361 |
| <input type="checkbox"/> bronze | EPH1600369 | EPH1700369 | | EPH1900369 |

Roller blind push-buttons 10 A - 250 V AC

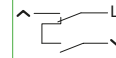

Screwless terminals



With cover frame

| | |
|--------------------------------|------------|
| <input type="checkbox"/> white | EPH1300121 |
| <input type="checkbox"/> cream | EPH1300123 |



Without cover frame

| | |
|-------------------------------------|------------|
| <input type="checkbox"/> white | EPH1370121 |
| <input type="checkbox"/> cream | EPH1370123 |
| <input type="checkbox"/> anthracite | EPH1300171 |
| <input type="checkbox"/> steel | EPH1300162 |
| <input type="checkbox"/> aluminium | EPH1300161 |
| <input type="checkbox"/> bronze | EPH1300169 |

Screw terminals



With cover frame

| | |
|--------------------------------|------------|
| <input type="checkbox"/> white | EPH1300321 |
| <input type="checkbox"/> cream | EPH1300323 |



Without cover frame

| | |
|-------------------------------------|------------|
| <input type="checkbox"/> anthracite | EPH1300371 |
| <input type="checkbox"/> steel | EPH1300362 |
| <input type="checkbox"/> aluminium | EPH1300361 |
| <input type="checkbox"/> bronze | EPH1300369 |

Push-buttons - 12 V AC with locator lamp and label holder

1-way

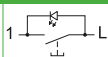





Screwless terminals

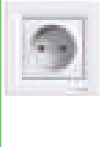

With cover frame

| | |
|--------------------------------|------------|
| <input type="checkbox"/> white | EPH1601521 |
| <input type="checkbox"/> cream | EPH1601523 |

Socket-outlets - 2P - 16 A - 250 V AC

| | Single | Double ^[*] | Double PL standard ^[*] |
|--|---|---|---|
| Screw terminals | | | |
| |  |  |  |
| With cover frame | | | |
| <input type="checkbox"/> white | EPH3000121 | EPH9700121 ^[*] | EPH9700221 ^[*] |
| <input type="checkbox"/> cream | EPH3000123 | EPH9700123 ^[*] | EPH9700223 ^[*] |
| <input checked="" type="checkbox"/> anthracite | | EPH9700171 ^[*] | EPH9700271 ^[*] |
| <input checked="" type="checkbox"/> steel | | EPH9700162 ^[*] | EPH9700262 ^[*] |
| <input type="checkbox"/> aluminium | | EPH9700161 ^[*] | EPH9700261 ^[*] |
| <input type="checkbox"/> bronze | | EPH9700169 ^[*] | EPH9700269 ^[*] |
| |  | | |
| Without cover frame | | | |
| <input checked="" type="checkbox"/> anthracite | EPH3000171 | | |
| <input checked="" type="checkbox"/> steel | EPH3000162 | | |
| <input type="checkbox"/> aluminium | EPH3000161 | | |
| <input type="checkbox"/> bronze | EPH3000169 | | |









^[*] Not compatible with frame system.

Socket-outlets - 2P+E (pin earth) - 16 A - 250 V AC

| | Single | Single with shutters | Single with shutters and lid IP44 | Single with shutters and lid IP44 ^[*] | Single with red center plate | Double CZ, SK standards ^[*] | Double PL standard |
|--|---|---|---|---|--|---|---|
| Screw terminals | | | | | | | |
| |  |  |  |  |  |  |  |
| With cover frame | | | | | | | |
| <input type="checkbox"/> white | EPH2800121 | EPH2800221 | EPH2800621 | EPH2800321 ^[*] | EPH2800421 | EPH9800121 ^[*] | EPH9800221 ^[*] |
| <input type="checkbox"/> cream | EPH2800123 | EPH2800223 | EPH2800623 | EPH2800323 ^[*] | EPH2800423 | EPH9800123 ^[*] | EPH9800223 ^[*] |
| <input checked="" type="checkbox"/> anthracite | | | | EPH2800371 ^[*] | | EPH9800171 ^[*] | EPH9800271 ^[*] |
| <input checked="" type="checkbox"/> steel | | | | EPH2800362 ^[*] | | EPH9800162 ^[*] | EPH9800262 ^[*] |
| <input type="checkbox"/> aluminium | | | | EPH2800361 ^[*] | | EPH9800161 ^[*] | EPH9800261 ^[*] |
| <input type="checkbox"/> bronze | | | | EPH2800369 ^[*] | | EPH9800169 ^[*] | EPH9800269 ^[*] |
| |  |  |  | | | |  |
| Without cover frame | | | | | | | |
| <input type="checkbox"/> white | EPH2870121 | | | | | | EPH9810221 |
| <input type="checkbox"/> cream | EPH2870123 | | | | | | EPH9810223 |
| <input checked="" type="checkbox"/> anthracite | EPH2800171 | EPH2800271 | EPH2800671 | | | | EPH9810271 |
| <input checked="" type="checkbox"/> steel | EPH2800162 | EPH2800262 | EPH2800662 | | | | EPH9810262 |
| <input type="checkbox"/> aluminium | EPH2800161 | EPH2800261 | EPH2800661 | | | | EPH9810261 |
| <input type="checkbox"/> bronze | EPH2800169 | EPH2800269 | EPH2800669 | | | | EPH9810269 |
| <input checked="" type="checkbox"/> red | EPH2870442 | | | | | | |

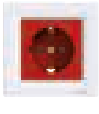
^[*] Not compatible with frame system.

Socket-outlets - 2P+E (side earth) - 16 A - 250 V AC

| | Single | Single with shutters | Single with lid | Single with shutters and lid IP44 ^[*] | Single with shutters and red center plate | Double ^[*] |
|-------------------------------------|---|---|---|---|---|---|
| Screw terminals | | | | | | |
| |  |  |  |  |  |  |
| With cover frame | | | | | | |
| <input type="checkbox"/> white | EPH2900121 | EPH2900221 | EPH3100121 | EPH3100321 ^[*] | EPH2900521 | EPH9900121 ^[*] |
| <input type="checkbox"/> cream | EPH2900123 | EPH2900223 | EPH3100123 | EPH3100323 ^[*] | EPH2900523 | EPH9900123 ^[*] |
| <input type="checkbox"/> anthracite | | | | EPH3100371 ^[*] | | EPH9900171 ^[*] |
| <input type="checkbox"/> steel | | | | EPH3100362 ^[*] | | EPH9900162 ^[*] |
| <input type="checkbox"/> aluminium | | | | EPH3100361 ^[*] | | EPH9900161 ^[*] |
| <input type="checkbox"/> bronze | | | | EPH3100369 ^[*] | | EPH9900169 ^[*] |
| |  |  |  | | | |
| Without cover frame | | | | | | |
| <input type="checkbox"/> white | EPH2970121 | EPH2970221 | EPH3170121 | | | |
| <input type="checkbox"/> cream | EPH2970123 | EPH2970223 | EPH3170123 | | | |
| <input type="checkbox"/> anthracite | EPH2900171 | EPH2900271 | EPH3100171 | | | |
| <input type="checkbox"/> steel | EPH2900162 | EPH2900262 | EPH3100162 | | | |
| <input type="checkbox"/> aluminium | EPH2900161 | EPH2900261 | EPH3100161 | | | |
| <input type="checkbox"/> bronze | EPH2900169 | EPH2900269 | EPH3100169 | | | |
| <input type="checkbox"/> red | | EPH2970542 | | | | |

[*] Not compatible with frame system.

Cable outlets

Screw terminals



With cover frame

| | |
|--------------------------------|------------|
| <input type="checkbox"/> white | EPH5500121 |
| <input type="checkbox"/> cream | EPH5500123 |



Without cover frame

| | |
|-------------------------------------|------------|
| <input type="checkbox"/> white | |
| <input type="checkbox"/> cream | |
| <input type="checkbox"/> anthracite | EPH5500171 |
| <input type="checkbox"/> steel | EPH5500162 |
| <input type="checkbox"/> aluminium | EPH5500161 |
| <input type="checkbox"/> bronze | EPH5500169 |

Communication outlets

Antenna outlets

| Ending (1 dB) | | | | | | |
|--|------------|-------------------|--------------|-----------------------|------------------|------------|
| | TV | TV-R | TV-SAT | TV-R-SAT | TV-SAT-SAT | SAT |
| Type of connector | IEC Male | IEC Male + Female | IEC Male + F | IEC Male + Female + F | IEC Male + F + F | F |
| | | | | | | |
| With cover frame | | | | | | |
| <input type="checkbox"/> white | EPH3200121 | EPH3300121 | EPH3400121 | EPH3500121 | EPH3600121 | EPH3700121 |
| <input type="checkbox"/> cream | EPH3200123 | EPH3300123 | EPH3400123 | EPH3500123 | EPH3600123 | EPH3700123 |
| | | | | | | |
| Without cover frame | | | | | | |
| <input type="checkbox"/> white | EPH3270121 | EPH3300721 | EPH3470121 | | EPH3670121 | EPH3770121 |
| <input type="checkbox"/> cream | EPH3270123 | EPH3300723 | EPH3470123 | | EPH3670123 | EPH3770123 |
| <input checked="" type="checkbox"/> anthracite | EPH3200171 | EPH3300171 | EPH3400171 | EPH3500171 | EPH3600171 | EPH3700171 |
| <input checked="" type="checkbox"/> steel | EPH3200162 | EPH3300162 | EPH3400162 | EPH3500162 | EPH3600162 | EPH3700162 |
| <input type="checkbox"/> aluminium | EPH3200161 | EPH3300161 | EPH3400161 | EPH3500161 | EPH3600161 | EPH3700161 |
| <input checked="" type="checkbox"/> bronze | EPH3200169 | EPH3300169 | EPH3400169 | EPH3500169 | EPH3600169 | EPH3700169 |



| Individual (1 dB) | |
|--|------------|
| Type of connector | TV-SAT |
| | |
| With cover frame | |
| <input type="checkbox"/> white | EPH3400421 |
| <input type="checkbox"/> cream | EPH3400423 |
| | |
| Without cover frame | |
| <input checked="" type="checkbox"/> anthracite | EPH3400471 |
| <input checked="" type="checkbox"/> steel | EPH3400462 |
| <input type="checkbox"/> aluminium | EPH3400461 |
| <input checked="" type="checkbox"/> bronze | EPH3400469 |

| Intermediate (4 dB) | | | | | | |
|--|------------|------------|------------|------------|--|------------|
| | TV | TV-R | TV-SAT | TV-R-SAT | | SAT |
| | | | | | | |
| With cover frame | | | | | | |
| <input type="checkbox"/> white | EPH3200221 | EPH3300221 | EPH3400221 | EPH3500221 | | EPH3700221 |
| <input type="checkbox"/> cream | EPH3200223 | EPH3300223 | EPH3400223 | EPH3500223 | | EPH3700223 |
| | | | | | | |
| Without cover frame | | | | | | |
| <input checked="" type="checkbox"/> anthracite | EPH3200271 | EPH3300271 | EPH3400271 | EPH3500271 | | EPH3700271 |
| <input checked="" type="checkbox"/> steel | EPH3200262 | EPH3300262 | EPH3400262 | EPH3500262 | | EPH3700262 |
| <input type="checkbox"/> aluminium | EPH3200261 | EPH3300261 | EPH3400261 | EPH3500261 | | EPH3700261 |
| <input checked="" type="checkbox"/> bronze | EPH3200269 | EPH3300269 | EPH3400269 | EPH3500269 | | EPH3700269 |

| Intermediate (8 dB) | | | | |
|--|------------|------------|------------|------------|
| | TV | TV-R | TV-SAT | TV-R-SAT |
| | | | | |
| With cover frame | | | | |
| <input type="checkbox"/> white | EPH3200321 | EPH3300321 | EPH3400321 | EPH3500321 |
| <input type="checkbox"/> cream | EPH3200323 | EPH3300323 | EPH3400323 | EPH3500323 |
| | | | | |
| Without cover frame | | | | |
| <input type="checkbox"/> white | EPH3270321 | | EPH3470321 | |
| <input type="checkbox"/> cream | EPH3270323 | | EPH3470323 | |
| <input checked="" type="checkbox"/> anthracite | EPH3200371 | EPH3300371 | EPH3400371 | EPH3500371 |
| <input checked="" type="checkbox"/> steel | EPH3200362 | EPH3300362 | EPH3400362 | EPH3500362 |
| <input type="checkbox"/> aluminium | EPH3200361 | EPH3300361 | EPH3400361 | EPH3500361 |
| <input checked="" type="checkbox"/> bronze | EPH3200369 | EPH3300369 | EPH3400369 | EPH3500369 |

Communication outlets

Data and telephone outlets

| | Single RJ11 | RJ45 Cat.5e UTP | RJ45 Cat.5e STP | RJ45 Cat.6 UTP | | |
|-------------------------------------|---|---|---|---|---|---|
| Terminals | Screw | IDC | IDC | IDC | | |
| |  |  |  |  | | |
| With cover frame | | | | | | |
| <input type="checkbox"/> white | EPH4100121 | EPH4300121 | EPH5000121 | EPH4700121 | | |
| <input type="checkbox"/> cream | EPH4100123 | EPH4300123 | EPH5000123 | EPH4700123 | | |
| |  |  |  |  | | |
| Without cover frame | | | | | | |
| <input type="checkbox"/> white | EPH4170121 | EPH4370121 | | EPH4770121 | | |
| <input type="checkbox"/> cream | EPH4170123 | EPH4370123 | | EPH4770123 | | |
| <input type="checkbox"/> anthracite | EPH4100171 | EPH4300171 | EPH5000171 | EPH4700171 | | |
| <input type="checkbox"/> steel | EPH4100162 | EPH4300162 | EPH5000162 | EPH4700162 | | |
| <input type="checkbox"/> aluminium | EPH4100161 | EPH4300161 | EPH5000161 | EPH4700161 | | |
| <input type="checkbox"/> bronze | EPH4100169 | EPH4300169 | EPH5000169 | EPH4700169 | | |
| | Double RJ11 | RJ45 Cat.5e UTP | | RJ45 Cat.6 UTP | RJ45 + RJ11 Cat.6 UTP | RJ45 + RJ12 Cat.5e UTP |
| Terminals | Screw | IDC | | IDC | IDC - Screw | IDC |
| |  |  | |  |  |  |
| With cover frame | | | | | | |
| <input type="checkbox"/> white | EPH4200121 | EPH4400121 | | EPH4800121 | EPH5200121 | EPH4900121 |
| <input type="checkbox"/> cream | EPH4200123 | EPH4400123 | | EPH4800123 | EPH5200123 | EPH4900123 |
| |  |  | |  |  |  |
| Without cover frame | | | | | | |
| <input type="checkbox"/> white | EPH4270121 | EPH4470121 | | EPH4870121 | EPH5270121 | |
| <input type="checkbox"/> cream | EPH4270123 | EPH4470123 | | EPH4870123 | EPH5270123 | |
| <input type="checkbox"/> anthracite | EPH4200171 | EPH4400171 | | EPH4800171 | EPH5200171 | EPH4900171 |
| <input type="checkbox"/> steel | EPH4200162 | EPH4400162 | | EPH4800162 | EPH5200162 | EPH4900162 |
| <input type="checkbox"/> aluminium | EPH4200161 | EPH4400161 | | EPH4800161 | EPH5200161 | EPH4900161 |
| <input type="checkbox"/> bronze | EPH4200169 | EPH4400169 | | EPH4800169 | EPH5200169 | EPH4900169 |

Loudspeaker outlets

Double loudspeaker outlets

Screwless terminals



With cover frame

| | |
|--------------------------------|------------|
| <input type="checkbox"/> white | EPH5700121 |
| <input type="checkbox"/> cream | EPH5700123 |









Without cover frame

| | |
|-------------------------------------|------------|
| <input type="checkbox"/> white | EPH5770121 |
| <input type="checkbox"/> cream | EPH5770123 |
| <input type="checkbox"/> anthracite | EPH5700171 |
| <input type="checkbox"/> steel | EPH5700162 |
| <input type="checkbox"/> aluminium | EPH5700161 |
| <input type="checkbox"/> bronze | EPH5700169 |



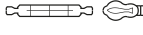
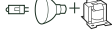
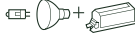

Rotary dimmers and USB chargers

Rotary dimmers - 230 V AC







| | 600 VA, 2-way | 600 VA, 2-way with locator lamp ⁽¹⁾ | 315 VA, 2-way |
|---|---|---|--|
| Screw terminals (pillar type) | | | |
| |  |  |  |
| With cover frame | | | |
| <input type="checkbox"/> white | EPH6400121 | EPH6500121 | EPH6600121 |
| <input type="checkbox"/> cream | EPH6400123 | EPH6500123 | EPH6600123 |
| |  |  |  |
| Without cover frame | | | |
| <input type="checkbox"/> white | EPH6470121 | EPH6570121 | EPH6670121 |
| <input type="checkbox"/> cream | EPH6470123 | EPH6570123 | EPH6670123 |
| <input type="checkbox"/> anthracite | EPH6400171 | EPH6500171 | EPH6600171 |
| <input type="checkbox"/> steel | EPH6400162 | EPH6500162 | EPH6600162 |
| <input type="checkbox"/> aluminium | EPH6400161 | EPH6500161 | EPH6600161 |
| <input type="checkbox"/> bronze | EPH6400169 | EPH6500169 | EPH6600169 |
| Others characteristics | | | |
| Short-circuit protection | Fuse F6, 3 AH - 250 V | | Electronic |
| Loads | | | |
| 230 V AC incandescent lamps  | 40-600 W | 40-600 W | 20-315 W |
| 230 V AC halogen lamps  | 40-600 W | 40-600 W | 20-315 W |
| LV halogen lamps with ferromagnetic transformer  | 40-600 VA | 40-600 VA | - |
| LV halogen lamps with electronic transformer  | - | - | 20-315 VA |



(1) Locator lamp is under the rotary control button.

USB chargers

| | Double USB charger type A, 2.1 A or 2 x 1.05 A | Double USB charger type A + C, 2.4 A or 2 x 1.2 A |
|-------------------------------------|---|---|
| |  |  |
| With cover frame | | |
| <input type="checkbox"/> white | EPH2700221 | EPH2700321 |
| <input type="checkbox"/> cream | EPH2700223 | EPH2700323 |
| |  |  |
| Without cover frame | | |
| <input type="checkbox"/> anthracite | EPH2700271 | EPH2700371 |
| <input type="checkbox"/> steel | EPH2700262 | EPH2700362 |
| <input type="checkbox"/> aluminium | EPH2700261 | EPH2700361 |
| <input type="checkbox"/> bronze | EPH2700269 | EPH2700369 |

Cover frames

| | 1 gang | 2 gang | 3 gang | 4 gang | 5 gang | 6 gang |
|-------------------------------------|---|---|---|--|--|--|
| Horizontal | | | | | | |
| |  |  |  |  |  |  |
| <input type="checkbox"/> white | EPH5800121 | EPH5800221 | EPH5800321 | EPH5800421 | EPH5800521 | EPH5800621 |
| <input type="checkbox"/> cream | EPH5800123 | EPH5800223 | EPH5800323 | EPH5800423 | EPH5800523 | EPH5800623 |
| <input type="checkbox"/> anthracite | EPH5800171 | EPH5800271 | EPH5800371 | EPH5800471 | EPH5800571 | EPH5800671 |
| <input type="checkbox"/> steel | EPH5800162 | EPH5800262 | EPH5800362 | EPH5800462 | EPH5800562 | EPH5800662 |
| <input type="checkbox"/> aluminium | EPH5800161 | EPH5800261 | EPH5800361 | EPH5800461 | EPH5800561 | EPH5800661 |
| <input type="checkbox"/> bronze | EPH5800169 | EPH5800269 | EPH5800369 | EPH5800469 | EPH5800569 | EPH5800669 |

| | 2 gang | 3 gang |
|-------------------------------------|--|--|
| Vertical | | |
| |  |  |
| <input type="checkbox"/> white | EPH5810221 | EPH5810321 |
| <input type="checkbox"/> cream | EPH5810223 | EPH5810323 |
| <input type="checkbox"/> anthracite | EPH5810271 | EPH5810371 |
| <input type="checkbox"/> steel | EPH5810262 | EPH5810362 |
| <input type="checkbox"/> aluminium | EPH5810261 | EPH5810361 |
| <input type="checkbox"/> bronze | EPH5810269 | EPH5810369 |

Surface-mounted boxes

| | 1 gang | Extension multi-gang |
|--------------------------------------|---|---|
| Screwless and screw terminals | | |
| |  |  |
| <input type="checkbox"/> white | EPH6100121 | EPH6100221 |
| <input type="checkbox"/> cream | EPH6100123 | EPH6100223 |
| <input type="checkbox"/> anthracite | EPH6100171 | EPH6100271 |
| <input type="checkbox"/> steel | EPH6100162 | EPH6100262 |
| <input type="checkbox"/> aluminium | EPH6100161 | EPH6100261 |
| <input type="checkbox"/> bronze | EPH6100169 | EPH6100269 |

Blind covers

| | |
|---|------------|
|  | |
| With cover frame | |
| <input type="checkbox"/> white | EPH5600121 |
| <input type="checkbox"/> cream | EPH5600123 |
|  | |
| Without cover frame | |
| <input type="checkbox"/> white | EPH5670121 |
| <input type="checkbox"/> cream | EPH5670123 |
| <input type="checkbox"/> anthracite | EPH5600171 |
| <input type="checkbox"/> steel | EPH5600162 |
| <input type="checkbox"/> aluminium | EPH5600161 |
| <input type="checkbox"/> bronze | EPH5600169 |

Technical information

Switches and push-buttons

Connection examples

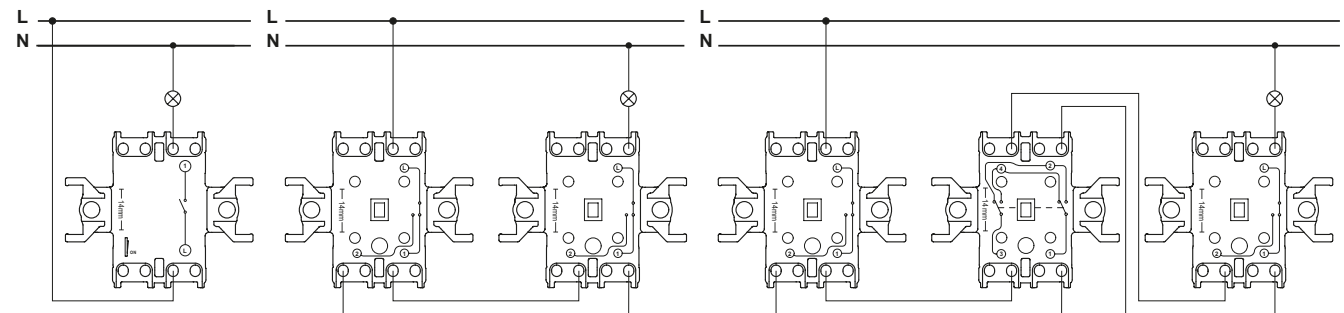

1-way switch

Two 2-way switches

Two 2-way switches + 1 intermediate switch

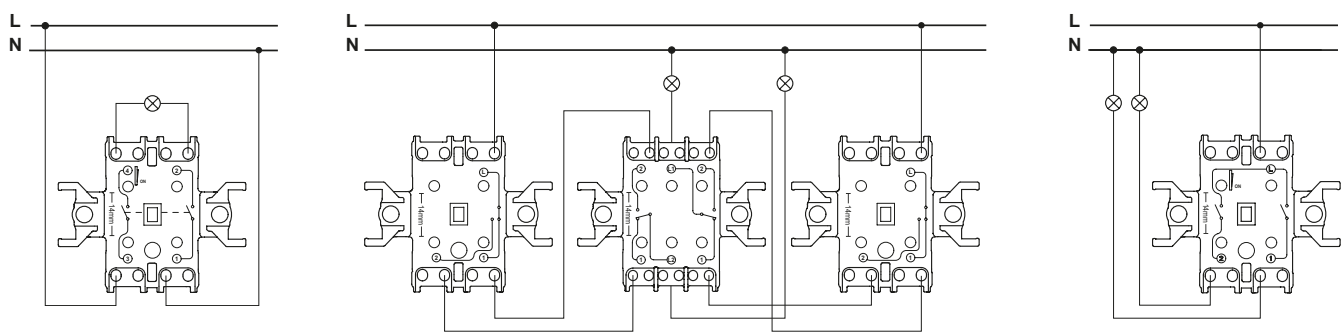

2-pole switch

Two 2-way switches + one double 2-way switch acting on two different loads

2-circuit switch

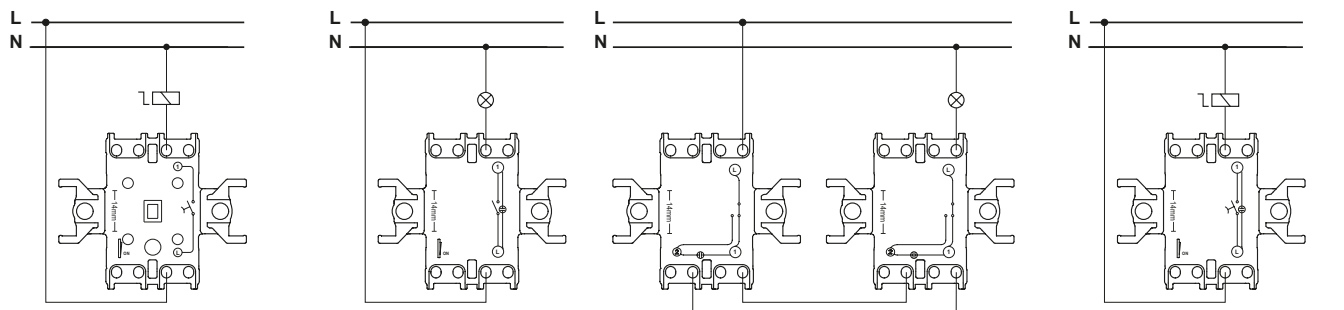

Push-button

1-way switch with locator lamp

Two 2-way switches with locator lamps

Push-button with locator lamp

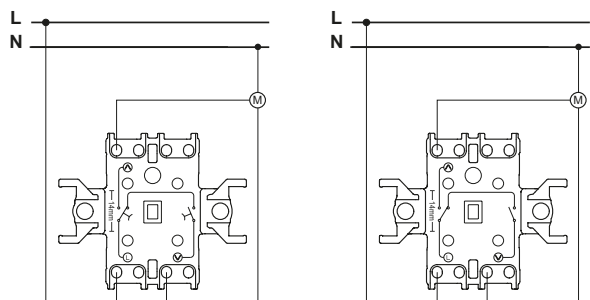

Roller blind push-button

Roller blind switch

Technical information

Dimmers

Rotary electronic dimmer

Installation

You must reduce the maximum allowed load due to the decreased heat dissipation when the device is not mounted into a single standard flushmounted mounting box.

| Load reduction by | Mounted in cavity walls ⁽¹⁾ | Several installed together in combination ⁽¹⁾ | In 1-gang or 2-gang surface-mounted housing | In 3-gang surface-mounted housing |
|-------------------|--|--|---|-----------------------------------|
| 25 % | ■ | ■ | | |
| 30 % | | | ■ | |
| 50 % | | | | ■ |

(1) If several factors apply, add the load reductions together.

Connections

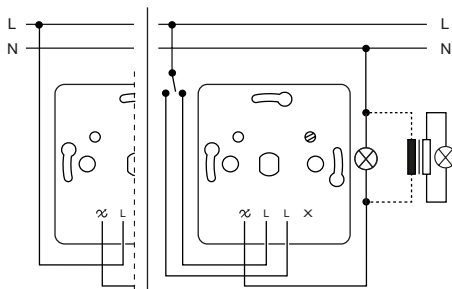

2-way switches – EPH64001xx - EPH65001xx

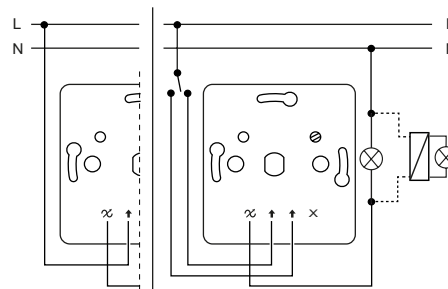

2-way switch – EPH66001xx

Substitution examples

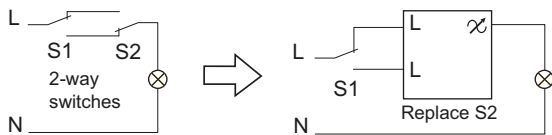
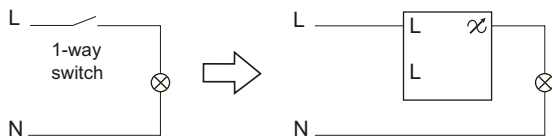

Technical information

Antenna outlets

| Type | | TV | | | TV-R | | |
|--------------------------|--------|--------------------------|-------------------|--------------------------|--------------------------|-------------------|-------------------|
| | | Ending 1 dB | Intermediate 4 dB | Intermediate 8 dB | Ending 1 dB | Intermediate 4 dB | Intermediate 8 dB |
| | | EPH32001xx EPH32701xx | EPH32002xx | EPH32003xx EPH32703xx | EPH33001xx EPH33007xx | EPH33002xx | EPH33003xx |
| Loss | dB | 1 | 4 | 8 | 1 | 4 | 8 |
| Operating Frequency | SAT | MHz | - | - | - | - | - |
| | TV/VHF | | 5-862 | 5-862 | 5-862 | 118-470 | 118-470 |
| | TV/UHF | | 5-862 | 5-862 | 5-862 | 470-830 | 470-830 |
| | R | | - | - | - | 10-108 | 10-108 |
| Pass through attenuation | SAT | dB | - | - | - | - | - |
| | TV/VHF | | 1 | 4 | 8 | 1.5 | 3.7 |
| | TV/UHF | | 1 | 4 | 8 | 2.8 | 4.6 |
| | R | | - | - | - | 11.1 | 9.3 |
| Outlet attenuation | dB | 1 | 4 | 8 | 0.5 | 0.5 | 0.5 |
| DC Current | | - | - | - | - | - | - |
| Outlets/line | | - | - | - | 1 | 4 | 4 |

| Type | | TV-SAT | | | | TV-R-SAT | | |
|--------------------------|--------|--------------------------|-------------------|--------------------------|-----------------|---------------|-------------------|-------------------|
| | | Ending 1 db | Intermediate 4 dB | Intermediate 8 dB | Individual 1 dB | Ending 1 db | Intermediate 4 dB | Intermediate 8 dB |
| | | EPH34001xx EPH34701xx | EPH34002xx | EPH34003xx EPH34703xx | EPH34004xx | EPH35001xx | EPH35002xx | EPH35003xx |
| Loss | dB | 1 | 4 | 8 | 1 | 1 | 4 | 8 |
| Operating Frequency | SAT | MHz | 950-2400 | 950-2400 | 950-2400 | 950-2400 | 950-2400 | 950-2400 |
| | TV/VHF | | 118-470 | 118-470 | 118-470 | 118-470 | 118-470 | 118-470 |
| | TV/UHF | | 470-830 | 470-830 | 470-830 | 470-830 | 470-830 | 470-830 |
| | R | | - | - | - | 10-108 | 10-108 | 10-108 |
| Pass through attenuation | SAT | dB | 13 | 12.1 | 10.3 | 13 | 4.1 | 4.2 |
| | TV/VHF | | 2.2 | 4.5 | 10.8 | 2.2 | 1.5 | 4.9 |
| | TV/UHF | | 1 | 4.8 | 12.3 | 1 | 2.7 | 5.1 |
| | R | | - | - | - | 14.8 | 16.8 | 15.2 |
| Outlet attenuation | dB | - | 0.5 | 0.5 | - | - | 0.5 | 0.5 |
| DC Current | | in SAT outlet | in SAT outlet | in SAT outlet | in SAT outlet | in SAT outlet | in SAT outlet | in SAT outlet |
| Outlets/line | | 1 | 4 | 4 | 1 | 1 | 4 | 4 |

| Type | | TV-SAT-SAT | SAT | |
|--------------------------|--------|--------------------------|--------------------------|-------------------|
| | | Ending 1 dB | Ending 1 db | Intermediate 4 dB |
| | | EPH36001xx EPH36701xx | EPH37001xx EPH37701xx | EPH37002xx |
| Loss | dB | 1 | 1 | 4 |
| Operating Frequency | SAT | MHz | 950-2400 | 950-2400 |
| | TV/VHF | | 118-470 | 118-470 |
| | TV/UHF | | 470-830 | 470-830 |
| | R | | - | 10-108 |
| Pass through attenuation | SAT | dB | 13 | 4.1 |
| | TV/VHF | | 2.2 | 1.5 |
| | TV/UHF | | 1 | 2.7 |
| | R | | - | 14.8 |
| Outlet attenuation | dB | - | - | 0.5 |
| DC Current | | in SAT outlet | in SAT outlet | in SAT outlet |
| Outlets/line | | 1 | 1 | 4 |

Only one of the outlets in "Ending TV / R outlet" can also be used as individual one.

Only the cable connected outlet in "Individual TV / SAT outlet" can be used as ending one in linear installation.

Technical information

Antenna outlets

TV/R applications

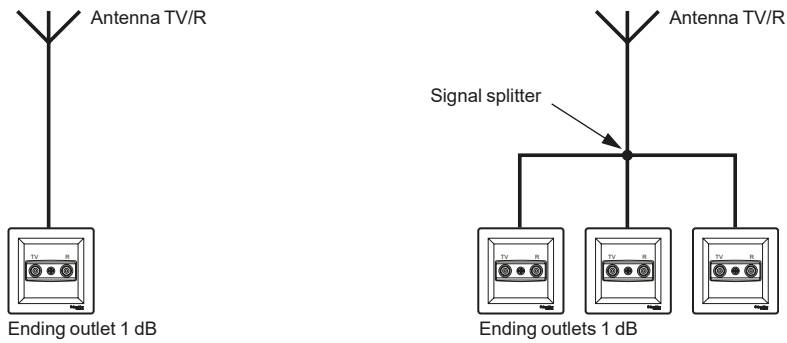

Linear installation inserts intermediate 4 dB, 8 dB and end of line 1 dB (always in the end)

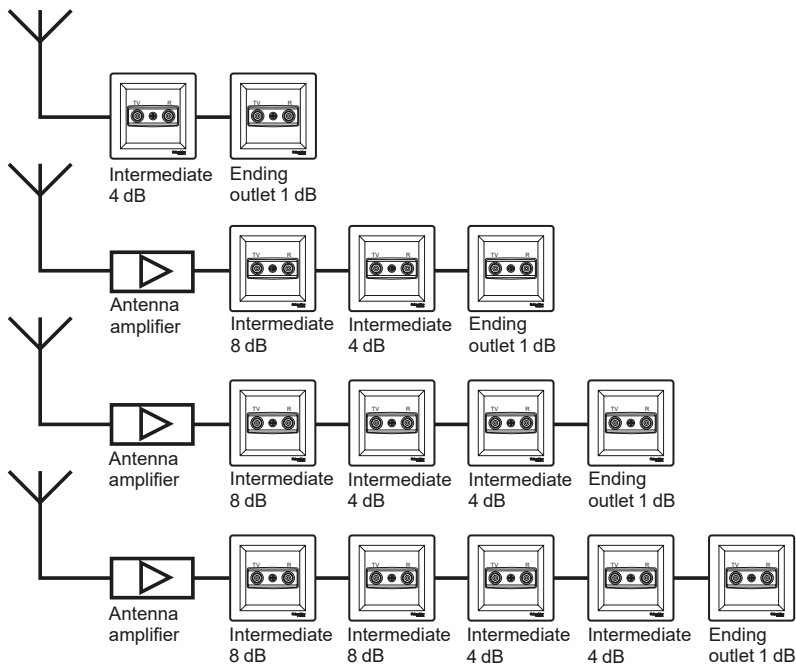

Technical information

Surface-mounted boxes

1 gang mounting

(EPH61001xx)

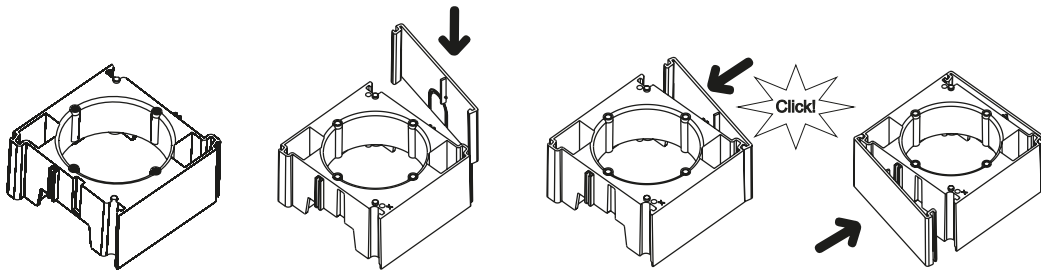

Multi-gang mounting

(EPH61001xx + EPH61002xx)

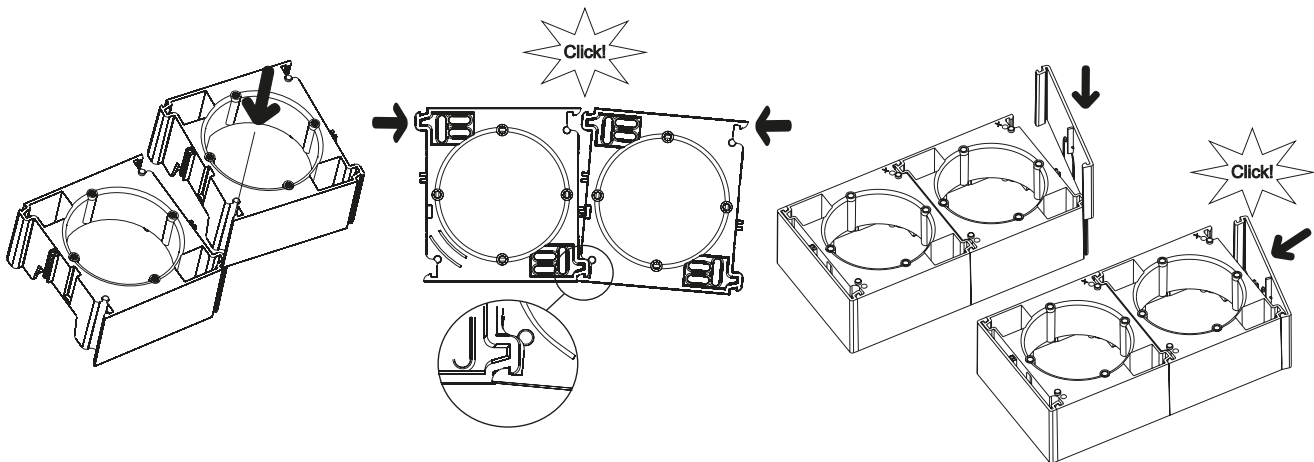

Mounting with TV/R, TV/SAT, TV/R/SAT outlets

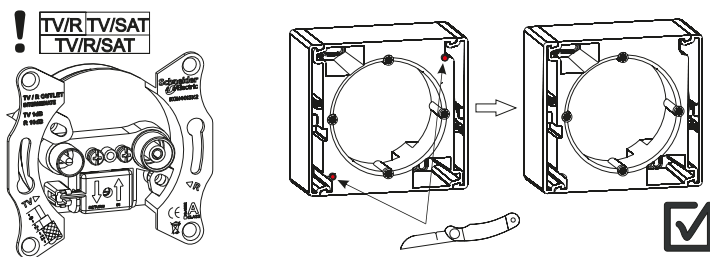

Technical information

Dimensions

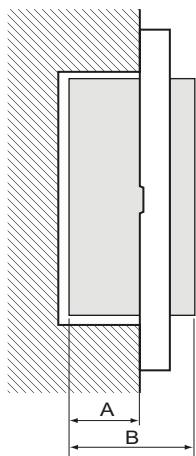

A: Embedding depth
B: Depth

| Ref. | A (mm) | B (mm) | Ref. | A (mm) | B (mm) | Ref. | A (mm) | B (mm) | Ref. | A (mm) | B (mm) |
|------------|--------|--------|------------|--------|--------|------------|--------|--------|------------|--------|--------|
| EPH01001xx | 28 | 43 | EPH13001xx | 28 | 43 | EPH29005xx | 32 | 42 | EPH41001xx | 29 | 38 |
| EPH01002xx | 28 | 43 | EPH13003xx | 28 | 43 | EPH30001xx | 32 | 42 | EPH42001xx | 29 | 38 |
| EPH01003xx | 28 | 43 | EPH13005xx | 28 | 43 | EPH31001xx | 32 | 47 | EPH43001xx | 27 | 36 |
| EPH02001xx | 28 | 43 | EPH14001xx | 28 | 43 | EPH31003xx | 32 | 42 | EPH44001xx | 27 | 36 |
| EPH02003xx | 28 | 43 | EPH14003xx | 28 | 43 | EPH32001xx | 28 | 38 | EPH47001xx | 27 | 36 |
| EPH03001xx | 28 | 43 | EPH14303xx | 28 | 43 | EPH32002xx | 28 | 38 | EPH48001xx | 27 | 36 |
| EPH03003xx | 28 | 43 | EPH15001xx | 28 | 43 | EPH32003xx | 28 | 38 | EPH49001xx | 27 | 36 |
| EPH04001xx | 28 | 43 | EPH15003xx | 28 | 43 | EPH33001xx | 28 | 38 | EPH50001xx | 39 | 48 |
| EPH04003xx | 28 | 43 | EPH16001xx | 28 | 43 | EPH33002xx | 28 | 38 | EPH56001xx | 26 | 35 |
| EPH04004xx | 28 | 43 | EPH16003xx | 28 | 43 | EPH33003xx | 28 | 38 | EPH57001xx | 26 | 43 |
| EPH05001xx | 28 | 43 | EPH17001xx | 28 | 43 | EPH34001xx | 29 | 42 | EPH62001xx | 29 | 52 |
| EPH05003xx | 28 | 43 | EPH17003xx | 28 | 43 | EPH34002xx | 29 | 42 | EPH63001xx | 29 | 52 |
| EPH06001xx | 28 | 43 | EPH18001xx | 28 | 43 | EPH34003xx | 29 | 42 | EPH64001xx | 29 | 49 |
| EPH06003xx | 28 | 43 | EPH19003xx | 28 | 43 | EPH34004xx | 29 | 42 | EPH65001xx | 29 | 49 |
| EPH07001xx | 28 | 43 | EPH28001xx | 32 | 42 | EPH35001xx | 29 | 42 | EPH66001xx | 29 | 49 |
| EPH08001xx | 28 | 43 | EPH28002xx | 32 | 42 | EPH35002xx | 29 | 42 | EPH97001xx | 23 | 46 |
| EPH08003xx | 28 | 43 | EPH28003xx | 32 | 48 | EPH35003xx | 29 | 42 | EPH97002xx | 23 | 46 |
| EPH09001xx | 28 | 43 | EPH28004xx | 32 | 42 | EPH36001xx | 29 | 42 | EPH98001xx | 23 | 46 |
| EPH11001xx | 28 | 43 | EPH29001xx | 32 | 42 | EPH37001xx | 29 | 42 | EPH98002xx | 23 | 46 |
| EPH11003xx | 28 | 43 | EPH29002xx | 32 | 42 | EPH37002xx | 29 | 42 | EPH99001xx | 23 | 46 |

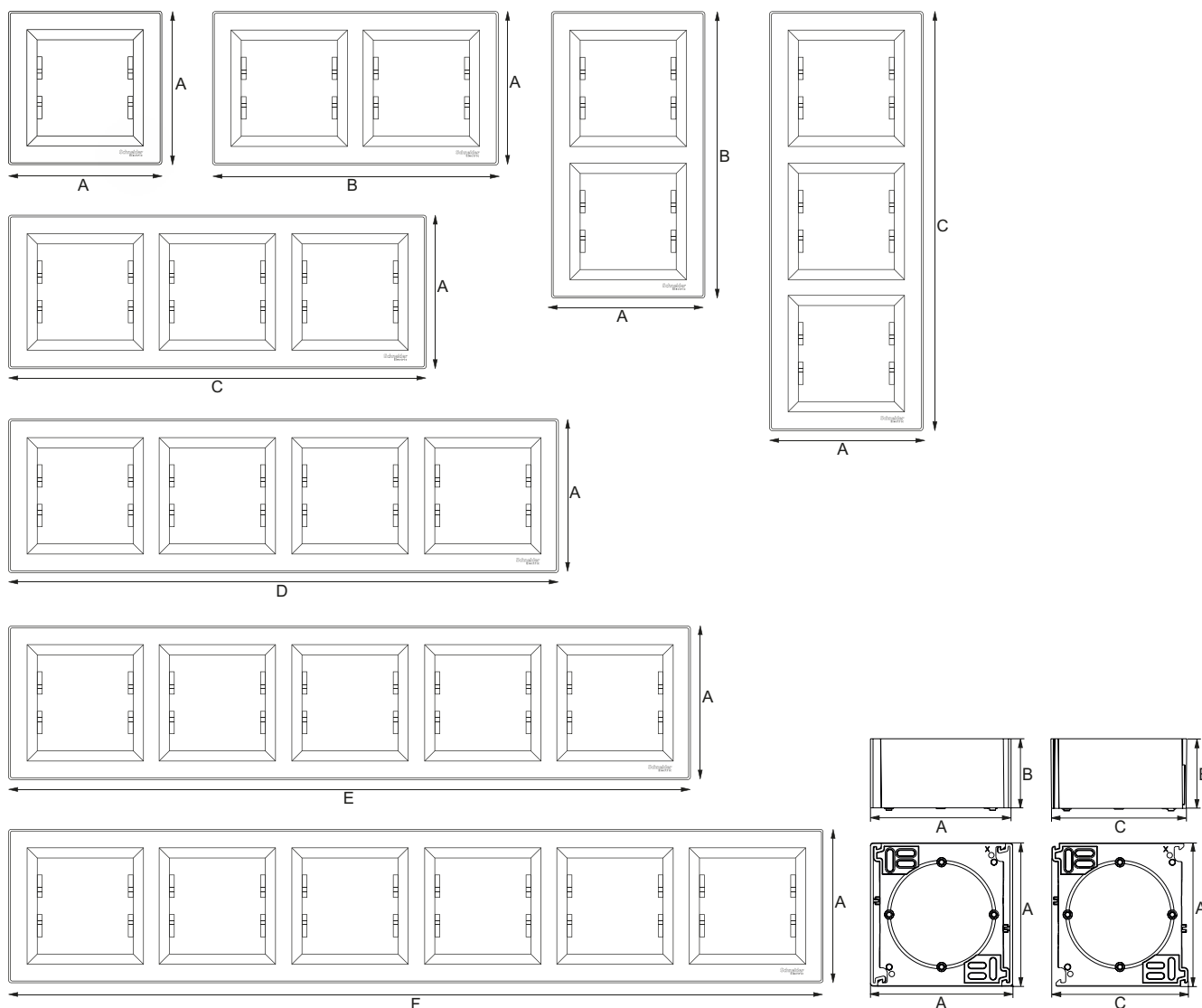

Horizontal and vertical frames (mm)

| 1 gang | 2 gang | 3 gang | 4 gang | 5 gang | 6 gang |
|--------|--------|--------|--------|--------|--------|
| A | B | C | D | E | F |
| 83 | 154 | 225 | 296 | 367 | 439 |

Surface-mounted boxes (mm)

| 1 gang | Extension | | | |
|--------|-----------|----|----|----|
| A | B | A | B | C |
| 82 | 40 | 82 | 40 | 78 |

Reference numbers

Overview

| Ref. | Pages | Ref. | Pages | Ref. | Pages | Ref. | Pages | Ref. | Pages |
|------------|-------|------------|-------|------------|-------|------------|-------|------------|-------|
| EPH0100121 | 10 | EPH0400462 | 10 | EPH1100121 | 12 | EPH1500323 | 11 | EPH2170121 | 10 |
| EPH0100123 | 10 | EPH0400469 | 10 | EPH1100123 | 12 | EPH1500361 | 11 | EPH2170123 | 10 |
| EPH0100161 | 10 | EPH0400471 | 10 | EPH1100161 | 12 | EPH1500362 | 11 | EPH2700221 | 18 |
| EPH0100162 | 10 | EPH0470121 | 10 | EPH1100162 | 12 | EPH1500369 | 11 | EPH2700223 | 18 |
| EPH0100169 | 10 | EPH0470123 | 10 | EPH1100169 | 12 | EPH1500371 | 11 | EPH2700261 | 18 |
| EPH0100171 | 10 | EPH0500121 | 10 | EPH1100171 | 12 | EPH1570121 | 11 | EPH2700262 | 18 |
| EPH0100221 | 10 | EPH0500123 | 10 | EPH1100321 | 12 | EPH1570123 | 11 | EPH2700269 | 18 |
| EPH0100223 | 10 | EPH0500161 | 10 | EPH1100323 | 12 | EPH1600121 | 13 | EPH2700271 | 18 |
| EPH0100261 | 10 | EPH0500162 | 10 | EPH1100361 | 12 | EPH1600123 | 13 | EPH2700321 | 18 |
| EPH0100262 | 10 | EPH0500169 | 10 | EPH1100362 | 12 | EPH1600161 | 13 | EPH2700323 | 18 |
| EPH0100269 | 10 | EPH0500171 | 10 | EPH1100369 | 12 | EPH1600162 | 13 | EPH2700361 | 18 |
| EPH0100271 | 10 | EPH0500321 | 10 | EPH1100371 | 12 | EPH1600169 | 13 | EPH2700362 | 18 |
| EPH0100321 | 10 | EPH0500323 | 10 | EPH1170121 | 12 | EPH1600171 | 13 | EPH2700369 | 18 |
| EPH0100323 | 10 | EPH0500361 | 10 | EPH1170123 | 12 | EPH1600321 | 13 | EPH2700371 | 18 |
| EPH0100361 | 10 | EPH0500362 | 10 | EPH1300121 | 13 | EPH1600323 | 13 | EPH2800121 | 14 |
| EPH0100362 | 10 | EPH0500369 | 10 | EPH1300123 | 13 | EPH1600361 | 13 | EPH2800123 | 14 |
| EPH0100369 | 10 | EPH0500371 | 10 | EPH1300161 | 13 | EPH1600362 | 13 | EPH2800161 | 14 |
| EPH0100371 | 10 | EPH0570121 | 10 | EPH1300162 | 13 | EPH1600369 | 13 | EPH2800162 | 14 |
| EPH0170121 | 10 | EPH0570123 | 10 | EPH1300169 | 13 | EPH1600371 | 13 | EPH2800169 | 14 |
| EPH0170123 | 10 | EPH0600121 | 10 | EPH1300171 | 13 | EPH1601521 | 13 | EPH2800171 | 14 |
| EPH0200121 | 10 | EPH0600123 | 10 | EPH1300321 | 13 | EPH1601523 | 13 | EPH2800221 | 14 |
| EPH0200123 | 10 | EPH0600161 | 10 | EPH1300323 | 13 | EPH1670121 | 13 | EPH2800223 | 14 |
| EPH0200161 | 10 | EPH0600162 | 10 | EPH1300361 | 13 | EPH1670123 | 13 | EPH2800261 | 14 |
| EPH0200162 | 10 | EPH0600169 | 10 | EPH1300362 | 13 | EPH1700121 | 13 | EPH2800262 | 14 |
| EPH0200169 | 10 | EPH0600171 | 10 | EPH1300369 | 13 | EPH1700123 | 13 | EPH2800269 | 14 |
| EPH0200171 | 10 | EPH0600321 | 10 | EPH1300371 | 13 | EPH1700161 | 13 | EPH2800271 | 14 |
| EPH0200321 | 10 | EPH0600323 | 10 | EPH1300521 | 11 | EPH1700162 | 13 | EPH2800321 | 14 |
| EPH0200323 | 10 | EPH0600361 | 10 | EPH1300523 | 11 | EPH1700169 | 13 | EPH2800323 | 14 |
| EPH0200361 | 10 | EPH0600362 | 10 | EPH1300561 | 11 | EPH1700171 | 13 | EPH2800361 | 14 |
| EPH0200362 | 10 | EPH0600369 | 10 | EPH1300562 | 11 | EPH1700321 | 13 | EPH2800362 | 14 |
| EPH0200369 | 10 | EPH0600371 | 10 | EPH1300569 | 11 | EPH1700323 | 13 | EPH2800369 | 14 |
| EPH0200371 | 10 | EPH0670121 | 10 | EPH1300571 | 11 | EPH1700361 | 13 | EPH2800371 | 14 |
| EPH0270121 | 10 | EPH0670123 | 10 | EPH1370121 | 13 | EPH1700362 | 13 | EPH2800421 | 14 |
| EPH0270123 | 10 | EPH0700121 | 12 | EPH1370123 | 13 | EPH1700369 | 13 | EPH2800423 | 14 |
| EPH0300121 | 10 | EPH0700123 | 12 | EPH1370521 | 11 | EPH1700371 | 13 | EPH2800621 | 14 |
| EPH0300123 | 10 | EPH0700161 | 12 | EPH1370523 | 11 | EPH1770121 | 13 | EPH2800623 | 14 |
| EPH0300161 | 10 | EPH0700162 | 12 | EPH1400121 | 11 | EPH1770123 | 13 | EPH2800661 | 14 |
| EPH0300162 | 10 | EPH0700169 | 12 | EPH1400123 | 11 | EPH1800121 | 13 | EPH2800662 | 14 |
| EPH0300169 | 10 | EPH0700171 | 12 | EPH1400161 | 11 | EPH1800123 | 13 | EPH2800669 | 14 |
| EPH0300171 | 10 | EPH0770121 | 12 | EPH1400162 | 11 | EPH1800161 | 13 | EPH2800671 | 14 |
| EPH0300321 | 10 | EPH0770123 | 12 | EPH1400169 | 11 | EPH1800162 | 13 | EPH2870121 | 14 |
| EPH0300323 | 10 | EPH0800121 | 12 | EPH1400171 | 11 | EPH1800169 | 13 | EPH2870123 | 14 |
| EPH0300361 | 10 | EPH0800123 | 12 | EPH1400321 | 11 | EPH1800171 | 13 | EPH2870442 | 14 |
| EPH0300362 | 10 | EPH0800161 | 12 | EPH1400323 | 11 | EPH1870121 | 13 | EPH2900121 | 15 |
| EPH0300369 | 10 | EPH0800162 | 12 | EPH1400361 | 11 | EPH1870123 | 13 | EPH2900123 | 15 |
| EPH0300371 | 10 | EPH0800169 | 12 | EPH1400362 | 11 | EPH1900121 | 13 | EPH2900161 | 15 |
| EPH0370121 | 10 | EPH0800171 | 12 | EPH1400369 | 11 | EPH1900123 | 13 | EPH2900162 | 15 |
| EPH0370123 | 10 | EPH0800321 | 12 | EPH1400371 | 11 | EPH1900161 | 13 | EPH2900169 | 15 |
| EPH0400121 | 10 | EPH0800323 | 12 | EPH1430321 | 11 | EPH1900162 | 13 | EPH2900171 | 15 |
| EPH0400123 | 10 | EPH0800361 | 12 | EPH1430323 | 11 | EPH1900169 | 13 | EPH2900221 | 15 |
| EPH0400161 | 10 | EPH0800362 | 12 | EPH1430361 | 11 | EPH1900171 | 13 | EPH2900223 | 15 |
| EPH0400162 | 10 | EPH0800369 | 12 | EPH1430362 | 11 | EPH1900321 | 13 | EPH2900261 | 15 |
| EPH0400169 | 10 | EPH0800371 | 12 | EPH1430369 | 11 | EPH1900323 | 13 | EPH2900262 | 15 |
| EPH0400171 | 10 | EPH0870121 | 12 | EPH1430371 | 11 | EPH1900361 | 13 | EPH2900269 | 15 |
| EPH0400321 | 10 | EPH0870123 | 12 | EPH1470121 | 11 | EPH1900362 | 13 | EPH2900271 | 15 |
| EPH0400323 | 10 | EPH0900121 | 12 | EPH1470123 | 11 | EPH1900369 | 13 | EPH2900521 | 15 |
| EPH0400361 | 10 | EPH0900123 | 12 | EPH1500121 | 11 | EPH1900371 | 13 | EPH2900523 | 15 |
| EPH0400362 | 10 | EPH0900161 | 12 | EPH1500123 | 11 | EPH2100121 | 10 | EPH2970121 | 15 |
| EPH0400369 | 10 | EPH0900162 | 12 | EPH1500161 | 11 | EPH2100123 | 10 | EPH2970123 | 15 |
| EPH0400371 | 10 | EPH0900169 | 12 | EPH1500162 | 11 | EPH2100161 | 10 | EPH2970221 | 15 |
| EPH0400421 | 10 | EPH0900171 | 12 | EPH1500169 | 11 | EPH2100162 | 10 | EPH2970223 | 15 |
| EPH0400423 | 10 | EPH0970121 | 12 | EPH1500171 | 11 | EPH2100169 | 10 | EPH2970542 | 15 |
| EPH0400461 | 10 | EPH0970123 | 12 | EPH1500321 | 11 | EPH2100171 | 10 | EPH3000121 | 14 |

Reference numbers

Overview

| Ref. | Pages | Ref. | Pages | Ref. | Pages | Ref. | Pages | Ref. | Pages |
|------------|-------|------------|-------|------------|-------|------------|-------|------------|-------|
| EPH3000123 | 14 | EPH3400161 | 16 | EPH3700271 | 16 | EPH5200121 | 17 | EPH5800662 | 19 |
| EPH3000161 | 14 | EPH3400162 | 16 | EPH3770121 | 16 | EPH5200123 | 17 | EPH5800669 | 19 |
| EPH3000162 | 14 | EPH3400169 | 16 | EPH3770123 | 16 | EPH5200161 | 17 | EPH5800671 | 19 |
| EPH3000169 | 14 | EPH3400171 | 16 | EPH4100121 | 17 | EPH5200162 | 17 | EPH5810221 | 19 |
| EPH3000171 | 14 | EPH3400221 | 16 | EPH4100123 | 17 | EPH5200169 | 17 | EPH5810223 | 19 |
| EPH3100121 | 15 | EPH3400223 | 16 | EPH4100161 | 17 | EPH5200171 | 17 | EPH5810261 | 19 |
| EPH3100123 | 15 | EPH3400261 | 16 | EPH4100162 | 17 | EPH5270121 | 17 | EPH5810262 | 19 |
| EPH3100161 | 15 | EPH3400262 | 16 | EPH4100169 | 17 | EPH5270123 | 17 | EPH5810269 | 19 |
| EPH3100162 | 15 | EPH3400269 | 16 | EPH4100171 | 17 | EPH5500121 | 15 | EPH5810271 | 19 |
| EPH3100169 | 15 | EPH3400271 | 16 | EPH4170121 | 17 | EPH5500123 | 15 | EPH5810321 | 19 |
| EPH3100171 | 15 | EPH3400321 | 16 | EPH4170123 | 17 | EPH5500161 | 15 | EPH5810323 | 19 |
| EPH3100321 | 15 | EPH3400323 | 16 | EPH4200121 | 17 | EPH5500162 | 15 | EPH5810361 | 19 |
| EPH3100323 | 15 | EPH3400361 | 16 | EPH4200123 | 17 | EPH5500169 | 15 | EPH5810362 | 19 |
| EPH3100361 | 15 | EPH3400362 | 16 | EPH4200161 | 17 | EPH5500171 | 15 | EPH5810369 | 19 |
| EPH3100362 | 15 | EPH3400369 | 16 | EPH4200162 | 17 | EPH5600121 | 19 | EPH5810371 | 19 |
| EPH3100369 | 15 | EPH3400371 | 16 | EPH4200169 | 17 | EPH5600123 | 19 | EPH6100121 | 19 |
| EPH3100371 | 15 | EPH3400421 | 16 | EPH4200171 | 17 | EPH5600161 | 19 | EPH6100123 | 19 |
| EPH3170121 | 15 | EPH3400423 | 16 | EPH4270121 | 17 | EPH5600162 | 19 | EPH6100161 | 19 |
| EPH3170123 | 15 | EPH3400461 | 16 | EPH4270123 | 17 | EPH5600169 | 19 | EPH6100162 | 19 |
| EPH3200121 | 16 | EPH3400462 | 16 | EPH4300121 | 17 | EPH5600171 | 19 | EPH6100169 | 19 |
| EPH3200123 | 16 | EPH3400469 | 16 | EPH4300123 | 17 | EPH5670121 | 19 | EPH6100171 | 19 |
| EPH3200161 | 16 | EPH3400471 | 16 | EPH4300161 | 17 | EPH5670123 | 19 | EPH6100221 | 19 |
| EPH3200162 | 16 | EPH3470121 | 16 | EPH4300162 | 17 | EPH5700121 | 17 | EPH6100223 | 19 |
| EPH3200169 | 16 | EPH3470123 | 16 | EPH4300169 | 17 | EPH5700123 | 17 | EPH6100261 | 19 |
| EPH3200171 | 16 | EPH3470321 | 16 | EPH4300171 | 17 | EPH5700161 | 17 | EPH6100262 | 19 |
| EPH3200221 | 16 | EPH3470323 | 16 | EPH4370121 | 17 | EPH5700162 | 17 | EPH6100269 | 19 |
| EPH3200223 | 16 | EPH3500121 | 16 | EPH4370123 | 17 | EPH5700169 | 17 | EPH6100271 | 19 |
| EPH3200261 | 16 | EPH3500123 | 16 | EPH4400121 | 17 | EPH5700171 | 17 | EPH6200121 | 11 |
| EPH3200262 | 16 | EPH3500161 | 16 | EPH4400123 | 17 | EPH5770121 | 17 | EPH6200123 | 11 |
| EPH3200269 | 16 | EPH3500162 | 16 | EPH4400161 | 17 | EPH5770123 | 17 | EPH6200161 | 11 |
| EPH3200271 | 16 | EPH3500169 | 16 | EPH4400162 | 17 | EPH5800121 | 19 | EPH6200162 | 11 |
| EPH3200321 | 16 | EPH3500171 | 16 | EPH4400169 | 17 | EPH5800123 | 19 | EPH6200169 | 11 |
| EPH3200323 | 16 | EPH3500221 | 16 | EPH4400171 | 17 | EPH5800161 | 19 | EPH6200171 | 11 |
| EPH3200361 | 16 | EPH3500223 | 16 | EPH4470121 | 17 | EPH5800162 | 19 | EPH6270121 | 11 |
| EPH3200362 | 16 | EPH3500261 | 16 | EPH4470123 | 17 | EPH5800169 | 19 | EPH6270123 | 11 |
| EPH3200369 | 16 | EPH3500262 | 16 | EPH4700121 | 17 | EPH5800171 | 19 | EPH6400121 | 18 |
| EPH3200371 | 16 | EPH3500269 | 16 | EPH4700123 | 17 | EPH5800221 | 19 | EPH6400123 | 18 |
| EPH3270121 | 16 | EPH3500271 | 16 | EPH4700161 | 17 | EPH5800223 | 19 | EPH6400161 | 18 |
| EPH3270123 | 16 | EPH3500321 | 16 | EPH4700162 | 17 | EPH5800261 | 19 | EPH6400162 | 18 |
| EPH3270321 | 16 | EPH3500323 | 16 | EPH4700169 | 17 | EPH5800262 | 19 | EPH6400169 | 18 |
| EPH3270323 | 16 | EPH3500361 | 16 | EPH4700171 | 17 | EPH5800269 | 19 | EPH6400171 | 18 |
| EPH3300121 | 16 | EPH3500362 | 16 | EPH4770121 | 17 | EPH5800271 | 19 | EPH6470121 | 18 |
| EPH3300123 | 16 | EPH3500369 | 16 | EPH4770123 | 17 | EPH5800321 | 19 | EPH6470123 | 18 |
| EPH3300161 | 16 | EPH3500371 | 16 | EPH4800121 | 17 | EPH5800323 | 19 | EPH6500121 | 18 |
| EPH3300162 | 16 | EPH3600121 | 16 | EPH4800123 | 17 | EPH5800361 | 19 | EPH6500123 | 18 |
| EPH3300169 | 16 | EPH3600123 | 16 | EPH4800161 | 17 | EPH5800362 | 19 | EPH6500161 | 18 |
| EPH3300171 | 16 | EPH3600161 | 16 | EPH4800162 | 17 | EPH5800369 | 19 | EPH6500162 | 18 |
| EPH3300221 | 16 | EPH3600162 | 16 | EPH4800169 | 17 | EPH5800371 | 19 | EPH6500169 | 18 |
| EPH3300223 | 16 | EPH3600169 | 16 | EPH4800171 | 17 | EPH5800421 | 19 | EPH6500171 | 18 |
| EPH3300261 | 16 | EPH3600171 | 16 | EPH4870121 | 17 | EPH5800423 | 19 | EPH6570121 | 18 |
| EPH3300262 | 16 | EPH3670121 | 16 | EPH4870123 | 17 | EPH5800461 | 19 | EPH6570123 | 18 |
| EPH3300269 | 16 | EPH3670123 | 16 | EPH4900121 | 17 | EPH5800462 | 19 | EPH6600121 | 18 |
| EPH3300271 | 16 | EPH3700121 | 16 | EPH4900123 | 17 | EPH5800469 | 19 | EPH6600123 | 18 |
| EPH3300321 | 16 | EPH3700123 | 16 | EPH4900161 | 17 | EPH5800471 | 19 | EPH6600161 | 18 |
| EPH3300323 | 16 | EPH3700161 | 16 | EPH4900162 | 17 | EPH5800521 | 19 | EPH6600162 | 18 |
| EPH3300361 | 16 | EPH3700162 | 16 | EPH4900169 | 17 | EPH5800523 | 19 | EPH6600169 | 18 |
| EPH3300362 | 16 | EPH3700169 | 16 | EPH4900171 | 17 | EPH5800561 | 19 | EPH6600171 | 18 |
| EPH3300369 | 16 | EPH3700171 | 16 | EPH5000121 | 17 | EPH5800562 | 19 | EPH6670121 | 18 |
| EPH3300371 | 16 | EPH3700221 | 16 | EPH5000123 | 17 | EPH5800569 | 19 | EPH6670123 | 18 |
| EPH3300721 | 16 | EPH3700223 | 16 | EPH5000161 | 17 | EPH5800571 | 19 | EPH9700121 | 14 |
| EPH3300723 | 16 | EPH3700261 | 16 | EPH5000162 | 17 | EPH5800621 | 19 | EPH9700123 | 14 |
| EPH3400121 | 16 | EPH3700262 | 16 | EPH5000169 | 17 | EPH5800623 | 19 | EPH9700161 | 14 |
| EPH3400123 | 16 | EPH3700269 | 16 | EPH5000171 | 17 | EPH5800661 | 19 | EPH9700162 | 14 |

Reference numbers

Overview

| Ref. | Pages |
|------------|-------|
| EPH9700169 | 14 |
| EPH9700171 | 14 |
| EPH9700221 | 14 |
| EPH9700223 | 14 |
| EPH9700261 | 14 |
| EPH9700262 | 14 |
| EPH9700269 | 14 |
| EPH9700271 | 14 |
| EPH9800121 | 14 |
| EPH9800123 | 14 |
| EPH9800161 | 14 |
| EPH9800162 | 14 |
| EPH9800169 | 14 |
| EPH9800171 | 14 |
| EPH9800221 | 14 |
| EPH9800223 | 14 |
| EPH9800261 | 14 |
| EPH9800262 | 14 |
| EPH9800269 | 14 |
| EPH9800271 | 14 |
| EPH9810221 | 14 |
| EPH9810223 | 14 |
| EPH9810261 | 14 |
| EPH9810262 | 14 |
| EPH9810269 | 14 |
| EPH9810271 | 14 |
| EPH9900121 | 15 |
| EPH9900123 | 15 |
| EPH9900161 | 15 |
| EPH9900162 | 15 |
| EPH9900169 | 15 |
| EPH9900171 | 15 |



Green Premium™

An industry leading portfolio of offers delivering sustainable value



More than 75% of our product sales offer superior transparency on the material content, regulatory information and environmental impact of our products:

- RoHS compliance
- REACh substance information
- Industry leading # of PEP's*
- Circularity instructions



Discover what we mean by green

[Check your products!](#)

The Green Premium program stands for our commitment to deliver customer valued sustainable performance. It has been upgraded with recognized environmental claims and extended to cover all offers including Products, Services and Solutions.

CO₂ and P&L impact through... Resource Performance

Green Premium brings improved resource efficiency throughout an asset's lifecycle. This includes efficient use of energy and natural resources, along with the minimization of CO₂ emissions.

Cost of ownership optimization through... Circular Performance

We're helping our customers optimize the total cost of ownership of their assets. To do this, we provide IoT-enabled solutions, as well as upgrade, repair, retrofit, and remanufacture services.

Peace of mind through... Well-being Performance

Green Premium products are RoHS and REACh compliant. We're going beyond regulatory compliance with step-by-step substitution of certain materials and substances from our products.

Improved sales through... Differentiation

Green Premium delivers strong value propositions through third-party labels and services. By collaborating with third-party organizations we can support our customers in meeting their sustainability goals such as green building certifications.

*PEP: Product Environmental Profile (i.e. Environmental Product Declaration)

Life Is On | **Schneider**
Electric

Schneider Electric Industries SAS

35, rue Joseph Monier
CS 30323
92506 Rueil Malmaison Cedex
France

RCS Nanterre 954 503 439
Capital social 928 298 512 €
www.se.com

07-2020

© 2020 - Schneider Electric. All Rights Reserved.
All trademarks are owned by Schneider Electric Industries SAS or its affiliated companies.
Document reference: LSB02658EN

This document has been
printed on recycled paper

