

FLIR True RMS 400A Clamp Meter Series

Models CM42, CM44, and CM46

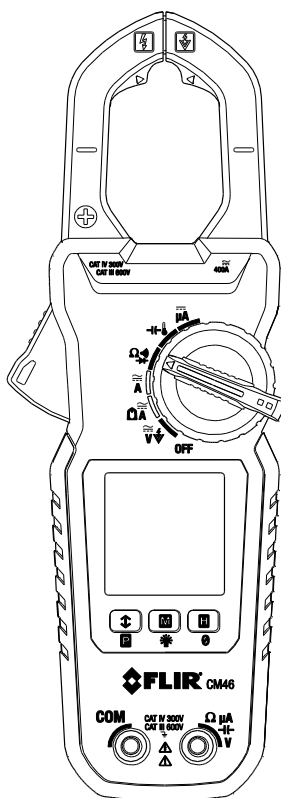
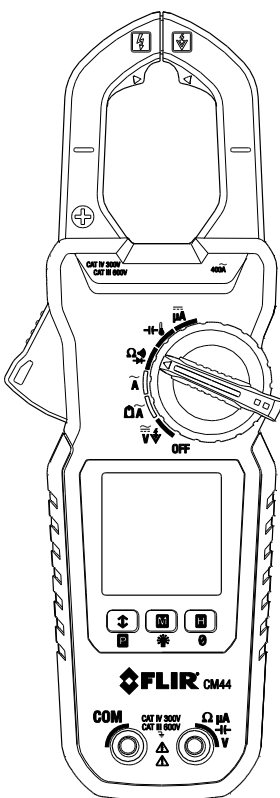
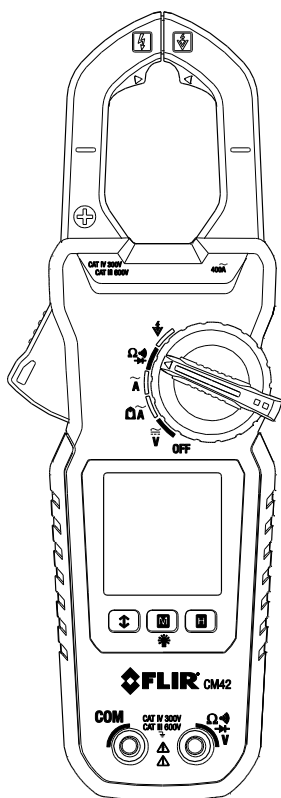

Table of Contents

1. DISCLAIMERS	4
1.1 Copyright	4
1.2 Quality Assurance	4
1.3 Documentation	4
1.4 Disposal of Electronic Waste	4
2. SAFETY	5
3. INTRODUCTION	7
4. DESCRIPTION	8
4.1 Meter Parts	8
4.2 Function Switch Positions	9
4.3 Function Buttons	10
4.4 Display Icons and Indicators	10
5. OPERATION	12
5.1 Powering the Meter	12
5.2 Intelligent Auto Power OFF (APO) feature	12
5.3 Auto Range	12
5.4 Out-of-range Warning	12
5.5 Voltage Measurements	13
5.6 Electric Field (EF) Detection	14
5.7 Standard Current Clamp Measurements	15
5.8 Low Current Accu-Tip™ Clamp Measurements	17
5.9 DC μ A Current Test Lead Measurements (CM44 and CM46)	18
5.10 Resistance Measurements	19
5.11 Continuity Tests	19
5.12 Capacitance Measurements (CM44 and CM46)	20
5.13 Temperature Measurements (CM44 and CM46)	21
5.14 Diode Tests	22
5.15 Relative / DC Zero Modes (CM44 and CM46)	23
5.16 MIN/MAX/AVG Recording	23

5.17 VFD Mode (low pass filter)	23
5.18 Display Hold Function	24
5.19 Display Backlighting	24
5.20 PEAK Mode (CM44 and CM46)	24
6. MAINTENANCE	25
6.1 Troubleshooting Tips	25
6.2 Accuracy and Calibration	25
6.3 Cleaning and Storage	25
6.4 Battery Replacement	25
7. SPECIFICATIONS	26
7.1 General specifications	26
7.2 Electrical specifications	28
8. TECHNICAL SUPPORT	31
9. WARRANTY	32

1. Disclaimers

1.1 Copyright

© 2016, FLIR Systems, Inc., All rights reserved worldwide. No parts of the software including source code may be reproduced, transmitted, transcribed or translated into any language or computer language in any form or by any means, electronic, magnetic, optical, manual or otherwise, without the prior written permission of FLIR Systems.

The documentation must not, in whole or part, be copied, photocopied, reproduced, translated or transmitted to any electronic medium or machine readable form without prior consent, in writing, from FLIR Systems.

Names and marks appearing on the products herein are either registered trademarks or trademarks of FLIR Systems and/or its subsidiaries. All other trademarks, trade names or company names referenced herein are used for identification only and are the property of their respective owners.

1.2 Quality Assurance

The Quality Management System under which these products are developed and manufactured has been certified in accordance with the ISO 9001 standard.

FLIR Systems is committed to a policy of continuous development; therefore, we reserve the right to make changes and improvements on any of the products without prior notice.

1.3 Documentation

To access the latest manuals and notifications, go to the Download tab at: <http://support.flir.com>. It only takes a few minutes to register online. In the download area you will also find the latest releases of manuals for our other products, as well as manuals for our historical and obsolete products.

1.4 Disposal of Electronic Waste



As with most electronic products, this equipment must be disposed of in an environmentally friendly way, and in accordance with existing regulations for electronic waste.

Please contact your FLIR Systems representative for more details.

2. Safety

SAFETY NOTES

This user manual contains information and warnings that must be followed for operating the instrument safely and maintaining the instrument in a safe operating condition. If the instrument is used in a manner not specified by the manufacturer, the protection provided by the instrument may be impaired.

The meter protection rating, against the users, is double insulation per UL/IEC/EN61010-1 Ed. 3.0, IEC/EN61010-2-033 Ed. 1.0, CAN/CSA C22.2 No. 61010-1 Ed. 3.0, IEC/EN61010-2-032 Ed. 3.0 & IEC/EN61010-031 Ed. 1.1: Measurement Category III 600V & Category IV 300V AC & DC.

BRIEF INFORMATION ABOUT MEASUREMENT CATEGORIES

Measurement Category IV is applicable to test and measuring circuits connected at the source of the building's low-voltage MAINS installation. Examples are measurements on devices installed before the main fuse or circuit breaker in the building installation.

Measurement Category III is applicable to test and measuring circuits connected to the distribution part of the building's low-voltage MAINS installation. Examples are measurements on distribution boards (including secondary meters), circuit-breakers, wiring, including cables, bus-bars, junction boxes, switches, socket-outlets in the fixed installation, and equipment for industrial use and some other equipment such as stationary motors with permanent connection to the fixed installation.

Measurement Category II is applicable to test and measuring circuits connected directly to utilization points (socket outlets and similar points) of the low-voltage MAINS installation. Examples are measurements on MAINS CIRCUITS of household appliances, portable tools and similar equipment.

TERMS USED IN THIS MANUAL

WARNING  Identifies conditions and actions that could result in serious injury or even death to the user.

CAUTION  Identifies conditions and actions that could cause damage or malfunction in the instrument.



WARNING STATEMENTS

To reduce the risk of fire or electric shock, do not expose this product to rain or moisture. The meter is intended only for indoor use.

To avoid electrical shock hazard, observe the proper safety precautions when working with voltages above 60 VDC or 30 VAC rms. These voltage levels pose a potential shock hazard to the user. Before and after hazardous voltage measurements, test the voltage function on a known source such as line voltage to determine proper meter functioning.

Keep hands/fingers behind the hand/finger barriers (of the meter and the test leads) during measurement. Inspect test leads, connectors, and probes for damaged insulation or exposed metal

before using the instrument. If any defects are found, replace them immediately. Use only the test leads provided with the equipment (or UL Listed Probe Assemblies rated CAT III 600V or better).

The accompanied test probe assembly meets UL/IEC/EN61010-031 Ed. 1.1 to the same meter ratings or better. IEC 61010-031 requires exposed conductive test probe tips to be $\leq 4\text{mm}$ for CAT III & CAT IV ratings. Refer to the category markings on your probe assemblies as well as on the add-on accessories (detachable Caps or Alligator Clips, etc.), if any, for applicable rating changes.

This Clamp meter is designed to be clamped around or removed from un-insulated, hazardous live conductors. Nonetheless, individual protective equipment must be used when hazardous live parts in the installation, where the measurement is to be carried out, could be accessible.

Remove test leads from meter before taking clamp measurements.



CAUTION STATEMENTS

Disconnect the test leads from the test points before changing meter functions.

Disconnect the test leads from the meter before taking clamp measurements.

Do not use the device for a procedure that it is not intended for. This can cause damage to the protection built into the instrument.



UL listing is not an indication or a verification of the accuracy of the meter

INTERNATIONAL ELECTRICAL SYMBOLS



Caution! Refer to the explanation in this Manual



Caution! Risk of electric shock



Earth (Ground)



Double Insulation or Reinforced insulation



Fuse



AC (Alternating Current)



DC (Direct Current)



Application around, and removal from, hazardous live conductors is permitted

CENELEC DIRECTIVES

The instruments conform to CENELEC Low-voltage directive 2014/35/EC, Electromagnetic compatibility directive 2014/30/EU and RoHS directive 2011/65/EU.

3. Introduction

Thank you for selecting the FLIR Auto Range, True RMS 400A Clamp Meter with Low Pass Filter and Accu-Tip™ low current measurement technology.

All meters in this series measure 400A AC, 600V AC/DC, Resistance, Continuity, Frequency, and Diode. Features include Non-Contact Voltage Detector, Data Hold, MIN/MAX/AVG, and display backlighting.

The CM44 and CM46 also offer Capacitance, Peak, μ A DC (test leads), Relative/DC Zero, and Thermocouple features.

The CM46 also provides DC, DC+ACV, and DC+DCA clamp measurements.

This device is shipped fully tested and calibrated and, with proper use, will provide years of reliable service.

Key Features:

All Models

- 6000-count digital backlit display
- 600V AC/DC test lead measurements
- Auto Range True RMS AC 400A AC clamp measurements
- Low current Accu-Tip™ clamp measurements
- AC bandwidth frequency 50~400Hz (50~60Hz for ACV and AC+DCV)
- Frequency measurements 50~400Hz for ACA and 50~999.9Hz for ACV
- Resistance measurements to 60k ohms
- Continuity and Diode measurements
- Non-contact (NCV) Voltage Detection (EF)
- Display Hold
- Minimum/Maximum/Average recording memory
- Integrated VFD mode (Low-pass filter) on ACV and Hz measurements
- Intelligent Auto power OFF (APO)
- Jaw opening: 30mm (1.2")
- Safety Category Rating: CAT III 600V & CAT IV 300V AC & DC

CM44 and CM46 Features

- Capacitance measurements
- DC μ A test lead current measurements
- Peak-rms inrush current detect to 80ms
- Thermocouple temperature measurements
- Relative/DC Zero functions

CM46-only Features

- AC+DC measurements
- 40/400A DC Clamp measurements

4. Description

4.1 Meter Parts

1. Non-contact voltage detector
2. Function select switch
3. LCD Display
4. Control buttons
5. Positive (+) Probe Input jack
6. COM (negative -) Probe Input jack
7. Clamp jaw trigger
8. Clamp jaws
9. Low current Accu-Tip™ clamp area

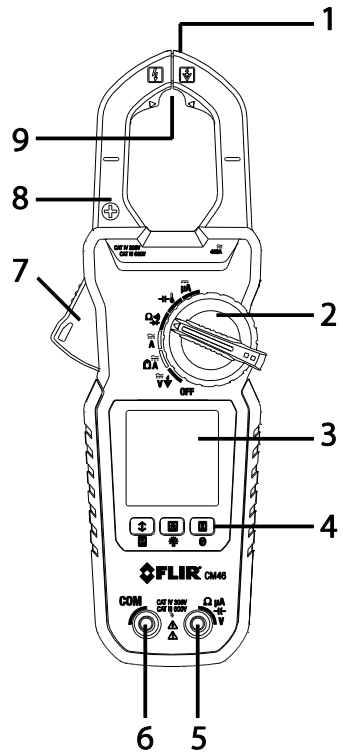



















Figure 4-1 Meter Description

Note: Battery compartment and Warning text label on back of meter.

4.2 Function Switch Positions

OFF	Switch the meter OFF (full power saving mode)
	Measure AC/DC Voltage through the probe inputs
	Measure electric field (EF) using the non-contact voltage detector
	Measure AC or DC current through the clamp jaws (CM46)
	Measure AC current in the large clamp jaw area (CM42 and CM44)
	Measure low AC current through the small clamp jaw area (Accu-Tip™). CM42 and CM44
	Measure low AC or DC current through the small clamp jaw area (Accu-Tip™). CM46
	Measure resistance, continuity, and diode through the probe inputs. The type of measurement is chosen by the mode  button.
	Measure capacitance and temperature through the probe inputs. The type of measurement is chosen by the  button. CM44 and CM46
	Measure DC microamperes (current) through the probe inputs. CM44 and CM46

4.3 Function Buttons

	Short presses to access and step through MIN-MAX-AVG recorded readings. Long press to exit the mode.
	Long press to access 80ms PEAK RMS mode. CM44 and CM46.
	Short presses to step through available modes for selected function
	Long press to switch the display backlight ON or OFF. Backlight switches off automatically after 32 seconds (approx.).
	Short presses to access/exit the display hold mode
	Relative Zero CM44 Relative & DC Zero CM46

4.4 Display Icons and Indicators

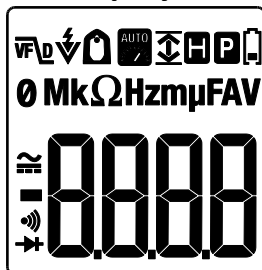























Figure 4-2 Display Icon Descriptions

Refer to Fig. 4-2 above for the display icon descriptions below:

	Meter is displaying maximum (up arrow), minimum (down arrow) or average reading (up and down arrows)
	80ms PEAK current/voltage rms mode
	Low current Accu-Tip™ mode
	Auto range mode
	Display Hold mode

	Low battery voltage warning
	AC current or voltage measurement
	DC current or voltage measurement
	Continuity function
	Diode test
	Ohm symbol. Unit of measure for Resistance and Continuity.
	Unit of measure for current (Amps or Amperes).
	EF voltage detector mode
	Volt. Unit of measure for Voltage
	Farad. Unit of measure for Capacitance
	Hertz. Unit of measure for Frequency
	10^3 (kilo)
	10^{-3} (milli)
	10^{-6} (micro)
	VFD mode (low pass filter) icon
	Relative Zero CM44 Relative & DC Zero CM46

5. Operation

Notes:

Before operating the device, you must read, understand, and follow all instructions, dangers, warnings, cautions, and notes.

When the meter is not in use, the function switch should be set to the OFF position.

When connecting the probe leads to the device under test, connect the negative lead before connecting the positive lead. When removing the probe leads, remove the positive lead before removing the negative lead.

Before and after hazardous voltage measurements, test the voltage function on a known source (such as line voltage) to determine proper meter functionality.

5.1 Powering the Meter

1. Set the function switch to any position to switch the meter ON.
2. If the low battery voltage warning  is displayed or if the meter does not power on, replace the batteries. See [Section 6.4 Battery Replacement](#).

5.2 Intelligent Auto Power OFF (APO) feature

The Auto-Power-off (APO) features switches the meter off automatically after approximately 32 minutes of inactivity to conserve battery energy. The meter will not switch off if any of the following conditions are met:

- Rotary switch or push button operation
- If the measured reading is > 8.5% of the full scale range (for example, in the 60A range, 8.5% of 60A = 5.1A; therefore, if the measurement is > 5.1A the APO function will be disabled and if the measurement is < 5.1A the APO function will operate normally).
- Non-OL readings for Resistance, Continuity or Diode function
- Non-zero readings for Hz function

To wake the meter from APO, short press the mode  button, or turn the rotary switch OFF and then back on. Always turn the rotary switch to the OFF position when the meter is not in use.

5.3 Auto Range

The meter automatically selects the most appropriate measurement scale. The  indicator is displayed to inform the user that Auto Range is functioning.

5.4 Out-of-range Warning

If the input is out-of-range, OL is displayed.

5.5 Voltage Measurements

CAUTION! Use caution when the measured voltage is greater than 30 V DC or AC RMS

1. Set the function switch to the \tilde{V} position*.
2. Insert the black probe lead into the negative COM terminal and the red probe lead into the positive V terminal.
3. Connect the probe leads in parallel to the part under test.
4. Use the M (mode) button to step through the available sub-functions: ACV, DCV, ACV+DCV (CM46 only), Line Frequency (Hz), Electric Field (EF) detection (*CM42 has a dedicated switch position for EF); see [Section 5.6 Electric Field \(EF\) Detection](#).
5. Read the measurement value on the display.
6. The VFD (low pass filter) feature is always active for ACV measurements. This low pass filter accommodates measurements on variable frequency drives and measurements in electrically noisy environments.
7. For EF voltage detector testing, see [Section 5.6 Electric Field \(EF\) Detection](#).

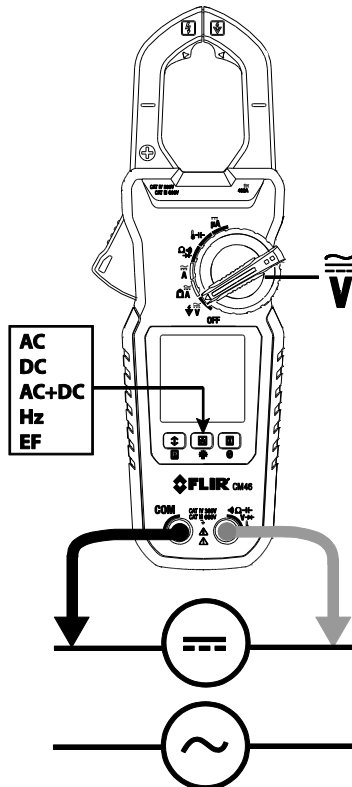

Figure 5-1 Voltage Measurements

5.6 Electric Field (EF) Detection

For non-contact EF detection (Fig. 5-2) a sensor is situated at the top right of the meter's clamp jaws. The sensor detects the electric field emanating from energized conductors. This feature can be used to trace live wiring, locating breaks in circuits, and to determine live or earth connections. Refer to Figures 5-2.

1. Set the function switch to the $\overline{\sim}$ position (for CM44 and CM46) or the dedicated EF position (CM42).
2. If necessary, use the M (mode) button to step to the EF function
3. For non-contact EF detection ensure that the test leads are disconnected from the meter. Place the tip of the meter jaws close to the source of electrical energy. If voltage is detected, the meter will beep and display dashes. The rate of beeping and the number of dashes (from 1 to 5) displayed are in proportion to the strength of the detected field.

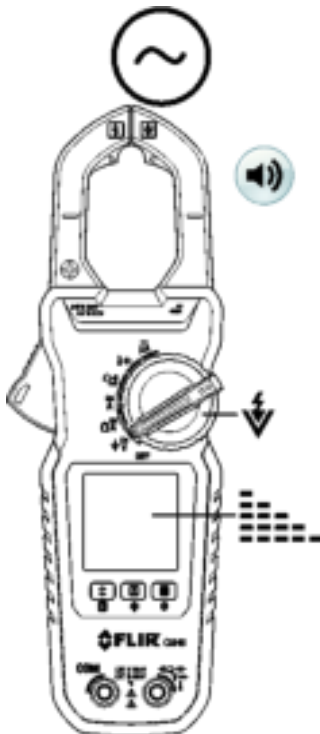

Figure 5-2 Non-Contact Voltage Detect

5.7 Standard Current Clamp Measurements



WARNING!

- Do not measure the current on a circuit when the voltage increases to more than 600V. This can cause damage to the instrument and can cause injury to persons.
- Do not use the meter to measure currents above the rated frequency (400Hz). Circulating currents may cause the magnetic circuits of the Jaws to reach hazardous temperatures.
- Disconnect the test leads from the meter before taking Clamp measurements.
- Measurement Preparation
- For clamp-on current measurements, press the jaw trigger and clamp the jaws around the conductor(s) of only one pole of a circuit.
- Ensure that the jaws are completely closed. Enclosing conductor(s) of more than one pole of a circuit may result in differential current measurements.
- Align the conductor(s) to the Jaws center indicators as close as possible.
- Adjacent current-carrying devices such as transformers, motors and conductor wires may affect measurement accuracy.

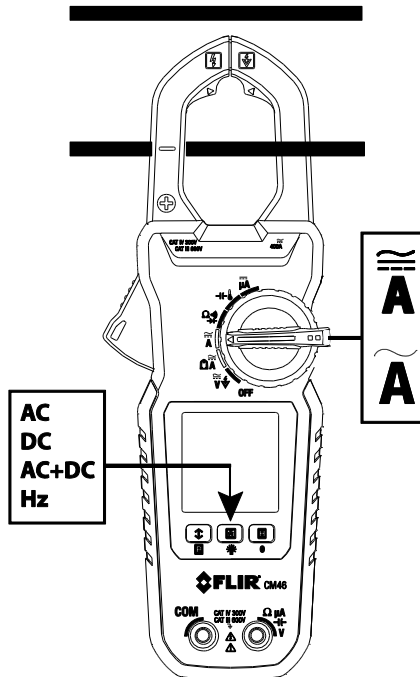





Figure 5-3 Correct and incorrect clamping

1. Ensure that the probe leads are disconnected from the meter.
2. Set the function switch to the  (AC),  (AC, DC, or AC+DC). DC and AC+DC measurements are available on the CM46 only. For low current measurements please refer to Section 5.8.
3. Use the M (mode) button to select AC, DC (CM46), AC+DC (CM46), or frequency (Hz).
4. For DC Current measurements (CM46), with no conductors in the clamp, press the Zero button  to enable DC Zero. The display will show “dc_0” and the display will zero.
5. Press the trigger to open the clamp jaws and fully enclose one pole of a circuit—refer to Fig. 5-3. For optimum results, center the conductor in the jaws.
6. Read the current value on the display.

5.8 Low Current Accu-Tip™ Clamp Measurements

WARNING!

- Do not measure the current on a circuit when the voltage increases to more than 600V. This can cause damage to the instrument and can cause injury to persons.
- Do not use the meter to measure currents above the rated frequency (400Hz). Circulating currents may cause the magnetic circuits of the Jaws to reach hazardous temperatures.
- Disconnect the test leads from the meter before taking Clamp measurements.

Measurement Preparation

1. For clamp-on current measurements, press the jaw trigger and clamp the jaws around the conductor(s) of only one pole of a circuit. See Fig. 5-5.
2. Ensure that the jaws are completely closed. Enclosing conductor(s) of more than one pole of a circuit may result in differential current measurements.
3. Align the conductor(s) to the top of the Jaws center, in the dedicated low current Accu-Tip™ area, as shown, for the best accuracy. The maximum allowable conductor size is 8.8mm (0.35").
4. Adjacent current-carrying devices such as transformers, motors and conductor wires may affect measurement accuracy.
5. Ensure that the probe leads are disconnected from the meter.

Measurements

1. Set function switch to the  position (\tilde{A} or \tilde{A} depending on model).
2. Use the M (mode) button to select AC (All models), DC (CM46), or AC+DC (CM46)
3. Press the trigger to open the clamp jaws. Fully enclose the conductor(s) of a single pole—refer to Figure 5.4
4. Read the current value on the display.

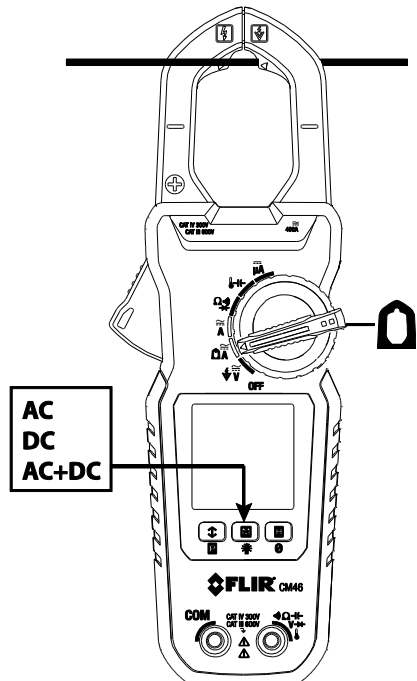

Figure 5-4 Low Current Clamp Measurements

5.9 DC μA Current Test Lead Measurements (CM44 and CM46)

1. Set the function switch to the μA position.
2. Insert the black probe lead into the negative COM terminal and the red probe lead into the positive terminal.
3. Touch the tips of the probe in series with the circuit under test as shown in Fig. 5-5.
4. Read the current value on the display.

The DC μA function is designed especially for HVAC flame sensor applications. The 0.1 μA resolution is useful for identifying the very small current changes in flame detector applications. Flame signal current check should indicate steady flame signal of at least 2 μA for a rectification type, or 1.5 μA for an ultraviolet type (8 μA for self-checking systems). For flame signal currents with inadequate strength or with fluctuations beyond 10%, check the following to avoid the risk of unwanted flame relay dropout:

For gas or oil flames (UV):

- Low supply voltage
- Detector location
- Defective detector wiring
- Dirty viewing windows

For oil flames (Photocell):

- Detector location & wiring
- Smoky flame or poorly adjusted air shutter
- Faulty Photocell
- Temperature > 165 °F (74 °C) at photocell

For gas flames (Flame Rod):

- Ignition interference (A flame signal current difference with the ignition both on and off greater than 0.5 μA indicates the presence of ignition interference)
- Insufficient ground (must be at least 4 times the detector area)
- Flame lifting off burner head (ground), or not continuously in contact with the flame rod
- Temperature > 600 °F (316 °C) at the flame electrode insulator causing short to ground.

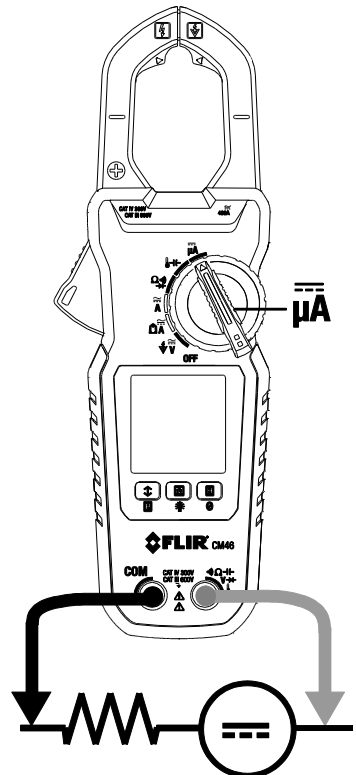

Figure 5-5 μADC Measurements

5.10 Resistance Measurements



WARNING! Do not perform resistance tests before removing the power from resistors and other devices under test during a measurement. Injury to persons can occur.

1. Set the function switch to the Ω position.
2. Use the M (mode) button to select resistance mode.
3. Insert the black probe lead into the negative COM terminal and the red probe lead into the positive Ω terminal.
4. Touch the tips of the probe across the circuit or component under test (see Fig. 5-6).
5. Read the resistance value on the display.

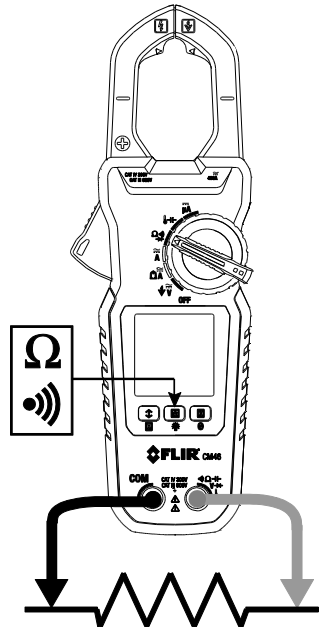

Figure 5-6 Resistance/Continuity Measurements

5.11 Continuity Tests



WARNING! Do not perform continuity tests before removing the power to the component, circuit, or other device under test during a measurement. Injury to persons can occur.

1. Set the function switch to the ⦿ position.
2. Insert the black probe lead into the negative COM terminal and the red probe lead into the positive Ω terminal. Refer to Fig. 5-6 for connection example.
3. Use the M (mode) button to select continuity measurement. The ⦿ indicator will be displayed.
4. Touch the tips of the probe across the circuit or component under test (see Fig. 5-6).
5. If the resistance measurement $< 10 \Omega$, the meter will beep. If the resistance measurement is $> 250 \Omega$, the meter will not beep. Between 10Ω and 250Ω , the meter will stop beeping at an unspecified point.

5.12 Capacitance Measurements (CM44 and CM46)



WARNING! Do not perform capacitance tests before removing the power to the capacitor or to other devices under test during a measurement. Injury to persons can occur.

1. Set the function switch to the C position.
2. Use the M (mode) button to select capacitance function (capacitor symbol must be displayed).
3. Insert the black probe lead into the negative COM terminal and the red probe lead into the positive C terminal.
4. Touch the tips of the probe across the part under test (see Fig. 5-7).
5. Read the capacitance value on the display.

Note: For very large capacitance values, several seconds may be required for the measurement to settle and for the final reading to stabilize.

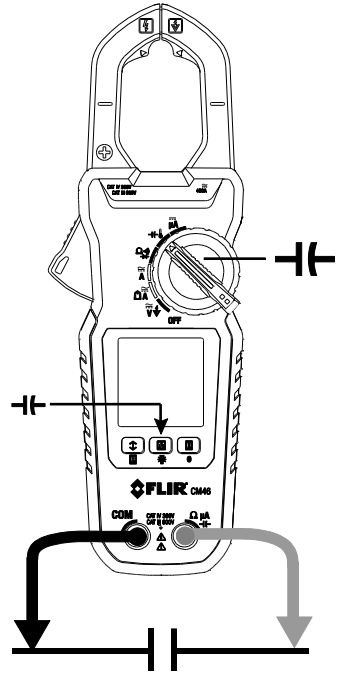



Figure 5-7 Capacitance Measurements

5.13 Temperature Measurements (CM44 and CM46)

Insert the banana plug Type-K temperature bead probe into the meter's input terminals observing correct polarity.

A plug adapter with banana plug to Type-K socket (to adapt to other Type-K standard mini plug temperature probes) can be obtained optionally.

Supplied thermocouple is rated for -20~250 °C (-4~482°F) only and therefore not rated for the entire specified temperature range of the meter.

1. Set the function switch to the  position.
2. Use the M (mode) button to select degrees F or degrees C for temperature units.
3. Insert the temperature probe banana plugs into the negative COM terminal and positive terminal observing correct polarity.
4. Touch the tip of the temperature probe to the surface under test or simply hold the temperature probe in air to measure the air temperature (see Fig. 5-8).
5. Read the temperature value on the display.

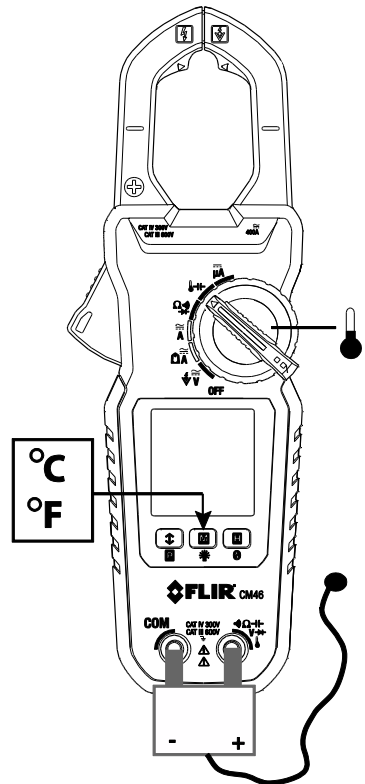



Figure 5-8 Temperature Measurements

5.14 Diode Tests



WARNING! Do not perform diode tests before removing the power to the diode or other devices under test during a measurement. Injury to persons can occur.

1. Set the function switch to the diode  position.
2. Insert the black probe lead into the negative COM terminal and the red probe lead into the positive Ω terminal.
3. Use the M (mode) button to select the diode test function. The diode indicator  will be displayed.
4. Touch the tips of the probe across the diode or semiconductor junction under test (see Fig. 5-9).
5. If the reading is between 0.40 and 0.90V in one direction and OL (overload) in the opposite direction, the component is good. If the measurement is 0V in both directions (shorted) or OL in both directions (open), the component is bad.

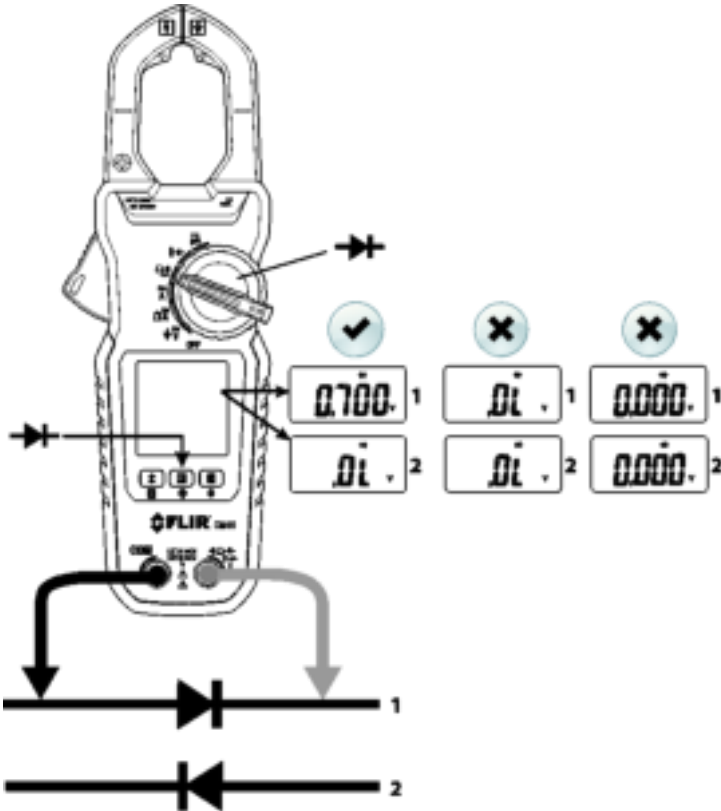



Figure 5-9 Diode Tests





5.15 Relative / DC Zero Modes (CM44 and CM46)

DC Zero is available for DCA & DC+ACA functions. All other functions make use of the Relative function.

DC ZERO



To zero (offset) a non-zero DCA residual signal caused by magnetic hysteresis of the jaws (for DCA and DCA+ACA functions), long press the  button to activate/re-activate. For best accuracy, apply this technique before making any single DCA or DCA+ACA measurement. The meter displays “dc_0” briefly to confirm activation. The beeper will emit 3 short beeps if the residual is beyond a reasonable hysteresis reading of ± 5 DCA.





RELATIVE MODE

To access the Relative function, long press the  button and the display icon  will appear. The measurement value displayed when the button is pressed will be stored by the meter as a reference value. Subsequent measurements made, while the Relative mode is active, will be compared to the stored reference and the meter will display the difference between the stored reference and the actual measurement. Long press the  button to exit this mode and the display icon  will switch off.

5.16 MIN/MAX/AVG Recording

In MIN/MAX/AVG record mode, the meter captures and displays the Minimum, Maximum, and Average readings and updates only when a change in measurement value is registered.

Short press the  button to access the recording mode. The MAX, MIN, and AVG icon  will appear indicating that the meter is now recording MAX, MIN, and AVG readings (but displaying real time readings).

Short press the  button to step through the recorded MAX , MIN , and AVG  values.

Long press the  button to exit this mode. The icons will switch off. The meter will return to normal operation and the MAX, MIN, and AVG memories will be reset. The Auto Power OFF feature is disabled when the meter is in the MIN-MAX-AVG recording mode.

5.17 VFD Mode (low pass filter)

The VFD feature eliminates high frequency noise in voltage measurements by means of a low-pass filter. The VFD mode is designed for variable frequency drive (VFD) measurements. This mode is always active for ACV and Hz measurements and the VFD display icon is displayed .

5.18 Display Hold Function

In Display Hold mode, the reading is held on the display.



Short press the **H** (hold) button to toggle the Display Hold function ON and OFF.

In Hold mode, the  indicator is displayed.

5.19 Display Backlighting

A long press of the  button activates/deactivates the backlighting. The backlight switches off automatically after approximately 32 seconds to conserve battery energy.

5.20 PEAK Mode (CM44 and CM46)

A long press of the  button arms the Peak mode feature. The LCD icon  is displayed when Peak mode is active. Measurements made with Peak mode activated capture inrush current or voltage RMS values. The Peak measurement window is 80ms in duration. Auto-Power-Off is disabled automatically in this mode. A long press of the  button switches this feature off.

6. Maintenance



WARNING!

To avoid electrical shock, disconnect the meter from any circuit, remove the test leads from the input jacks and turn OFF the meter before opening the meter's housing. Do not operate with an open housing.

6.1 Troubleshooting Tips

If the instrument fails to operate, check the batteries and the test leads, and replace as necessary. Double check the procedures outlined in this manual.

If the instrument's positive input terminal has been subjected to a high voltage transient (caused by lightning or a switching surge to the system under test), the impedance of the protective components in series might be compromised (creating a high impedance) and will act like an open fuse. Most measuring functions through this terminal might then be subject to an open circuit. Such components should only be replaced by a qualified technician.

6.2 Accuracy and Calibration

Accuracy is specified for a period of one year after calibration. Periodic calibration at intervals of one year is recommended to maintain meter accuracy.

6.3 Cleaning and Storage

Periodically wipe the case with a damp cloth and mild detergent; do not use abrasives or solvents. If the meter is not to be used for more than 60 days, remove the batteries and store them separately.

6.4 Battery Replacement

To avoid electrical shock, disconnect the meter if connected to a circuit, remove the probe leads from the terminals, and set the function switch to the OFF position before attempting to replace the batteries.

The rear battery compartment locking screw has a LOCK and UNLOCK position.

Replace the two (2) standard 1.5V AAA batteries, observing correct polarity.

Secure the battery compartment cover before use.

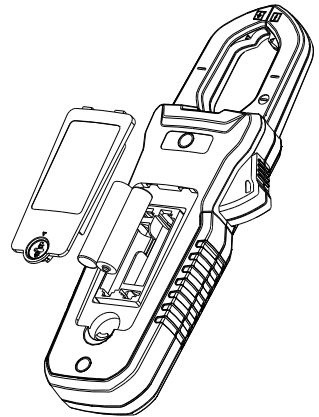

Figure 6-1 Battery installation

7. Specifications

7.1 General specifications

Display: 3-5/6 digits 6000 counts, backlit

Polarity: Automatic

Update Rate: 5 per second nominal

Operating Temperature: 14°F ~ 122°F (-10°C ~ 50°C)

Relative Humidity: Maximum relative humidity 80% for temperature up to 88°F (31°C) decreasing linearly to 50% relative humidity at 122°F (50°C)

Pollution degree: 2

Storage Temperature: -4°F ~ 140°F (-20°C ~ 60°C), < 80% R.H. (with battery removed)

Altitude: Operating 7000 ft. (2000 meters) Max.

Temperature Coefficient: nominal 0.15 x (specified accuracy)/ °C @ (32°F ~ 64.4°F [0°C ~ 18°C] or 82.4°F ~ 122°F [28°C ~ 50°C]), or as otherwise specified

Sensing: True RMS

Safety: Double insulation per UL/IEC/EN61010-1 Ed. 3.0, IEC/EN61010-2-033 Ed. 1.0, CAN/CSA C22.2 No. 61010-1 Ed. 3.0, IEC/EN61010-2-032 Ed. 3.0 & IEC/EN61010-031 Ed. 1.1 to CAT III 600V and CAT IV 300V AC & DC

Transient Protection: 6.0kV (1.2/50µs surge)

Drop test: 6.6 ft. (2m)

Overload Protection:

Current & Hz functions via jaws: 400ADC/AAC rms <400Hz

Voltage via terminals: 660VDC / 920VAC rms

Other functions via terminals: 600VDC/VAC rms

E.M.C.: Meets EN61326-1:2013:

Ohm functions for all Models & DCµA for CM44 & CM46:

In an RF field of 1V/m:

Total Accuracy = Specified Accuracy + 25 digits for OHM & DCµA

Other functions of all Models:

In an RF field of 3V/m: Total Accuracy = Specified Accuracy + 20 digits

Power Supply: 1.5V AAA size battery X 2

Power Consumption: 13mA for Current functions of Model CM46; 4.3mA for others

Low Battery:

Below approx. 2.85V for Capacitance & Hz functions

Below approx. 2.5V for other functions

APO Timing: 32 minutes of inactivity

APO Consumption: 5µA typical

Dimensions (LxWxH): 8.8 x 3.0 x 1.5 in. (223 x 76 x 37mm) for CM46; 8.5 x 3.0 x 1.5 in. (217 x 76 x 37mm) for CM42 and CM44

Weight: 8.3 oz. (234g) for Model CM46; 6.6 oz. (186g) for Models CM42 and CM44

Jaw opening & Conductor diameter: 1.2 in. (30mm) maximum

Accessories: Test lead set, Quick Start Guide, soft carrying pouch, banana plug K-type thermocouple (Models CM44 and CM46)

Optional purchase accessories: Banana plug to Type-K socket plug adaptor (Models CM44 and CM46)

Advanced Features: Accu-Tip™ low-current range; MAX/MIN/AVG Recording mode; Display Hold; EF-Detection (NCV); Backlit LCD; 80ms Peak-RMS mode for inrush current (CM46 & CM44 only); Relative/DC Zero (CM46 & CM44 only)

CAT	Application field
III	Distribution circuits, machinery, main switching devices close to switchgears, industrial installations and high current close to distribution circuits
IV	Installation sources, utility transformers, all outside conductors, counters, protective devices on primary sides and electricity meters

7.2 Electrical specifications

Accuracy: \pm (% reading + number of digits) or as otherwise specified, at 23°C (73.4°F) \pm 5°C (9°F).

DC Voltage

RANGE	Accuracy
600.0V	1.0% + 5d

Input Impedance: 10M Ω , 100 pF nominal

AC Voltage (with Digital Low-Pass Filter)

RANGE	Accuracy
50Hz ~ 60Hz	
600.0V	1.0% + 5d

Input Impedance: 10M Ω , 100 pF nominal

DC+AC Voltage (with Digital Low-Pass Filter) (Model CM46 only)

RANGE	Accuracy
DC, 50Hz ~ 60Hz	
600.0V	1.2% + 7d

Input Impedance: 10M Ω , 100 pF nominal

PEAK-rms (ACV & ACA for Models CM44 and CM46)

Response: 80ms to > 90%

Audible Continuity Tester

Audible Threshold: 10 Ω to 250 Ω

Response time: 32 milliseconds approx.

Resistance

RANGE	Accuracy
600.0 Ω , 6.000K Ω , 60.00K Ω	1.0% + 5d

Open Circuit Voltage: 1.7VDC typical

Capacitance (Models CM44 and CM46)

RANGE	Accuracy ¹
200.0 μ F, 2500 μ F	2.0% + 4d

¹ Accuracy specified for film capacitors or better

Diode Test

RANGE	Accuracy
2.000V	1.5% + 5d

Test Current: 0.3mA typical; Open Circuit Voltage: < 3.5VDC typical

DC μ A (Models CM44 and CM46)

RANGE	Accuracy	Burden Voltage
200.0 μ A, 2000 μ A	1.0% + 5d	3.5mV/ μ A

Temperature (Models CM44 and CM46)

RANGE ²	Accuracy ¹
-40.0 °C ~ 99.9 °C	1.0% + 1°C
100 °C ~ 400 °C	
-40.0 °F ~ 99.9 °F	1.0% + 2°F
100 °F ~ 752 °F	

¹ K-type thermocouple range & accuracy not included. Accuracies assume meter interior has the same temperature as the ambient temperature for correct junction voltage compensation. Allow adequate time for stabilization for significant changes of ambient temperature. Up to an hour, for changes > 5°C (9°F), may be required.

² Supplied thermocouple is rated for -20~250°C (-4~482°F) only, and therefore not rated for the entire specified temperature range of the meter.

Low current Accu-Tip™ clamp-on ACA

RANGE	Accuracy ^{1, 2, 3, 4}
50Hz ~ 60Hz	
60.00A	1.5% + 5d (CM46); 2.0% + 5d (CM42 and CM44)

¹ Induced error from adjacent current-carrying conductor:

<0.01A/A for Model CM46

<0.06A/A for Models CM42 and CM44

² Specified with Relative/DC Zero mode applied to offset non-zero residual readings

³ Add 10d to the specified accuracy @ < 4A

⁴ Position the conductor at the center of the Accu-Tip™ area. Conductor size must not exceed (0.35") 8.8mm.

Low current Accu-Tip™ clamp-on DCA (Model CM46)

RANGE	Accuracy ^{1, 2, 3, 4}
60.00A	2.0% + 5d

¹ Induced error from adjacent current-carrying conductor: <0.01A/A

² Specified with DC Zero mode applied to offset non-zero residual readings

³ Add 10d to the specified accuracy @ < 4A

⁴ Position the conductor at the center of the Accu-Tip™ area. Conductor size must not exceed (0.35") 8.8mm.

Low current Accu-Tip™ clamp-on DC+ACA (Model CM46)

RANGE	Accuracy ^{1, 2, 3, 4}
DC, 50Hz ~ 60Hz	
60.00A	2.0% + 7d

¹ Induced error from adjacent current-carrying conductor: <0.01A/A

² Specified with DC Zero mode applied to offset non-zero residual readings

³ Add 10d to the specified accuracy @ < 4A

⁴ Position the conductor at the center of the Accu-Tip™ area. Conductor size must not exceed (0.35") 8.8mm.

Standard Clamp-on ACA

RANGE	CM46 Accuracy ¹	CM42 and CM44 Accuracy ^{1, 2}
	50Hz ~ 100Hz	50Hz ~ 60Hz
60.00A ^{3, 4} , 400.0A	1.8% + 5d	2.0% + 5d
	100Hz ~ 400Hz	60Hz ~ 400Hz
60.00A ^{3, 4} , 400.0A	2.0% + 5d ⁵	3.0% + 5d ⁵

¹ Induced error from adjacent current-carrying conductor:

<0.01A/A for Models CM46

<0.06A/A for Models CM44 & CM42

² For CM44 & CM42, specified accuracy is for measurements made at the jaw center. When the conductor is not positioned at the jaw center, add 2% to specified accuracy for position errors

³ For CM44 & CM42, add 10d to specified accuracy @ < 6A

⁴ For CM46, add 10d to the specified accuracy @ < 9A

⁵ Add 3% to the accuracy specification for Crest Factor between 1.0 and 2.0. If the Crest Factor is > 2.0, the reading may not meet specified tolerances.

Standard Clamp-on DCA (Model CM46)

RANGE	Accuracy ^{1, 2}
60.00A ³ , 400.0A	2.0% + 5d

¹ Induced error from adjacent current-carrying conductor: <0.01A/A

² Specified with DC Zero mode applied to offset non-zero residual readings

³ Add 10d to the specified accuracy @ < 9A

Standard Clamp-on DC+ACA (Model CM46)

RANGE	Accuracy ^{1, 2}
DC, 50Hz ~ 100Hz	
60.00A ³ , 400.0A	2.2% + 7d
100Hz ~ 400Hz	
60.00A ³ , 400.0A	2.7% + 7d

¹ Induced error from adjacent current-carrying conductor: < 0.01A/A

² Specified with DC Zero mode applied to offset non-zero residual readings

³ Add 10d to the specified accuracy @ < 9A

Hz Line Level Frequency

Function	Sensitivity ¹ (Sine RMS)	Range
600V	50V	5.00Hz ~ 999.9Hz
60A (low current mode)	40A	50.00Hz ~ 400.0Hz
60A, 400A	40A	50.00Hz ~ 400.0Hz

Accuracy: 1%+5d

¹ DC-bias, if any, not more than 50% of Sine RMS

Non-Contact EF Voltage Detection

Typical Voltage	Bar Graph Indication
20V (tolerance: 10V ~ 36V)	-
55V (tolerance: 23V ~ 83V)	--
110V (tolerance: 59V ~ 165V)	---
220V (tolerance: 124V ~ 330V)	----
440V (tolerance: 250V ~ 600V)	-----

Indication: number of Bargraph segments & audible beep tones proportional to the detected field strength

Detection Frequency: 50/60Hz

Detector: Located inside the top of the stationary jaw

8. Technical Support

Main Website	http://www.flir.com/test
Technical Support Website	http://support.flir.com
Technical support Email	TMSupport@flir.com
Service/Repair Support Email	Repair@flir.com
Support Telephone number	+1 855-499-3662 option 3 (toll-free)

9. Warranty

FLIR Global Limited Lifetime Warranty

A qualifying FLIR Test and Measurement product (the "Product") purchased either directly from FLIR Commercial Systems Inc. and affiliates (FLIR) or from an authorized FLIR distributor or reseller that Purchaser registers on-line with FLIR is eligible for coverage under FLIR's Limited Lifetime Warranty, subject to the terms and conditions in this document. This warranty only applies to purchases of Qualifying Products (see below) purchased and manufactured after April 1, 2016.

PLEASE READ THIS DOCUMENT CAREFULLY; IT CONTAINS IMPORTANT INFORMATION ABOUT THE PRODUCTS THAT QUALIFY FOR COVERAGE UNDER THE LIMITED LIFETIME WARRANTY, PURCHASER'S OBLIGATIONS, HOW TO ACTIVATE THE WARRANTY, WARRANTY COVERAGE, AND OTHER IMPORTANT TERMS, CONDITIONS, EXCLUSIONS AND DISCLAIMERS.

- 1. PRODUCT REGISTRATION.** To qualify for FLIR's Limited Lifetime Warranty, Purchaser must fully register the Product directly with FLIR on-line at <http://www.flir.com> within Sixty (60) DAYS of the date the Product was purchased by the first retail customer (the "Purchase Date"). Qualifying PRODUCTS THAT ARE NOT REGISTERED ON-LINE WITHIN SIXTY (60) DAYS OF THE PURCHASE DATE WILL HAVE A LIMITED ONE YEAR WARRANTY FROM DATE OF PURCHASE.
- 2. QUALIFYING PRODUCTS.** Upon registration, Test and Measurement products that qualify for coverage under FLIR's Limited Lifetime Warranty are: MR7x, CM4x, CM7x, CM8x, DMxx, VP5x not including accessories which may have their own warranty.
- 3. WARRANTY PERIODS.** For purposes of The Limited Lifetime Warranty, Lifetime is defined as seven years (7) after the product is no longer manufactured, or ten years (10) from date of purchase, whichever is greater. This Warranty is only applicable to the original owner of the Products. Any Product that is repaired or replaced under warranty is covered under this Limited Lifetime Warranty for one hundred eighty days (180) days from the date of return shipment by FLIR or for the remaining duration of the applicable Warranty Period, whichever is longer.
- 4. LIMITED WARRANTY.** In accordance with the terms and conditions of this Limited Lifetime Warranty, and except as excluded or disclaimed in this document, FLIR warrants, from the Purchase Date, that all fully registered Products will conform to FLIR's published Product specifications and be free from defects in materials and workmanship during the applicable Warranty Period. PURCHASER'S SOLE AND EXCLUSIVE REMEDY UNDER THIS WARRANTY, AT FLIR'S SOLE DISCRETION, IS THE REPAIR OR REPLACEMENT OF DEFECTIVE PRODUCTS IN A MANNER, AND BY A SERVICE CENTER, AUTHORIZED BY FLIR. IF THIS REMEDY IS ADJUDICATED TO BE INSUFFICIENT, FLIR SHALL REFUND PURCHASER'S PAID PURCHASE PRICE AND HAVE NO OTHER OBLIGATION OR LIABILITY TO BUYER WHATSOEVER.
- 5. WARRANTY EXCLUSIONS AND DISCLAIMERS.** FLIR MAKES NO OTHER WARRANTY OF ANY KIND WITH RESPECT TO THE PRODUCTS. ALL OTHER WARRANTIES, EXPRESS OR IMPLIED, INCLUDING BUT NOT LIMITED TO IMPLIED WARRANTIES OF MERCHANTABILITY, FITNESS FOR A PARTICULAR PURPOSE (EVEN IF PURCHASER HAS NOTIFIED FLIR OF ITS INTENDED USE FOR THE PRODUCTS), AND NON-INFRINGEMENT ARE EXPRESSLY EXCLUDED FROM THIS AGREEMENT. THIS WARRANTY EXPRESSLY EXCLUDES ROUTINE PRODUCT MAINTENANCE, SOFTWARE UPDATES, AND REPLACEMENT OF MANUALS, FUSES, OR DISPOSABLE BATTERIES. FLIR FURTHER EXPRESSLY DISCLAIMS ANY WARRANTY COVERAGE WHERE THE ALLEGED NONCONFORMITY IS DUE TO NORMAL WEAR AND TEAR, OTHER ALTERATION, MODIFICATION, REPAIR, ATTEMPTED REPAIR, IMPROPER USE, IMPROPER MAINTENANCE, NEGLIGENCE, ABUSE, IMPROPER STORAGE, FAILURE TO FOLLOW ANY PRODUCT INSTRUCTIONS, DAMAGE (WHETHER CAUSED BY ACCIDENT OR OTHERWISE), OR ANY OTHER IMPROPER CARE OR HANDLING OF THE PRODUCTS CAUSED BY ANYONE OTHER THAN FLIR OR FLIR'S EXPRESSLY AUTHORIZED DESIGNEE. THIS DOCUMENT CONTAINS THE ENTIRE WARRANTY AGREEMENT BETWEEN PURCHASER AND FLIR AND SUPERSEDES ALL PRIOR WARRANTY NEGOTIATIONS, AGREEMENTS, PROMISES AND UNDERSTANDINGS BETWEEN PURCHASER AND FLIR. THIS WARRANTY MAY NOT BE ALTERED WITHOUT THE EXPRESS WRITTEN CONSENT OF FLIR.
- 6. WARRANTY RETURN, REPAIR AND REPLACEMENT.** To be eligible for warranty repair or replacement, Purchaser must notify FLIR within thirty (30) days of discovering of any apparent defect in materials or workmanship. Before Purchaser may return a Product for warranty service or repair, Purchaser must first obtain a returned material authorization (RMA) number from FLIR. To obtain the RMA number Owner must provide an original proof of purchase. For additional information, to notify FLIR of an apparent defect in materials or workmanship, or to request an RMA number, visit <http://www.flir.com>. Purchaser is solely responsible for complying with all RMA instructions provided by FLIR including but not limited to adequately packaging the Product for shipment to FLIR and for all packaging and shipping costs. FLIR will pay for returning to Purchaser any Product that FLIR repairs or replaces under warranty. FLIR reserves the right to determine, in its sole discretion, whether a returned Product is covered under Warranty. If FLIR determines that any returned Product is not covered under Warranty or is otherwise excluded from Warranty coverage, FLIR may charge Purchaser a reasonable handling fee and return the Product to Purchaser, at Purchaser's expense, or offer Purchaser the option of handling the Product as a non-warranty return.
- 7. NON-WARRANTY RETURN.** Purchaser may request that FLIR evaluate and service or repair a Product not covered under warranty, which FLIR may agree to do in its sole discretion. Before Purchaser returns a Product for non-warranty evaluation and repair, Purchaser must contact FLIR by visiting <http://www.flir.com> to request an evaluation and obtain an RMA. Purchaser is solely responsible for complying with all RMA instructions provided by FLIR including but not limited to adequately packaging the Product for shipment to FLIR and for all packaging and shipping costs. Upon receipt of an authorized non-warranty return, FLIR will evaluate the Product and contact Purchaser regarding the feasibility of and the costs and fees associated with Purchaser's request. Purchaser shall be responsible for the reasonable cost of FLIR's evaluation, for the cost of any repairs or services authorized by Purchaser, and for the cost of repackaging and returning the Product to Purchaser. Any non-warranty repair of a Product is warranted for one hundred eighty days (180) days from the date of return shipment by FLIR to be free from defects in materials and workmanship only, subject to all of the limitations, exclusions and disclaimers in this document.



Corporate Headquarters

FLIR Systems, Inc.
2770 SW Parkway Avenue
Wilsonville, OR 97070 USA
Telephone: +1 503-498-3547

Customer Support

Technical Support Website	http://support.flir.com
Technical Support Email	TMSupport@flir.com
Service and Repair Email	Repair@flir.com
Customer Support Telephone	+1 855-499-3662 option 3 (toll free)

Publication Identification No.:	CM4x-en-US
Release Version:	AA
Release Date:	2016 August
Language:	en-US